

# RIW

STEERING & SUSPENSION  
MANUFACTURER

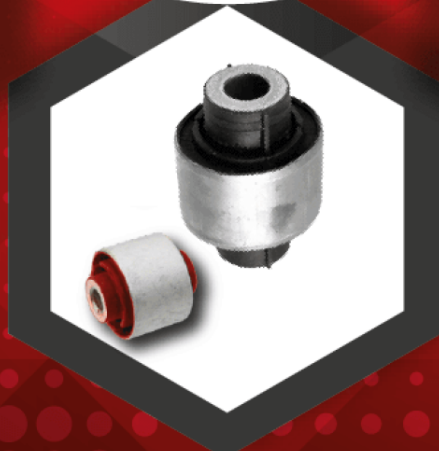

## CATALOGO DE PRODUCTOS



### Nosotros

RIW, es una empresa productora de alta calidad en autopartes de suspensión y dirección para vehículos de pasajeros y vehículos comerciales en el aftermarket de industria automotriz (además de ofrecer estándares de calidad a niveles OEM). RIW tiene como objetivo mejorar la industria automotriz además de beneficiar la economía del país, con el objetivo de brindar calidad total y por consecuencia el usuario final obtendrá seguridad en los productos RIW. Como uno de los fabricantes de partes de suspensión y dirección con la gama mas amplia del en el mundo, los equipos de producción y ensamble de RIW que operan en las líneas de productos de suspensión y dirección para el aftermarket; rotulas, terminales, vieletas, coples, tornillos estabilizadores, varillas centrales, horquillas, brazos, bujes, soportes de hule. Como resultado de una amplia gama de productos, alta calidad, precio razonable y estudios enfocados al cliente, RIW ocupa el primer lugar entre las empresas de repuestos automotrices mas grandes de Turquía. Mediante la ejecución del desarrollo e Investigación del desarrollo de la producción de productos de partes de suspensión y dirección de vehículos de turismo, comerciales y ligeros con las condiciones mas avanzadas en tecnología. RIW es el fabricante mas moderno en la producción de estas piezas de Turquía.

La cultura de la empresa tiene como prioridad la calidad del producto, el desarrollo tecnológico y la satisfacción del cliente; por lo tanto, la Industria del Aftermarket Automotriz utiliza el producto de la marca RIW con confianza. Aprovechando las ultimas tecnologías de maquinado en sus modernas instalaciones de producción y también tomando la seguridad de los empleados como el principal principio en cada etapa de la producción, desde su diseño hasta el producto terminado en empaque, la distribución y comercialización del producto. RIW ha logrado ser una marca respetable en el mercado de todo el mundo por mas de 60 países.

### Misión

Proporcionar al mercado el último desarrollo de producto en la mas alta calidad, así como ser el primero en el aftermarket y proveer productos de calidad en cada parte del mundo.

### Visión

Diffundir los "Estándares de RIW" que se logra mediante la tecnología avanzada y las experiencias de posventa para beneficiar a todo el mundo.

### Producción Estratégica

Los ingenieros de RIW controlan toda las etapas de los procesos de producción, como el diseño del producto, diseño de moldes, maquinado, forjado en caliente y frío, forjado de aluminio, fresado de brazo vertical y horizontal, fabricación de brazos de control para soldadura, pintura, revestimiento y empaque en cada una de sus instalaciones por separado. RIW adopta cada etapa de la producción como una unidad diferente y defiende la idea de que para poder proporcionar el producto de mayor calidad y mas rapidez, cada unidad debe actuar como un proceso por separado durante su planificación para el ensamble y la producción. Por lo tanto en las actuales condiciones del mercado competitivo donde es difícil alcanzar grandes números de capital, RIW invierte en la dirección del control de calidad y el desarrollo.

A diferencia de la mentalidad en cada proceso, la producción esta bajo el mismo techo. RIW se asegura que las materias primas y los productos semi-terminados sean inspeccionados continuamente por ingenieros experimentados y que siempre se mantenga con la calidad bajo control en cada etapa del proceso de producción, con este sistema, gracias a la ultima tecnología en maquinaria y equipos de prueba utilizados para aplicar las pruebas de calidad en cada etapa de la producción. RIW siempre ofrece productos 100% controlados a todos sus clientes y minimiza el riesgo de error a cero y pretende ofrecer precios competitivos a los clientes al disminuir los costos del producto.

### Calidad Total

RIW aspira a un enfoque de Calidad Total, ha aumentado constantemente su capacidad de producción con las inversiones y los trabajos de calidad realizados, se ha convertido en una marca preferida en el mercado del aftermarket mundial. Actuando con la conciencia de ser un fabricante de componentes de seguridad. RIW exporta alta calidad de productos a varios países localizados en Europa, Norte de África, Medio Oriente, Australia, América del Norte y América del Sur.

En todas las etapas desde el inicio hasta el final de la producción, RIW supervisa de cerca y comprueba la calidad de sus productos para ofrecer productos confiables y de alta calidad a sus clientes. Todas las pruebas y procedimientos son llevados a cabo por ingenieros altamente experimentados de RIW hasta que se encuentra la calidad adecuada para desarrollar en la industria del aftermarket.

- The codes which has 6 characters are suspension parts (Additional codes are exceptional)
- The codes which has 7 characters are rubber parts (Additional codes are exceptional)
- There is no any specific code for Rod Assembly.
- Rod Assembly codes are the combine of Tie Rod End and Axial Joint.
- Same parts which are used at the different cars might have the same code.

## PE 6 001 J

### Brand

<b>AC</b> ACURA	<b>DC</b> DACIA	<b>IS</b> ISUZU	<b>LE</b> LEYLAND	<b>PE</b> PEUGEOT	<b>SM</b> SMART
<b>AF</b> ALFA ROMEO	<b>DW</b> DAEWOO	<b>IV</b> IVECO	<b>LC</b> LINCOLN	<b>PO</b> PORSCHE	<b>SY</b> SSANGYONG
<b>AU</b> AUDI	<b>DH</b> DAIHATSU	<b>JG</b> JAGUAR	<b>LO</b> LOTUS	<b>PR</b> PROTON	<b>SU</b> SUBARU
<b>BW</b> BMW	<b>DO</b> DODGE	<b>JP</b> JEEP	<b>MZ</b> MAZDA	<b>RE</b> RENAULT	<b>SZ</b> SUZUKI
<b>BU</b> BUICK	<b>FI</b> FIAT	<b>KI</b> KIA	<b>ME</b> MERCEDES	<b>RR</b> ROLLS-ROYCE	<b>TO</b> TOYOTA
<b>CD</b> CADILLAC	<b>FO</b> FORD	<b>LD</b> LADA	<b>MC</b> MINI COOPER	<b>RO</b> ROVER	<b>VA</b> VAUXHALL
<b>CV</b> CHEVROLET	<b>HN</b> HONDA	<b>LR</b> LAND ROVER	<b>MI</b> MITSUBISHI	<b>SA</b> SAAB	<b>VW</b> VOLKSWAGEN
<b>CY</b> CHRYSLER	<b>HY</b> HYUNDAI	<b>LV</b> LDV	<b>NS</b> NISSAN	<b>SE</b> SEAT	<b>VO</b> VOLVO
<b>CI</b> CITROËN	<b>IK</b> IKCO	<b>LX</b> LEXUS	<b>OP</b> OPEL	<b>SK</b> SKODA	

PE

### Product Group

<b>1</b> BALL JOINT	<b>7</b> CENTER ROD & DRAG LINK	<b>23</b> TIE ROD ASSEMBLY
<b>2</b> TIE ROD END	<b>8</b> SUSPENSION KITS	<b>12</b> MOUNTING & RUBBER SUPPORT
<b>3</b> AXIAL JOINT (INNER TIE ROD)	<b>9</b> REAR WISHBONE AND CONTROL ARM	<b>128</b> MOUNTING or RUBBER SUPPORT KIT
<b>4</b> LINK STABILIZER	<b>10</b> BUSH	<b>13</b> BELLOW STEERING
<b>5</b> CONTROL ARM	<b>11</b> BUSH	<b>14</b> BELLOW DRIVE SHAFT
<b>6</b> WISHBONE	<b>118</b> REPAIR & BUSH KIT	

6

### Numbers

001 Any Number ■

### Option

#### ADDITIONALS CODES AND MEANINGS

<b>K</b> K FOR BALL JOINTS	<b>B</b> B FOR WISHBONE and CONTROL ARMS
VW1012K 1 = BALL JOINT K = WITH EXTRA ACCESSORIES	BW5005B 5 = CONTROL ARM B = WITHOUT BUSHING
VW1012 1 = BALL JOINT	BW5005 5 = CONTROL ARM (The similar as OE part)
<b>J</b> J FOR WISHBONES	<b>K</b> K FOR MOUNTINGS (RUBBER PARTS)
PE6001J 6 = WISHBONE J = WITHOUT BALL JOINT	CV12005K 12 = MOUNTING K = KIT, 2 PIECES or WITH EXTRA ACCESSORIES
PE6001 6 = WISHBONE (The similar as the OE part)	CV12005 12 = MOUNTING (The similar as OE part)
<b>K</b> K FOR WISHBONES or CONTROL ARMS (5,6 or 9)	<b>A</b> THE PRODUCT HAS DIFFERENT OPTION
BW6005K 6 = WISHBONE K = WITH EXTRA ACCESSORIES	FO4030A 4 = LINK STABILIZER A = OPTION (metal, rubber), plastic etc)
BW6005 6 = WISHBONE	FO4030 4 = LINK STABILIZER (The similar as OE part)

J

## TABLA DE CONTENIDO

MARCA	PAGÄ°NA	MARCA	PAGÄ°NA
ACURA	6 / 9	SAAB	385 / 387
ALFA ROMEO	10 / 11	SATURN	388 / 390
ALPINA	12 / 13	SCION	391 / 392
AMERICAN MOTORS	14 / 15	SEAT	393 / 402
AUDI	16 / 29	SKODA	403 / 411
BENTLEY	30 / 31	SMART	412 / 414
BMW	32 / 49	SOUEAST	415 / 416
BUICK	50 / 60	SUBARU	417 / 422
CADILLAC	61 / 69	SUZUKI	423 / 424
CHEVROLET	70 / 93	TOYOTA	425 / 442
CHRYSLER	94 / 97	VAUXHALL	443 / 456
CITROEN	98 / 104	VOLKSWAGEN	457 / 477
CUPRA	105 / 106	VOLVO	478 / 496
DACIA	107 / 108		
DAEWOO	109 / 110		
DODGE	111 / 124		
EAGLE	125 / 126		
EDSEL	127 / 128		
FIAT	129 / 162		
FORD	163 / 187		
GMC	188 / 194		
HONDA	195 / 201		
HUMMER	202 / 203		
HYUNDAI	204 / 212		
INFINITI	213 / 214		
ISUZU	215 / 216		
IVECO	217 / 218		
JAGUAR	219 / 223		
JEEP	224 / 231		
KIA	232 / 237		
LADA	238 / 239		
LAMBORGHINI	240 / 241		
LANCIA	242 / 243		
LAND ROVER	244 / 247		
LEXUS	248 / 256		
LINCOLN	257 / 264		
MAN	265 / 266		
MAZDA	267 / 273		
MERCEDES	274 / 286		
MERCURY	287 / 296		
MINI	297 / 299		
MITSUBISHI	300 / 308		
NISSAN	309 / 318		
OLDSMOBILE	319 / 327		
OPEL	328 / 345		
PEUGEOT	346 / 351		
PLYMOUTH	352 / 355		
PONTIAC	356 / 365		
PORSCHE	366 / 371		
RAM	372 / 374		
RENAULT	375 / 384		

**RIW<sup>®</sup>**

**ACURA**

**MDX YD2 2007 - 2013**

Imagen	Clave del Producto y Descripción	Detalles	OEM
	<b>AC6007</b> Horquilla & Tijera	Peso : 5,918 kg / 13.047 lb Tipo de Material : Aluminio	51350-STX-A04, 51350-STX-A07
	<b>AC6008</b> Horquilla & Tijera	Peso : 5,918 kg / 13.047 lb Tipo de Material : Aluminio	51360-STX-A04, 51360-STX-A07
	<b>AC9004</b> Horquilla & Tijera	Peso : 1,108 kg / 2.443 lb Tipo de Material : Tubo De Acero	04523STX000, 52345-STX-A00 52345-STX-A01, 52345-SZA-A02

**RL KA9 1996 - 2004**

Imagen	Clave del Producto y Descripción	Detalles	OEM
	<b>AC2002</b> Terminal Exterior	Peso : 1,021 kg / 2.251 lb Longitud : 245,5 mm / 9.67 inch	53540SW5003, 53540SZ3003 53540SZ5003
	<b>AC2003</b> Terminal Exterior	Peso : 1,021 kg / 2.251 lb Longitud : 245,5 mm / 9.67 inch	53560SW5003, 53560SZ3003 53560SZ5003
	<b>AC3004</b> Terminal interior	Peso : 0,338 kg / 0.745 lb Longitud : 120,7 mm / 4.75 inch	53010S00000, 53010SS000 53010SS0000, 53010SW5003

**TL UA1, UA3 1996 - 1998**

Imagen	Clave del Producto y Descripción	Detalles	OEM
	<b>AC2002</b> Terminal Exterior	Peso : 1,021 kg / 2.251 lb Longitud : 245,5 mm / 9.67 inch	53540SW5003, 53540SZ3003 53540SZ5003
	<b>AC2003</b> Terminal Exterior	Peso : 1,021 kg / 2.251 lb Longitud : 245,5 mm / 9.67 inch	53560SW5003, 53560SZ3003 53560SZ5003
	<b>AC3004</b> Terminal interior	Peso : 0,338 kg / 0.745 lb Longitud : 120,7 mm / 4.75 inch	53010S00000, 53010SS000 53010SS0000, 53010SW5003

\* Nombres de los vehículos, marcas, modelos, símbolos y logos, número OE y otros números de terceros en el sitio web y catálogo solo son con fines de referencia.

**TL UA6, UA7 2004 - 2008**

Imagen	Clave del Producto y Descripción	Detalles	OEM
	<b>AC6001</b> Horquilla & Tijera	Peso : 1,384 kg / 3.051 lb Tipo de Material : Chapa Metálica	51450SEPA02
	<b>AC6002</b> Horquilla & Tijera	Peso : 1,384 kg / 3.051 lb Tipo de Material : Chapa Metálica	51460SEPA02

**TL UA8, UA9 2009 - 2014**

Imagen	Clave del Producto y Descripción	Detalles	OEM
	<b>AC9002</b> Horquilla & Tijera	Peso : 0,862 kg / 1.900 lb Tipo de Material : Tubo De Acero	52340TA0A00
	<b>AC9003</b> Horquilla & Tijera	Peso : 0,862 kg / 1.900 lb Tipo de Material : Tubo De Acero	52345TA0A00

**TSX CU2 2009 - 2014**

Imagen	Clave del Producto y Descripción	Detalles	OEM
	<b>AC9002</b> Horquilla & Tijera	Peso : 0,862 kg / 1.900 lb Tipo de Material : Tubo De Acero	52340TA0A00
	<b>AC9003</b> Horquilla & Tijera	Peso : 0,862 kg / 1.900 lb Tipo de Material : Tubo De Acero	52345TA0A00

**ZDX 2009 - 2013**

Imagen	Clave del Producto y Descripción	Detalles	OEM
	<b>AC6007</b> Horquilla & Tijera	Peso : 5,918 kg / 13.047 lb Tipo de Material : Aluminio	51350-STX-A04, 51350-STX-A07
	<b>AC6008</b> Horquilla & Tijera	Peso : 5,918 kg / 13.047 lb Tipo de Material : Aluminio	51360-STX-A04, 51360-STX-A07

\* Nombres de los vehículos, marcas, modelos, símbolos y logos, número OE y otros números de terceros en el sitio web y catálogo solo son con fines de referencia.

**ZDX****2009 - 2013**

Imagen	Clave del Producto y Descripción	Detalles	OEM
	<b>AC9004</b> Horquilla & Tijera	Peso : 1,108 kg / 2.443 lb Tipo de Material : Tubo De Acero	04523STX000, 52345-STX-A00 52345-STX-A01, 52345-SZA-A02



**RIW<sup>®</sup>**

**ALFA ROMEO**

**GT** **2003 - 2010**

Imagen	Clave del Producto y Descripción	Detalles	OEM
	<b>AF2014</b> Terminal Exterior	Peso : 0,363 kg / 0.800 lb Longitud : 92 mm / 3.62 inch	6X0422812, 77364522
	<b>AF2015</b> Terminal Exterior	Peso : 0,363 kg / 0.800 lb Longitud : 92 mm / 3.62 inch	6X0422811, 77364521

**MITO** **955** **2008 - 2018**

Imagen	Clave del Producto y Descripción	Detalles	OEM
	<b>FI13016K</b> Cubre Polvo De Direccion	Peso : 0.164 kg / 0.362 lb	4066.95, 77363828 77364571

**RIW<sup>®</sup>**

**ALPINA**

**B7**

**G12**

**2016 -**

Imagen	Clave del Producto y Descripción	Detalles	OEM
	<p><b>BW4070</b> Tornillo Estabilizador</p>	<p>Peso : 0,335 kg / 0.739 lb Longitud : 179 mm / 7.05 inch Nota : xdrive</p>	<p>31306861485, 6861485</p>
	<p><b>BW4071</b> Tornillo Estabilizador</p>	<p>Peso : 0,190 kg / 0.419 lb Tipo de Material : Plastico Longitud : 197,4 mm / 7.77 inch</p>	<p>33506861482, 33506869096 6861482, 6869096</p>

\* Nombres de los vehículos, marcas, modelos, símbolos y logos, número OE y otros números de terceros en el sitio web y catálogo solo son con fines de referencia.

**RIW<sup>®</sup>**

**AMERICAN MOTORS**

**AMERICAN**
**1966 - 1968**

Imagen	Clave del Producto y Descripción	Detalles	OEM
	<b>CD4005</b> Tornillo Estabilizador	Peso : 0,220 kg / 0.485 lb Longitud : 145 mm / 5.71 inch	25679063, 3879218

**PACER**
**1975 - 1980**

Imagen	Clave del Producto y Descripción	Detalles	OEM
	<b>CD4005</b> Tornillo Estabilizador	Peso : 0,220 kg / 0.485 lb Longitud : 145 mm / 5.71 inch	25679063, 3879218

**REBEL**
**1967 - 1969**

Imagen	Clave del Producto y Descripción	Detalles	OEM
	<b>CD4005</b> Tornillo Estabilizador	Peso : 0,220 kg / 0.485 lb Longitud : 145 mm / 5.71 inch	25679063, 3879218

**RIW<sup>®</sup>**

**AUDI**

**100**
**1991 - 1994**

Imagen	Clave del Producto y Descripción	Detalles	OEM
	<b>AU11013K</b> Buje De Horquilla & Tijera	Chasis (Delantero / Trasero) : Delantero Posicion : Peso : 0,095 kg / 0.209 lb Nota : 2 Pieces	4A0407181, 4A0407181A

**A1**
**8X**
**2010 - 2019**

Imagen	Clave del Producto y Descripción	Detalles	OEM
	<b>AU11070</b> Buje De Horquilla & Tijera	Chasis (Delantero / Trasero) : Trasera Posicion : Inferior Peso : 0,100 kg / 0.220 lb	5Q0505171, 5Q0505311C 5Q0505311CSK, 5Q0505311D 5Q0505311DSK
	<b>VW12159</b> Buje De Eje	Chasis (Delantero / Trasero) : Trasera Posicion : Izquierda Y Derecha Peso : 0,130 kg / 0.287 lb	1K0505553, 1K0505553A
	<b>AU12024</b> Buje De Torsion	Chasis (Delantero / Trasero) : Trasera Posicion : Izquierda Y Derecha Peso : 0.557 kg / 1.228 lb	1K0505145F, 1K0505145H 1K0505145K

**A1**
**GBA**
**2018 -**

Imagen	Clave del Producto y Descripción	Detalles	OEM
	<b>VW3025</b> Terminal interior	Peso : 0,676 kg / 1.490 lb Longitud : 311 mm / 12.24 inch Tamaño de la Rosca : M14X1,5 Diámetro de Cuerda del Perno : M16X1,5	2Q0423810D
	<b>VW6063</b> Horquilla & Tijera	Peso : 3,004 kg / 6.623 lb Tipo de Material : Chapa Metálica	2Q0407152B
	<b>VW6063J</b> Horquilla & Tijera	Peso : 2,439 kg / 5.377 lb Tipo de Material : Chapa Metálica	2Q0407152B
	<b>VW6064</b> Horquilla & Tijera	Peso : 3,004 kg / 6.623 lb Tipo de Material : Chapa Metálica	2Q0407151B
	<b>VW6064J</b> Horquilla & Tijera	Peso : 2,439 kg / 5.377 lb Tipo de Material : Chapa Metálica	2Q0407151B

\* Nombres de los vehículos, marcas, modelos, símbolos y logos, número OE y otros números de terceros en el sitio web y catálogo solo son con fines de referencia.



**A1** **GBA** **2018 -**

Imagen	Clave del Producto y Descripción	Detalles	OEM
	<b>VW6065</b> Horquilla & Tijera	Peso : 3,57 kg / 7.871 lb Tipo de Material : Chapa Metálica	2Q0407152C
	<b>VW6065J</b> Horquilla & Tijera	Peso : 2,964 kg / 6.535 lb Tipo de Material : Chapa Metálica	2Q0407152C
	<b>VW6066</b> Horquilla & Tijera	Peso : 3,57 kg / 7.871 lb Tipo de Material : Chapa Metálica	2Q0407151C
	<b>VW6066J</b> Horquilla & Tijera	Peso : 2,964 kg / 6.535 lb Tipo de Material : Chapa Metálica	2Q0407151C

**VW8003 / Kit De Suspensi?n Y Direcci?n**





**A3**

**8L1**

**1996 - 2003**





**Piezas del Kit**

Imagen	RIW Codigo / Nombre	OEM	OEM	RIW Codigo / Nombre	Imagen
	<b>AU1014</b> R?tula Frontal Derecho Inferior	1J0407366A, 1J0407366AS 1J0407366B, 1J0407366C 1J0407366D, 1J0407366H	1J0407365A, 1J0407365B 1J0407365C, 1J0407365D	<b>AU1015</b> R?tula Frontal Inferior Izquierdo	
	<b>AU11002</b> Bujes Delantero	1J0407181, 1J0407181A	191407182, 357407182 357407182F	<b>AU11005</b> Bujes Frontal Central	
	<b>VW4011</b> Tornillo Estabilizador Delantero	1J0411315E, 1J0411315G 1J0422315G			

\* Nombres de los vehiculos, marcas, modelos, simbolos y logos, numero OE y otros numeros de terceros en el sitio web y catalogo solo son con fines de referencia.

A3		8L1		1996 - 2003
Imagen	Clave del Producto y Descripción	Detalles	OEM	
	<b>VW13002K</b> Cubre Polvo De Direccion	Peso : 0.2 kg / 0.441 lb	1J0422831, 1J0422831B 8N0422831	







A3		8P1		2003 - 2012
Imagen	Clave del Producto y Descripción	Detalles	OEM	
	<b>VW12159</b> Buje De Eje	Chasis (Delantero / Trasero) : Trasera Posicion : Izquierda Y Derecha Peso : 0,130 kg / 0.287 lb	1K0505553, 1K0505553A	
	<b>AU12024</b> Buje De Torsion	Chasis (Delantero / Trasero) : Trasera Posicion : Izquierda Y Derecha Peso : 0.557 kg / 1.228 lb	1K0505145F, 1K0505145H 1K0505145K	
	<b>VW13006K</b> Cubre Polvo De Direccion	Peso : 0.29 kg / 0.639 lb	1K0423831A, 5C0423831	

A3		8V1		2012 - 2020
Imagen	Clave del Producto y Descripción	Detalles	OEM	
	<b>AU11070</b> Buje De Horquilla & Tijera	Chasis (Delantero / Trasero) : Trasera Posicion : Inferior Peso : 0,100 kg / 0.220 lb	5Q0505171, 5Q0505311C 5Q0505311CSK, 5Q0505311D 5Q0505311DSK	
	<b>VW12159</b> Buje De Eje	Chasis (Delantero / Trasero) : Trasera Posicion : Izquierda Y Derecha Peso : 0,130 kg / 0.287 lb	1K0505553, 1K0505553A	
	<b>VW13006K</b> Cubre Polvo De Direccion	Peso : 0.29 kg / 0.639 lb	1K0423831A, 5C0423831	

A4		8K2, 8K5		2007 - 2015
Imagen	Clave del Producto y Descripción	Detalles	OEM	
	<b>AU5073</b> Horquilla & Tijera	Peso : 2,330 kg / 5.137 lb Tipo de Material : Aluminio	8K0407694AD, 8K0407694Q 8K0407694S, 8R0407694B 8R0407694D, 9A740769403	

\* Nombres de los vehiculos, marcas, modelos, simbolos y logos, numero OE y otros numeros de terceros en el sitio web y catalogo solo son con fines de referencia.



A4 8K2, 8K5 2007 - 2015			
Imagen	Clave del Producto y Descripción	Detalles	OEM
	<b>AU5074</b> Horquilla & Tijera	Peso : 2,330 kg / 5.137 lb Tipo de Material : Aluminio	8K0407693AD, 8K0407693Q 8K0407693S, 8R0407693B 8R0407693D, 9A740769303

A4 8W2, B9 2015 -			
Imagen	Clave del Producto y Descripción	Detalles	OEM
	<b>AU4035</b> Tornillo Estabilizador	Peso : 0,281 kg / 0.619 lb Longitud : 174,5 mm / 6.87 inch	4N0505465F, 8W0505465B
	<b>AU5071</b> Horquilla & Tijera	Peso : 2,150 kg / 4.740 lb Tipo de Material : Aluminio	8W0407694A, 8W0407694B 8WD407694
	<b>AU5072</b> Horquilla & Tijera	Peso : 2,150 kg / 4.740 lb Tipo de Material : Aluminio	8W0407693A, 8W0407693B 8WD407693
	<b>AU9020</b> Horquilla & Tijera	Peso : 0,708 kg / 1.561 lb Tipo de Material : Chapa Metálica	4M0505292D, 80A505292
	<b>AU9021</b> Horquilla & Tijera	Peso : 0,708 kg / 1.561 lb Tipo de Material : Chapa Metálica	4M0505291D, 80A505291
	<b>AU12025</b> Soporte De Amortiguador	Peso : 0.522 kg / 1.151 lb Nota : WITHOUT AWD	8W0513353

A5 8T3 2007 - 2017			
Imagen	Clave del Producto y Descripción	Detalles	OEM
	<b>AU5073</b> Horquilla & Tijera	Peso : 2,330 kg / 5.137 lb Tipo de Material : Aluminio	8K0407694AD, 8K0407694Q 8K0407694S, 8R0407694B 8R0407694D, 9A740769403
	<b>AU5074</b> Horquilla & Tijera	Peso : 2,330 kg / 5.137 lb Tipo de Material : Aluminio	8K0407693AD, 8K0407693Q 8K0407693S, 8R0407693B 8R0407693D, 9A740769303

\* Nombres de los vehículos, marcas, modelos, símbolos y logos, número OE y otros números de terceros en el sitio web y catálogo solo son con fines de referencia.

**A5 F5A, F53, F57 2016 -**

Imagen	Clave del Producto y Descripción	Detalles	OEM
	<b>AU4035</b> Tornillo Estabilizador	Peso : 0,281 kg / 0.619 lb Longitud : 174,5 mm / 6.87 inch	4N0505465F, 8W0505465B
	<b>AU5071</b> Horquilla & Tijera	Peso : 2,150 kg / 4.740 lb Tipo de Material : Aluminio	8W0407694A, 8W0407694B 8WD407694
	<b>AU5072</b> Horquilla & Tijera	Peso : 2,150 kg / 4.740 lb Tipo de Material : Aluminio	8W0407693A, 8W0407693B 8WD407693
	<b>AU9020</b> Horquilla & Tijera	Peso : 0,708 kg / 1.561 lb Tipo de Material : Chapa Metálica	4M0505292D, 80A505292
	<b>AU9021</b> Horquilla & Tijera	Peso : 0,708 kg / 1.561 lb Tipo de Material : Chapa Metálica	4M0505291D, 80A505291

**A6 4A, 4C 1994 - 1997**





Imagen	Clave del Producto y Descripción	Detalles	OEM
	<b>AU11013K</b> Buje De Horquilla & Tijera	Chasis (Delantero / Trasero) : Delantero Posicion : Peso : 0,095 kg / 0.209 lb Nota : 2 Pieces	4A0407181, 4A0407181A

**A6 4A, C8 2018 -**

Imagen	Clave del Producto y Descripción	Detalles	OEM
	<b>AU4035</b> Tornillo Estabilizador	Peso : 0,281 kg / 0.619 lb Longitud : 174,5 mm / 6.87 inch	4N0505465F, 8W0505465B
	<b>AU5075</b> Horquilla & Tijera	Peso : 0.55 kg / 1.213 lb Tipo de Material : Aluminio	4M0407510B, 4M0407510C 80A407510A
	<b>AU5076</b> Horquilla & Tijera	Peso : 0.55 kg / 1.213 lb Tipo de Material : Aluminio	4M0407509B, 4M0407509C 80A407509A

\* Nombres de los vehículos, marcas, modelos, símbolos y logos, número OE y otros números de terceros en el sitio web y catálogo solo son con fines de referencia.

**A6 4A, C8 2018 -**

Imagen	Clave del Producto y Descripción	Detalles	OEM
	<b>AU5077</b> Horquilla & Tijera	Peso : 0,56 kg / 1.235 lb Tipo de Material : Aluminio	4M0407506B, 4M0407506C 80A407506A
	<b>AU5078</b> Horquilla & Tijera	Peso : 0,56 kg / 1.235 lb Tipo de Material : Aluminio	4M0407505B, 4M0407505C 80A407505A
	<b>AU9018</b> Horquilla & Tijera	Peso : 1,150 kg / 2.535 lb Tipo de Material : Chapa Metálica	4M0501530N, 80A501530A
	<b>AU9019</b> Horquilla & Tijera	Peso : 1,150 kg / 2.535 lb Tipo de Material : Chapa Metálica	4M0501529N, 80A501529A





**A8 4H 2010 - 2018**

Imagen	Clave del Producto y Descripción	Detalles	OEM
	<b>AU4034</b> Tornillo Estabilizador	Peso : 0,170 kg / 0.375 lb Nota : FOR ARMoured VEHICLES	4H6411317A

**A8 4N 2018 -**

Imagen	Clave del Producto y Descripción	Detalles	OEM
	<b>AU1022</b> Rotula	Peso : 0,580 kg / 1.279 lb	4M0407689B, 4M0407689C
	<b>AU5079</b> Horquilla & Tijera	Peso : 1,527 kg / 3.366 lb Tipo de Material : Aluminio	4M0407152D, 4M0407152F 4M0407152H
	<b>AU5080</b> Horquilla & Tijera	Peso : 1,527 kg / 3.366 lb Tipo de Material : Aluminio	4M0407151D, 4M0407151F 4M0407151H

**E-TRON**
**2018 -**

Imagen	Clave del Producto y Descripción	Detalles	OEM
	<b>AU1022</b> Rotula	Peso : 0,580 kg / 1.279 lb	4M0407689B, 4M0407689C
	<b>AU5075</b> Horquilla & Tijera	Peso : 0.55 kg / 1.213 lb Tipo de Material : Aluminio	4M0407510B, 4M0407510C 80A407510A
	<b>AU5076</b> Horquilla & Tijera	Peso : 0.55 kg / 1.213 lb Tipo de Material : Aluminio	4M0407509B, 4M0407509C 80A407509A
	<b>AU5079</b> Horquilla & Tijera	Peso : 1,527 kg / 3.366 lb Tipo de Material : Aluminio	4M0407152D, 4M0407152F 4M0407152H
	<b>AU5080</b> Horquilla & Tijera	Peso : 1,527 kg / 3.366 lb Tipo de Material : Aluminio	4M0407151D, 4M0407151F 4M0407151H









**Q2**
**GA**
**2017 - 2023**

Imagen	Clave del Producto y Descripción	Detalles	OEM
	<b>AU11070</b> Buje De Horquilla & Tijera	Chasis (Delantero / Trasero) : Trasera Posicion : Inferior Peso : 0,100 kg / 0.220 lb	5Q0505171, 5Q0505311C 5Q0505311CSK, 5Q0505311D 5Q0505311DSK

**Q3**
**8U**
**2011 - 2016**

Imagen	Clave del Producto y Descripción	Detalles	OEM
	<b>VW12159</b> Buje De Eje	Chasis (Delantero / Trasero) : Trasera Posicion : Izquierda Y Derecha Peso : 0,130 kg / 0.287 lb	1K0505553, 1K0505553A
	<b>AU12024</b> Buje De Torsion	Chasis (Delantero / Trasero) : Trasera Posicion : Izquierda Y Derecha Peso : 0.557 kg / 1.228 lb	1K0505145F, 1K0505145H 1K0505145K
	<b>VW13006K</b> Cubre Polvo De Direccion	Peso : 0.29 kg / 0.639 lb	1K0423831A, 5C0423831

\* Nombres de los vehiculos, marcas, modelos, simbolos y logos, numero OE y otros numeros de terceros en el sitio web y catalogo solo son con fines de referencia.

Q5		80A		2018 -	
Imagen	Clave del Producto y Descripción	Detalles	OEM		
	<b>AU4035</b> Tornillo Estabilizador	Peso : 0,281 kg / 0.619 lb Longitud : 174,5 mm / 6.87 inch	4N0505465F, 8W0505465B		
	<b>AU5075</b> Horquilla & Tijera	Peso : 0.55 kg / 1.213 lb Tipo de Material : Aluminio	4M0407510B, 4M0407510C 80A407510A		
	<b>AU5076</b> Horquilla & Tijera	Peso : 0.55 kg / 1.213 lb Tipo de Material : Aluminio	4M0407509B, 4M0407509C 80A407509A		
	<b>AU5077</b> Horquilla & Tijera	Peso : 0.56 kg / 1.235 lb Tipo de Material : Aluminio	4M0407506B, 4M0407506C 80A407506A		
	<b>AU5078</b> Horquilla & Tijera	Peso : 0.56 kg / 1.235 lb Tipo de Material : Aluminio	4M0407505B, 4M0407505C 80A407505A		
	<b>AU9018</b> Horquilla & Tijera	Peso : 1,150 kg / 2.535 lb Tipo de Material : Chapa Metálica	4M0501530N, 80A501530A		
	<b>AU9019</b> Horquilla & Tijera	Peso : 1,150 kg / 2.535 lb Tipo de Material : Chapa Metálica	4M0501529N, 80A501529A		
	<b>AU9020</b> Horquilla & Tijera	Peso : 0,708 kg / 1.561 lb Tipo de Material : Chapa Metálica	4M0505292D, 80A505292		
	<b>AU9021</b> Horquilla & Tijera	Peso : 0,708 kg / 1.561 lb Tipo de Material : Chapa Metálica	4M0505291D, 80A505291		







Q5		8R		2009 - 2017	
Imagen	Clave del Producto y Descripción	Detalles	OEM		
	<b>AU5073</b> Horquilla & Tijera	Peso : 2,330 kg / 5.137 lb Tipo de Material : Aluminio	8K0407694AD, 8K0407694Q 8K0407694S, 8R0407694B 8R0407694D, 9A740769403		

\* Nombres de los vehículos, marcas, modelos, símbolos y logos, número OE y otros números de terceros en el sitio web y catálogo solo son con fines de referencia.













Q5		8R		2009 - 2017	
Imagen	Clave del Producto y Descripción	Detalles	OEM		
	<b>AU5074</b> Horquilla & Tijera	Peso : 2,330 kg / 5.137 lb Tipo de Material : Aluminio	8K0407693AD, 8K0407693Q 8K0407693S, 8R0407693B 8R0407693D, 9A740769303		

Q7		4LB		2006 - 2016	
Imagen	Clave del Producto y Descripción	Detalles	OEM		
	<b>VW6067</b> Horquilla & Tijera	Peso : 8,834 kg / 19.476 lb Tipo de Material : Döküm Çelik	7L0407152F, 7L0407152J 7L0407152K, 95534101860 95534101861		
	<b>VW6068</b> Horquilla & Tijera	Peso : 8,834 kg / 19.476 lb Tipo de Material : Döküm Çelik	7L0407151F, 7L0407151J 7L0407151K, 95534101760 95534101761		

Q7		4MB		2015 -	
Imagen	Clave del Producto y Descripción	Detalles	OEM		
	<b>AU1022</b> Rotula	Peso : 0,580 kg / 1.279 lb	4M0407689B, 4M0407689C		
	<b>AU5075</b> Horquilla & Tijera	Peso : 0.55 kg / 1.213 lb Tipo de Material : Aluminio	4M0407510B, 4M0407510C 80A407510A		
	<b>AU5076</b> Horquilla & Tijera	Peso : 0.55 kg / 1.213 lb Tipo de Material : Aluminio	4M0407509B, 4M0407509C 80A407509A		
	<b>AU5077</b> Horquilla & Tijera	Peso : 0.56 kg / 1.235 lb Tipo de Material : Aluminio	4M0407506B, 4M0407506C 80A407506A		
	<b>AU5078</b> Horquilla & Tijera	Peso : 0.56 kg / 1.235 lb Tipo de Material : Aluminio	4M0407505B, 4M0407505C 80A407505A		
	<b>AU5079</b> Horquilla & Tijera	Peso : 1,527 kg / 3.366 lb Tipo de Material : Aluminio	4M0407152D, 4M0407152F 4M0407152H		





\* Nombres de los vehículos, marcas, modelos, símbolos y logos, número OE y otros números de terceros en el sitio web y catálogo solo son con fines de referencia.

Q7		4MB		2015 -	
Imagen	Clave del Producto y Descripción	Detalles	OEM		
	<b>AU5080</b> Horquilla & Tijera	Peso : 1,527 kg / 3.366 lb Tipo de Material : Aluminio	4M0407151D, 4M0407151F 4M0407151H		
	<b>AU9018</b> Horquilla & Tijera	Peso : 1,150 kg / 2.535 lb Tipo de Material : Chapa Metálica	4M0501530N, 80A501530A		
	<b>AU9019</b> Horquilla & Tijera	Peso : 1,150 kg / 2.535 lb Tipo de Material : Chapa Metálica	4M0501529N, 80A501529A		
	<b>AU9020</b> Horquilla & Tijera	Peso : 0,708 kg / 1.561 lb Tipo de Material : Chapa Metálica	4M0505292D, 80A505292		
	<b>AU9021</b> Horquilla & Tijera	Peso : 0,708 kg / 1.561 lb Tipo de Material : Chapa Metálica	4M0505291D, 80A505291		

Q8		4MN		2019 -	
Imagen	Clave del Producto y Descripción	Detalles	OEM		
	<b>AU5077</b> Horquilla & Tijera	Peso : 0.56 kg / 1.235 lb Tipo de Material : Aluminio	4M0407506B, 4M0407506C 80A407506A		
	<b>AU5078</b> Horquilla & Tijera	Peso : 0.56 kg / 1.235 lb Tipo de Material : Aluminio	4M0407505B, 4M0407505C 80A407505A		
	<b>AU5079</b> Horquilla & Tijera	Peso : 1,527 kg / 3.366 lb Tipo de Material : Aluminio	4M0407152D, 4M0407152F 4M0407152H		
	<b>AU5080</b> Horquilla & Tijera	Peso : 1,527 kg / 3.366 lb Tipo de Material : Aluminio	4M0407151D, 4M0407151F 4M0407151H		
	<b>AU9018</b> Horquilla & Tijera	Peso : 1,150 kg / 2.535 lb Tipo de Material : Chapa Metálica	4M0501530N, 80A501530A		





\* Nombres de los vehículos, marcas, modelos, símbolos y logos, número OE y otros números de terceros en el sitio web y catálogo solo son con fines de referencia.

Q8		4MN		2019 -
Imagen	Clave del Producto y Descripción	Detalles	OEM	
	<b>AU9019</b> Horquilla & Tijera	Peso : 1,150 kg / 2.535 lb Tipo de Material : Chapa Metálica	4M0501529N, 80A501529A	

TT		8J3		2006 - 2014
Imagen	Clave del Producto y Descripción	Detalles	OEM	
	<b>AU6019J</b> Horquilla & Tijera	Peso : 3,036 kg / 6.693 lb Tipo de Material : Aluminio	8J0407151D, 8J0407152D	
	<b>VW12159</b> Buje De Eje	Chasis (Delantero / Trasero) : Trasera Posicion : Izquierda Y Derecha Peso : 0,130 kg / 0.287 lb	1K0505553, 1K0505553A	
	<b>AU12024</b> Buje De Torsion	Chasis (Delantero / Trasero) : Trasera Posicion : Izquierda Y Derecha Peso : 0.557 kg / 1.228 lb	1K0505145F, 1K0505145H 1K0505145K	
	<b>VW13006K</b> Cubre Polvo De Direccion	Peso : 0.29 kg / 0.639 lb	1K0423831A, 5C0423831	

TT		FV3		2015 -
Imagen	Clave del Producto y Descripción	Detalles	OEM	
	<b>AU3016</b> Terminal interior	Peso : 0,565 kg / 1.246 lb Longitud : 212.5 mm / 8.37 inch	8S0423810A	
	<b>AU6019J</b> Horquilla & Tijera	Peso : 3,036 kg / 6.693 lb Tipo de Material : Aluminio	8J0407151D, 8J0407152D	
	<b>AU11070</b> Buje De Horquilla & Tijera	Chasis (Delantero / Trasero) : Trasera Posicion : Inferior Peso : 0,100 kg / 0.220 lb	5Q0505171, 5Q0505311C 5Q0505311CSK, 5Q0505311D 5Q0505311DSK	

**TT ROADSTER**
**8J9**
**2007 - 2014**

Imagen	Clave del Producto y Descripción	Detalles	OEM
	<b>AU6019J</b> Horquilla & Tijera	Peso : 3,036 kg / 6.693 lb Tipo de Material : Aluminio	8J0407151D, 8J0407152D
	<b>VW12159</b> Buje De Eje	Chasis (Delantero / Trasero) : Trasera Posicion : Izquierda Y Derecha Peso : 0,130 kg / 0.287 lb	1K0505553, 1K0505553A
	<b>AU12024</b> Buje De Torsion	Chasis (Delantero / Trasero) : Trasera Posicion : Izquierda Y Derecha Peso : 0.557 kg / 1.228 lb	1K0505145F, 1K0505145H 1K0505145K
	<b>VW13006K</b> Cubre Polvo De Direccion	Peso : 0.29 kg / 0.639 lb	1K0423831A, 5C0423831

**TT ROADSTER**
**FV9**
**2015 -**

Imagen	Clave del Producto y Descripción	Detalles	OEM
	<b>AU3016</b> Terminal interior	Peso : 0,565 kg / 1.246 lb Longitud : 212.5 mm / 8.37 inch	8S0423810A
	<b>AU6019J</b> Horquilla & Tijera	Peso : 3,036 kg / 6.693 lb Tipo de Material : Aluminio	8J0407151D, 8J0407152D
	<b>AU11070</b> Buje De Horquilla & Tijera	Chasis (Delantero / Trasero) : Trasera Posicion : Inferior Peso : 0,100 kg / 0.220 lb	5Q0505171, 5Q0505311C 5Q0505311CSK, 5Q0505311D 5Q0505311DSK

**RIW<sup>®</sup>**

**BENTLEY**

**BENTAYGA**
**4V1**
**2015 -**

Imagen	Clave del Producto y Descripción	Detalles	OEM
	<b>AU5075</b> Horquilla & Tijera	Peso : 0.55 kg / 1.213 lb Tipo de Material : Aluminio	4M0407510B, 4M0407510C 80A407510A
	<b>AU5076</b> Horquilla & Tijera	Peso : 0.55 kg / 1.213 lb Tipo de Material : Aluminio	4M0407509B, 4M0407509C 80A407509A
	<b>AU5077</b> Horquilla & Tijera	Peso : 0.56 kg / 1.235 lb Tipo de Material : Aluminio	4M0407506B, 4M0407506C 80A407506A
	<b>AU5078</b> Horquilla & Tijera	Peso : 0.56 kg / 1.235 lb Tipo de Material : Aluminio	4M0407505B, 4M0407505C 80A407505A

**RIW<sup>®</sup>**

**BMW**

**1 SERIES F20, F21 2011 - 2017**

Imagen	Clave del Producto y Descripción	Detalles	OEM
	<b>BW3011</b> Terminal interior	Peso : 0,562 kg / 1.239 lb Longitud : 248.5 mm / 9.78 inch Tamaño de la Rosca : M16X1,5 Diámetro de Cuerda del Perno : M14X1,5	32106792029*, 32106792030*
	<b>BW20383011</b> Terminales Completas	Peso : 1,331 kg / 2.934 lb Terminal Exterior : BW2038 Terminal Interior : BW3011	32106792030, 6792030
	<b>BW20393011</b> Terminales Completas	Peso : 1,331 kg / 2.934 lb Terminal Exterior : BW2039 Terminal Interior : BW3011	32106792029, 6792029

**2 SERIES F22, F23, F87 2014 -**

Imagen	Clave del Producto y Descripción	Detalles	OEM
	<b>BW3011</b> Terminal interior	Peso : 0,562 kg / 1.239 lb Longitud : 248.5 mm / 9.78 inch Tamaño de la Rosca : M16X1,5 Diámetro de Cuerda del Perno : M14X1,5	32106792029*, 32106792030*
	<b>BW20383011</b> Terminales Completas	Peso : 1,331 kg / 2.934 lb Terminal Exterior : BW2038 Terminal Interior : BW3011	32106792030, 6792030
	<b>BW20393011</b> Terminales Completas	Peso : 1,331 kg / 2.934 lb Terminal Exterior : BW2039 Terminal Interior : BW3011	32106792029, 6792029



**BW8009 / Kit De Suspension Y Direccion**

**3 SERIES**

**E36, Z3**

**1990 - 1998**



**Piezas del Kit**





Imagen	RIWCodigo / Nombre	OEM	OEM	RIWCodigo / Nombre	Imagen
	<b>BW11025</b> Bujes Derecha	31121136532	21121136531, 31121136531	<b>BW11026</b> Bujes Izquierdo	
	<b>BW20073817</b> Terminales Completas Frontal Derecho	32111139316	32111139315	<b>BW20083817</b> Terminales Completas Frontal Izquierdo	
	<b>BW4005</b> Tornillo Estabilizador Delantero	31351091764, 31351127689 31351128737	31121094276, 31121136530 31121140400, 31121140958 31126758514, 31126758516	<b>BW6003</b> Horquillas Frontal Derecho Inferior	
	<b>BW6004</b> Horquillas Frontal Inferior Izquierdo	31121094275, 31121136529 31121140399, 31121140957 31126758513, 31126758515			

\* Nombres de los vehiculos, marcas, modelos, simbolos y logos, numero OE y otros numeros de terceros en el sitio web y catalogo solo son con fines de referencia.

**3 SERIES**
**E36, Z3**
**1990 - 1998**

Imagen	Clave del Producto y Descripción	Detalles	OEM
	<b>BW11802</b> BUJES	Posicion : Izquierda Y Derecha Peso : 1,390 kg / 3.064 lb Nota : KIT = BW11025 and BW11026	21121136531, 31121136532

**3 SERIES**
**E46**
**1998 - 2005**

Imagen	Clave del Producto y Descripción	Detalles	OEM
	<b>BW1017</b> Rotula	Peso : 1,061 kg / 2.339 lb	1140356, 31121140356 31126756696, 6756696
	<b>BW1018</b> Rotula	Peso : 1,061 kg / 2.339 lb	1140355, 31121140355 31126756695, 6756695
	<b>BW2043</b> Terminal Exterior	Peso : 0,648 kg / 1.429 lb Longitud : 193 mm / 7.60 inch	32106774319, 32106774321 32216751040, 32216751042
	<b>BW2044</b> Terminal Exterior	Peso : 0,648 kg / 1.429 lb Longitud : 193 mm / 7.60 inch	32106774320, 32216751041
	<b>BW3013</b> Terminal interior	Peso : 0,450 kg / 0.992 lb Longitud : 197,4 mm / 7.77 inch	32106774318*, 32106774319*

**BW8010 / Kit De Suspension Y Direccion**





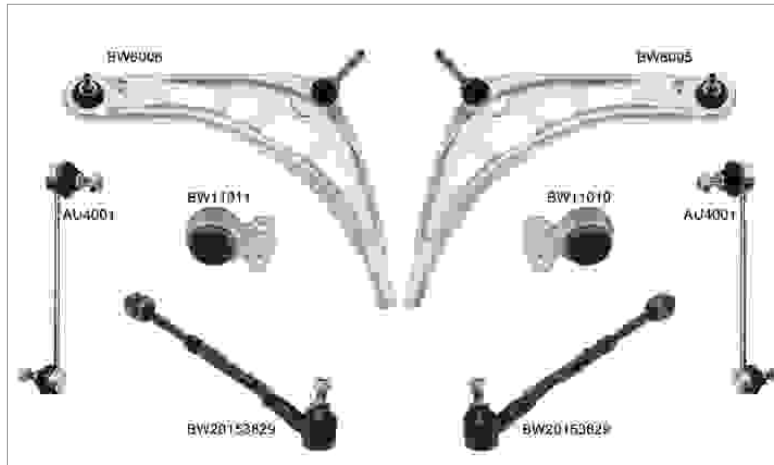

**3 SERIES**

**E46**

**1998 - 2005**



**Piezas del Kit**

Imagen	RIWCodigo / Nombre	OEM	OEM	RIWCodigo / Nombre	Imagen
	<b>AU4001</b> Tornillo Estabilizador Delantero	893407465, 893407465A 8A0407465, 8A0407465B 8A0407465C	31126756064, 31126757623	<b>BW11010</b> Bujes Derecha	
	<b>BW11011</b> Bujes Izquierdo	31126756063, 31126757623	32106777504, 32211095956 32211096898	<b>BW20153829</b> Terminales Completas Frontal Derecho	
	<b>BW20163829</b> Terminales Completas Frontal Izquierdo	32106777503, 32211095955 32211096897	31121094466, 31126751318 31126752318, 31126752718 31126758520	<b>BW6005</b> Horquillas Frontal Derecho Inferior	
	<b>BW6006</b> Horquillas Frontal Inferior Izquierdo	31121094465, 31121096985 31122343353, 31122343359 31126750223, 31126751317 31126752717, 31126758519 31126770247, 31126774819			

\* Nombres de los vehiculos, marcas, modelos, simbolos y logos, numero OE y otros numeros de terceros en el sitio web y catalogo solo son con fines de referencia.

**3 SERIES E46 1998 - 2005**

Imagen	Clave del Producto y Descripción	Detalles	OEM
	<b>BW20433013</b> Terminales Completas	Peso : 1,160 kg / 2.557 lb Terminal Exterior : BW2043 Terminal Interior : BW3013	32106774319
	<b>BW20443013</b> Terminales Completas	Peso : 1,160 kg / 2.557 lb Terminal Exterior : BW2044 Terminal Interior : BW3013	32106774318
	<b>VW13002K</b> Cubre Polvo De Direccion	Peso : 0.2 kg / 0.441 lb	1J0422831, 1J0422831B 8N0422831

**3 SERIES F30, F80 2011 - 2019**

Imagen	Clave del Producto y Descripción	Detalles	OEM
	<b>BW3011</b> Terminal interior	Peso : 0,562 kg / 1.239 lb Longitud : 248.5 mm / 9.78 inch Tamaño de la Rosca : M16X1,5 Diámetro de Cuerda del Perno : M14X1,5	32106792029*, 32106792030*
	<b>BW20383011</b> Terminales Completas	Peso : 1,331 kg / 2.934 lb Terminal Exterior : BW2038 Terminal Interior : BW3011	32106792030, 6792030
	<b>BW20393011</b> Terminales Completas	Peso : 1,331 kg / 2.934 lb Terminal Exterior : BW2039 Terminal Interior : BW3011	32106792029, 6792029

**4 SERIES F32, F33, F84 2014 - 2020**

Imagen	Clave del Producto y Descripción	Detalles	OEM
	<b>BW3011</b> Terminal interior	Peso : 0,562 kg / 1.239 lb Longitud : 248.5 mm / 9.78 inch Tamaño de la Rosca : M16X1,5 Diámetro de Cuerda del Perno : M14X1,5	32106792029*, 32106792030*
	<b>BW20383011</b> Terminales Completas	Peso : 1,331 kg / 2.934 lb Terminal Exterior : BW2038 Terminal Interior : BW3011	32106792030, 6792030
	<b>BW20393011</b> Terminales Completas	Peso : 1,331 kg / 2.934 lb Terminal Exterior : BW2039 Terminal Interior : BW3011	32106792029, 6792029

\* Nombres de los vehículos, marcas, modelos, símbolos y logos, número OE y otros números de terceros en el sitio web y catálogo solo son con fines de referencia.



**5 SERIES E39 523i, 528i 1995 - 2003**

Imagen	Clave del Producto y Descripción	Detalles	OEM
	<b>BW11019K</b> Buje De Horquilla & Tijera	Posicion : Peso : 0,25 kg / 0.551 lb Nota : 2 Pieces	23300200501, 23309200501 31121092010, 31129068753

**5 SERIES E60, E61 2003 - 2010**





Imagen	Clave del Producto y Descripción	Detalles	OEM
	<b>BW5085</b> Horquilla & Tijera	Peso : 2,050 kg / 4.519 lb Tipo de Material : Aluminio	31106770686, 31196770686 6770686
	<b>BW5086</b> Horquilla & Tijera	Peso : 2,050 kg / 4.519 lb Tipo de Material : Aluminio	31106770685, 31196770685 6770685

**5 SERIES G30, G31, G38 2017 - 2023**





Imagen	Clave del Producto y Descripción	Detalles	OEM
	<b>BW2041</b> Terminal Exterior	Peso : 0,769 kg / 1.695 lb	32106868687, 32106869538 32106881535
	<b>BW2042</b> Terminal Exterior	Peso : 0,769 kg / 1.695 lb	32106868685, 32106869536 32106881534
	<b>BW3012</b> Terminal interior	Peso : 0,500 kg / 1.102 lb	32106868688*, 32106868689* 32106869535*, 32106869537* 6868688*, 6868689* 6869535*, 6869537*
	<b>BW20413012</b> Terminales Completas	Peso : 1,269 kg / 2.798 lb Terminal Exterior : BW2041 Terminal Interior : BW3012	32106868689, 6868689
	<b>BW20423012</b> Terminales Completas	Peso : 1,269 kg / 2.798 lb Terminal Exterior : BW2042 Terminal Interior : BW3012	32106868688, 6868688
	<b>BW4069</b> Tornillo Estabilizador	Peso : 0,362 kg / 0.798 lb Longitud : 242 mm / 9.53 inch Nota : RWD	31306861483

\* Nombres de los vehículos, marcas, modelos, símbolos y logos, número OE y otros números de terceros en el sitio web y catálogo solo son con fines de referencia.

**5 SERIES**
**G30, G31, G38**
**2017 - 2023**

Imagen	Clave del Producto y Descripción	Detalles	OEM
	<b>BW4070</b> Tornillo Estabilizador	Peso : 0,335 kg / 0.739 lb Longitud : 179 mm / 7.05 inch Nota : xdrive	31306861485, 6861485
	<b>BW4071</b> Tornillo Estabilizador	Peso : 0,190 kg / 0.419 lb Tipo de Material : Plastico Longitud : 197,4 mm / 7.77 inch	33506861482, 33506869096 6861482, 6869096
	<b>BW5087</b> Horquilla & Tijera	Peso : 2,280 kg / 5.027 lb Tipo de Material : Aluminio	31106861162, 6861162
	<b>BW5088</b> Horquilla & Tijera	Peso : 2,280 kg / 5.027 lb Tipo de Material : Aluminio	31106861161, 6861161
	<b>BW6037</b> Horquilla & Tijera	Peso : 1,308 kg / 2.884 lb Tipo de Material : Aluminio	31106861185, 31126866240 40550, 6866240

**6 SERIES**
**G32**
**2018 -**







Imagen	Clave del Producto y Descripción	Detalles	OEM
	<b>BW2041</b> Terminal Exterior	Peso : 0,769 kg / 1.695 lb	32106868687, 32106869538 32106881535
	<b>BW2042</b> Terminal Exterior	Peso : 0,769 kg / 1.695 lb	32106868685, 32106869536 32106881534
	<b>BW3012</b> Terminal interior	Peso : 0,500 kg / 1.102 lb	32106868688*, 32106868689* 32106869535*, 32106869537* 6868688*, 6868689* 6869535*, 6869537*
	<b>BW20413012</b> Terminales Completas	Peso : 1,269 kg / 2.798 lb Terminal Exterior : BW2041 Terminal Interior : BW3012	32106868689, 6868689
	<b>BW20423012</b> Terminales Completas	Peso : 1,269 kg / 2.798 lb Terminal Exterior : BW2042 Terminal Interior : BW3012	32106868688, 6868688

\* Nombres de los vehículos, marcas, modelos, símbolos y logos, número OE y otros números de terceros en el sitio web y catálogo solo son con fines de referencia.

**6 SERIES**
**G32**
**2018 -**

Imagen	Clave del Producto y Descripción	Detalles	OEM
	<b>BW4070</b> Tornillo Estabilizador	Peso : 0,335 kg / 0.739 lb Longitud : 179 mm / 7.05 inch Nota : xdrive	31306861485, 6861485
	<b>BW4071</b> Tornillo Estabilizador	Peso : 0,190 kg / 0.419 lb Tipo de Material : Plastico Longitud : 197,4 mm / 7.77 inch	33506861482, 33506869096 6861482, 6869096
	<b>BW6037</b> Horquilla & Tijera	Peso : 1,308 kg / 2.884 lb Tipo de Material : Aluminio	31106861185, 31126866240 40550, 6866240

**7 SERIES**
**G11, G12**
**2017 -**







Imagen	Clave del Producto y Descripción	Detalles	OEM
	<b>BW2041</b> Terminal Exterior	Peso : 0,769 kg / 1.695 lb	32106868687, 32106869538 32106881535
	<b>BW2042</b> Terminal Exterior	Peso : 0,769 kg / 1.695 lb	32106868685, 32106869536 32106881534
	<b>BW3012</b> Terminal interior	Peso : 0,500 kg / 1.102 lb	32106868688*, 32106868689* 32106869535*, 32106869537* 6868688*, 6868689* 6869535*, 6869537*
	<b>BW20413012</b> Terminales Completas	Peso : 1,269 kg / 2.798 lb Terminal Exterior : BW2041 Terminal Interior : BW3012	32106868689, 6868689
	<b>BW20423012</b> Terminales Completas	Peso : 1,269 kg / 2.798 lb Terminal Exterior : BW2042 Terminal Interior : BW3012	32106868688, 6868688
	<b>BW4069</b> Tornillo Estabilizador	Peso : 0,362 kg / 0.798 lb Longitud : 242 mm / 9.53 inch Nota : RWD	31306861483
	<b>BW4070</b> Tornillo Estabilizador	Peso : 0,335 kg / 0.739 lb Longitud : 179 mm / 7.05 inch Nota : xdrive	31306861485, 6861485

\* Nombres de los vehículos, marcas, modelos, símbolos y logos, número OE y otros números de terceros en el sitio web y catálogo solo son con fines de referencia.

**7 SERIES**
**G11, G12**
**2017 -**

Imagen	Clave del Producto y Descripción	Detalles	OEM
	<b>BW4071</b> Tornillo Estabilizador	Peso : 0,190 kg / 0.419 lb Tipo de Material : Plastico Longitud : 197,4 mm / 7.77 inch	33506861482, 33506869096 6861482, 6869096

**8 SERIES**
**G14, G15, G16**
**2018 -**

Imagen	Clave del Producto y Descripción	Detalles	OEM
	<b>BW2041</b> Terminal Exterior	Peso : 0,769 kg / 1.695 lb	32106868687, 32106869538 32106881535
	<b>BW2042</b> Terminal Exterior	Peso : 0,769 kg / 1.695 lb	32106868685, 32106869536 32106881534
	<b>BW3012</b> Terminal interior	Peso : 0,500 kg / 1.102 lb	32106868688*, 32106868689* 32106869535*, 32106869537* 6868688*, 6868689* 6869535*, 6869537*
	<b>BW20413012</b> Terminales Completas	Peso : 1,269 kg / 2.798 lb Terminal Exterior : BW2041 Terminal Interior : BW3012	32106868689, 6868689
	<b>BW20423012</b> Terminales Completas	Peso : 1,269 kg / 2.798 lb Terminal Exterior : BW2042 Terminal Interior : BW3012	32106868688, 6868688
	<b>BW4070</b> Tornillo Estabilizador	Peso : 0,335 kg / 0.739 lb Longitud : 179 mm / 7.05 inch Nota : xdrive	31306861485, 6861485
	<b>BW4071</b> Tornillo Estabilizador	Peso : 0,190 kg / 0.419 lb Tipo de Material : Plastico Longitud : 197,4 mm / 7.77 inch	33506861482, 33506869096 6861482, 6869096







**i8**
**I12, I15**
**2014 - 2020**

Imagen	Clave del Producto y Descripción	Detalles	OEM
	<b>BW20403010</b> TERMINALES COMPLETAS DELANTERO	Peso : 1,160 kg / 2.557 lb Terminal Exterior : BW2040 Terminal Interior : BW3010	32106858672

\* Nombres de los vehículos, marcas, modelos, símbolos y logos, número OE y otros números de terceros en el sitio web y catálogo solo son con fines de referencia.



**M8 G14, G15 2018 -**

Imagen	Clave del Producto y Descripción	Detalles	OEM
	<b>BW2041</b> Terminal Exterior	Peso : 0,769 kg / 1.695 lb	32106868687, 32106869538 32106881535
	<b>BW2042</b> Terminal Exterior	Peso : 0,769 kg / 1.695 lb	32106868685, 32106869536 32106881534
	<b>BW3012</b> Terminal interior	Peso : 0,500 kg / 1.102 lb	32106868688*, 32106868689* 32106869535*, 32106869537* 6868688*, 6868689* 6869535*, 6869537*
	<b>BW20413012</b> Terminales Completas	Peso : 1,269 kg / 2.798 lb Terminal Exterior : BW2041 Terminal Interior : BW3012	32106868689, 6868689
	<b>BW20423012</b> Terminales Completas	Peso : 1,269 kg / 2.798 lb Terminal Exterior : BW2042 Terminal Interior : BW3012	32106868688, 6868688
	<b>BW4070</b> Tornillo Estabilizador	Peso : 0,335 kg / 0.739 lb Longitud : 179 mm / 7.05 inch Nota : xdrive	31306861485, 6861485
	<b>BW4071</b> Tornillo Estabilizador	Peso : 0,190 kg / 0.419 lb Tipo de Material : Plastico Longitud : 197,4 mm / 7.77 inch	33506861482, 33506869096 6861482, 6869096

**X3 F25 2010 - 2016**

Imagen	Clave del Producto y Descripción	Detalles	OEM
	<b>BW11073</b> Buje De Horquilla & Tijera	Chasis (Delantero / Trasero) : Trasera Posicion : Ön Alt Arka Peso : 0,110 kg / 0.243 lb	33306786980, 33326786978 6786978, 6786980

**X4 F26 2014 - 2018**

Imagen	Clave del Producto y Descripción	Detalles	OEM
	<b>BW11073</b> Buje De Horquilla & Tijera	Chasis (Delantero / Trasero) : Trasera Posicion : Ön Alt Arka Peso : 0,110 kg / 0.243 lb	33306786980, 33326786978 6786978, 6786980

\* Nombres de los vehículos, marcas, modelos, símbolos y logos, número OE y otros números de terceros en el sitio web y catálogo solo son con fines de referencia.

**BW8009 / Kit De Suspension Y Direccion**







**Z3**

**COUPE E36**

**1997 - 2003**



**Piezas del Kit**

Imagen	RIWCodigo / Nombre	OEM	OEM	RIWCodigo / Nombre	Imagen
	<b>BW11025</b> Bujes Derecha	31121136532	21121136531, 31121136531	<b>BW11026</b> Bujes Izquierdo	
	<b>BW20073817</b> Terminales Completas Frontal Derecho	32111139316	32111139315	<b>BW20083817</b> Terminales Completas Frontal Izquierdo	
	<b>BW4005</b> Tornillo Estabilizador Delantero	31351091764, 31351127689 31351128737	31121094276, 31121136530 31121140400, 31121140958 31126758514, 31126758516	<b>BW6003</b> Horquillas Frontal Derecho Inferior	
	<b>BW6004</b> Horquillas Frontal Inferior Izquierdo	31121094275, 31121136529 31121140399, 31121140957 31126758513, 31126758515			

\* Nombres de los vehiculos, marcas, modelos, simbolos y logos, numero OE y otros numeros de terceros en el sitio web y catalogo solo son con fines de referencia.

**Z3** **COUPE E36** **1997 - 2003**

Imagen	Clave del Producto y Descripción	Detalles	OEM
	<b>BW11802</b> BUJES	Posicion : Izquierda Y Derecha Peso : 1,390 kg / 3.064 lb Nota : KIT = BW11025 and BW11026	21121136531, 31121136532

**BW8009 / Kit De Suspension Y Direccion**







**Z3**

**ROADSTER E36**

**1995 - 2003**



**Piezas del Kit**

Imagen	RIWCodigo / Nombre	OEM	OEM	RIWCodigo / Nombre	Imagen
	<b>BW11025</b> Bujes Derecha	31121136532	21121136531, 31121136531	<b>BW11026</b> Bujes Izquierdo	
	<b>BW20073817</b> Terminales Completas Frontal Derecho	32111139316	32111139315	<b>BW20083817</b> Terminales Completas Frontal Izquierdo	
	<b>BW4005</b> Tornillo Estabilizador Delantero	31351091764, 31351127689 31351128737	31121094276, 31121136530 31121140400, 31121140958 31126758514, 31126758516	<b>BW6003</b> Horquillas Frontal Derecho Inferior	
	<b>BW6004</b> Horquillas Frontal Inferior Izquierdo	31121094275, 31121136529 31121140399, 31121140957 31126758513, 31126758515			

\* Nombres de los vehiculos, marcas, modelos, simbolos y logos, numero OE y otros numeros de terceros en el sitio web y catalogo solo son con fines de referencia.

**Z3****ROADSTER E36****1995 - 2003**

Imagen	Clave del Producto y Descripción	Detalles	OEM
	<b>BW11802</b> BUJES	Posicion : Izquierda Y Derecha Peso : 1,390 kg / 3.064 lb Nota : KIT = BW11025 and BW11026	21121136531, 31121136532

**BW8010 / Kit De Suspension Y Direccion**





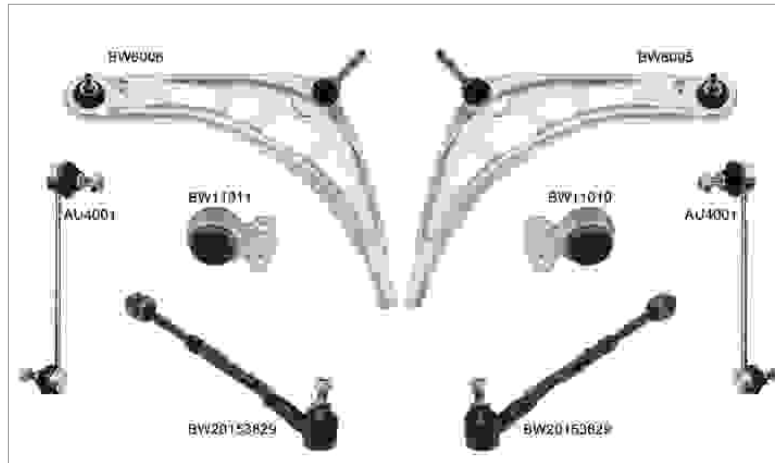

**Z4**

**COUPE E86**

**2006 - 2009**



**Piezas del Kit**

Imagen	RIWCodigo / Nombre	OEM	OEM	RIWCodigo / Nombre	Imagen
	<b>AU4001</b> Tornillo Estabilizador Delantero	893407465, 893407465A 8A0407465, 8A0407465B 8A0407465C	31126756064, 31126757623	<b>BW11010</b> Bujes Derecha	
	<b>BW11011</b> Bujes Izquierdo	31126756063, 31126757623	32106777504, 32211095956 32211096898	<b>BW20153829</b> Terminales Completas Frontal Derecho	
	<b>BW20163829</b> Terminales Completas Frontal Izquierdo	32106777503, 32211095955 32211096897	31121094466, 31126751318 31126752318, 31126752718 31126758520	<b>BW6005</b> Horquillas Frontal Derecho Inferior	
	<b>BW6006</b> Horquillas Frontal Inferior Izquierdo	31121094465, 31121096985 31122343353, 31122343359 31126750223, 31126751317 31126752717, 31126758519 31126770247, 31126774819			

\* Nombres de los vehiculos, marcas, modelos, simbolos y logos, numero OE y otros numeros de terceros en el sitio web y catalogo solo son con fines de referencia.

**BW8010 / Kit De Suspension Y Direccion**





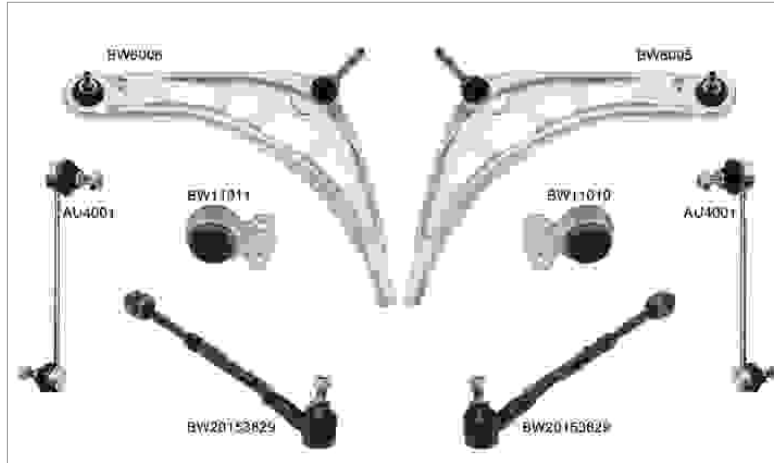

**Z4**

**ROADSTER E85**

**2003 - 2009**



**Piezas del Kit**

Imagen	RIWCodigo / Nombre	OEM	OEM	RIWCodigo / Nombre	Imagen
	<b>AU4001</b> Tornillo Estabilizador Delantero	893407465, 893407465A 8A0407465, 8A0407465B 8A0407465C	31126756064, 31126757623	<b>BW11010</b> Bujes Derecha	
	<b>BW11011</b> Bujes Izquierdo	31126756063, 31126757623	32106777504, 32211095956 32211096898	<b>BW20153829</b> Terminales Completas Frontal Derecho	
	<b>BW20163829</b> Terminales Completas Frontal Izquierdo	32106777503, 32211095955 32211096897	31121094466, 31126751318 31126752318, 31126752718 31126758520	<b>BW6005</b> Horquillas Frontal Derecho Inferior	
	<b>BW6006</b> Horquillas Frontal Inferior Izquierdo	31121094465, 31121096985 31122343353, 31122343359 31126750223, 31126751317 31126752717, 31126758519 31126770247, 31126774819			

\* Nombres de los vehiculos, marcas, modelos, simbolos y logos, numero OE y otros numeros de terceros en el sitio web y catalogo solo son con fines de referencia.

**Z8 ROADSTER E52 2000 - 2003**

Imagen	Clave del Producto y Descripción	Detalles	OEM
	<b>BW11019K</b> Buje De Horquilla & Tijera	Posicion : Peso : 0,25 kg / 0.551 lb Nota : 2 Pieces	23300200501, 23309200501 31121092010, 31129068753



**RIW<sup>®</sup>**

**BUICK**

**ALLURE I 2005 - 2009**

Imagen	Clave del Producto y Descripción	Detalles	OEM
	<b>CV3030</b> Terminal interior	Peso : 0,647 kg / 1.426 lb Longitud : 324,5 mm / 12.78 inch	26003751, 26003759 26012282, 26021769

**APOLLO II 1975 - 1975**

Imagen	Clave del Producto y Descripción	Detalles	OEM
	<b>CD4004</b> Tornillo Estabilizador	Peso : 0,264 kg / 0.582 lb Longitud : 184 mm / 7.24 inch	10023178, 10164176 C1VY5A484A

**CASCADA 2016 - 2019**

Imagen	Clave del Producto y Descripción	Detalles	OEM
	<b>VX12037</b> Soporte De Motor	Chasis (Delantero / Trasero) : Delantero Peso : 1,905 kg / 4.200 lb Nota : HYDRAULIC	13248548, 682073

**CENTURION I 1971 - 1973**

Imagen	Clave del Producto y Descripción	Detalles	OEM
	<b>CV1034</b> RÓTULA FRONTAL INFERIOR	Peso : 0,913 kg / 2.013 lb	7808865, 7814131 88965475, 9754378 9761498, 9766421
	<b>CD4004</b> Tornillo Estabilizador	Peso : 0,264 kg / 0.582 lb Longitud : 184 mm / 7.24 inch	10023178, 10164176 C1VY5A484A

**CENTURY IX 1997 - 2005**

Imagen	Clave del Producto y Descripción	Detalles	OEM
	<b>CV3030</b> Terminal interior	Peso : 0,647 kg / 1.426 lb Longitud : 324,5 mm / 12.78 inch	26003751, 26003759 26012282, 26021769

**CENTURY V 1956 - 1958**

Imagen	Clave del Producto y Descripción	Detalles	OEM
	<b>CV4056</b> Tornillo Estabilizador	Peso : 0,182 kg / 0.401 lb Longitud : 195,5 mm / 7.70 inch	25784241

**CENTURY VI 1973 - 1977**

Imagen	Clave del Producto y Descripción	Detalles	OEM
	<b>CD4004</b> Tornillo Estabilizador	Peso : 0,264 kg / 0.582 lb Longitud : 184 mm / 7.24 inch	10023178, 10164176 C1VY5A484A

**ELECTRA I 1959 - 1960**

Imagen	Clave del Producto y Descripción	Detalles	OEM
	<b>CV4056</b> Tornillo Estabilizador	Peso : 0,182 kg / 0.401 lb Longitud : 195,5 mm / 7.70 inch	25784241

**ELECTRA IV 1971 - 1976**

Imagen	Clave del Producto y Descripción	Detalles	OEM
	<b>CV1034</b> RÓTULA FRONTAL INFERIOR	Peso : 0,913 kg / 2.013 lb	7808865, 7814131 88965475, 9754378 9761498, 9766421
	<b>CD4004</b> Tornillo Estabilizador	Peso : 0,264 kg / 0.582 lb Longitud : 184 mm / 7.24 inch	10023178, 10164176 C1VY5A484A

**ELECTRA V 1977 - 1984**

Imagen	Clave del Producto y Descripción	Detalles	OEM
	<b>CD4004</b> Tornillo Estabilizador	Peso : 0,264 kg / 0.582 lb Longitud : 184 mm / 7.24 inch	10023178, 10164176 C1VY5A484A

**ELECTRA VI 1985 - 1990**

Imagen	Clave del Producto y Descripción	Detalles	OEM
	<b>CD4004</b> Tornillo Estabilizador	Peso : 0,264 kg / 0.582 lb Longitud : 184 mm / 7.24 inch	10023178, 10164176 C1VY5A484A
	<b>CD4005</b> Tornillo Estabilizador	Peso : 0,220 kg / 0.485 lb Longitud : 145 mm / 5.71 inch	25679063, 3879218

**ENCLAVE II 2018 -**

Imagen	Clave del Producto y Descripción	Detalles	OEM
	<b>BU2002</b> Terminal Exterior	Peso : 0,826 kg / 1.821 lb	23214216
	<b>BU2003</b> Terminal Exterior	Peso : 0,826 kg / 1.821 lb	23214215

**INVICTA I 1959 - 1960**

Imagen	Clave del Producto y Descripción	Detalles	OEM
	<b>CV4056</b> Tornillo Estabilizador	Peso : 0,182 kg / 0.401 lb Longitud : 195,5 mm / 7.70 inch	25784241

**LACROSSE I 2005 - 2009**







Imagen	Clave del Producto y Descripción	Detalles	OEM
	<b>CV3030</b> Terminal interior	Peso : 0,647 kg / 1.426 lb Longitud : 324,5 mm / 12.78 inch	26003751, 26003759 26012282, 26021769

**LACROSSE III 2017 -**

Imagen	Clave del Producto y Descripción	Detalles	OEM
	<b>OP2051</b> TERMINAL EXTERIOR FRONTAL DERECHO	Peso : 0,828 kg / 1.825 lb Longitud : 112 mm / 4.41 inch	23449523

\* Nombres de los vehículos, marcas, modelos, símbolos y logos, número OE y otros números de terceros en el sitio web y catálogo solo son con fines de referencia.

**LACROSSE**
**III**
**2017 -**

Imagen	Clave del Producto y Descripción	Detalles	OEM
	<b>OP2052</b> TERMINAL EXTERIOR FRONTAL IZQUIERDO	Peso : 0,828 kg / 1.825 lb Longitud : 112 mm / 4.41 inch	23449522
	<b>OP3034</b> Terminal interior	Peso : 0,564 kg / 1.243 lb Longitud : 244 mm / 9.61 inch Tamaño de la Rosca : M16X1,5 Diámetro de Cuerda del Perno : M14X1,5	23449526
	<b>OP4031</b> Tornillo Estabilizador	Peso : 0,394 kg / 0.869 lb Tipo de Material : Metal Longitud : 274 mm / 10.79 inch	23322794, 84077103
	<b>OP4032</b> Tornillo Estabilizador	Peso : 0,394 kg / 0.869 lb Tipo de Material : Metal Longitud : 274 mm / 10.79 inch	23322795, 84077102
	<b>OP11057</b> Buje De Horquilla & Tijera	Chasis (Delantero / Trasero) : Delantero Posicion : Inferior Grande Peso : 0.69 kg / 1.521 lb	23167662*, 84198829* 84198832*, 84198833*
	<b>OP11058</b> Buje De Horquilla & Tijera	Chasis (Delantero / Trasero) : Delantero Posicion : Inferior Chico Peso : 0.54 kg / 1.190 lb	23167662*, 84198829* 84198832*, 84198833*

**LESABRE**
**I**
**1959 - 1960**

Imagen	Clave del Producto y Descripción	Detalles	OEM
	<b>CV4056</b> Tornillo Estabilizador	Peso : 0,182 kg / 0.401 lb Longitud : 195,5 mm / 7.70 inch	25784241

**LESABRE**
**IV**
**1971 - 1976**

Imagen	Clave del Producto y Descripción	Detalles	OEM
	<b>CV1034</b> RÓTULA FRONTAL INFERIOR	Peso : 0,913 kg / 2.013 lb	7808865, 7814131 88965475, 9754378 9761498, 9766421
	<b>CD4004</b> Tornillo Estabilizador	Peso : 0,264 kg / 0.582 lb Longitud : 184 mm / 7.24 inch	10023178, 10164176 C1VY5A484A

\* Nombres de los vehículos, marcas, modelos, símbolos y logos, número OE y otros números de terceros en el sitio web y catálogo solo son con fines de referencia.

**LESABRE V 1977 - 1985**

Imagen	Clave del Producto y Descripción	Detalles	OEM
	<b>CD4004</b> Tornillo Estabilizador	Peso : 0,264 kg / 0.582 lb Longitud : 184 mm / 7.24 inch	10023178, 10164176 C1VY5A484A

**LESABRE VI 1986 - 1991**

Imagen	Clave del Producto y Descripción	Detalles	OEM
	<b>CD4004</b> Tornillo Estabilizador	Peso : 0,264 kg / 0.582 lb Longitud : 184 mm / 7.24 inch	10023178, 10164176 C1VY5A484A

**LESABRE VII 1992 - 1999**

Imagen	Clave del Producto y Descripción	Detalles	OEM
	<b>CD4005</b> Tornillo Estabilizador	Peso : 0,220 kg / 0.485 lb Longitud : 145 mm / 5.71 inch	25679063, 3879218

**LESABRE VIII 2000 - 2005**

Imagen	Clave del Producto y Descripción	Detalles	OEM
	<b>CV3030</b> Terminal interior	Peso : 0,647 kg / 1.426 lb Longitud : 324,5 mm / 12.78 inch	26003751, 26003759 26012282, 26021769
	<b>CD4005</b> Tornillo Estabilizador	Peso : 0,220 kg / 0.485 lb Longitud : 145 mm / 5.71 inch	25679063, 3879218

**LUCERNE 2006 - 2011**

Imagen	Clave del Producto y Descripción	Detalles	OEM
	<b>CD4005</b> Tornillo Estabilizador	Peso : 0,220 kg / 0.485 lb Longitud : 145 mm / 5.71 inch	25679063, 3879218

**PARK AVENUE I 1991 - 1996**

Imagen	Clave del Producto y Descripción	Detalles	OEM
	<b>CD4005</b> Tornillo Estabilizador	Peso : 0,220 kg / 0.485 lb Longitud : 145 mm / 5.71 inch	25679063, 3879218

**PARK AVENUE II 1997 - 2005**

Imagen	Clave del Producto y Descripción	Detalles	OEM
	<b>CV3030</b> Terminal interior	Peso : 0,647 kg / 1.426 lb Longitud : 324,5 mm / 12.78 inch	26003751, 26003759 26012282, 26021769
	<b>CD4005</b> Tornillo Estabilizador	Peso : 0,220 kg / 0.485 lb Longitud : 145 mm / 5.71 inch	25679063, 3879218

**RAINIER 2003 - 2007**

Imagen	Clave del Producto y Descripción	Detalles	OEM
	<b>CV3035</b> Terminal interior	Peso : 0,534 kg / 1.177 lb Longitud : 135 mm / 5.31 inch	26100288, 8261002880

**REGAL I 1973 - 1977**

Imagen	Clave del Producto y Descripción	Detalles	OEM
	<b>CD4004</b> Tornillo Estabilizador	Peso : 0,264 kg / 0.582 lb Longitud : 184 mm / 7.24 inch	10023178, 10164176 C1VY5A484A

**REGAL III 1988 - 1996**

Imagen	Clave del Producto y Descripción	Detalles	OEM
	<b>CV3030</b> Terminal interior	Peso : 0,647 kg / 1.426 lb Longitud : 324,5 mm / 12.78 inch	26003751, 26003759 26012282, 26021769

**REGAL IV 1997 - 2004**

Imagen	Clave del Producto y Descripción	Detalles	OEM
	<b>CV3030</b> Terminal interior	Peso : 0,647 kg / 1.426 lb Longitud : 324,5 mm / 12.78 inch	26003751, 26003759 26012282, 26021769

**REGAL V 2011 - 2016**

Imagen	Clave del Producto y Descripción	Detalles	OEM
	<b>VX12028</b> Soporte De Motor	Chasis (Delantero / Trasero) : Delantero Peso : 0,830 kg / 1.830 lb	13227769, 684616

**REGAL VI 2017 -**

Imagen	Clave del Producto y Descripción	Detalles	OEM
	<b>OP3034</b> Terminal interior	Peso : 0,564 kg / 1.243 lb Longitud : 244 mm / 9.61 inch Tamaño de la Rosca : M16X1,5 Diámetro de Cuerda del Perno : M14X1,5	23449526

**RIVIERA III 1971 - 1973**

Imagen	Clave del Producto y Descripción	Detalles	OEM
	<b>CV1034</b> RÓTULA FRONTAL INFERIOR	Peso : 0,913 kg / 2.013 lb	7808865, 7814131 88965475, 9754378 9761498, 9766421

**RIVIERA IV 1974 - 1976**

Imagen	Clave del Producto y Descripción	Detalles	OEM
	<b>CV1034</b> RÓTULA FRONTAL INFERIOR	Peso : 0,913 kg / 2.013 lb	7808865, 7814131 88965475, 9754378 9761498, 9766421
	<b>CD4004</b> Tornillo Estabilizador	Peso : 0,264 kg / 0.582 lb Longitud : 184 mm / 7.24 inch	10023178, 10164176 C1VY5A484A



**RIVIERA VIII 1995 - 1999**

Imagen	Clave del Producto y Descripción	Detalles	OEM
	<b>CV3030</b> Terminal interior	Peso : 0,647 kg / 1.426 lb Longitud : 324,5 mm / 12.78 inch	26003751, 26003759 26012282, 26021769
	<b>CD4005</b> Tornillo Estabilizador	Peso : 0,220 kg / 0.485 lb Longitud : 145 mm / 5.71 inch	25679063, 3879218

**ROADMASTER VII 1957 - 1957**

Imagen	Clave del Producto y Descripción	Detalles	OEM
	<b>CV4056</b> Tornillo Estabilizador	Peso : 0,182 kg / 0.401 lb Longitud : 195,5 mm / 7.70 inch	25784241

**ROADMASTER VIII 1991 - 1996**

Imagen	Clave del Producto y Descripción	Detalles	OEM
	<b>CD4004</b> Tornillo Estabilizador	Peso : 0,264 kg / 0.582 lb Longitud : 184 mm / 7.24 inch	10023178, 10164176 C1VY5A484A

**SKYHAWK I 1975 - 1976**

Imagen	Clave del Producto y Descripción	Detalles	OEM
	<b>CD4004</b> Tornillo Estabilizador	Peso : 0,264 kg / 0.582 lb Longitud : 184 mm / 7.24 inch	10023178, 10164176 C1VY5A484A

**SKYHAWK I 1ST FACELIFT 1977 - 1978**

Imagen	Clave del Producto y Descripción	Detalles	OEM
	<b>CD4004</b> Tornillo Estabilizador	Peso : 0,264 kg / 0.582 lb Longitud : 184 mm / 7.24 inch	10023178, 10164176 C1VY5A484A

**SKYHAWK I 2ND FACELIFT 1979 - 1980**

Imagen	Clave del Producto y Descripción	Detalles	OEM
	<b>CD4004</b> Tornillo Estabilizador	Peso : 0,264 kg / 0.582 lb Longitud : 184 mm / 7.24 inch	10023178, 10164176 C1VY5A484A

**SKYHAWK II 1982 - 1986**

Imagen	Clave del Producto y Descripción	Detalles	OEM
	<b>CD4004</b> Tornillo Estabilizador	Peso : 0,264 kg / 0.582 lb Longitud : 184 mm / 7.24 inch	10023178, 10164176 C1VY5A484A

**SKYHAWK II FACELIFT 1987 - 1989**

Imagen	Clave del Producto y Descripción	Detalles	OEM
	<b>CD4004</b> Tornillo Estabilizador	Peso : 0,264 kg / 0.582 lb Longitud : 184 mm / 7.24 inch	10023178, 10164176 C1VY5A484A

**SKYLARK I 1964 - 1967**

Imagen	Clave del Producto y Descripción	Detalles	OEM
	<b>CV4056</b> Tornillo Estabilizador	Peso : 0,182 kg / 0.401 lb Longitud : 195,5 mm / 7.70 inch	25784241

**SKYLARK II 1968 - 1972**

Imagen	Clave del Producto y Descripción	Detalles	OEM
	<b>CV4056</b> Tornillo Estabilizador	Peso : 0,182 kg / 0.401 lb Longitud : 195,5 mm / 7.70 inch	25784241

**SKYLARK III 1975 - 1979**

Imagen	Clave del Producto y Descripción	Detalles	OEM
	<b>CD4004</b> Tornillo Estabilizador	Peso : 0,264 kg / 0.582 lb Longitud : 184 mm / 7.24 inch	10023178, 10164176 C1VY5A484A

\* Nombres de los vehículos, marcas, modelos, símbolos y logos, número OE y otros números de terceros en el sitio web y catálogo solo son con fines de referencia.

**SKYLARK IV 1980 - 1985**

Imagen	Clave del Producto y Descripción	Detalles	OEM
	<b>CD4004</b> Tornillo Estabilizador	Peso : 0,264 kg / 0.582 lb Longitud : 184 mm / 7.24 inch	10023178, 10164176 C1VY5A484A

**SKYLARK V 1986 - 1991**

Imagen	Clave del Producto y Descripción	Detalles	OEM
	<b>CD4004</b> Tornillo Estabilizador	Peso : 0,264 kg / 0.582 lb Longitud : 184 mm / 7.24 inch	10023178, 10164176 C1VY5A484A

**SPECIAL 1957 - 1958**

Imagen	Clave del Producto y Descripción	Detalles	OEM
	<b>CV4056</b> Tornillo Estabilizador	Peso : 0,182 kg / 0.401 lb Longitud : 195,5 mm / 7.70 inch	25784241

**SUPER V 1957 - 1958**

Imagen	Clave del Producto y Descripción	Detalles	OEM
	<b>CV4056</b> Tornillo Estabilizador	Peso : 0,182 kg / 0.401 lb Longitud : 195,5 mm / 7.70 inch	25784241

**VERANO I 2012 - 2016**

Imagen	Clave del Producto y Descripción	Detalles	OEM
	<b>VX12037</b> Soporte De Motor	Chasis (Delantero / Trasero) : Delantero Peso : 1,905 kg / 4.200 lb Nota : HYDRAULIC	13248548, 682073

**RIW<sup>®</sup>**

**CADILLAC**

**ALLANTE**
**1987 - 1989**

Imagen	Clave del Producto y Descripción	Detalles	OEM
	<b>CD4005</b> Tornillo Estabilizador	Peso : 0,220 kg / 0.485 lb Longitud : 145 mm / 5.71 inch	25679063, 3879218

**ATS**
**2013 - 2019**

Imagen	Clave del Producto y Descripción	Detalles	OEM
	<b>CV2057</b> Terminal Exterior	Peso : 0,828 kg / 1.825 lb Longitud : 155 mm / 6.10 inch	22961954
	<b>CV2058</b> Terminal Exterior	Peso : 0,828 kg / 1.825 lb Longitud : 155 mm / 6.10 inch	22961953

**BROUGHAM**
**1987 - 1992**

Imagen	Clave del Producto y Descripción	Detalles	OEM
	<b>CV1034</b> RÓTULA FRONTAL INFERIOR	Peso : 0,913 kg / 2.013 lb	7808865, 7814131 88965475, 9754378 9761498, 9766421
	<b>CD4004</b> Tornillo Estabilizador	Peso : 0,264 kg / 0.582 lb Longitud : 184 mm / 7.24 inch	10023178, 10164176 C1VY5A484A

**CALAIS I**
**1965 - 1970**

Imagen	Clave del Producto y Descripción	Detalles	OEM
	<b>CV4056</b> Tornillo Estabilizador	Peso : 0,182 kg / 0.401 lb Longitud : 195,5 mm / 7.70 inch	25784241

**CALAIS II**
**1971 - 1976**

Imagen	Clave del Producto y Descripción	Detalles	OEM
	<b>CV4056</b> Tornillo Estabilizador	Peso : 0,182 kg / 0.401 lb Longitud : 195,5 mm / 7.70 inch	25784241

\* Nombres de los vehículos, marcas, modelos, símbolos y logos, número OE y otros números de terceros en el sitio web y catálogo solo son con fines de referencia.





**CIMARRON**
**1982 - 1988**

Imagen	Clave del Producto y Descripción	Detalles	OEM
	<b>CD4004</b> Tornillo Estabilizador	Peso : 0,264 kg / 0.582 lb Longitud : 184 mm / 7.24 inch	10023178, 10164176 C1VY5A484A

**CT6**
**2016 -**

Imagen	Clave del Producto y Descripción	Detalles	OEM
	<b>CD2007</b> Terminal Exterior	Peso : 1,051 kg / 2.317 lb Longitud : 192 mm / 7.56 inch	23183693
	<b>CD2008</b> Terminal Exterior	Peso : 1,051 kg / 2.317 lb Longitud : 192 mm / 7.56 inch	23183691

**CTS**
**I**
**2003 - 2007**

Imagen	Clave del Producto y Descripción	Detalles	OEM
	<b>CD2001</b> Terminal Exterior	Peso : 0,721 kg / 1.590 lb Longitud : 170 mm / 6.69 inch	19167230, 88892774
	<b>CD2002</b> Terminal Exterior	Peso : 0,721 kg / 1.590 lb Longitud : 170 mm / 6.69 inch	19167231, 88892773
	<b>CD4006</b> Tornillo Estabilizador	Peso : 0,223 kg / 0.492 lb Tipo de Material : Metal Longitud : 82 mm / 3.23 inch	15858712, 25740519
	<b>CD4007</b> Tornillo Estabilizador	Peso : 0,223 kg / 0.492 lb Tipo de Material : Metal Longitud : 82 mm / 3.23 inch	15858711, 25740518

**CTS**
**II**
**2008 - 2013**

Imagen	Clave del Producto y Descripción	Detalles	OEM
	<b>CD2003</b> Terminal Exterior	Peso : 0,685 kg / 1.510 lb Longitud : 170,5 mm / 6.71 inch	19177443

\* Nombres de los vehículos, marcas, modelos, símbolos y logos, número OE y otros números de terceros en el sitio web y catálogo solo son con fines de referencia.

**CTS II 2008 - 2013**

Imagen	Clave del Producto y Descripción	Detalles	OEM
	<b>CD2004</b> Terminal Exterior	Peso : 0,685 kg / 1.510 lb Longitud : 170,5 mm / 6.71 inch	19177442
	<b>CD2005</b> Terminal Exterior	Peso : 1,075 kg / 2.370 lb Longitud : 275 mm / 10.83 inch	19177445, 88964306
	<b>CD2006</b> Terminal Exterior	Peso : 1,075 kg / 2.370 lb Longitud : 275 mm / 10.83 inch	19177444, 89060262

**CTS III 2014 - 2019**

Imagen	Clave del Producto y Descripción	Detalles	OEM
	<b>CV2057</b> Terminal Exterior	Peso : 0,828 kg / 1.825 lb Longitud : 155 mm / 6.10 inch	22961954
	<b>CV2058</b> Terminal Exterior	Peso : 0,828 kg / 1.825 lb Longitud : 155 mm / 6.10 inch	22961953

**DE VILLE III 1965 - 1970**

Imagen	Clave del Producto y Descripción	Detalles	OEM
	<b>CV4056</b> Tornillo Estabilizador	Peso : 0,182 kg / 0.401 lb Longitud : 195,5 mm / 7.70 inch	25784241

**DE VILLE IV 1971 - 1976**

Imagen	Clave del Producto y Descripción	Detalles	OEM
	<b>CV4056</b> Tornillo Estabilizador	Peso : 0,182 kg / 0.401 lb Longitud : 195,5 mm / 7.70 inch	25784241

**DE VILLE**
**V**
**1977 - 1984**

Imagen	Clave del Producto y Descripción	Detalles	OEM
	<b>CV1034</b> RÓTULA FRONTAL INFERIOR	Peso : 0,913 kg / 2.013 lb	7808865, 7814131 88965475, 9754378 9761498, 9766421
	<b>CD4004</b> Tornillo Estabilizador	Peso : 0,264 kg / 0.582 lb Longitud : 184 mm / 7.24 inch	10023178, 10164176 C1VY5A484A

**DE VILLE**
**VII**
**1994 - 1999**

Imagen	Clave del Producto y Descripción	Detalles	OEM
	<b>CV3030</b> Terminal interior	Peso : 0,647 kg / 1.426 lb Longitud : 324,5 mm / 12.78 inch	26003751, 26003759 26012282, 26021769

**DE VILLE**
**VIII**
**2000 - 2005**

Imagen	Clave del Producto y Descripción	Detalles	OEM
	<b>CD4005</b> Tornillo Estabilizador	Peso : 0,220 kg / 0.485 lb Longitud : 145 mm / 5.71 inch	25679063, 3879218

**DTS**
**2006 - 2011**

Imagen	Clave del Producto y Descripción	Detalles	OEM
	<b>CD4005</b> Tornillo Estabilizador	Peso : 0,220 kg / 0.485 lb Longitud : 145 mm / 5.71 inch	25679063, 3879218

**ELDORADO**
**X**
**1979 - 1985**

Imagen	Clave del Producto y Descripción	Detalles	OEM
	<b>CD4005</b> Tornillo Estabilizador	Peso : 0,220 kg / 0.485 lb Longitud : 145 mm / 5.71 inch	25679063, 3879218



**ELDORADO XI 1986 - 1991**

Imagen	Clave del Producto y Descripción	Detalles	OEM
	<b>CD4005</b> Tornillo Estabilizador	Peso : 0,220 kg / 0.485 lb Longitud : 145 mm / 5.71 inch	25679063, 3879218

**ELDORADO XII 1992 - 2002**

Imagen	Clave del Producto y Descripción	Detalles	OEM
	<b>CV3030</b> Terminal interior	Peso : 0,647 kg / 1.426 lb Longitud : 324,5 mm / 12.78 inch	26003751, 26003759 26012282, 26021769

**ESCALADE I GMT400 1999 - 2001**

Imagen	Clave del Producto y Descripción	Detalles	OEM
	<b>CV1035</b> RÓTULA FRONTAL SUPERIOR	Peso : 0,668 kg / 1.473 lb	15575901, 15617715 15634385, 15634904 15659518, 15687080

**ESCALADE II GMT800 2002 - 2006**

Imagen	Clave del Producto y Descripción	Detalles	OEM
	<b>CD9001</b> Horquilla & Tijera	Peso : 3,304 kg / 7.284 lb Tipo de Material : Chapa Metálica	22868629

**ESCALADE III GMT900 2007 - 2014**

Imagen	Clave del Producto y Descripción	Detalles	OEM
	<b>CD9001</b> Horquilla & Tijera	Peso : 3,304 kg / 7.284 lb Tipo de Material : Chapa Metálica	22868629

**ESCALADE IV GMTK2XL 2015 - 2020**

Imagen	Clave del Producto y Descripción	Detalles	OEM
	<b>CD9001</b> Horquilla & Tijera	Peso : 3,304 kg / 7.284 lb Tipo de Material : Chapa Metálica	22868629

\* Nombres de los vehículos, marcas, modelos, símbolos y logos, número OE y otros números de terceros en el sitio web y catálogo solo son con fines de referencia.

**FLEETWOOD**
**V**
**1977 - 1984**

Imagen	Clave del Producto y Descripción	Detalles	OEM
	<b>CV1034</b> RÓTULA FRONTAL INFERIOR	Peso : 0,913 kg / 2.013 lb	7808865, 7814131 88965475, 9754378 9761498, 9766421
	<b>CD4004</b> Tornillo Estabilizador	Peso : 0,264 kg / 0.582 lb Longitud : 184 mm / 7.24 inch	10023178, 10164176 C1VY5A484A

**FLEETWOOD**
**VI**
**1985 - 1988**

Imagen	Clave del Producto y Descripción	Detalles	OEM
	<b>CD4004</b> Tornillo Estabilizador	Peso : 0,264 kg / 0.582 lb Longitud : 184 mm / 7.24 inch	10023178, 10164176 C1VY5A484A
	<b>CD4005</b> Tornillo Estabilizador	Peso : 0,220 kg / 0.485 lb Longitud : 145 mm / 5.71 inch	25679063, 3879218

**FLEETWOOD**
**VII**
**1989 - 1992**

Imagen	Clave del Producto y Descripción	Detalles	OEM
	<b>CD4004</b> Tornillo Estabilizador	Peso : 0,264 kg / 0.582 lb Longitud : 184 mm / 7.24 inch	10023178, 10164176 C1VY5A484A
	<b>CD4005</b> Tornillo Estabilizador	Peso : 0,220 kg / 0.485 lb Longitud : 145 mm / 5.71 inch	25679063, 3879218

**FLEETWOOD**
**VIII**
**1993 - 1996**

Imagen	Clave del Producto y Descripción	Detalles	OEM
	<b>CD4004</b> Tornillo Estabilizador	Peso : 0,264 kg / 0.582 lb Longitud : 184 mm / 7.24 inch	10023178, 10164176 C1VY5A484A





**SEVILLE IV 1992 - 1997**

Imagen	Clave del Producto y Descripción	Detalles	OEM
	<b>CV3030</b> Terminal interior	Peso : 0,647 kg / 1.426 lb Longitud : 324,5 mm / 12.78 inch	26003751, 26003759 26012282, 26021769

**SEVILLE V 1998 - 2005**

Imagen	Clave del Producto y Descripción	Detalles	OEM
	<b>CD4005</b> Tornillo Estabilizador	Peso : 0,220 kg / 0.485 lb Longitud : 145 mm / 5.71 inch	25679063, 3879218

**SRX I 2004 - 2009**





Imagen	Clave del Producto y Descripción	Detalles	OEM
	<b>CD2009</b> Terminal Exterior	Peso : 1,064 kg / 2.346 lb Longitud : 275 mm / 10.83 inch	88957172
	<b>CD2010</b> Terminal Exterior	Peso : 1,064 kg / 2.346 lb Longitud : 275 mm / 10.83 inch	88957176
	<b>CD4008</b> Tornillo Estabilizador	Peso : 0,309 kg / 0.681 lb Tipo de Material : Metal Longitud : 82 mm / 3.23 inch	15840472, 15895320 25768312
	<b>CD4009</b> Tornillo Estabilizador	Peso : 0,309 kg / 0.681 lb Tipo de Material : Metal Longitud : 82 mm / 3.23 inch	15840471, 15895319 25768311

**SRX II 2010 - 2016**

Imagen	Clave del Producto y Descripción	Detalles	OEM
	<b>CD4010</b> Tornillo Estabilizador	Peso : 0,502 kg / 1.107 lb Tipo de Material : Metal Longitud : 280 mm / 11.02 inch	15870889, 20984481
	<b>VX12028</b> Soporte De Motor	Chasis (Delantero / Trasero) : Delantero Peso : 0,830 kg / 1.830 lb	13227769, 684616

\* Nombres de los vehículos, marcas, modelos, símbolos y logos, número OE y otros números de terceros en el sitio web y catálogo solo son con fines de referencia.

**STS**
**2005 - 2011**

Imagen	Clave del Producto y Descripción	Detalles	OEM
	<b>CD2005</b> Terminal Exterior	Peso : 1,075 kg / 2.370 lb Longitud : 275 mm / 10.83 inch	19177445, 88964306
	<b>CD2006</b> Terminal Exterior	Peso : 1,075 kg / 2.370 lb Longitud : 275 mm / 10.83 inch	19177444, 89060262
	<b>CD4008</b> Tornillo Estabilizador	Peso : 0,309 kg / 0.681 lb Tipo de Material : Metal Longitud : 82 mm / 3.23 inch	15840472, 15895320 25768312
	<b>CD4009</b> Tornillo Estabilizador	Peso : 0,309 kg / 0.681 lb Tipo de Material : Metal Longitud : 82 mm / 3.23 inch	15840471, 15895319 25768311

**XLR**
**2004 - 2009**

Imagen	Clave del Producto y Descripción	Detalles	OEM
	<b>CV2231</b> TERMINAL EXTERIOR DELANTERO	Peso : 0,502 kg / 1.107 lb Longitud : 105 mm / 4.13 inch	26000001, 26071832 26086581, 7841637 7849266

**XT5**
**2017 -**

Imagen	Clave del Producto y Descripción	Detalles	OEM
	<b>BU2002</b> Terminal Exterior	Peso : 0,826 kg / 1.821 lb	23214216
	<b>BU2003</b> Terminal Exterior	Peso : 0,826 kg / 1.821 lb	23214215



**RIW<sup>®</sup>**

**CHEVROLET**

**ASTRO I 1985 - 1994**

Imagen	Clave del Producto y Descripción	Detalles	OEM
	<b>CV1034</b> RÓTULA FRONTAL INFERIOR	Peso : 0,913 kg / 2.013 lb	7808865, 7814131 88965475, 9754378 9761498, 9766421
	<b>CD4004</b> Tornillo Estabilizador	Peso : 0,264 kg / 0.582 lb Longitud : 184 mm / 7.24 inch	10023178, 10164176 C1VY5A484A

**ASTRO II 1995 - 2005**

Imagen	Clave del Producto y Descripción	Detalles	OEM
	<b>CV1034</b> RÓTULA FRONTAL INFERIOR	Peso : 0,913 kg / 2.013 lb	7808865, 7814131 88965475, 9754378 9761498, 9766421
	<b>CV1035</b> RÓTULA FRONTAL SUPERIOR	Peso : 0,668 kg / 1.473 lb	15575901, 15617715 15634385, 15634904 15659518, 15687080
	<b>CD4004</b> Tornillo Estabilizador	Peso : 0,264 kg / 0.582 lb Longitud : 184 mm / 7.24 inch	10023178, 10164176 C1VY5A484A

**AVALANCHE GMT800 2002 - 2006**

Imagen	Clave del Producto y Descripción	Detalles	OEM
	<b>CD9001</b> Horquilla & Tijera	Peso : 3,304 kg / 7.284 lb Tipo de Material : Chapa Metálica	22868629

**AVEO T300 2011 -**

Imagen	Clave del Producto y Descripción	Detalles	OEM
	<b>CV12019</b> Soporte De Motor	Chasis (Delantero / Trasero) : Delantero Posicion : Superior Izquierdo Peso : 0.715 kg / 1.576 lb	95463563

**BEL AIR IX 1971 - 1976**

Imagen	Clave del Producto y Descripción	Detalles	OEM
	<b>CV1034</b> RÓTULA FRONTAL INFERIOR	Peso : 0,913 kg / 2.013 lb	7808865, 7814131 88965475, 9754378 9761498, 9766421
	<b>CD4004</b> Tornillo Estabilizador	Peso : 0,264 kg / 0.582 lb Longitud : 184 mm / 7.24 inch	10023178, 10164176 C1VY5A484A

**BERETTA I 1987 - 1996**

Imagen	Clave del Producto y Descripción	Detalles	OEM
	<b>CD4004</b> Tornillo Estabilizador	Peso : 0,264 kg / 0.582 lb Longitud : 184 mm / 7.24 inch	10023178, 10164176 C1VY5A484A

**BISCAYNE VII 1971 - 1975**

Imagen	Clave del Producto y Descripción	Detalles	OEM
	<b>CV1034</b> RÓTULA FRONTAL INFERIOR	Peso : 0,913 kg / 2.013 lb	7808865, 7814131 88965475, 9754378 9761498, 9766421
	<b>CD4004</b> Tornillo Estabilizador	Peso : 0,264 kg / 0.582 lb Longitud : 184 mm / 7.24 inch	10023178, 10164176 C1VY5A484A

**BLAZER 1992 - 1994**

Imagen	Clave del Producto y Descripción	Detalles	OEM
	<b>CV1035</b> RÓTULA FRONTAL SUPERIOR	Peso : 0,668 kg / 1.473 lb	15575901, 15617715 15634385, 15634904 15659518, 15687080

**BLAZER 1995 - 2005**

Imagen	Clave del Producto y Descripción	Detalles	OEM
	<b>CV4055</b> Tornillo Estabilizador	Peso : 0,320 kg / 0.705 lb Longitud : 118 mm / 4.65 inch	15996064

\* Nombres de los vehículos, marcas, modelos, símbolos y logos, número OE y otros números de terceros en el sitio web y catálogo solo son con fines de referencia.

**BROOKWOOD VII 1971 - 1972**

Imagen	Clave del Producto y Descripción	Detalles	OEM
	<b>CV1034</b> RÓTULA FRONTAL INFERIOR	Peso : 0,913 kg / 2.013 lb	7808865, 7814131 88965475, 9754378 9761498, 9766421

**C1500 1995 - 1999**

Imagen	Clave del Producto y Descripción	Detalles	OEM
	<b>CV1035</b> RÓTULA FRONTAL SUPERIOR	Peso : 0,668 kg / 1.473 lb	15575901, 15617715 15634385, 15634904 15659518, 15687080
	<b>CD4004</b> Tornillo Estabilizador	Peso : 0,264 kg / 0.582 lb Longitud : 184 mm / 7.24 inch	10023178, 10164176 C1VY5A484A

**C1500 SUBURBAN 1992 - 1999**

Imagen	Clave del Producto y Descripción	Detalles	OEM
	<b>CD4004</b> Tornillo Estabilizador	Peso : 0,264 kg / 0.582 lb Longitud : 184 mm / 7.24 inch	10023178, 10164176 C1VY5A484A

**C2500 1989 - 2000**

Imagen	Clave del Producto y Descripción	Detalles	OEM
	<b>CV1035</b> RÓTULA FRONTAL SUPERIOR	Peso : 0,668 kg / 1.473 lb	15575901, 15617715 15634385, 15634904 15659518, 15687080

**C2500 PICKUP 1988 - 1999**

Imagen	Clave del Producto y Descripción	Detalles	OEM
	<b>CD4004</b> Tornillo Estabilizador	Peso : 0,264 kg / 0.582 lb Longitud : 184 mm / 7.24 inch	10023178, 10164176 C1VY5A484A



**C2500 SUBURBAN 1992 - 1999**

Imagen	Clave del Producto y Descripción	Detalles	OEM
	<b>CD4004</b> Tornillo Estabilizador	Peso : 0,264 kg / 0.582 lb Longitud : 184 mm / 7.24 inch	10023178, 10164176 C1VY5A484A

**C3500 PICKUP 1989 - 2000**

Imagen	Clave del Producto y Descripción	Detalles	OEM
	<b>CD4004</b> Tornillo Estabilizador	Peso : 0,264 kg / 0.582 lb Longitud : 184 mm / 7.24 inch	10023178, 10164176 C1VY5A484A

**CAMARO II 1970 - 1981**

Imagen	Clave del Producto y Descripción	Detalles	OEM
	<b>CD4004</b> Tornillo Estabilizador	Peso : 0,264 kg / 0.582 lb Longitud : 184 mm / 7.24 inch	10023178, 10164176 C1VY5A484A

**CAMARO III 1982 - 1993**

Imagen	Clave del Producto y Descripción	Detalles	OEM
	<b>CD4004</b> Tornillo Estabilizador	Peso : 0,264 kg / 0.582 lb Longitud : 184 mm / 7.24 inch	10023178, 10164176 C1VY5A484A

**CAMARO IV 1993 - 2002**

Imagen	Clave del Producto y Descripción	Detalles	OEM
	<b>CD4004</b> Tornillo Estabilizador	Peso : 0,264 kg / 0.582 lb Longitud : 184 mm / 7.24 inch	10023178, 10164176 C1VY5A484A

**CAMARO VI 2016 -**

Imagen	Clave del Producto y Descripción	Detalles	OEM
	<b>CV2057</b> Terminal Exterior	Peso : 0,828 kg / 1.825 lb Longitud : 155 mm / 6.10 inch	22961954

\* Nombres de los vehículos, marcas, modelos, símbolos y logos, número OE y otros números de terceros en el sitio web y catálogo solo son con fines de referencia.

**CAMARO VI 2016 -**

Imagen	Clave del Producto y Descripción	Detalles	OEM
	<b>CV2058</b> Terminal Exterior	Peso : 0,828 kg / 1.825 lb Longitud : 155 mm / 6.10 inch	22961953

**CAPRICE IV 1971 - 1976**

Imagen	Clave del Producto y Descripción	Detalles	OEM
	<b>CV1034</b> RÓTULA FRONTAL INFERIOR	Peso : 0,913 kg / 2.013 lb	7808865, 7814131 88965475, 9754378 9761498, 9766421
	<b>CD4004</b> Tornillo Estabilizador	Peso : 0,264 kg / 0.582 lb Longitud : 184 mm / 7.24 inch	10023178, 10164176 C1VY5A484A

**CAPRICE V 1977 - 1990**

Imagen	Clave del Producto y Descripción	Detalles	OEM
	<b>CV1034</b> RÓTULA FRONTAL INFERIOR	Peso : 0,913 kg / 2.013 lb	7808865, 7814131 88965475, 9754378 9761498, 9766421
	<b>CD4004</b> Tornillo Estabilizador	Peso : 0,264 kg / 0.582 lb Longitud : 184 mm / 7.24 inch	10023178, 10164176 C1VY5A484A

**CAPRICE VI 1991 - 1996**

Imagen	Clave del Producto y Descripción	Detalles	OEM
	<b>CV1034</b> RÓTULA FRONTAL INFERIOR	Peso : 0,913 kg / 2.013 lb	7808865, 7814131 88965475, 9754378 9761498, 9766421
	<b>CD4004</b> Tornillo Estabilizador	Peso : 0,264 kg / 0.582 lb Longitud : 184 mm / 7.24 inch	10023178, 10164176 C1VY5A484A

**CAVALIER I 1982 - 1987**

Imagen	Clave del Producto y Descripción	Detalles	OEM
	<b>CD4004</b> Tornillo Estabilizador	Peso : 0,264 kg / 0.582 lb Longitud : 184 mm / 7.24 inch	10023178, 10164176 C1VY5A484A

**CAVALIER II 1988 - 1994**

Imagen	Clave del Producto y Descripción	Detalles	OEM
	<b>CD4004</b> Tornillo Estabilizador	Peso : 0,264 kg / 0.582 lb Longitud : 184 mm / 7.24 inch	10023178, 10164176 C1VY5A484A

**CHEVELLE I 1964 - 1967**

Imagen	Clave del Producto y Descripción	Detalles	OEM
	<b>CV4056</b> Tornillo Estabilizador	Peso : 0,182 kg / 0.401 lb Longitud : 195,5 mm / 7.70 inch	25784241

**CHEVELLE II 1968 - 1972**

Imagen	Clave del Producto y Descripción	Detalles	OEM
	<b>CV4056</b> Tornillo Estabilizador	Peso : 0,182 kg / 0.401 lb Longitud : 195,5 mm / 7.70 inch	25784241

**CHEVETTE 1976 - 1987**

Imagen	Clave del Producto y Descripción	Detalles	OEM
	<b>CV11030</b> Buje De Horquilla & Tijera	Chasis (Delantero / Trasero) : Delantero Peso : 0.211 kg / 0.465 lb	360747, 366746 462233, 475305 8942132950
	<b>CV11031</b> Buje De Horquilla & Tijera	Chasis (Delantero / Trasero) : Delantero Peso : 0.2 kg / 0.441 lb	360747, 366746 462233, 475305 8942132950
	<b>CV11802</b> Buje De Horquilla & Tijera	Chasis (Delantero / Trasero) : Delantero Peso : 0.5 kg / 1.102 lb Nota : KIT = CV11030 + CV11031	360747, 366746 462233, 475305 8942132950

\* Nombres de los vehículos, marcas, modelos, símbolos y logos, número OE y otros números de terceros en el sitio web y catálogo solo son con fines de referencia.

**CLASSIC**
**2004 - 2005**

Imagen	Clave del Producto y Descripción	Detalles	OEM
	<b>CV4057</b> Tornillo Estabilizador	Peso : 0.188 kg / 0.414 lb Tipo de Material : Metal	22601062
	<b>CV4058</b> Tornillo Estabilizador	Peso : 0.188 kg / 0.414 lb Tipo de Material : Metal	22601060

**COBALT**
**2005 - 2010**

Imagen	Clave del Producto y Descripción	Detalles	OEM
	<b>CV1027</b> Rotula	Peso : 0,656 kg / 1.446 lb	15240086, 15240089 15240092, 15240093 15803768, 15803769 19207818, 19207819 25984680, 25984681
	<b>CV6050</b> Horquilla & Tijera	Peso : 3.874 kg / 8.541 lb Tipo de Material : Chapa Metálica	15240086, 15240093 15803769, 19207818 25984681
	<b>CV6051</b> Horquilla & Tijera	Peso : 3.874 kg / 8.541 lb Tipo de Material : Chapa Metálica	15240089, 15240092 15803768, 19207819 25984680

**OP8001 / Kit De Suspension Y Direccion**

**CORSA**

**2002 - 2008**

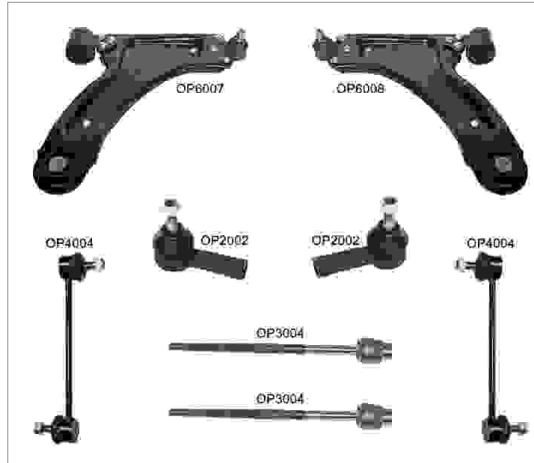

**Piezas del Kit**

Imagen	RIWCodigo / Nombre	OEM	OEM	RIWCodigo / Nombre	Imagen
	<b>OP2002</b> Terminal Exterior Delantero	1603009, 1603645 26011925, 26087868 324042, 324050 7840452	1603008, 26087867	<b>OP3004</b> Terminal Interior Delantero	
	<b>OP4004</b> Tornillo Estabilizador Delantero	350610, 4686606 4886606, 5236823 90496116	13140038, 24428978 352042, 352063	<b>OP6007</b> Horquillas Frontal Derecho Inferior	
	<b>OP6008</b> Horquillas Frontal Inferior Izquierdo	24428977, 352041 352061			

\* Nombres de los vehiculos, marcas, modelos, simbolos y logotipos, numero OE y otros numeros de terceros en el sitio web y catalogo solo son con fines de referencia.

**CORSICA I 1988 - 1990**

Imagen	Clave del Producto y Descripción	Detalles	OEM
	<b>CD4004</b> Tornillo Estabilizador	Peso : 0,264 kg / 0.582 lb Longitud : 184 mm / 7.24 inch	10023178, 10164176 C1VY5A484A

**CORSICA II 1991 - 1995**

Imagen	Clave del Producto y Descripción	Detalles	OEM
	<b>CD4004</b> Tornillo Estabilizador	Peso : 0,264 kg / 0.582 lb Longitud : 184 mm / 7.24 inch	10023178, 10164176 C1VY5A484A

**CORSICA III 1995 - 1996**

Imagen	Clave del Producto y Descripción	Detalles	OEM
	<b>CD4004</b> Tornillo Estabilizador	Peso : 0,264 kg / 0.582 lb Longitud : 184 mm / 7.24 inch	10023178, 10164176 C1VY5A484A

**CORVETTE C2 1963 - 1967**

Imagen	Clave del Producto y Descripción	Detalles	OEM
	<b>CD4005</b> Tornillo Estabilizador	Peso : 0,220 kg / 0.485 lb Longitud : 145 mm / 5.71 inch	25679063, 3879218

**CORVETTE C3 1968 - 1982**

Imagen	Clave del Producto y Descripción	Detalles	OEM
	<b>CD4005</b> Tornillo Estabilizador	Peso : 0,220 kg / 0.485 lb Longitud : 145 mm / 5.71 inch	25679063, 3879218

**CORVETTE C4 1984 - 1996**



Imagen	Clave del Producto y Descripción	Detalles	OEM
	<b>CV2231</b> TERMINAL EXTERIOR DELANTERO	Peso : 0,502 kg / 1.107 lb Longitud : 105 mm / 4.13 inch	26000001, 26071832 26086581, 7841637 7849266

\* Nombres de los vehículos, marcas, modelos, símbolos y logos, número OE y otros números de terceros en el sitio web y catálogo solo son con fines de referencia.

**CORVETTE C5 1997 - 2004**

Imagen	Clave del Producto y Descripción	Detalles	OEM
	<b>CV2231</b> TERMINAL EXTERIOR DELANTERO	Peso : 0,502 kg / 1.107 lb Longitud : 105 mm / 4.13 inch	26000001, 26071832 26086581, 7841637 7849266

**CRUZE I J300, J305, J3008 2009 -**

Imagen	Clave del Producto y Descripción	Detalles	OEM
	<b>VX12013</b> Soporte De Motor	Posicion : Derecha Peso : 1,970 kg / 4.343 lb	13294212, 13347449 684223, 684315 684411
	<b>VX12014</b> Soporte De Motor	Posicion : Derecha Peso : 2,000 kg / 4.409 lb	13248476, 13347450 684135, 684320
	<b>VX12016</b> Soporte De Motor	Posicion : Derecha Peso : 1,655 kg / 3.649 lb	13248549, 682065
	<b>VX12017</b> Soporte De Motor	Posicion : Izquierdo Peso : 1,700 kg / 3.748 lb	13248544, 682050
	<b>VX12024</b> Soporte De Motor	Peso : 1,400 kg / 3.086 lb	13248599, 684215
	<b>VX12030</b> Soporte De Motor	Chasis (Delantero / Trasero) : Delantero Peso : 0,800 kg / 1.764 lb	13248575, 684214

**CRUZE II 2016 -**

Imagen	Clave del Producto y Descripción	Detalles	OEM
	<b>OP20423031</b> Terminales Completas	Peso : 1,050 kg / 2.315 lb Terminal Exterior : OP2042 Terminal Interior : OP3031	
	<b>OP20433031</b> Terminales Completas	Peso : 1,050 kg / 2.315 lb Terminal Exterior : OP2043 Terminal Interior : OP3031	

\* Nombres de los vehículos, marcas, modelos, símbolos y logos, número OE y otros números de terceros en el sitio web y catálogo solo son con fines de referencia.

**EL CAMINO II 1964 - 1967**

Imagen	Clave del Producto y Descripción	Detalles	OEM
	<b>CV4056</b> Tornillo Estabilizador	Peso : 0,182 kg / 0.401 lb Longitud : 195,5 mm / 7.70 inch	25784241

**EL CAMINO III 1968 - 1972**

Imagen	Clave del Producto y Descripción	Detalles	OEM
	<b>CV4056</b> Tornillo Estabilizador	Peso : 0,182 kg / 0.401 lb Longitud : 195,5 mm / 7.70 inch	25784241

**EL CAMINO IV 1973 - 1977**

Imagen	Clave del Producto y Descripción	Detalles	OEM
	<b>CD4004</b> Tornillo Estabilizador	Peso : 0,264 kg / 0.582 lb Longitud : 184 mm / 7.24 inch	10023178, 10164176 C1VY5A484A

**EQUINOX I 2005 - 2009**

Imagen	Clave del Producto y Descripción	Detalles	OEM
	<b>CV4054</b> Tornillo Estabilizador	Peso : 0,191 kg / 0.421 lb Longitud : 69.6 mm / 2.74 inch	15791211, 22692175

**EXPRESS 1500 1996 - 2002**

Imagen	Clave del Producto y Descripción	Detalles	OEM
	<b>CV1035</b> RÓTULA FRONTAL SUPERIOR	Peso : 0,668 kg / 1.473 lb	15575901, 15617715 15634385, 15634904 15659518, 15687080

**EXPRESS 2500 1996 - 2002**

Imagen	Clave del Producto y Descripción	Detalles	OEM
	<b>CV1035</b> RÓTULA FRONTAL SUPERIOR	Peso : 0,668 kg / 1.473 lb	15575901, 15617715 15634385, 15634904 15659518, 15687080

\* Nombres de los vehículos, marcas, modelos, símbolos y logos, número OE y otros números de terceros en el sitio web y catálogo solo son con fines de referencia.



**EXPRESS 2500**
**2003 - 2011**

Imagen	Clave del Producto y Descripción	Detalles	OEM
	<b>CV3037</b> Terminal interior	Peso : 0,692 kg / 1.526 lb Longitud : 331,5 mm / 13.05 inch	12479168, 19149613 19257595

**EXPRESS 3500**
**2003 - 2011**

Imagen	Clave del Producto y Descripción	Detalles	OEM
	<b>CV3037</b> Terminal interior	Peso : 0,692 kg / 1.526 lb Longitud : 331,5 mm / 13.05 inch	12479168, 19149613 19257595

**EXPRESS 4500**
**2011 - 2017**

Imagen	Clave del Producto y Descripción	Detalles	OEM
	<b>CV3037</b> Terminal interior	Peso : 0,692 kg / 1.526 lb Longitud : 331,5 mm / 13.05 inch	12479168, 19149613 19257595

**HHR**
**2006 - 2011**

Imagen	Clave del Producto y Descripción	Detalles	OEM
	<b>CV1027</b> Rotula	Peso : 0,656 kg / 1.446 lb	15240086, 15240089 15240092, 15240093 15803768, 15803769 19207818, 19207819 25984680, 25984681
	<b>CV6050</b> Horquilla & Tijera	Peso : 3.874 kg / 8.541 lb Tipo de Material : Chapa Metálica	15240086, 15240093 15803769, 19207818 25984681
	<b>CV6051</b> Horquilla & Tijera	Peso : 3.874 kg / 8.541 lb Tipo de Material : Chapa Metálica	15240089, 15240092 15803768, 19207819 25984680

**IMPALA**
**IX**
**1994 - 1997**

Imagen	Clave del Producto y Descripción	Detalles	OEM
	<b>CD4004</b> Tornillo Estabilizador	Peso : 0,264 kg / 0.582 lb Longitud : 184 mm / 7.24 inch	10023178, 10164176 C1VY5A484A

\* Nombres de los vehículos, marcas, modelos, símbolos y logos, número OE y otros números de terceros en el sitio web y catálogo solo son con fines de referencia.

**IMPALA VII 1971 - 1976**

Imagen	Clave del Producto y Descripción	Detalles	OEM
	<b>CV1034</b> RÓTULA FRONTAL INFERIOR	Peso : 0,913 kg / 2.013 lb	7808865, 7814131 88965475, 9754378 9761498, 9766421
	<b>CD4004</b> Tornillo Estabilizador	Peso : 0,264 kg / 0.582 lb Longitud : 184 mm / 7.24 inch	10023178, 10164176 C1VY5A484A

**IMPALA VIII 1977 - 1985**

Imagen	Clave del Producto y Descripción	Detalles	OEM
	<b>CD4004</b> Tornillo Estabilizador	Peso : 0,264 kg / 0.582 lb Longitud : 184 mm / 7.24 inch	10023178, 10164176 C1VY5A484A

**IMPALA X 2000 - 2005**

Imagen	Clave del Producto y Descripción	Detalles	OEM
	<b>CV3030</b> Terminal interior	Peso : 0,647 kg / 1.426 lb Longitud : 324,5 mm / 12.78 inch	26003751, 26003759 26012282, 26021769

**IMPALA XI 2005 - 2013**

Imagen	Clave del Producto y Descripción	Detalles	OEM
	<b>CV3030</b> Terminal interior	Peso : 0,647 kg / 1.426 lb Longitud : 324,5 mm / 12.78 inch	26003751, 26003759 26012282, 26021769

**IMPALA LIMITED 2014 - 2016**

Imagen	Clave del Producto y Descripción	Detalles	OEM
	<b>CV3030</b> Terminal interior	Peso : 0,647 kg / 1.426 lb Longitud : 324,5 mm / 12.78 inch	26003751, 26003759 26012282, 26021769

**K1500 PICKUP 1988 - 1999**

Imagen	Clave del Producto y Descripción	Detalles	OEM
	<b>CV1035</b> RÓTULA FRONTAL SUPERIOR	Peso : 0,668 kg / 1.473 lb	15575901, 15617715 15634385, 15634904 15659518, 15687080

**K1500 SUBURBAN 1992 - 1999**

Imagen	Clave del Producto y Descripción	Detalles	OEM
	<b>CV1035</b> RÓTULA FRONTAL SUPERIOR	Peso : 0,668 kg / 1.473 lb	15575901, 15617715 15634385, 15634904 15659518, 15687080

**K2500 PICKUP 1988 - 1999**

Imagen	Clave del Producto y Descripción	Detalles	OEM
	<b>CV1035</b> RÓTULA FRONTAL SUPERIOR	Peso : 0,668 kg / 1.473 lb	15575901, 15617715 15634385, 15634904 15659518, 15687080

**KINGSWOOD VII 1971 - 1972**

Imagen	Clave del Producto y Descripción	Detalles	OEM
	<b>CV1034</b> RÓTULA FRONTAL INFERIOR	Peso : 0,913 kg / 2.013 lb	7808865, 7814131 88965475, 9754378 9761498, 9766421

**LACETTI J200 2003 - 2012**

Imagen	Clave del Producto y Descripción	Detalles	OEM
	<b>CV11029</b> BUJES INFERIOR	Chasis (Delantero / Trasero) : Delantero Posición : Peso : 0.355 kg / 0.783 lb	96261107, 96431044

**LUMINA I 1990 - 1994**

Imagen	Clave del Producto y Descripción	Detalles	OEM
	<b>CV3030</b> Terminal interior	Peso : 0,647 kg / 1.426 lb Longitud : 324,5 mm / 12.78 inch	26003751, 26003759 26012282, 26021769

\* Nombres de los vehículos, marcas, modelos, símbolos y logos, número OE y otros números de terceros en el sitio web y catálogo solo son con fines de referencia.

**LUMINA II 1995 - 2001**

Imagen	Clave del Producto y Descripción	Detalles	OEM
	<b>CV3030</b> Terminal interior	Peso : 0,647 kg / 1.426 lb Longitud : 324,5 mm / 12.78 inch	26003751, 26003759 26012282, 26021769

**MALIBU I 1964 - 1967**

Imagen	Clave del Producto y Descripción	Detalles	OEM
	<b>CV4056</b> Tornillo Estabilizador	Peso : 0,182 kg / 0.401 lb Longitud : 195,5 mm / 7.70 inch	25784241

**MALIBU III 1973 - 1977**

Imagen	Clave del Producto y Descripción	Detalles	OEM
	<b>CD4004</b> Tornillo Estabilizador	Peso : 0,264 kg / 0.582 lb Longitud : 184 mm / 7.24 inch	10023178, 10164176 C1VY5A484A

**MALIBU IX 2016 -**

Imagen	Clave del Producto y Descripción	Detalles	OEM
	<b>OP2051</b> TERMINAL EXTERIOR FRONTAL DERECHO	Peso : 0,828 kg / 1.825 lb Longitud : 112 mm / 4.41 inch	23449523
	<b>OP2052</b> TERMINAL EXTERIOR FRONTAL IZQUIERDO	Peso : 0,828 kg / 1.825 lb Longitud : 112 mm / 4.41 inch	23449522
	<b>OP3034</b> Terminal interior	Peso : 0,564 kg / 1.243 lb Longitud : 244 mm / 9.61 inch Tamaño de la Rosca : M16X1,5 Diámetro de Cuerda del Perno : M14X1,5	23449526
	<b>OP4031</b> Tornillo Estabilizador	Peso : 0,394 kg / 0.869 lb Tipo de Material : Metal Longitud : 274 mm / 10.79 inch	23322794, 84077103
	<b>OP4032</b> Tornillo Estabilizador	Peso : 0,394 kg / 0.869 lb Tipo de Material : Metal Longitud : 274 mm / 10.79 inch	23322795, 84077102

\* Nombres de los vehículos, marcas, modelos, símbolos y logos, número OE y otros números de terceros en el sitio web y catálogo solo son con fines de referencia.

**MALIBU IX 2016 -**

Imagen	Clave del Producto y Descripción	Detalles	OEM
	<b>OP11057</b> Buje De Horquilla & Tijera	Chasis (Delantero / Trasero) : Delantero Posicion : Inferior Grande Peso : 0.69 kg / 1.521 lb	23167662*, 84198829* 84198832*, 84198833*
	<b>OP11058</b> Buje De Horquilla & Tijera	Chasis (Delantero / Trasero) : Delantero Posicion : Inferior Chico Peso : 0.54 kg / 1.190 lb	23167662*, 84198829* 84198832*, 84198833*

**MALIBU V 1997 - 2003**

Imagen	Clave del Producto y Descripción	Detalles	OEM
	<b>CV1036</b> Rotula	Peso : 0,548 kg / 1.208 lb	10365842*, 22157023* 88967438*
	<b>CV4057</b> Tornillo Estabilizador	Peso : 0.188 kg / 0.414 lb Tipo de Material : Metal	22601062
	<b>CV4058</b> Tornillo Estabilizador	Peso : 0.188 kg / 0.414 lb Tipo de Material : Metal	22601060

**MALIBU VI 2004 - 2007**

Imagen	Clave del Producto y Descripción	Detalles	OEM
	<b>CV3034</b> Terminal interior	Peso : 0,595 kg / 1.312 lb Longitud : 280 mm / 11.02 inch	15267582, 15944072 15944097, 19256420 20995477, 22687091
	<b>CV9004</b> Horquilla & Tijera	Peso : 2,078 kg / 4.581 lb Tipo de Material : Chapa Metálica	15292403
	<b>CV9005</b> Horquilla & Tijera	Peso : 2,078 kg / 4.581 lb Tipo de Material : Chapa Metálica	15292404
	<b>CV9006</b> Horquilla & Tijera	Peso : 2,228 kg / 4.912 lb Tipo de Material : Chapa Metálica	15292405

\* Nombres de los vehículos, marcas, modelos, símbolos y logos, número OE y otros números de terceros en el sitio web y catálogo solo son con fines de referencia.

**MALIBU VI 2004 - 2007**

Imagen	Clave del Producto y Descripción	Detalles	OEM
	<b>CV9007</b> Horquilla & Tijera	Peso : 2,228 kg / 4.912 lb Tipo de Material : Chapa Metálica	15292406

**MALIBU VII 2008 - 2012**

Imagen	Clave del Producto y Descripción	Detalles	OEM
	<b>CV3034</b> Terminal interior	Peso : 0,595 kg / 1.312 lb Longitud : 280 mm / 11.02 inch	15267582, 15944072 15944097, 19256420 20995477, 22687091
	<b>CV9004</b> Horquilla & Tijera	Peso : 2,078 kg / 4.581 lb Tipo de Material : Chapa Metálica	15292403
	<b>CV9005</b> Horquilla & Tijera	Peso : 2,078 kg / 4.581 lb Tipo de Material : Chapa Metálica	15292404

**MONTE CARLO I 1970 - 1972**

Imagen	Clave del Producto y Descripción	Detalles	OEM
	<b>CV4056</b> Tornillo Estabilizador	Peso : 0,182 kg / 0.401 lb Longitud : 195,5 mm / 7.70 inch	25784241

**MONTE CARLO II 1973 - 1977**

Imagen	Clave del Producto y Descripción	Detalles	OEM
	<b>CD4004</b> Tornillo Estabilizador	Peso : 0,264 kg / 0.582 lb Longitud : 184 mm / 7.24 inch	10023178, 10164176 C1VY5A484A

**MONTE CARLO V 1995 - 1999**

Imagen	Clave del Producto y Descripción	Detalles	OEM
	<b>CV3030</b> Terminal interior	Peso : 0,647 kg / 1.426 lb Longitud : 324,5 mm / 12.78 inch	26003751, 26003759 26012282, 26021769

\* Nombres de los vehículos, marcas, modelos, símbolos y logos, número OE y otros números de terceros en el sitio web y catálogo solo son con fines de referencia.

**MONTE CARLO VI 2002 - 2007**

Imagen	Clave del Producto y Descripción	Detalles	OEM
	<b>CV3030</b> Terminal interior	Peso : 0,647 kg / 1.426 lb Longitud : 324,5 mm / 12.78 inch	26003751, 26003759 26012282, 26021769

**NOVA 1975 - 1979**

Imagen	Clave del Producto y Descripción	Detalles	OEM
	<b>CD4004</b> Tornillo Estabilizador	Peso : 0,264 kg / 0.582 lb Longitud : 184 mm / 7.24 inch	10023178, 10164176 C1VY5A484A

**NUBIRA 2003 - 2009**

Imagen	Clave del Producto y Descripción	Detalles	OEM
	<b>CV11029</b> BUJES INFERIOR	Chasis (Delantero / Trasero) : Delantero Posicion : Peso : 0.355 kg / 0.783 lb	96261107, 96431044

**OPTRA J200 2003 - 2012**

Imagen	Clave del Producto y Descripción	Detalles	OEM
	<b>CV11029</b> BUJES INFERIOR	Chasis (Delantero / Trasero) : Delantero Posicion : Peso : 0.355 kg / 0.783 lb	96261107, 96431044

**ORLANDO 2011 -**

Imagen	Clave del Producto y Descripción	Detalles	OEM
	<b>VX12016</b> Soporte De Motor	Posicion : Derecha Peso : 1,655 kg / 3.649 lb	13248549, 682065
	<b>VX12017</b> Soporte De Motor	Posicion : Izquierdo Peso : 1,700 kg / 3.748 lb	13248544, 682050

**REZZO U100 2004 - 2009**

Imagen	Clave del Producto y Descripción	Detalles	OEM
	<b>CV11029</b> BUJES INFERIOR	Chasis (Delantero / Trasero) : Delantero Posicion : Peso : 0.355 kg / 0.783 lb	96261107, 96431044

**S-10 PICKUP 1994 - 2005**

Imagen	Clave del Producto y Descripción	Detalles	OEM
	<b>CV4055</b> Tornillo Estabilizador	Peso : 0,320 kg / 0.705 lb Longitud : 118 mm / 4.65 inch	15996064

**SILVERADO 1500 GMT800 1999 - 2006**

Imagen	Clave del Producto y Descripción	Detalles	OEM
	<b>CV1037</b> Rotula	Peso : 1,164 kg / 2.566 lb	15015515*, 15750786*

**SILVERADO 2500 2007 - 2013**

Imagen	Clave del Producto y Descripción	Detalles	OEM
	<b>CV3036</b> Terminal interior	Peso : 0,835 kg / 1.841 lb Longitud : 324 mm / 12.76 inch	19256660, 22913605

**SILVERADO 2500 2014 - 2019**

Imagen	Clave del Producto y Descripción	Detalles	OEM
	<b>CV3036</b> Terminal interior	Peso : 0,835 kg / 1.841 lb Longitud : 324 mm / 12.76 inch	19256660, 22913605

**SILVERADO 3500 2007 - 2019**

Imagen	Clave del Producto y Descripción	Detalles	OEM
	<b>CV3036</b> Terminal interior	Peso : 0,835 kg / 1.841 lb Longitud : 324 mm / 12.76 inch	19256660, 22913605

\* Nombres de los vehículos, marcas, modelos, símbolos y logos, número OE y otros números de terceros en el sitio web y catálogo solo son con fines de referencia.



**SONIC T300 2012 - 2016**

Imagen	Clave del Producto y Descripción	Detalles	OEM
	<b>CV12019</b> Soporte De Motor	Chasis (Delantero / Trasero) : Delantero Posicion : Superior Izquierdo Peso : 0.715 kg / 1.576 lb	95463563

**SPARK M400 2016 - 2022**

Imagen	Clave del Producto y Descripción	Detalles	OEM
	<b>OP3033</b> Terminal interior	Peso : 0,481 kg / 1.060 lb Longitud : 248 mm / 9.76 inch	1609224, 95371542

**SSR 2003 - 2006**

Imagen	Clave del Producto y Descripción	Detalles	OEM
	<b>CV3035</b> Terminal interior	Peso : 0,534 kg / 1.177 lb Longitud : 135 mm / 5.31 inch	26100288, 8261002880

**SUBURBAN 1500 2000 - 2006**

Imagen	Clave del Producto y Descripción	Detalles	OEM
	<b>CD9001</b> Horquilla & Tijera	Peso : 3,304 kg / 7.284 lb Tipo de Material : Chapa Metálica	22868629

**SUBURBAN 1500 2007 - 2014**

Imagen	Clave del Producto y Descripción	Detalles	OEM
	<b>CD9001</b> Horquilla & Tijera	Peso : 3,304 kg / 7.284 lb Tipo de Material : Chapa Metálica	22868629

**TAHOE GMT400 1995 - 1999**

Imagen	Clave del Producto y Descripción	Detalles	OEM
	<b>CV1035</b> RÓTULA FRONTAL SUPERIOR	Peso : 0,668 kg / 1.473 lb	15575901, 15617715 15634385, 15634904 15659518, 15687080

\* Nombres de los vehículos, marcas, modelos, símbolos y logos, número OE y otros números de terceros en el sitio web y catálogo solo son con fines de referencia.

**TAHOE GMT400 1995 - 1999**

Imagen	Clave del Producto y Descripción	Detalles	OEM
	<b>CD4004</b> Tornillo Estabilizador	Peso : 0,264 kg / 0.582 lb Longitud : 184 mm / 7.24 inch	10023178, 10164176 C1VY5A484A

**TAHOE GMT800 2000 - 2006**

Imagen	Clave del Producto y Descripción	Detalles	OEM
	<b>CD9001</b> Horquilla & Tijera	Peso : 3,304 kg / 7.284 lb Tipo de Material : Chapa Metálica	22868629

**TAHOE GMT900 2007 - 2014**

Imagen	Clave del Producto y Descripción	Detalles	OEM
	<b>CD9001</b> Horquilla & Tijera	Peso : 3,304 kg / 7.284 lb Tipo de Material : Chapa Metálica	22868629

**TAHOE GMTK2UC-G 2015 - 2020**

Imagen	Clave del Producto y Descripción	Detalles	OEM
	<b>CD9001</b> Horquilla & Tijera	Peso : 3,304 kg / 7.284 lb Tipo de Material : Chapa Metálica	22868629

**TOWNSMAN IX 1971 - 1972**

Imagen	Clave del Producto y Descripción	Detalles	OEM
	<b>CV1034</b> RÓTULA FRONTAL INFERIOR	Peso : 0,913 kg / 2.013 lb	7808865, 7814131 88965475, 9754378 9761498, 9766421
	<b>CD4004</b> Tornillo Estabilizador	Peso : 0,264 kg / 0.582 lb Longitud : 184 mm / 7.24 inch	10023178, 10164176 C1VY5A484A

**TRAILBLAZER** **KC** **2002 - 2009**

Imagen	Clave del Producto y Descripción	Detalles	OEM
	<b>CV3035</b> Terminal interior	Peso : 0,534 kg / 1.177 lb Longitud : 135 mm / 5.31 inch	26100288, 8261002880
	<b>CV4056</b> Tornillo Estabilizador	Peso : 0,182 kg / 0.401 lb Longitud : 195,5 mm / 7.70 inch	25784241

**TRAVERSE** **II** **2018 -**

Imagen	Clave del Producto y Descripción	Detalles	OEM
	<b>BU2002</b> Terminal Exterior	Peso : 0,826 kg / 1.821 lb	23214216
	<b>BU2003</b> Terminal Exterior	Peso : 0,826 kg / 1.821 lb	23214215

**VEGA** **1971 - 1972**

Imagen	Clave del Producto y Descripción	Detalles	OEM
	<b>CD4004</b> Tornillo Estabilizador	Peso : 0,264 kg / 0.582 lb Longitud : 184 mm / 7.24 inch	10023178, 10164176 C1VY5A484A

**VOLT** **II** **2016 -**

Imagen	Clave del Producto y Descripción	Detalles	OEM
	<b>OP20423031</b> Terminales Completas	Peso : 1,050 kg / 2.315 lb Terminal Exterior : OP2042 Terminal Interior : OP3031	
	<b>OP20433031</b> Terminales Completas	Peso : 1,050 kg / 2.315 lb Terminal Exterior : OP2043 Terminal Interior : OP3031	

**ZAFIRA****F75****2000 - 2012**

Imagen	Clave del Producto y Descripción	Detalles	OEM
	<b>OP3035</b> Terminal interior	Peso : 0,570 kg / 1.257 lb Longitud : 284 mm / 11.18 inch	1603003, 1603644

**RIW<sup>®</sup>**

**CHRYSLER**

**300**
**2005 - 2010**

Imagen	Clave del Producto y Descripción	Detalles	OEM
	<b>DO9004</b> Horquilla & Tijera	Peso : 0,888 kg / 1.958 lb Tipo de Material : Tubo De Acero	4782936AA, 4782936AB 68051638AA, 68051638AB
	<b>DO9005</b> Horquilla & Tijera	Peso : 0,888 kg / 1.958 lb Tipo de Material : Tubo De Acero	4782937AA, 4782937AB 68051639AA, 68051639AB
	<b>DO9006</b> Horquilla & Tijera	Peso : 0,812 kg / 1.790 lb Tipo de Material : Chapa Metálica	4782735AA, 4782745AB 4895460AA, 68045329AA 68045329AB, 68045330AA 68045330AB, 68045330AC 68206294AA, 68206294AB

**300**
**2011 - 2015**

Imagen	Clave del Producto y Descripción	Detalles	OEM
	<b>DO9004</b> Horquilla & Tijera	Peso : 0,888 kg / 1.958 lb Tipo de Material : Tubo De Acero	4782936AA, 4782936AB 68051638AA, 68051638AB
	<b>DO9005</b> Horquilla & Tijera	Peso : 0,888 kg / 1.958 lb Tipo de Material : Tubo De Acero	4782937AA, 4782937AB 68051639AA, 68051639AB
	<b>DO9006</b> Horquilla & Tijera	Peso : 0,812 kg / 1.790 lb Tipo de Material : Chapa Metálica	4782735AA, 4782745AB 4895460AA, 68045329AA 68045329AB, 68045330AA 68045330AB, 68045330AC 68206294AA, 68206294AB

**300**
**2015 -**

Imagen	Clave del Producto y Descripción	Detalles	OEM
	<b>DO9004</b> Horquilla & Tijera	Peso : 0,888 kg / 1.958 lb Tipo de Material : Tubo De Acero	4782936AA, 4782936AB 68051638AA, 68051638AB
	<b>DO9005</b> Horquilla & Tijera	Peso : 0,888 kg / 1.958 lb Tipo de Material : Tubo De Acero	4782937AA, 4782937AB 68051639AA, 68051639AB
	<b>DO9006</b> Horquilla & Tijera	Peso : 0,812 kg / 1.790 lb Tipo de Material : Chapa Metálica	4782735AA, 4782745AB 4895460AA, 68045329AA 68045329AB, 68045330AA 68045330AB, 68045330AC 68206294AA, 68206294AB

\* Nombres de los vehículos, marcas, modelos, símbolos y logos, número OE y otros números de terceros en el sitio web y catálogo solo son con fines de referencia.

**ASPEN**
**2007 - 2009**

Imagen	Clave del Producto y Descripción	Detalles	OEM
	<b>DO1008</b> Rotula	Peso : 0,768 kg / 1.693 lb Medida de Cono : Ø16,8 Diámetro de Cuerda del Perno : M16X1,5 Diámetro del Cuerpo de la Rotu : Ø50	5143570AA
	<b>DO3007</b> Terminal interior	Peso : 0,732 kg / 1.614 lb Longitud : 259 mm / 10.20 inch Tamaño de la Rosca : M24X1,5 Diámetro de Cuerda del Perno : M16X1,5	52113237AB, 52855758AF 68040226AA, 68040226AB
	<b>DO11010</b> Buje De Horquilla & Tijera	Chasis (Delantero / Trasero) : Delantero Posicion : Superior Peso : 0.221 kg / 0.487 lb	52106580AB, MB00A868430
	<b>DO11010K</b> Buje De Horquilla & Tijera	Chasis (Delantero / Trasero) : Delantero Posicion : Superior Peso : 0.442 kg / 0.974 lb Nota : YCT13566 X 2	52106580AB, MB00A868430

**CROSSFIRE**
**2004 - 2008**

Imagen	Clave del Producto y Descripción	Detalles	OEM
	<b>ME12059</b> Soporte De Transmision	Chasis (Delantero / Trasero) : Delantero Peso : 0,519 kg / 1.144 lb	1402401218, 1402401718 2122400318, 2202400118 2202400418, 5101457AA

**NEW YORKER**
**IX**
**1974 - 1978**

Imagen	Clave del Producto y Descripción	Detalles	OEM
	<b>CV4056</b> Tornillo Estabilizador	Peso : 0,182 kg / 0.401 lb Longitud : 195,5 mm / 7.70 inch	25784241

**NEWPORT**
**VI**
**1974 - 1978**

Imagen	Clave del Producto y Descripción	Detalles	OEM
	<b>CV4056</b> Tornillo Estabilizador	Peso : 0,182 kg / 0.401 lb Longitud : 195,5 mm / 7.70 inch	25784241

**SEBRING****ST22, JR****2001 - 2006**

Imagen	Clave del Producto y Descripción	Detalles	OEM
	<b>MI3025</b> Terminal interior	Peso : 0,624 kg / 1.376 lb Longitud : 316 mm / 12.44 inch Tamaño de la Rosca : M14X1,5 Diámetro de Cuerda del Perno : M14X1,5	MR519046







**RIW®**

**CITROEN**

**BERLINGO**
**I MF**
**1996 - 2007**

Imagen	Clave del Producto y Descripción	Detalles	OEM
	<b>PE11018K</b> Buje De Horquilla & Tijera	Posicion : Izquierda Y Derecha Peso : 0,236 kg / 0.520 lb Nota : BEŞİK BURCU KIT	5131.47, 513147

**C3**
**II**
**2009 - 2016**

Imagen	Clave del Producto y Descripción	Detalles	OEM
	<b>CI6029</b> Horquilla & Tijera	Peso : 3,408 kg / 7.513 lb Tipo de Material : Chapa Metálica	9803286480
	<b>CI6029J</b> Horquilla & Tijera	Peso : 2,874 kg / 6.336 lb Tipo de Material : Chapa Metálica	9803286480
	<b>CI6030</b> Horquilla & Tijera	Peso : 3,408 kg / 7.513 lb Tipo de Material : Chapa Metálica	9803286580
	<b>CI6030J</b> Horquilla & Tijera	Peso : 2,874 kg / 6.336 lb Tipo de Material : Chapa Metálica	9803286580

**C3**
**III**
**2016 -**

Imagen	Clave del Producto y Descripción	Detalles	OEM
	<b>CI6029</b> Horquilla & Tijera	Peso : 3,408 kg / 7.513 lb Tipo de Material : Chapa Metálica	9803286480
	<b>CI6029J</b> Horquilla & Tijera	Peso : 2,874 kg / 6.336 lb Tipo de Material : Chapa Metálica	9803286480
	<b>CI6030</b> Horquilla & Tijera	Peso : 3,408 kg / 7.513 lb Tipo de Material : Chapa Metálica	9803286580
	<b>CI6030J</b> Horquilla & Tijera	Peso : 2,874 kg / 6.336 lb Tipo de Material : Chapa Metálica	9803286580

\* Nombres de los vehículos, marcas, modelos, símbolos y logos, número OE y otros números de terceros en el sitio web y catálogo solo son con fines de referencia.

**C4 PICASSO**
**II**
**2013 - 2018**

Imagen	Clave del Producto y Descripción	Detalles	OEM
	<b>CI6033</b> Horquilla & Tijera	Peso : 3,918 kg / 8.638 lb Tipo de Material : Chapa Metálica	9678311280
	<b>CI6034</b> Horquilla & Tijera	Peso : 3,918 kg / 8.638 lb Tipo de Material : Chapa Metálica	9678311380

**DS3**
**I**
**2009 - 2018**

Imagen	Clave del Producto y Descripción	Detalles	OEM
	<b>PE3026</b> Terminal interior	Peso : 0,487 kg / 1.074 lb Longitud : 215,5 mm / 8.48 inch	1611158680
	<b>CI6029</b> Horquilla & Tijera	Peso : 3,408 kg / 7.513 lb Tipo de Material : Chapa Metálica	9803286480
	<b>CI6029J</b> Horquilla & Tijera	Peso : 2,874 kg / 6.336 lb Tipo de Material : Chapa Metálica	9803286480
	<b>CI6030</b> Horquilla & Tijera	Peso : 3,408 kg / 7.513 lb Tipo de Material : Chapa Metálica	9803286580
	<b>CI6030J</b> Horquilla & Tijera	Peso : 2,874 kg / 6.336 lb Tipo de Material : Chapa Metálica	9803286580

**JUMPER**
**III**
**2006 - 2014**

Imagen	Clave del Producto y Descripción	Detalles	OEM
	<b>FI12176</b> Soporte De Motor	Chasis (Delantero / Trasero) : Delantero Peso : 1,430 kg / 3.153 lb Tipo de Material : Soporte De Transmision	1344335080, 1854.25

**JUMPER IV 2015 -**

Imagen	Clave del Producto y Descripción	Detalles	OEM
	<b>CI6031</b> Horquilla & Tijera	Peso : 7,054 kg / 15.551 lb Tipo de Material : Döküm Çelik	1374222080, 1612735580
	<b>CI6032</b> Horquilla & Tijera	Peso : 7,054 kg / 15.551 lb Tipo de Material : Döküm Çelik	1374223080, 1612735680

**JUMPY III 2016 -**





Imagen	Clave del Producto y Descripción	Detalles	OEM
	<b>CI1008</b> Rotula	Peso : 0,365 kg / 0.805 lb Medida de Cono : Ø18,5 Diámetro de Cuerda del Perno : M14X1,5 Diámetro del Cuerpo de la Rotu : M40X1,5	9818657580
	<b>CI2016</b> Terminal Exterior	Peso : 0,809 kg / 1.784 lb Longitud : 185 mm / 7.28 inch	9820340180, SU001-A7208
	<b>CI2017</b> Terminal Exterior	Peso : 0,809 kg / 1.784 lb Longitud : 185 mm / 7.28 inch	9820340080, SU001-A7207

**FI8006 / Kit De Suspensi?n Y Direccion**
**NEMO**
**2008 - 2014**

**Piezas del Kit**

Imagen	RIW Codigo / Nombre	OEM	OEM	RIW Codigo / Nombre	Imagen
	<b>CI3012</b> Terminal Interior Delantero	1608899780, 1630726680 1630726780, 1630726880 1630726980, 1663659480 1663659680, 1663659780 4001.77, 4001.CW	3817.87, 381787 77364569	<b>FI2042</b> Terminal Exterior Frontal Derecho	
	<b>FI2043</b> Terminal Exterior Frontal Izquierdo	3817.86, 381786 77364568	5087.65, 5087.70 5087.79, 508765 508770, 51704008 51815479, 51815480	<b>FI4013</b> Tornillo Estabilizador Delantero	
	<b>FI6059</b> Horquillas Frontal Inferior Izquierdo	3520.W3, 3520.Y4 3520W3, 51783057 51839040, 51895367 5352039, 55703230 55703629	3521.S6, 3521.V5 50511650, 51783056 51839039, 51895366 5352038, 55703231 55703627	<b>FI6060</b> Horquillas Frontal Derecho Inferior	

**NEMO**
**2008 - 2014**

Imagen	Clave del Producto y Descripción	Detalles	OEM
	<b>FI12014A</b> Soporte De Amortiguador	Chasis (Delantero / Trasero) : Delantero Posicion : Derecha Otro Lado del Artículo : FI12015A Peso : 0.86 kg / 1.896 lb Nota : AMORTISÖR TAKOZU YENİ TİP	5038.G7, 5038.J8 51804748, 51839931 51855157, 52023099 52109286
	<b>FI12015A</b> Soporte De Amortiguador	Chasis (Delantero / Trasero) : Delantero Posicion : Izquierdo Otro Lado del Artículo : FI12014A Peso : 0.86 kg / 1.896 lb Nota : AMORTISÖR TAKOZU YENİ TİP	5038.G8, 5038.J7 51804747, 51839975 51855158, 51928747 52023097
	<b>FI12804</b> Soporte De Amortiguador	Chasis (Delantero / Trasero) : Delantero Posicion : Derecho-Izquierdo Peso : 1.68 kg / 3.704 lb Nota : KIT = FI12014 FI12015	5038.G7, 5038.G8 5038.J7, 5038.J8 51804747, 51804748 51839931, 51839975 51855157, 51855158
	<b>FI12804A</b> Soporte De Amortiguador	Chasis (Delantero / Trasero) : Delantero Posicion : Derecho-Izquierdo Peso : 1.68 kg / 3.704 lb Nota : KIT = FI12014A FI12015A	5038.G7, 5038.G8 5038.J7, 5038.J8 51804747, 51804748 51839931, 51839975 51855157, 51855158
	<b>FI13016K</b> Cubre Polvo De Direccion	Peso : 0.164 kg / 0.362 lb	4066.95, 77363828 77364571

**SPACETOURER**
**2016 -**

Imagen	Clave del Producto y Descripción	Detalles	OEM
	<b>CI1008</b> Rotula	Peso : 0,365 kg / 0.805 lb Medida de Cono : Ø18,5 Diámetro de Cuerda del Perno : M14X1,5 Diámetro del Cuerpo de la Rotu : M40X1,5	9818657580
	<b>CI2016</b> Terminal Exterior	Peso : 0,809 kg / 1.784 lb Longitud : 185 mm / 7.28 inch	9820340180, SU001-A7208
	<b>CI2017</b> Terminal Exterior	Peso : 0,809 kg / 1.784 lb Longitud : 185 mm / 7.28 inch	9820340080, SU001-A7207

**XSARA**
**N1**
**1997 - 2005**

Imagen	Clave del Producto y Descripción	Detalles	OEM
	<b>PE11018K</b> Buje De Horquilla & Tijera	Posicion : Izquierda Y Derecha Peso : 0,236 kg / 0.520 lb Nota : BEŞİK BURCU KİT	5131.47, 513147

\* Nombres de los vehículos, marcas, modelos, símbolos y logos, número OE y otros números de terceros en el sitio web y catálogo solo son con fines de referencia.

**XSARA PICASSO**
**N68**
**1999 - 2012**

Imagen	Clave del Producto y Descripción	Detalles	OEM
	<b>PE11018K</b> Buje De Horquilla & Tijera	Posicion : Izquierda Y Derecha Peso : 0,236 kg / 0.520 lb Nota : BEŞİK BURCU KİT	5131.47, 513147

**ZX**
**N2**
**1991 - 1997**

Imagen	Clave del Producto y Descripción	Detalles	OEM
	<b>PE11018K</b> Buje De Horquilla & Tijera	Posicion : Izquierda Y Derecha Peso : 0,236 kg / 0.520 lb Nota : BEŞİK BURCU KİT	5131.47, 513147

**RIW<sup>®</sup>**

**CUPRA**



**ATECA**
**I**
**2018 -**

Imagen	Clave del Producto y Descripción	Detalles	OEM
	<b>AU11070</b> Buje De Horquilla & Tijera	Chasis (Delantero / Trasero) : Trasera Posicion : Inferior Peso : 0,100 kg / 0.220 lb	5Q0505171, 5Q0505311C 5Q0505311CSK, 5Q0505311D 5Q0505311DSK

**FORMENTOR**
**I**
**2021 -**

Imagen	Clave del Producto y Descripción	Detalles	OEM
	<b>AU11070</b> Buje De Horquilla & Tijera	Chasis (Delantero / Trasero) : Trasera Posicion : Inferior Peso : 0,100 kg / 0.220 lb	5Q0505171, 5Q0505311C 5Q0505311CSK, 5Q0505311D 5Q0505311DSK

**LEON**
**I**
**2020 -**

Imagen	Clave del Producto y Descripción	Detalles	OEM
	<b>AU11070</b> Buje De Horquilla & Tijera	Chasis (Delantero / Trasero) : Trasera Posicion : Inferior Peso : 0,100 kg / 0.220 lb	5Q0505171, 5Q0505311C 5Q0505311CSK, 5Q0505311D 5Q0505311DSK

**RIW<sup>®</sup>**

**DACIA**

**DOKKER**
**2012 - 2017**

Imagen	Clave del Producto y Descripción	Detalles	OEM
	<b>DC12022</b> Soporte De Suspensión	Posicion : Izquierda Y Derecha Peso : 0,335 kg / 0.739 lb	552401999R

**LOGAN**
**LS**
**2004 - 2012**

Imagen	Clave del Producto y Descripción	Detalles	OEM
	<b>RN13022K</b> Cubre Polvo De Direccion	Peso : 0.152 kg / 0.335 lb	4501260, 6001547607 6025 370 231, 6025370231 9161560

**LOGAN MCV**
**KS**
**2007 - 2013**

Imagen	Clave del Producto y Descripción	Detalles	OEM
	<b>RN13022K</b> Cubre Polvo De Direccion	Peso : 0.152 kg / 0.335 lb	4501260, 6001547607 6025 370 231, 6025370231 9161560

**SANDERO**
**2008 - 2012**

Imagen	Clave del Producto y Descripción	Detalles	OEM
	<b>RN13022K</b> Cubre Polvo De Direccion	Peso : 0.152 kg / 0.335 lb	4501260, 6001547607 6025 370 231, 6025370231 9161560

**RIW<sup>®</sup>**

**DAEWOO**

**REZZO****KLAU****2000 - 2011**

Imagen	Clave del Producto y Descripción	Detalles	OEM
	<b>CV11029</b> BUJES INFERIOR	Chasis (Delantero / Trasero) : Delantero Posicion : Peso : 0.355 kg / 0.783 lb	96261107, 96431044

**RIW<sup>®</sup>**

**DODGE**

**ATOS**

**2000 - 2012**

Imagen	Clave del Producto y Descripción	Detalles	OEM
	<p><b>HY1008A</b> Rotula</p>	<p>Peso : 0,250 kg / 0.551 lb Medida de Cono : Ø13,4 Diámetro de Cuerda del Perno : M12X1,25 Diámetro del Cuerpo de la Rotu : Ø36</p>	<p>52037530, 5453002000 54530-02000, 54530-02050 5453002500</p>

\* Nombres de los vehículos, marcas, modelos, símbolos y logos, número OE y otros números de terceros en el sitio web y catálogo solo son con fines de referencia.



**JP8001 / Kit De Suspension Y Direccion**

**CALIBER**

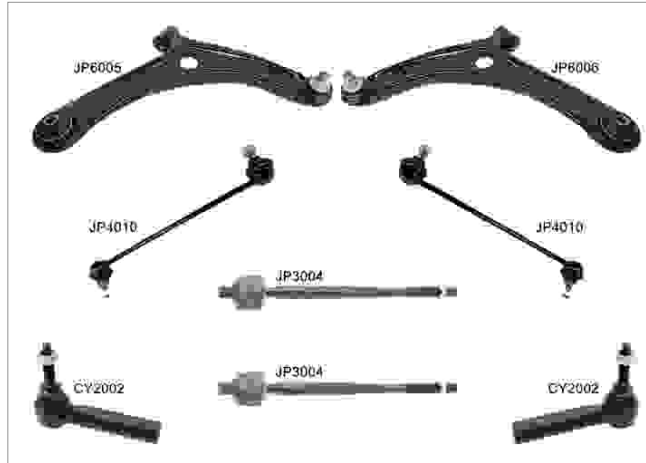
**2006 - 2012**



**Piezas del Kit**

Imagen	RIW Codigo / Nombre	OEM	OEM	RIW Codigo / Nombre	Imagen
	<b>CY2002</b> Terminal Exterior Delantero	05066373AB, 05183761AD 5066373AA, K05183761AA K05183761AB, K05183761AC K68014944AA, K68141058AA	68040224AA, K68040224AA	<b>JP3004</b> Terminal Interior Delantero	
	<b>JP4010</b> Tornillo Estabilizador Delantero	05174185AC, 5174185AC	05105040AE, 05105040AG 5105040AB, 5105040AD 5105040AE, 5105040AG 5105040AH	<b>JP6005</b> Horquillas Frontal Derecho Inferior	
	<b>JP6006</b> Horquillas Frontal Inferior Izquierdo	05105041AE, 05105041AH 5105041AB, 5105041AC 5105041AE, 5105041AH			

\* Nombres de los vehiculos, marcas, modelos, simbolos y logotipos, numero OE y otros numeros de terceros en el sitio web y catalogo solo son con fines de referencia.



**CHALLENGER I 1970 - 1974**

Imagen	Clave del Producto y Descripción	Detalles	OEM
	<b>CD4005</b> Tornillo Estabilizador	Peso : 0,220 kg / 0.485 lb Longitud : 145 mm / 5.71 inch	25679063, 3879218

**CHALLENGER II 1978 - 1983**

Imagen	Clave del Producto y Descripción	Detalles	OEM
	<b>CD4005</b> Tornillo Estabilizador	Peso : 0,220 kg / 0.485 lb Longitud : 145 mm / 5.71 inch	25679063, 3879218

**CHALLENGER III 2008 - 2014**

Imagen	Clave del Producto y Descripción	Detalles	OEM
	<b>DO9004</b> Horquilla & Tijera	Peso : 0,888 kg / 1.958 lb Tipo de Material : Tubo De Acero	4782936AA, 4782936AB 68051638AA, 68051638AB
	<b>DO9005</b> Horquilla & Tijera	Peso : 0,888 kg / 1.958 lb Tipo de Material : Tubo De Acero	4782937AA, 4782937AB 68051639AA, 68051639AB
	<b>DO9006</b> Horquilla & Tijera	Peso : 0,812 kg / 1.790 lb Tipo de Material : Chapa Metálica	4782735AA, 4782745AB 4895460AA, 68045329AA 68045329AB, 68045330AA 68045330AB, 68045330AC 68206294AA, 68206294AB

**CHALLENGER III FACELIFT 2015 -**

Imagen	Clave del Producto y Descripción	Detalles	OEM
	<b>DO9004</b> Horquilla & Tijera	Peso : 0,888 kg / 1.958 lb Tipo de Material : Tubo De Acero	4782936AA, 4782936AB 68051638AA, 68051638AB
	<b>DO9005</b> Horquilla & Tijera	Peso : 0,888 kg / 1.958 lb Tipo de Material : Tubo De Acero	4782937AA, 4782937AB 68051639AA, 68051639AB
	<b>DO9006</b> Horquilla & Tijera	Peso : 0,812 kg / 1.790 lb Tipo de Material : Chapa Metálica	4782735AA, 4782745AB 4895460AA, 68045329AA 68045329AB, 68045330AA 68045330AB, 68045330AC 68206294AA, 68206294AB

\* Nombres de los vehículos, marcas, modelos, símbolos y logos, número OE y otros números de terceros en el sitio web y catálogo solo son con fines de referencia.

**CHARGER I 1966 - 1967**

Imagen	Clave del Producto y Descripción	Detalles	OEM
	<b>CV4056</b> Tornillo Estabilizador	Peso : 0,182 kg / 0.401 lb Longitud : 195,5 mm / 7.70 inch	25784241

**CHARGER II 1968 - 1970**

Imagen	Clave del Producto y Descripción	Detalles	OEM
	<b>CV4056</b> Tornillo Estabilizador	Peso : 0,182 kg / 0.401 lb Longitud : 195,5 mm / 7.70 inch	25784241

**CHARGER VI 2006 - 2010**

Imagen	Clave del Producto y Descripción	Detalles	OEM
	<b>DO9004</b> Horquilla & Tijera	Peso : 0,888 kg / 1.958 lb Tipo de Material : Tubo De Acero	4782936AA, 4782936AB 68051638AA, 68051638AB
	<b>DO9005</b> Horquilla & Tijera	Peso : 0,888 kg / 1.958 lb Tipo de Material : Tubo De Acero	4782937AA, 4782937AB 68051639AA, 68051639AB
	<b>DO9006</b> Horquilla & Tijera	Peso : 0,812 kg / 1.790 lb Tipo de Material : Chapa Metálica	4782735AA, 4782745AB 4895460AA, 68045329AA 68045329AB, 68045330AA 68045330AB, 68045330AC 68206294AA, 68206294AB

**CHARGER VII 2011 - 2014**

Imagen	Clave del Producto y Descripción	Detalles	OEM
	<b>DO9004</b> Horquilla & Tijera	Peso : 0,888 kg / 1.958 lb Tipo de Material : Tubo De Acero	4782936AA, 4782936AB 68051638AA, 68051638AB
	<b>DO9005</b> Horquilla & Tijera	Peso : 0,888 kg / 1.958 lb Tipo de Material : Tubo De Acero	4782937AA, 4782937AB 68051639AA, 68051639AB
	<b>DO9006</b> Horquilla & Tijera	Peso : 0,812 kg / 1.790 lb Tipo de Material : Chapa Metálica	4782735AA, 4782745AB 4895460AA, 68045329AA 68045329AB, 68045330AA 68045330AB, 68045330AC 68206294AA, 68206294AB

\* Nombres de los vehículos, marcas, modelos, símbolos y logos, número OE y otros números de terceros en el sitio web y catálogo solo son con fines de referencia.

**CHARGER VII FACELIFT 2015 -**

Imagen	Clave del Producto y Descripción	Detalles	OEM
	<b>DO9004</b> Horquilla & Tijera	Peso : 0,888 kg / 1.958 lb Tipo de Material : Tubo De Acero	4782936AA, 4782936AB 68051638AA, 68051638AB
	<b>DO9005</b> Horquilla & Tijera	Peso : 0,888 kg / 1.958 lb Tipo de Material : Tubo De Acero	4782937AA, 4782937AB 68051639AA, 68051639AB
	<b>DO9006</b> Horquilla & Tijera	Peso : 0,812 kg / 1.790 lb Tipo de Material : Chapa Metálica	4782735AA, 4782745AB 4895460AA, 68045329AA 68045329AB, 68045330AA 68045330AB, 68045330AC 68206294AA, 68206294AB

**CORONET BW, CW 1966 - 1967**

Imagen	Clave del Producto y Descripción	Detalles	OEM
	<b>CV4056</b> Tornillo Estabilizador	Peso : 0,182 kg / 0.401 lb Longitud : 195,5 mm / 7.70 inch	25784241

**CORONET V 1968 - 1970**

Imagen	Clave del Producto y Descripción	Detalles	OEM
	<b>CV4056</b> Tornillo Estabilizador	Peso : 0,182 kg / 0.401 lb Longitud : 195,5 mm / 7.70 inch	25784241

**DAKOTA II 1997 - 2004**





Imagen	Clave del Producto y Descripción	Detalles	OEM
	<b>DO1006</b> RÓTULA FRONTAL INFERIOR	Peso : 0,784 kg / 1.728 lb	52106116, 52106116AA 52106117, 52106117AA 52106450AA, 52106451AA
	<b>DO1011</b> Rotula	Peso : 0,765 kg / 1.687 lb Medida de Cono : Ø18,2 Diámetro del Cuerpo de la Rotu : Ø50,1	52106222AA, 52106396AA 52106397AA
	<b>DO4017</b> Tornillo Estabilizador	Peso : 0,306 kg / 0.675 lb Tipo de Material : Metal Longitud : 173,5 mm / 6.83 inch	52038736, 52038736AB

\* Nombres de los vehículos, marcas, modelos, símbolos y logos, número OE y otros números de terceros en el sitio web y catálogo solo son con fines de referencia.

**DAKOTA II 1997 - 2004**

Imagen	Clave del Producto y Descripción	Detalles	OEM
	<b>JP4001</b> Tornillo Estabilizador	Peso : 0,403 kg / 0.888 lb Tipo de Material : Metal Longitud : 177 mm / 6.97 inch	52087863, 52088896AA 52106303A, 52106303AA 52106306AA

**DAKOTA III 2005 - 2011**

Imagen	Clave del Producto y Descripción	Detalles	OEM
	<b>DO1012</b> Rotula	Peso : 0,663 kg / 1.462 lb	05161685AB, 5161685AA 5161685AB
	<b>DO4016</b> Tornillo Estabilizador	Peso : 0,534 kg / 1.177 lb Longitud : 123,1 mm / 4.85 inch Nota : 2WD	05135731AC, 5135731AA 5135731AB, 5135731AC
	<b>JP4001</b> Tornillo Estabilizador	Peso : 0,403 kg / 0.888 lb Tipo de Material : Metal Longitud : 177 mm / 6.97 inch	52087863, 52088896AA 52106303A, 52106303AA 52106306AA
	<b>DO11010</b> Buje De Horquilla & Tijera	Chasis (Delantero / Trasero) : Delantero Posicion : Superior Peso : 0.221 kg / 0.487 lb	52106580AB, MB00A868430
	<b>DO11010K</b> Buje De Horquilla & Tijera	Chasis (Delantero / Trasero) : Delantero Posicion : Superior Peso : 0.442 kg / 0.974 lb Nota : YCT13566 X 2	52106580AB, MB00A868430

**DART III 1963 - 1966**

Imagen	Clave del Producto y Descripción	Detalles	OEM
	<b>CV4056</b> Tornillo Estabilizador	Peso : 0,182 kg / 0.401 lb Longitud : 195,5 mm / 7.70 inch	25784241

**DART IV 1967 - 1969**

Imagen	Clave del Producto y Descripción	Detalles	OEM
	<b>CV4056</b> Tornillo Estabilizador	Peso : 0,182 kg / 0.401 lb Longitud : 195,5 mm / 7.70 inch	25784241

\* Nombres de los vehículos, marcas, modelos, símbolos y logos, número OE y otros números de terceros en el sitio web y catálogo solo son con fines de referencia.

**DART IV 1ST FACELIFT 1970 - 1972**

Imagen	Clave del Producto y Descripción	Detalles	OEM
	<b>CV4056</b> Tornillo Estabilizador	Peso : 0,182 kg / 0.401 lb Longitud : 195,5 mm / 7.70 inch	25784241

**DART IV 2ND FACELIFT 1973 - 1976**

Imagen	Clave del Producto y Descripción	Detalles	OEM
	<b>CD4005</b> Tornillo Estabilizador	Peso : 0,220 kg / 0.485 lb Longitud : 145 mm / 5.71 inch	25679063, 3879218

**DURANGO I 1998 - 2003**

Imagen	Clave del Producto y Descripción	Detalles	OEM
	<b>DO1006</b> RÓTULA FRONTAL INFERIOR	Peso : 0,784 kg / 1.728 lb	52106116, 52106116AA 52106117, 52106117AA 52106450AA, 52106451AA
	<b>DO1011</b> Rotula	Peso : 0,765 kg / 1.687 lb Medida de Cono : Ø18,2 Diámetro del Cuerpo de la Rotu : Ø50,1	52106222AA, 52106396AA 52106397AA
	<b>DO4017</b> Tornillo Estabilizador	Peso : 0,306 kg / 0.675 lb Tipo de Material : Metal Longitud : 173,5 mm / 6.83 inch	52038736, 52038736AB

**DURANGO II 2004 - 2009**

Imagen	Clave del Producto y Descripción	Detalles	OEM
	<b>DO1008</b> Rotula	Peso : 0,768 kg / 1.693 lb Medida de Cono : Ø16,8 Diámetro de Cuerda del Perno : M16X1,5 Diámetro del Cuerpo de la Rotu : Ø50	5143570AA
	<b>DO3007</b> Terminal interior	Peso : 0,732 kg / 1.614 lb Longitud : 259 mm / 10.20 inch Tamaño de la Rosca : M24X1,5 Diámetro de Cuerda del Perno : M16X1,5	52113237AB, 52855758AF 68040226AA, 68040226AB
	<b>DO11010</b> Buje De Horquilla & Tijera	Chasis (Delantero / Trasero) : Delantero Posicion : Superior Peso : 0.221 kg / 0.487 lb	52106580AB, MB00A868430

\* Nombres de los vehículos, marcas, modelos, símbolos y logos, número OE y otros números de terceros en el sitio web y catálogo solo son con fines de referencia.

**DURANGO II 2004 - 2009**

Imagen	Clave del Producto y Descripción	Detalles	OEM
	<b>DO11010K</b> Buje De Horquilla & Tijera	Chasis (Delantero / Trasero) : Delantero Posicion : Superior Peso : 0.442 kg / 0.974 lb Nota : YCT13566 X 2	52106580AB, MB00A868430

**DURANGO III 2011 - 2013**

Imagen	Clave del Producto y Descripción	Detalles	OEM
	<b>JP9005</b> Horquilla & Tijera	Peso : 0,968 kg / 2.134 lb Tipo de Material : Tubo De Acero	52124830AC, 52124830AD

**DURANGO III 1ST FACELIFT 2014 - 2017**

Imagen	Clave del Producto y Descripción	Detalles	OEM
	<b>JP9005</b> Horquilla & Tijera	Peso : 0,968 kg / 2.134 lb Tipo de Material : Tubo De Acero	52124830AC, 52124830AD

**MAGNUM 2005 - 2008**

Imagen	Clave del Producto y Descripción	Detalles	OEM
	<b>DO9004</b> Horquilla & Tijera	Peso : 0,888 kg / 1.958 lb Tipo de Material : Tubo De Acero	4782936AA, 4782936AB 68051638AA, 68051638AB
	<b>DO9005</b> Horquilla & Tijera	Peso : 0,888 kg / 1.958 lb Tipo de Material : Tubo De Acero	4782937AA, 4782937AB 68051639AA, 68051639AB
	<b>DO9006</b> Horquilla & Tijera	Peso : 0,812 kg / 1.790 lb Tipo de Material : Chapa Metálica	4782735AA, 4782745AB 4895460AA, 68045329AA 68045329AB, 68045330AA 68045330AB, 68045330AC 68206294AA, 68206294AB

**MONACO III 1974 - 1977**

Imagen	Clave del Producto y Descripción	Detalles	OEM
	<b>CV4056</b> Tornillo Estabilizador	Peso : 0,182 kg / 0.401 lb Longitud : 195,5 mm / 7.70 inch	25784241

\* Nombres de los vehículos, marcas, modelos, símbolos y logos, número OE y otros números de terceros en el sitio web y catálogo solo son con fines de referencia.

**NITRO**
**2007 - 2012**

Imagen	Clave del Producto y Descripción	Detalles	OEM
	<b>JP1013</b> Rotula	Peso : 0,654 kg / 1.442 lb	52109986AH*, 52109987AH*
	<b>JP11005</b> Buje De Horquilla & Tijera	Chasis (Delantero / Trasero) : Delantero Posicion : Superior Peso : 0.147 kg / 0.324 lb	52088634AB, 52125369AA
	<b>JP11005K</b> Buje De Horquilla & Tijera	Chasis (Delantero / Trasero) : Delantero Posicion : Superior Peso : 0.294 kg / 0.648 lb Nota : JP11005 (X2)	52088634AB, 52125369AA

**RAM 1500**
**II**
**1994 - 2001**

Imagen	Clave del Producto y Descripción	Detalles	OEM
	<b>DO1007</b> Rotula	Peso : 0,506 kg / 1.116 lb Medida de Cono : Ø16,7 Diametro de Cuerda del Perno : M14X1,5 Diametro del Cuerpo de la Rotu : Ø46,5	5174041AC
	<b>DO11011</b> Buje De Horquilla & Tijera	Chasis (Delantero / Trasero) : Delantero Peso : 0.455 kg / 1.003 lb	52001161, 52002539 52037882, 52037883 52112539, 8952001161 8952001736, 8952002539
	<b>DO11011K</b> Buje De Horquilla & Tijera	Chasis (Delantero / Trasero) : Delantero Peso : 0.91 kg / 2.006 lb Nota : 2 PIECES IN 1 BOX	52001161, 52002539 52037882, 52037883 52112539, 8952001161 8952001736, 8952002539

**RAM 1500**
**III**
**2002 - 2005**





Imagen	Clave del Producto y Descripción	Detalles	OEM
	<b>DO4012</b> Tornillo Estabilizador	Peso : 0,516 kg / 1.138 lb Longitud : 108,1 mm / 4.26 inch Nota : 2WD	05072934AE, 5072934AD 5072934AE, 5086972AB
	<b>DO4015</b> Tornillo Estabilizador	Peso : 0,572 kg / 1.261 lb Longitud : 219,3 mm / 8.63 inch Nota : 4WD	5072935AB, 5072935AC
	<b>DO11010</b> Buje De Horquilla & Tijera	Chasis (Delantero / Trasero) : Delantero Posicion : Superior Peso : 0.221 kg / 0.487 lb	52106580AB, MB00A868430

\* Nombres de los vehículos, marcas, modelos, símbolos y logos, número OE y otros números de terceros en el sitio web y catálogo solo son con fines de referencia.





**RAM 1500 III 2002 - 2005**

Imagen	Clave del Producto y Descripción	Detalles	OEM
	<b>DO11010K</b> Buje De Horquilla & Tijera	Chasis (Delantero / Trasero) : Delantero Posicion : Superior Peso : 0.442 kg / 0.974 lb Nota : YCT13566 X 2	52106580AB, MB00A868430

**RAM 1500 III FACELIFT 2006 - 2008**

Imagen	Clave del Producto y Descripción	Detalles	OEM
	<b>DO1007</b> Rotula	Peso : 0,506 kg / 1.116 lb Medida de Cono : Ø16,7 Diametro de Cuerda del Perno : M14X1,5 Diametro del Cuerpo de la Rotu : Ø46,5	5174041AC
	<b>DO1009</b> Rotula	Peso : 0,663 kg / 1.462 lb	5086672AB, 68214646AA
	<b>DO4012</b> Tornillo Estabilizador	Peso : 0,516 kg / 1.138 lb Longitud : 108,1 mm / 4.26 inch Nota : 2WD	05072934AE, 5072934AD 5072934AE, 5086972AB
	<b>DO4014</b> Tornillo Estabilizador	Peso : 0,546 kg / 1.204 lb Longitud : 160,9 mm / 6.33 inch Nota : 4WD	5170290AB, 5170290AC 5170290AD





**RAM 2500 II 1994 - 2002**

Imagen	Clave del Producto y Descripción	Detalles	OEM
	<b>DO1007</b> Rotula	Peso : 0,506 kg / 1.116 lb Medida de Cono : Ø16,7 Diametro de Cuerda del Perno : M14X1,5 Diametro del Cuerpo de la Rotu : Ø46,5	5174041AC
	<b>DO1010</b> Rotula	Peso : 0,698 kg / 1.539 lb	5015114AA
	<b>DO11011</b> Buje De Horquilla & Tijera	Chasis (Delantero / Trasero) : Delantero Peso : 0.455 kg / 1.003 lb	52001161, 52002539 52037882, 52037883 52112539, 8952001161 8952001736, 8952002539
	<b>DO11011K</b> Buje De Horquilla & Tijera	Chasis (Delantero / Trasero) : Delantero Peso : 0.91 kg / 2.006 lb Nota : 2 PIECES IN 1 BOX	52001161, 52002539 52037882, 52037883 52112539, 8952001161 8952001736, 8952002539

\* Nombres de los vehiculos, marcas, modelos, simbolos y logos, numero OE y otros numeros de terceros en el sitio web y catalogo solo son con fines de referencia.



**RAM 2500**
**III**
**2003 - 2008**

Imagen	Clave del Producto y Descripción	Detalles	OEM
	<b>DO1007</b> Rotula	Peso : 0,506 kg / 1.116 lb Medida de Cono : Ø16,7 Diámetro de Cuerda del Perno : M14X1,5 Diámetro del Cuerpo de la Rotu : Ø46,5	5174041AC
	<b>DO1009</b> Rotula	Peso : 0,663 kg / 1.462 lb	5086672AB, 68214646AA
	<b>DO4012</b> Tornillo Estabilizador	Peso : 0,516 kg / 1.138 lb Longitud : 108,1 mm / 4.26 inch Nota : 2WD	05072934AE, 5072934AD 5072934AE, 5086972AB
	<b>DO4013</b> Tornillo Estabilizador	Peso : 0,360 kg / 0.794 lb Longitud : 155 mm / 6.10 inch Nota : 4WD	5093111AA

**RAM 2500**
**III FACELIFT**
**2008 - 2010**

Imagen	Clave del Producto y Descripción	Detalles	OEM
	<b>DO1007</b> Rotula	Peso : 0,506 kg / 1.116 lb Medida de Cono : Ø16,7 Diámetro de Cuerda del Perno : M14X1,5 Diámetro del Cuerpo de la Rotu : Ø46,5	5174041AC

**RAM 3500**
**II**
**1994 - 2002**



Imagen	Clave del Producto y Descripción	Detalles	OEM
	<b>DO1007</b> Rotula	Peso : 0,506 kg / 1.116 lb Medida de Cono : Ø16,7 Diámetro de Cuerda del Perno : M14X1,5 Diámetro del Cuerpo de la Rotu : Ø46,5	5174041AC
	<b>DO1010</b> Rotula	Peso : 0,698 kg / 1.539 lb	5015114AA
	<b>DO11011</b> Buje De Horquilla & Tijera	Chasis (Delantero / Trasero) : Delantero Peso : 0.455 kg / 1.003 lb	52001161, 52002539 52037882, 52037883 52112539, 8952001161 8952001736, 8952002539
	<b>DO11011K</b> Buje De Horquilla & Tijera	Chasis (Delantero / Trasero) : Delantero Peso : 0.91 kg / 2.006 lb Nota : 2 PIECES IN 1 BOX	52001161, 52002539 52037882, 52037883 52112539, 8952001161 8952001736, 8952002539

\* Nombres de los vehículos, marcas, modelos, símbolos y logos, número OE y otros números de terceros en el sitio web y catálogo solo son con fines de referencia.

**RAM 3500 III 2003 - 2010**

Imagen	Clave del Producto y Descripción	Detalles	OEM
	<b>DO1007</b> Rotula	Peso : 0,506 kg / 1.116 lb Medida de Cono : Ø16,7 Diámetro de Cuerda del Perno : M14X1,5 Diámetro del Cuerpo de la Rotu : Ø46,5	5174041AC
	<b>DO1009</b> Rotula	Peso : 0,663 kg / 1.462 lb	5086672AB, 68214646AA
	<b>DO4012</b> Tornillo Estabilizador	Peso : 0,516 kg / 1.138 lb Longitud : 108,1 mm / 4.26 inch Nota : 2WD	05072934AE, 5072934AD 5072934AE, 5086972AB
	<b>DO4013</b> Tornillo Estabilizador	Peso : 0,360 kg / 0.794 lb Longitud : 155 mm / 6.10 inch Nota : 4WD	5093111AA

**RAM 3500 III FACELIFT 2008 - 2010**

Imagen	Clave del Producto y Descripción	Detalles	OEM
	<b>DO1007</b> Rotula	Peso : 0,506 kg / 1.116 lb Medida de Cono : Ø16,7 Diámetro de Cuerda del Perno : M14X1,5 Diámetro del Cuerpo de la Rotu : Ø46,5	5174041AC
	<b>DO1009</b> Rotula	Peso : 0,663 kg / 1.462 lb	5086672AB, 68214646AA

**SPRINTER 2500 W901, W902, W903 1995 - 2006**

Imagen	Clave del Producto y Descripción	Detalles	OEM
	<b>ME12060</b> Goma De Barra Estabilizadora	Chasis (Delantero / Trasero) : Trasera Peso : 0.1 kg / 0.220 lb Tipo de Material : Rubber	2D0511413, 6013210350
	<b>ME12060K</b> Goma De Barra Estabilizadora	Chasis (Delantero / Trasero) : Trasera Peso : 0.2 kg / 0.441 lb Tipo de Material : Rubber Nota : 2 Pieces	2D0511413, 6013210350

**STRATUS****2001 - 2006**

Imagen	Clave del Producto y Descripción	Detalles	OEM
	<b>MI3025</b> Terminal interior	Peso : 0,624 kg / 1.376 lb Longitud : 316 mm / 12.44 inch Tamaño de la Rosca : M14X1,5 Diámetro de Cuerda del Perno : M14X1,5	MR519046

**RIW<sup>®</sup>**

**EAGLE**

**SUMMIT****1989 - 1992**

Imagen	Clave del Producto y Descripción	Detalles	OEM
	<b>CD4005</b> Tornillo Estabilizador	Peso : 0,220 kg / 0.485 lb Longitud : 145 mm / 5.71 inch	25679063, 3879218

**RIW<sup>®</sup>**

**EDSEL**

**CORSAIR**
**1958 - 1960**

Imagen	Clave del Producto y Descripción	Detalles	OEM
	<b>CD4005</b> Tornillo Estabilizador	Peso : 0,220 kg / 0.485 lb Longitud : 145 mm / 5.71 inch	25679063, 3879218

**RANGER**
**1958 - 1960**

Imagen	Clave del Producto y Descripción	Detalles	OEM
	<b>CD4005</b> Tornillo Estabilizador	Peso : 0,220 kg / 0.485 lb Longitud : 145 mm / 5.71 inch	25679063, 3879218

**VILLAGER**
**1958 - 1960**

Imagen	Clave del Producto y Descripción	Detalles	OEM
	<b>CD4005</b> Tornillo Estabilizador	Peso : 0,220 kg / 0.485 lb Longitud : 145 mm / 5.71 inch	25679063, 3879218

**RIW<sup>®</sup>**

**FIAT**



**500 C**
**2007 -**

Imagen	Clave del Producto y Descripción	Detalles	OEM
	<b>FI6111</b> Horquilla & Tijera	Peso : 3,900 kg / 8.598 lb Tipo de Material : Döküm Çelik	51860383

**500 L**
**2012 - 2020**

Imagen	Clave del Producto y Descripción	Detalles	OEM
	<b>FI13016K</b> Cubre Polvo De Direccion	Peso : 0.164 kg / 0.362 lb	4066.95, 77363828 77364571

**500 X**
**2015 -**

Imagen	Clave del Producto y Descripción	Detalles	OEM
	<b>FI4025A</b> Tornillo Estabilizador	Peso : 0,450 kg / 0.992 lb Tipo de Material : Metal Longitud : 280 mm / 11.02 inch Diámetro de Cuerda del Perno : M12X1,25 Nota : M12x1,25	51939949, 51939949001 52182011, 53403318 53477126, 68246496AA001

**500 X**
**FACELIFT**
**2019 -**

Imagen	Clave del Producto y Descripción	Detalles	OEM
	<b>FI4029</b> Tornillo Estabilizador	Peso : 0,260 kg / 0.573 lb Tipo de Material : Plastico Longitud : 280 mm / 11.02 inch Diámetro de Cuerda del Perno : M12x1,25 Nota : YEARS: FROM 2018 -	68250805AA, 68348850AA

**FI8004 / Kit De Suspensi?n Y Direccion**

**ALBEA**

**178**

**1996 - 2013**



**Piezas del Kit**

Imagen	RIW Codigo / Nombre	OEM	OEM	RIW Codigo / Nombre	Imagen
	<b>FI2023</b> Terminal Exterior Frontal Derecho	46456660, 46745364 98845031	46456189, 46745365 98845032	<b>FI2024</b> Terminal Exterior Frontal Izquierdo	
	<b>FI3017</b> Terminal Interior Delantero	7081851	46539000, 46777741 46794065, 46813841 51712407, 51747323 51764470, 51769073 51866700	<b>FI6079</b> Horquillas Frontal Derecho Inferior	
	<b>FI6080</b> Horquillas Frontal Inferior Izquierdo	46539001, 46777742 46794066, 46813842 51712408, 51747324 51764471, 51769074 51866700			

\* Nombres de los vehiculos, marcas, modelos, simbolos y logos, numero OE y otros numeros de terceros en el sitio web y catalogo solo son con fines de referencia.

**FI8007 / Kit De Suspensi?n Y Direccion**

**BRAVO & BRAVA**

**182**

**1995 - 2002**



**Piezas del Kit**

Imagen	RIW Codigo / Nombre	OEM	OEM	RIW Codigo / Nombre	Imagen
	<b>AF3001</b> Terminal Interior Delantero	9939675, 9941625 9944452, 9947361 9947368	60806355, 7591215 7678717, 9947436 9947438, 99474380 9950672	<b>FI2016</b> Terminal Exterior Frontal Derecho	
	<b>FI2017</b> Terminal Exterior Frontal Izquierdo	60806356, 7591216 7678718, 9947437 9947439, 9950671	12574521, 60570627 7601642, 7601643 7601647	<b>FI4002</b> Tornillo Estabilizador Delantero	
	<b>FI6015</b> Horquillas Frontal Inferior Izquierdo	46423822, 71747915 7777239, 82461081	46423823, 71747916 7777240, 82461082	<b>FI6016</b> Horquillas Frontal Derecho Inferior	

\* Nombres de los vehiculos, marcas, modelos, simbolos y logos, numero OE y otros numeros de terceros en el sitio web y catalogo solo son con fines de referencia.

**OP8002 / Kit De Suspension Y Direccion**
**CROMA**
**194**
**2005 - 2011**

**Piezas del Kit**

Imagen	RIWCodigo / Nombre	OEM	OEM	RIWCodigo / Nombre	Imagen
	<b>OP2017</b> Terminal Exterior Frontal Derecho	1603228, 5235668 5239322, 77363712	12801423, 1603227 5235650, 5239314 77363713	<b>OP2018</b> Terminal Exterior Frontal Izquierdo	
	<b>OP3013</b> Terminal Interior Delantero	1603229, 1603351 1603415, 93172256	24417251, 350603 51741130	<b>OP4007</b> Tornillo Estabilizador Delantero	
	<b>OP6025</b> Horquillas Frontal Derecho Inferior	12796014, 12799200 352052, 51748652	12796013, 12799199 12799200, 352051 51748653	<b>OP6026</b> Horquillas Frontal Inferior Izquierdo	

**CROMA 194 2005 - 2011**

Imagen	Clave del Producto y Descripción	Detalles	OEM
	<b>VX12026</b> Soporte De Motor	Peso : 1,470 kg / 3.241 lb	13112029, 5684143
	<b>OP13005K</b> Cubre Polvo De Direccion	Peso : 0.106 kg / 0.234 lb	1609132, 77363710

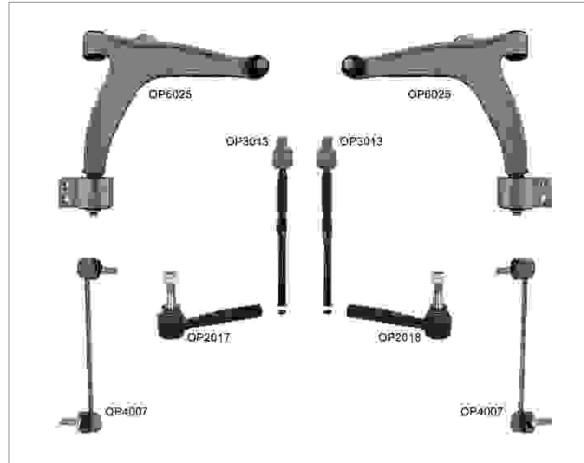
**DOBLO 119 2000 - 2010**

Imagen	Clave del Producto y Descripción	Detalles	OEM
	<b>FI3041</b> Terminal interior	Peso : 0,565 kg / 1.246 lb Longitud : 297,4 mm / 11.71 inch	98845025

**FI8002 / Kit De Suspension Y Direccion**

**DOBLO**

**119**

**2000 - 2010**

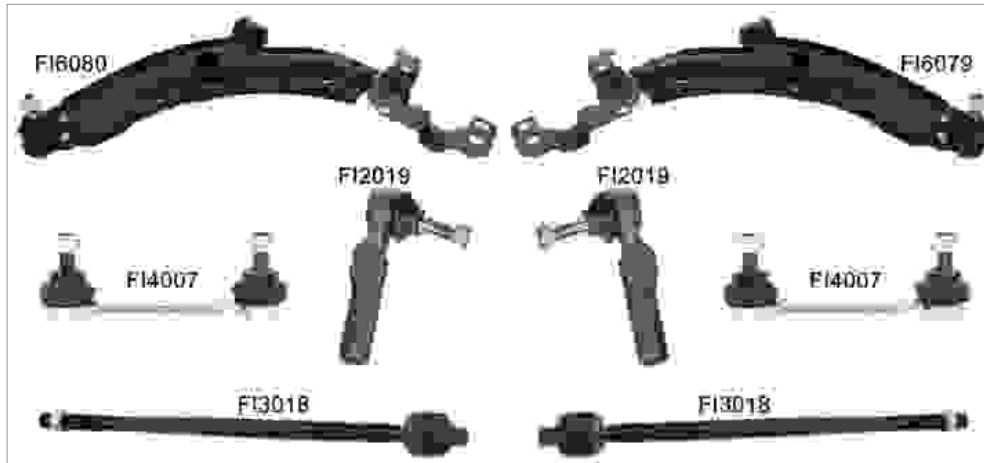

**Piezas del Kit**

Imagen	RIW Codigo / Nombre	OEM	OEM	RIW Codigo / Nombre	Imagen
	<b>FI2019</b> Terminal Exterior Delantero	98845030, 9947714	98845024	<b>FI3018</b> Terminal Interior Delantero	
	<b>FI4007</b> Tornillo Estabilizador Trasera	46767267, 46799278 51717000, 51717001	46539000, 46777741 46794065, 46813841 51712407, 51747323 51764470, 51769073 51866700	<b>FI6079</b> Horquillas Frontal Derecho Inferior	
	<b>FI6080</b> Horquillas Frontal Inferior Izquierdo	46539001, 46777742 46794066, 46813842 51712408, 51747324 51764471, 51769074 51866700			

\* Nombres de los vehiculos, marcas, modelos, simbolos y logos, numero OE y otros numeros de terceros en el sitio web y catalogo solo son con fines de referencia.

**FI8003 / Kit De Suspensi?n Y Direccion**



**DOBLO**

**119**

**2000 - 2010**



**Piezas del Kit**

Imagen	RIW Codigo / Nombre	OEM	OEM	RIW Codigo / Nombre	Imagen
	<b>FI2023</b> Terminal Exterior Frontal Derecho	46456660, 46745364 98845031	46456189, 46745365 98845032	<b>FI2024</b> Terminal Exterior Frontal Izquierdo	
	<b>FI3019</b> Terminal Interior Delantero	98845026	46539000, 46777741 46794065, 46813841 51712407, 51747323 51764470, 51769073 51866700	<b>FI6079</b> Horquillas Frontal Derecho Inferior	
	<b>FI6080</b> Horquillas Frontal Inferior Izquierdo	46539001, 46777742 46794066, 46813842 51712408, 51747324 51764471, 51769074 51866700			

\* Nombres de los vehiculos, marcas, modelos, simbolos y logos, numero OE y otros numeros de terceros en el sitio web y catalogo solo son con fines de referencia.

**FI8004 / Kit De Suspensi?n Y Direccion**



**DOBLO**

**119**

**2000 - 2010**



**Piezas del Kit**

Imagen	RIW Codigo / Nombre	OEM	OEM	RIW Codigo / Nombre	Imagen
	<b>FI2023</b> Terminal Exterior Frontal Derecho	46456660, 46745364 98845031	46456189, 46745365 98845032	<b>FI2024</b> Terminal Exterior Frontal Izquierdo	
	<b>FI3017</b> Terminal Interior Delantero	7081851	46539000, 46777741 46794065, 46813841 51712407, 51747323 51764470, 51769073 51866700	<b>FI6079</b> Horquillas Frontal Derecho Inferior	
	<b>FI6080</b> Horquillas Frontal Inferior Izquierdo	46539001, 46777742 46794066, 46813842 51712408, 51747324 51764471, 51769074 51866700			

\* Nombres de los vehiculos, marcas, modelos, simbolos y logos, numero OE y otros numeros de terceros en el sitio web y catalogo solo son con fines de referencia.



**FI8005 / Kit De Suspensi?n Y Direccion**

**DOBLO**

**152**

**2010 - 2022**



**Piezas del Kit**

Imagen	RIW Codigo / Nombre	OEM	OEM	RIW Codigo / Nombre	Imagen
	<b>FI2045</b> Terminal Exterior Frontal Derecho	1609192, 77365224	1609193, 77365223	<b>FI2046</b> Terminal Exterior Frontal Izquierdo	
	<b>FI3037</b> Terminal Interior Delantero	26144989, 51854419 51854420, 51885794 51885795, 51885796 51885797, 51938732	350198, 51848645 51898527, 95511247	<b>FI4019</b> Tornillo Estabilizador Delantero	
	<b>FI6087</b> Horquillas Frontal Derecho Inferior	51810664	51810665	<b>FI6088</b> Horquillas Frontal Inferior Izquierdo	

\* Nombres de los vehiculos, marcas, modelos, simbolos y logos, numero OE y otros numeros de terceros en el sitio web y catalogo solo son con fines de referencia.

**FI8005 / Kit De Suspensi?n Y Direccion**

**DOBLO**

**MPV 1263**

**2010 - 2022**



**Piezas del Kit**

Imagen	RIW Codigo / Nombre	OEM	OEM	RIW Codigo / Nombre	Imagen
	<b>FI2045</b> Terminal Exterior Frontal Derecho	1609192, 77365224	1609193, 77365223	<b>FI2046</b> Terminal Exterior Frontal Izquierdo	
	<b>FI3037</b> Terminal Interior Delantero	26144989, 51854419 51854420, 51885794 51885795, 51885796 51885797, 51938732	350198, 51848645 51898527, 95511247	<b>FI4019</b> Tornillo Estabilizador Delantero	
	<b>FI6087</b> Horquillas Frontal Derecho Inferior	51810664	51810665	<b>FI6088</b> Horquillas Frontal Inferior Izquierdo	

\* Nombres de los vehiculos, marcas, modelos, simbolos y logos, numero OE y otros numeros de terceros en el sitio web y catalogo solo son con fines de referencia.

**DUCATO III 250 1,5Q - 1,7Q - 1,7H - 2,0Q 2006 -**

Imagen	Clave del Producto y Descripción	Detalles	OEM
	<b>FI12176</b> Soporte De Motor	Chasis (Delantero / Trasero) : Delantero Peso : 1,430 kg / 3.153 lb Tipo de Material : Soporte De Transmision	1344335080, 1854.25

**DUCATO IV 2015 -**

Imagen	Clave del Producto y Descripción	Detalles	OEM
	<b>CI6031</b> Horquilla & Tijera	Peso : 7,054 kg / 15.551 lb Tipo de Material : Döküm Çelik	1374222080, 1612735580
	<b>CI6032</b> Horquilla & Tijera	Peso : 7,054 kg / 15.551 lb Tipo de Material : Döküm Çelik	1374223080, 1612735680

**FI8010 / Kit De Suspensi?n Y Direccion**

**EGEA**

**ESTATE 357**

**2016 -**



**Piezas del Kit**

Imagen	RIW Codigo / Nombre	OEM	OEM	RIW Codigo / Nombre	Imagen
	<b>FI2050</b> Terminal Exterior Delantero	68326097AA, 77367379	52014014	<b>FI3039</b> Terminal Interior Delantero	
	<b>FI4025</b> Tornillo Estabilizador Delantero	51939949, 51939949001 52182011, 53403318 53477126, 68246496AA001	52011612	<b>FI6105</b> Horquillas Frontal Derecho Inferior	
	<b>FI6106</b> Horquillas Frontal Inferior Izquierdo	52011614			

\* Nombres de los vehiculos, marcas, modelos, simbolos y logos, numero OE y otros numeros de terceros en el sitio web y catalogo solo son con fines de referencia.

**EGEA** **ESTATE 357** **2016 -**

Imagen	Clave del Producto y Descripción	Detalles	OEM
	<p><b>FI4025A</b> Tornillo Estabilizador</p>	<p>Peso : 0,450 kg / 0.992 lb Tipo de Material : Metal Longitud : 280 mm / 11.02 inch Diámetro de Cuerda del Perno : M12X1,25 Nota : M12x1,25</p>	<p>51939949, 51939949001 52182011, 53403318 53477126, 68246496AA001</p>

\* Nombres de los vehículos, marcas, modelos, símbolos y logos, número OE y otros números de terceros en el sitio web y catálogo solo son con fines de referencia.

**FI8010 / Kit De Suspensi?n Y Direccion**

**EGEA**

**HATCHBACK 357**

**2016 -**



**Piezas del Kit**

Imagen	RIW Codigo / Nombre	OEM	OEM	RIW Codigo / Nombre	Imagen
	<b>FI2050</b> Terminal Exterior Delantero	68326097AA, 77367379	52014014	<b>FI3039</b> Terminal Interior Delantero	
	<b>FI4025</b> Tornillo Estabilizador Delantero	51939949, 51939949001 52182011, 53403318 53477126, 68246496AA001	52011612	<b>FI6105</b> Horquillas Frontal Derecho Inferior	
	<b>FI6106</b> Horquillas Frontal Inferior Izquierdo	52011614			

\* Nombres de los vehiculos, marcas, modelos, simbolos y logos, numero OE y otros numeros de terceros en el sitio web y catalogo solo son con fines de referencia.

**EGEA HATCHBACK 357 2016 -**

Imagen	Clave del Producto y Descripción	Detalles	OEM
	<p><b>FI4025A</b> Tornillo Estabilizador</p>	<p>Peso : 0,450 kg / 0.992 lb                      Tipo de Material : Metal                      Longitud : 280 mm / 11.02 inch                      Diametro de Cuerda del Perno : M12X1,25                      Nota : M12x1,25</p>	<p>51939949, 51939949001                      52182011, 53403318                      53477126, 68246496AA001</p>

\* Nombres de los vehiculos, marcas, modelos, simbolos y logos, numero OE y otros numeros de terceros en el sitio web y catalogo solo son con fines de referencia.

**FI8010 / Kit De Suspensi?n Y Direccion**

**EGEA**

**SALOON 356**

**2015 -**



**Piezas del Kit**

Imagen	RIW Codigo / Nombre	OEM	OEM	RIW Codigo / Nombre	Imagen
	<b>FI2050</b> Terminal Exterior Delantero	68326097AA, 77367379	52014014	<b>FI3039</b> Terminal Interior Delantero	
	<b>FI4025</b> Tornillo Estabilizador Delantero	51939949, 51939949001 52182011, 53403318 53477126, 68246496AA001	52011612	<b>FI6105</b> Horquillas Frontal Derecho Inferior	
	<b>FI6106</b> Horquillas Frontal Inferior Izquierdo	52011614			

\* Nombres de los vehiculos, marcas, modelos, simbolos y logos, numero OE y otros numeros de terceros en el sitio web y catalogo solo son con fines de referencia.



**EGEA SALOON 356 2015 -**

Imagen	Clave del Producto y Descripción	Detalles	OEM
	<p><b>FI4025A</b> Tornillo Estabilizador</p>	<p>Peso : 0,450 kg / 0.992 lb                      Tipo de Material : Metal                      Longitud : 280 mm / 11.02 inch                      Diametro de Cuerda del Perno : M12X1,25                      Nota : M12x1,25</p>	<p>51939949, 51939949001                      52182011, 53403318                      53477126, 68246496AA001</p>





\* Nombres de los vehiculos, marcas, modelos, simbolos y logos, numero OE y otros numeros de terceros en el sitio web y catalogo solo son con fines de referencia.

**FI8006 / Kit De Suspensi?n Y Direccion**
**FIORINO**
**2008 -**

**Piezas del Kit**

Imagen	RIW Codigo / Nombre	OEM	OEM	RIW Codigo / Nombre	Imagen
	<b>CI3012</b> Terminal Interior Delantero	1608899780, 1630726680 1630726780, 1630726880 1630726980, 1663659480 1663659680, 1663659780 4001.77, 4001.CW	3817.87, 381787 77364569	<b>FI2042</b> Terminal Exterior Frontal Derecho	
	<b>FI2043</b> Terminal Exterior Frontal Izquierdo	3817.86, 381786 77364568	5087.65, 5087.70 5087.79, 508765 508770, 51704008 51815479, 51815480	<b>FI4013</b> Tornillo Estabilizador Delantero	
	<b>FI6059</b> Horquillas Frontal Inferior Izquierdo	3520.W3, 3520.Y4 3520W3, 51783057 51839040, 51895367 5352039, 55703230 55703629	3521.S6, 3521.V5 50511650, 51783056 51839039, 51895366 5352038, 55703231 55703627	<b>FI6060</b> Horquillas Frontal Derecho Inferior	

**FIORINO**
**2008 -**

Imagen	Clave del Producto y Descripción	Detalles	OEM
	<b>FI12014A</b> Soporte De Amortiguador	Chasis (Delantero / Trasero) : Delantero Posicion : Derecha Otro Lado del Artículo : FI12015A Peso : 0.86 kg / 1.896 lb Nota : AMORTISÖR TAKOZU YENİ TİP	5038.G7, 5038.J8 51804748, 51839931 51855157, 52023099 52109286
	<b>FI12015A</b> Soporte De Amortiguador	Chasis (Delantero / Trasero) : Delantero Posicion : Izquierdo Otro Lado del Artículo : FI12014A Peso : 0.86 kg / 1.896 lb Nota : AMORTISÖR TAKOZU YENİ TİP	5038.G8, 5038.J7 51804747, 51839975 51855158, 51928747 52023097
	<b>FI12804</b> Soporte De Amortiguador	Chasis (Delantero / Trasero) : Delantero Posicion : Derecho-Izquierdo Peso : 1.68 kg / 3.704 lb Nota : KIT = FI12014 FI12015	5038.G7, 5038.G8 5038.J7, 5038.J8 51804747, 51804748 51839931, 51839975 51855157, 51855158
	<b>FI12804A</b> Soporte De Amortiguador	Chasis (Delantero / Trasero) : Delantero Posicion : Derecho-Izquierdo Peso : 1.68 kg / 3.704 lb Nota : KIT = FI12014A FI12015A	5038.G7, 5038.G8 5038.J7, 5038.J8 51804747, 51804748 51839931, 51839975 51855157, 51855158
	<b>FI13016K</b> Cubre Polvo De Direccion	Peso : 0.164 kg / 0.362 lb	4066.95, 77363828 77364571

**GRANDE PUNTO**
**199**
**2005 - 2012**





Imagen	Clave del Producto y Descripción	Detalles	OEM
	<b>FI13016K</b> Cubre Polvo De Direccion	Peso : 0.164 kg / 0.362 lb	4066.95, 77363828 77364571

**FI8006 / Kit De Suspensi?n Y Direccion**
**LINEA**
**323**
**2007 - 2016**

**Piezas del Kit**

Imagen	RIW Codigo / Nombre	OEM	OEM	RIW Codigo / Nombre	Imagen
	<b>CI3012</b> Terminal Interior Delantero	1608899780, 1630726680 1630726780, 1630726880 1630726980, 1663659480 1663659680, 1663659780 4001.77, 4001.CW	3817.87, 381787 77364569	<b>FI2042</b> Terminal Exterior Frontal Derecho	
	<b>FI2043</b> Terminal Exterior Frontal Izquierdo	3817.86, 381786 77364568	5087.65, 5087.70 5087.79, 508765 508770, 51704008 51815479, 51815480	<b>FI4013</b> Tornillo Estabilizador Delantero	
	<b>FI6059</b> Horquillas Frontal Inferior Izquierdo	3520.W3, 3520.Y4 3520W3, 51783057 51839040, 51895367 5352039, 55703230 55703629	3521.S6, 3521.V5 50511650, 51783056 51839039, 51895366 5352038, 55703231 55703627	<b>FI6060</b> Horquillas Frontal Derecho Inferior	

**LINEA 323 2007 - 2016**

Imagen	Clave del Producto y Descripción	Detalles	OEM
	<b>FI12014A</b> Soporte De Amortiguador	Chasis (Delantero / Trasero) : Delantero Posicion : Derecha Otro Lado del Artículo : FI12015A Peso : 0.86 kg / 1.896 lb Nota : AMORTISÖR TAKOZU YENİ TİP	5038.G7, 5038.J8 51804748, 51839931 51855157, 52023099 52109286
	<b>FI12015A</b> Soporte De Amortiguador	Chasis (Delantero / Trasero) : Delantero Posicion : Izquierdo Otro Lado del Artículo : FI12014A Peso : 0.86 kg / 1.896 lb Nota : AMORTISÖR TAKOZU YENİ TİP	5038.G8, 5038.J7 51804747, 51839975 51855158, 51928747 52023097
	<b>FI12804</b> Soporte De Amortiguador	Chasis (Delantero / Trasero) : Delantero Posicion : Derecho-Izquierdo Peso : 1.68 kg / 3.704 lb Nota : KIT = FI12014 FI12015	5038.G7, 5038.G8 5038.J7, 5038.J8 51804747, 51804748 51839931, 51839975 51855157, 51855158
	<b>FI12804A</b> Soporte De Amortiguador	Chasis (Delantero / Trasero) : Delantero Posicion : Derecho-Izquierdo Peso : 1.68 kg / 3.704 lb Nota : KIT = FI12014A FI12015A	5038.G7, 5038.G8 5038.J7, 5038.J8 51804747, 51804748 51839931, 51839975 51855157, 51855158
	<b>FI13016K</b> Cubre Polvo De Direccion	Peso : 0.164 kg / 0.362 lb	4066.95, 77363828 77364571

**FI8004 / Kit De Suspensi?n Y Direccion**



**PALIO**

**178BX - DX-277**

**1996 - 2013**



**Piezas del Kit**

Imagen	RIW Codigo / Nombre	OEM	OEM	RIW Codigo / Nombre	Imagen
	<b>FI2023</b> Terminal Exterior Frontal Derecho	46456660, 46745364 98845031	46456189, 46745365 98845032	<b>FI2024</b> Terminal Exterior Frontal Izquierdo	
	<b>FI3017</b> Terminal Interior Delantero	7081851	46539000, 46777741 46794065, 46813841 51712407, 51747323 51764470, 51769073 51866700	<b>FI6079</b> Horquillas Frontal Derecho Inferior	
	<b>FI6080</b> Horquillas Frontal Inferior Izquierdo	46539001, 46777742 46794066, 46813842 51712408, 51747324 51764471, 51769074 51866700			

\* Nombres de los vehiculos, marcas, modelos, simbolos y logos, numero OE y otros numeros de terceros en el sitio web y catalogo solo son con fines de referencia.

**FI8009 / Kit De Suspensi?n Y Direccion**

**PANDA**

**169**

**2003 - 2012**



**Piezas del Kit**

Imagen	RIWCodigo / Nombre	OEM	OEM	RIWCodigo / Nombre	Imagen
	<b>FI2014</b> Terminal Exterior Frontal Derecho	1543821, 1546260 77362508, 9S513270BA	1543820, 1546259 77362507, 9S513270AA	<b>FI2015</b> Terminal Exterior Frontal Izquierdo	
	<b>FI3006</b> Terminal Interior Delantero	77362506	50703296	<b>FI4001</b> Tornillo Estabilizador Delantero	
	<b>FI6063</b> Horquillas Frontal Derecho Inferior	50703129, 51857134	50703128, 51857133	<b>FI6064</b> Horquillas Frontal Inferior Izquierdo	

\* Nombres de los vehiculos, marcas, modelos, simbolos y logotipos, numero OE y otros numeros de terceros en el sitio web y catalogo solo son con fines de referencia.

**PUNTO EVO**

**2008 - 2012**

Imagen	Clave del Producto y Descripción	Detalles	OEM
	<p><b>F113016K</b> Cubre Polvo De Direccion</p>	<p>Peso : 0.164 kg / 0.362 lb</p>	<p>4066.95, 77363828 77364571</p>

\* Nombres de los vehiculos, marcas, modelos, simbolos y logos, numero OE y otros numeros de terceros en el sitio web y catalogo solo son con fines de referencia.







**FI8006 / Kit De Suspensi?n Y Direccion**
**QUBO**
**225**
**2008 -**

**Piezas del Kit**

Imagen	RIW Codigo / Nombre	OEM	OEM	RIW Codigo / Nombre	Imagen
	<b>CI3012</b> Terminal Interior Delantero	1608899780, 1630726680 1630726780, 1630726880 1630726980, 1663659480 1663659680, 1663659780 4001.77, 4001.CW	3817.87, 381787 77364569	<b>FI2042</b> Terminal Exterior Frontal Derecho	
	<b>FI2043</b> Terminal Exterior Frontal Izquierdo	3817.86, 381786 77364568	5087.65, 5087.70 5087.79, 508765 508770, 51704008 51815479, 51815480	<b>FI4013</b> Tornillo Estabilizador Delantero	
	<b>FI6059</b> Horquillas Frontal Inferior Izquierdo	3520.W3, 3520.Y4 3520W3, 51783057 51839040, 51895367 5352039, 55703230 55703629	3521.S6, 3521.V5 50511650, 51783056 51839039, 51895366 5352038, 55703231 55703627	<b>FI6060</b> Horquillas Frontal Derecho Inferior	

**QUBO**
**225**
**2008 -**

Imagen	Clave del Producto y Descripción	Detalles	OEM
	<b>FI12014A</b> Soporte De Amortiguador	Chasis (Delantero / Trasero) : Delantero Posicion : Derecha Otro Lado del Artículo : FI12015A Peso : 0.86 kg / 1.896 lb Nota : AMORTISÖR TAKOZU YENİ TİP	5038.G7, 5038.J8 51804748, 51839931 51855157, 52023099 52109286
	<b>FI12015A</b> Soporte De Amortiguador	Chasis (Delantero / Trasero) : Delantero Posicion : Izquierdo Otro Lado del Artículo : FI12014A Peso : 0.86 kg / 1.896 lb Nota : AMORTISÖR TAKOZU YENİ TİP	5038.G8, 5038.J7 51804747, 51839975 51855158, 51928747 52023097
	<b>FI12804</b> Soporte De Amortiguador	Chasis (Delantero / Trasero) : Delantero Posicion : Derecho-Izquierdo Peso : 1.68 kg / 3.704 lb Nota : KIT = FI12014 FI12015	5038.G7, 5038.G8 5038.J7, 5038.J8 51804747, 51804748 51839931, 51839975 51855157, 51855158
	<b>FI12804A</b> Soporte De Amortiguador	Chasis (Delantero / Trasero) : Delantero Posicion : Derecho-Izquierdo Peso : 1.68 kg / 3.704 lb Nota : KIT = FI12014A FI12015A	5038.G7, 5038.G8 5038.J7, 5038.J8 51804747, 51804748 51839931, 51839975 51855157, 51855158
	<b>FI13016K</b> Cubre Polvo De Direccion	Peso : 0.164 kg / 0.362 lb	4066.95, 77363828 77364571

**SEDICI**
**2006 - 2014**

Imagen	Clave del Producto y Descripción	Detalles	OEM
	<b>FI11062</b> Buje De Horquilla & Tijera	Chasis (Delantero / Trasero) : Delantero Posicion : Inferior Peso : 0.186 kg / 0.410 lb	45261-79J00, 71742733
	<b>FI11063</b> Buje De Horquilla & Tijera	Chasis (Delantero / Trasero) : Delantero Posicion : Inferior Peso : 0.12 kg / 0.265 lb	Part of 71742731, Part of 71742732

**FI8004 / Kit De Suspensi?n Y Direccion**

**SIENA**

**172, 178**

**1996 - 2013**



**Piezas del Kit**

Imagen	RIW Codigo / Nombre	OEM	OEM	RIW Codigo / Nombre	Imagen
	<b>FI2023</b> Terminal Exterior Frontal Derecho	46456660, 46745364 98845031	46456189, 46745365 98845032	<b>FI2024</b> Terminal Exterior Frontal Izquierdo	
	<b>FI3017</b> Terminal Interior Delantero	7081851	46539000, 46777741 46794065, 46813841 51712407, 51747323 51764470, 51769073 51866700	<b>FI6079</b> Horquillas Frontal Derecho Inferior	
	<b>FI6080</b> Horquillas Frontal Inferior Izquierdo	46539001, 46777742 46794066, 46813842 51712408, 51747324 51764471, 51769074 51866700			

\* Nombres de los vehiculos, marcas, modelos, simbolos y logos, numero OE y otros numeros de terceros en el sitio web y catalogo solo son con fines de referencia.

**FI8004 / Kit De Suspensi?n Y Direccion**
**STRADA**
**278**
**1999 - 2020**

**Piezas del Kit**

Imagen	RIW Codigo / Nombre	OEM	OEM	RIW Codigo / Nombre	Imagen
	<b>FI2023</b> Terminal Exterior Frontal Derecho	46456660, 46745364 98845031	46456189, 46745365 98845032	<b>FI2024</b> Terminal Exterior Frontal Izquierdo	
	<b>FI3017</b> Terminal Interior Delantero	7081851	46539000, 46777741 46794065, 46813841 51712407, 51747323 51764470, 51769073 51866700	<b>FI6079</b> Horquillas Frontal Derecho Inferior	
	<b>FI6080</b> Horquillas Frontal Inferior Izquierdo	46539001, 46777742 46794066, 46813842 51712408, 51747324 51764471, 51769074 51866700			

**FI8007 / Kit De Suspensi?n Y Direccion**

**TEMPRA**

**1988 - 1997**



**Piezas del Kit**

Imagen	RIW Codigo / Nombre	OEM	OEM	RIW Codigo / Nombre	Imagen
	<b>AF3001</b> Terminal Interior Delantero	9939675, 9941625 9944452, 9947361 9947368	60806355, 7591215 7678717, 9947436 9947438, 99474380 9950672	<b>FI2016</b> Terminal Exterior Frontal Derecho	
	<b>FI2017</b> Terminal Exterior Frontal Izquierdo	60806356, 7591216 7678718, 9947437 9947439, 9950671	12574521, 60570627 7601642, 7601643 7601647	<b>FI4002</b> Tornillo Estabilizador Delantero	
	<b>FI6015</b> Horquillas Frontal Inferior Izquierdo	46423822, 71747915 7777239, 82461081	46423823, 71747916 7777240, 82461082	<b>FI6016</b> Horquillas Frontal Derecho Inferior	

\* Nombres de los vehiculos, marcas, modelos, simbolos y logos, numero OE y otros numeros de terceros en el sitio web y catalogo solo son con fines de referencia.

**FI8007 / Kit De Suspensi?n Y Direccion**

**TIPO**

**1987 - 2000**



**Piezas del Kit**

Imagen	RIW Codigo / Nombre	OEM	OEM	RIW Codigo / Nombre	Imagen
	<b>AF3001</b> Terminal Interior Delantero	9939675, 9941625 9944452, 9947361 9947368	60806355, 7591215 7678717, 9947436 9947438, 99474380 9950672	<b>FI2016</b> Terminal Exterior Frontal Derecho	
	<b>FI2017</b> Terminal Exterior Frontal Izquierdo	60806356, 7591216 7678718, 9947437 9947439, 9950671	12574521, 60570627 7601642, 7601643 7601647	<b>FI4002</b> Tornillo Estabilizador Delantero	
	<b>FI6015</b> Horquillas Frontal Inferior Izquierdo	46423822, 71747915 7777239, 82461081	46423823, 71747916 7777240, 82461082	<b>FI6016</b> Horquillas Frontal Derecho Inferior	

\* Nombres de los vehiculos, marcas, modelos, simbolos y logos, numero OE y otros numeros de terceros en el sitio web y catalogo solo son con fines de referencia.

**FI8010 / Kit De Suspensi?n Y Direccion**

**TIPO**

**2016 -**



**Piezas del Kit**

Imagen	RIW Codigo / Nombre	OEM	OEM	RIW Codigo / Nombre	Imagen
	<b>FI2050</b> Terminal Exterior Delantero	68326097AA, 77367379	52014014	<b>FI3039</b> Terminal Interior Delantero	
	<b>FI4025</b> Tornillo Estabilizador Delantero	51939949, 51939949001 52182011, 53403318 53477126, 68246496AA001	52011612	<b>FI6105</b> Horquillas Frontal Derecho Inferior	
	<b>FI6106</b> Horquillas Frontal Inferior Izquierdo	52011614			

\* Nombres de los vehiculos, marcas, modelos, simbolos y logos, numero OE y otros numeros de terceros en el sitio web y catalogo solo son con fines de referencia.

**TIPO**

**2016 -**

Imagen	Clave del Producto y Descripción	Detalles	OEM
	<p><b>FI4025A</b> Tornillo Estabilizador</p>	<p>Peso : 0,450 kg / 0.992 lb Tipo de Material : Metal Longitud : 280 mm / 11.02 inch Diámetro de Cuerda del Perno : M12X1,25 Nota : M12x1,25</p>	<p>51939949, 51939949001 52182011, 53403318 53477126, 68246496AA001</p>

\* Nombres de los vehículos, marcas, modelos, símbolos y logos, número OE y otros números de terceros en el sitio web y catálogo solo son con fines de referencia.



**FI8008 / Kit De Suspensi?n Y Direccion**

**UNO**

**146A-E**

**1983 - 2001**

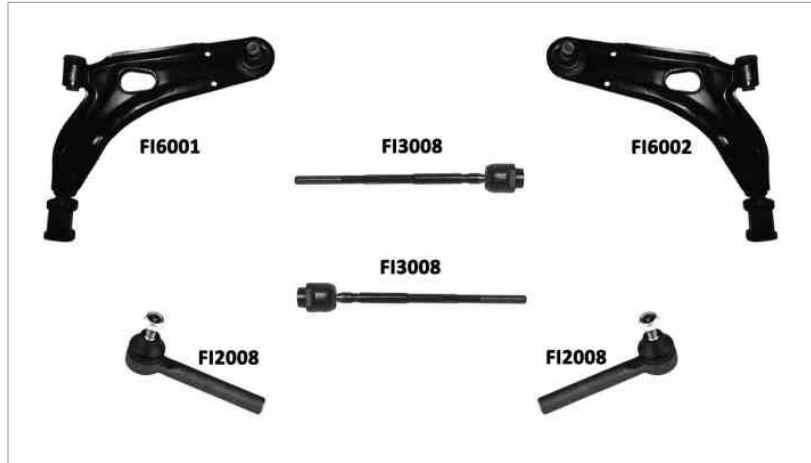

**Piezas del Kit**

Imagen	RIW Codigo / Nombre	OEM	OEM	RIW Codigo / Nombre	Imagen
	<b>FI2008</b> Terminal Exterior Delantero	5958246, 5958247 5958264, 5983404 5983406, 7560331	022162449A, 4410145 5958244, 7633721 SE022162449A, SE022162449S	<b>FI3008</b> Terminal Interior Delantero	
	<b>FI6001</b> Horquillas Frontal Derecho Inferior	5939685, 7705616	5939683, 7705615	<b>FI6002</b> Horquillas Frontal Inferior Izquierdo	

\* Nombres de los vehiculos, marcas, modelos, simbolos y logos, numero OE y otros numeros de terceros en el sitio web y catalogo solo son con fines de referencia.

**RIW<sup>®</sup>**

**FORD**

**AEROSTAR**
**1986 - 1997**

Imagen	Clave del Producto y Descripción	Detalles	OEM
	<b>FO3052</b> Terminal interior	Peso : 0,583 kg / 1.285 lb Longitud : 338 mm / 13.31 inch	E6DZ3280A, F6SZ3280BA
	<b>CD4005</b> Tornillo Estabilizador	Peso : 0,220 kg / 0.485 lb Longitud : 145 mm / 5.71 inch	25679063, 3879218

**B-MAX**
**JK**
**2012 - 2017**

Imagen	Clave del Producto y Descripción	Detalles	OEM
	<b>FI13016K</b> Cubre Polvo De Direccion	Peso : 0.164 kg / 0.362 lb	4066.95, 77363828 77364571

**C-MAX**
**DXA**
**2010 - 2019**

Imagen	Clave del Producto y Descripción	Detalles	OEM
	<b>FO12064</b> Soporte De Motor	Peso : 2.026 kg / 4.467 lb	1872079, 2111961 F1F16F012AA, F1F16F012BB

**COUNTRY SQUIRE**
**1987 - 1991**

Imagen	Clave del Producto y Descripción	Detalles	OEM
	<b>FO2077</b> TERMINAL EXTERIOR FRONTAL EXTERIOR	Peso : 0,450 kg / 0.992 lb Longitud : 71,1 mm / 2.80 inch	2W7Z3A130A, 2W7Z3A130AA D9AZ3A130A, F3AZ3A130A F5AZ3A130A
	<b>FO2089</b> Terminal Exterior	Peso : 0,561 kg / 1.237 lb Longitud : 165 mm / 6.50 inch	2W7Z3A131A, 2W7Z3A131AA D9AZ3A131A, F5AZ3A131A
	<b>CV4056</b> Tornillo Estabilizador	Peso : 0,182 kg / 0.401 lb Longitud : 195,5 mm / 7.70 inch	25784241

**CROWN VICTORIA**
**1992 - 1994**

Imagen	Clave del Producto y Descripción	Detalles	OEM
	<b>FO2077</b> TERMINAL EXTERIOR FRONTAL EXTERIOR	Peso : 0,450 kg / 0.992 lb Longitud : 71,1 mm / 2.80 inch	2W7Z3A130A, 2W7Z3A130AA D9AZ3A130A, F3AZ3A130A F5AZ3A130A
	<b>FO2089</b> Terminal Exterior	Peso : 0,561 kg / 1.237 lb Longitud : 165 mm / 6.50 inch	2W7Z3A131A, 2W7Z3A131AA D9AZ3A131A, F5AZ3A131A

**CROWN VICTORIA**
**1995 - 1997**

Imagen	Clave del Producto y Descripción	Detalles	OEM
	<b>FO2077</b> TERMINAL EXTERIOR FRONTAL EXTERIOR	Peso : 0,450 kg / 0.992 lb Longitud : 71,1 mm / 2.80 inch	2W7Z3A130A, 2W7Z3A130AA D9AZ3A130A, F3AZ3A130A F5AZ3A130A
	<b>FO2089</b> Terminal Exterior	Peso : 0,561 kg / 1.237 lb Longitud : 165 mm / 6.50 inch	2W7Z3A131A, 2W7Z3A131AA D9AZ3A131A, F5AZ3A131A

**CROWN VICTORIA**
**1998 - 2002**

Imagen	Clave del Producto y Descripción	Detalles	OEM
	<b>FO2077</b> TERMINAL EXTERIOR FRONTAL EXTERIOR	Peso : 0,450 kg / 0.992 lb Longitud : 71,1 mm / 2.80 inch	2W7Z3A130A, 2W7Z3A130AA D9AZ3A130A, F3AZ3A130A F5AZ3A130A
	<b>FO2089</b> Terminal Exterior	Peso : 0,561 kg / 1.237 lb Longitud : 165 mm / 6.50 inch	2W7Z3A131A, 2W7Z3A131AA D9AZ3A131A, F5AZ3A131A
	<b>FO4077</b> Tornillo Estabilizador	Peso : 0,401 kg / 0.884 lb Tipo de Material : Metal Longitud : 160 mm / 6.30 inch	F5AZ5K484A, F5AZ6K484AA F8AZ5K484AA

**E-150**
**IV-IV**
**2008 - 2014**

Imagen	Clave del Producto y Descripción	Detalles	OEM
	<b>FO1055</b> Rotula	Peso : 0,886 kg / 1.953 lb	5C2Z3050BA, 8C2Z3050A XC2Z3050AA, YC2Z3050BA

\* Nombres de los vehículos, marcas, modelos, símbolos y logos, número OE y otros números de terceros en el sitio web y catálogo solo son con fines de referencia.

**E-150 IV-IV 2008 - 2014**

Imagen	Clave del Producto y Descripción	Detalles	OEM
	<b>FO2087</b> Terminal Exterior	Peso : 0,810 kg / 1.786 lb Longitud : 145,5 mm / 5.73 inch	6C2Z3A131B, 8C2Z3A131D
	<b>FO2088</b> Terminal Exterior	Peso : 0,810 kg / 1.786 lb Longitud : 145,5 mm / 5.73 inch	6C2Z3A131C, 8C2Z3A131C

**E-250 IV-IV 2008 - 2014**

Imagen	Clave del Producto y Descripción	Detalles	OEM
	<b>FO1055</b> Rotula	Peso : 0,886 kg / 1.953 lb	5C2Z3050BA, 8C2Z3050A XC2Z3050AA, YC2Z3050BA
	<b>FO2087</b> Terminal Exterior	Peso : 0,810 kg / 1.786 lb Longitud : 145,5 mm / 5.73 inch	6C2Z3A131B, 8C2Z3A131D
	<b>FO2088</b> Terminal Exterior	Peso : 0,810 kg / 1.786 lb Longitud : 145,5 mm / 5.73 inch	6C2Z3A131C, 8C2Z3A131C

**E-350 IV-IV 2008 - 2014**

Imagen	Clave del Producto y Descripción	Detalles	OEM
	<b>FO1055</b> Rotula	Peso : 0,886 kg / 1.953 lb	5C2Z3050BA, 8C2Z3050A XC2Z3050AA, YC2Z3050BA
	<b>FO2087</b> Terminal Exterior	Peso : 0,810 kg / 1.786 lb Longitud : 145,5 mm / 5.73 inch	6C2Z3A131B, 8C2Z3A131D
	<b>FO2088</b> Terminal Exterior	Peso : 0,810 kg / 1.786 lb Longitud : 145,5 mm / 5.73 inch	6C2Z3A131C, 8C2Z3A131C

**E-350 IV-V 2015 - 2020**

Imagen	Clave del Producto y Descripción	Detalles	OEM
	<b>FO1055</b> Rotula	Peso : 0,886 kg / 1.953 lb	5C2Z3050BA, 8C2Z3050A XC2Z3050AA, YC2Z3050BA
	<b>FO2087</b> Terminal Exterior	Peso : 0,810 kg / 1.786 lb Longitud : 145,5 mm / 5.73 inch	6C2Z3A131B, 8C2Z3A131D
	<b>FO2088</b> Terminal Exterior	Peso : 0,810 kg / 1.786 lb Longitud : 145,5 mm / 5.73 inch	6C2Z3A131C, 8C2Z3A131C

**E-450 IV-IV 2008 - 2014**

Imagen	Clave del Producto y Descripción	Detalles	OEM
	<b>FO1055</b> Rotula	Peso : 0,886 kg / 1.953 lb	5C2Z3050BA, 8C2Z3050A XC2Z3050AA, YC2Z3050BA
	<b>FO2087</b> Terminal Exterior	Peso : 0,810 kg / 1.786 lb Longitud : 145,5 mm / 5.73 inch	6C2Z3A131B, 8C2Z3A131D
	<b>FO2088</b> Terminal Exterior	Peso : 0,810 kg / 1.786 lb Longitud : 145,5 mm / 5.73 inch	6C2Z3A131C, 8C2Z3A131C

**E-450 IV-V 2015 - 2020**

Imagen	Clave del Producto y Descripción	Detalles	OEM
	<b>FO1055</b> Rotula	Peso : 0,886 kg / 1.953 lb	5C2Z3050BA, 8C2Z3050A XC2Z3050AA, YC2Z3050BA
	<b>FO2087</b> Terminal Exterior	Peso : 0,810 kg / 1.786 lb Longitud : 145,5 mm / 5.73 inch	6C2Z3A131B, 8C2Z3A131D
	<b>FO2088</b> Terminal Exterior	Peso : 0,810 kg / 1.786 lb Longitud : 145,5 mm / 5.73 inch	6C2Z3A131C, 8C2Z3A131C

\* Nombres de los vehículos, marcas, modelos, símbolos y logos, número OE y otros números de terceros en el sitio web y catálogo solo son con fines de referencia.

**EDGE II 2015 - 2024**

Imagen	Clave del Producto y Descripción	Detalles	OEM
	<b>FO9030</b> Horquilla & Tijera	Peso : 1,049 kg / 2.313 lb Tipo de Material : Chapa Metálica	E1GZ5K898A, FR3Z5K898A FR3Z5K898B, G3GZ5K898A

**EXCURSION 2000 - 2005**

Imagen	Clave del Producto y Descripción	Detalles	OEM
	<b>FO1054</b> Rotula	Peso : 0,740 kg / 1.631 lb Medida de Cono : Ø22,5 Diámetro de Cuerda del Perno : 3/4-16 UNF Diámetro del Cuerpo de la Rotu : Ø50,2	5C3Z3050D, 5C3Z3050DA 8C3Z3050D, 8C3Z3050DA E7TZ3050B, F6TZ3050AB F6TZ3050FB





**EXPEDITION U222 2003 - 2006**

Imagen	Clave del Producto y Descripción	Detalles	OEM
	<b>FO6134</b> Horquilla & Tijera	Peso : 3,500 kg / 7.716 lb Tipo de Material : Acero Forjado	4L1Z3084CA, 6L1Z3084BA
	<b>FO6135</b> Horquilla & Tijera	Peso : 3,500 kg / 7.716 lb Tipo de Material : Acero Forjado	4L1Z3085CA, 6L1Z3085BA

**EXPEDITION UN93 1997 - 2002**

Imagen	Clave del Producto y Descripción	Detalles	OEM
	<b>FO2085</b> Terminal Exterior	Peso : 0,730 kg / 1.609 lb Longitud : 166 mm / 6.54 inch	2L3Z3A130AA, F65Z3A130AA
	<b>FO2086</b> Terminal Exterior	Peso : 0,730 kg / 1.609 lb Longitud : 166 mm / 6.54 inch	2L3Z3A130BA, F65Z3A130BA
	<b>FO4078</b> Tornillo Estabilizador	Peso : 0,762 kg / 1.680 lb Longitud : 381 mm / 15.00 inch	YL1Z5K484AA

**EXPLORER U152 2002 - 2005**

Imagen	Clave del Producto y Descripción	Detalles	OEM
	<b>FO2092</b> Terminal Exterior	Peso : 0,578 kg / 1.274 lb Longitud : 124 mm / 4.88 inch	4L2Z3A130AA, 5L2Z3A130AA
	<b>LC2001</b> Terminal Exterior	Peso : 1,369 kg / 3.018 lb Longitud : 585 mm / 23.03 inch	1L2Z5A972AB, 2L2Z5A972AA
	<b>LC2002</b> Terminal Exterior		1L2Z5A972AB, 2L2Z5A972AA
	<b>LC20012002</b> Terminales Completas	Peso : 1,743 kg / 3.843 lb Terminal Exterior : LC2001 Terminal Interior : LC2002	1L2Z5A972AB*, 2L2Z5A972AA*

**EXPLORER U251 2006 - 2010**

Imagen	Clave del Producto y Descripción	Detalles	OEM
	<b>FO4081</b> Tornillo Estabilizador	Peso : 0,336 kg / 0.741 lb Longitud : 163 mm / 6.42 inch	6L2Z5K484BA

**EXPLORER U502 2011 - 2017**

Imagen	Clave del Producto y Descripción	Detalles	OEM
	<b>FO6107K</b> Horquilla & Tijera	Peso : 7,424 kg / 16.367 lb Tipo de Material : Döküm Çelik	BB5Z3078A, BB5Z3078B GB5Z3078A, GB5Z3078C GB5Z3078D, GB5Z3078E
	<b>FO6108K</b> Horquilla & Tijera	Peso : 7,424 kg / 16.367 lb Tipo de Material : Döküm Çelik	BB5Z3079A, BB5Z3079B GB5Z3079A, GB5Z3079F GB5Z3079G

**EXPLORER UN150 1995 - 2001**

Imagen	Clave del Producto y Descripción	Detalles	OEM
	<b>FO2093</b> Terminal Exterior	Peso : 0,556 kg / 1.226 lb Longitud : 112 mm / 4.41 inch	5L5Z3A130AA, F87Z3A130BA ZZP032365, ZZP032365A



\* Nombres de los vehículos, marcas, modelos, símbolos y logos, número OE y otros números de terceros en el sitio web y catálogo solo son con fines de referencia.



**EXPLORER UN150 1995 - 2001**

Imagen	Clave del Producto y Descripción	Detalles	OEM
	<b>FO4082</b> Tornillo Estabilizador	Peso : 0,671 kg / 1.479 lb Tipo de Material : Metal Longitud : 241 mm / 9.49 inch	F57Z5K484A, YL2Z5K484AA

**EXPLORER SPORT TRAC U152 2001 - 2005**

Imagen	Clave del Producto y Descripción	Detalles	OEM
	<b>FO2092</b> Terminal Exterior	Peso : 0,578 kg / 1.274 lb Longitud : 124 mm / 4.88 inch	4L2Z3A130AA, 5L2Z3A130AA
	<b>CV4059</b> Tornillo Estabilizador	Peso : 0,682 kg / 1.504 lb Tipo de Material : Metal	3L2Z5K484AA, 3L3Z5K484AA 4L2Z5K484AA, 5L2Z5K484AB
	<b>FO4082</b> Tornillo Estabilizador	Peso : 0,671 kg / 1.479 lb Tipo de Material : Metal Longitud : 241 mm / 9.49 inch	F57Z5K484A, YL2Z5K484AA

**EXPLORER SPORT TRAC U251 2006 - 2010**

Imagen	Clave del Producto y Descripción	Detalles	OEM
	<b>FO4081</b> Tornillo Estabilizador	Peso : 0,336 kg / 0.741 lb Longitud : 163 mm / 6.42 inch	6L2Z5K484BA

**F-150 X 1997 - 2003**

Imagen	Clave del Producto y Descripción	Detalles	OEM
	<b>FO2085</b> Terminal Exterior	Peso : 0,730 kg / 1.609 lb Longitud : 166 mm / 6.54 inch	2L3Z3A130AA, F65Z3A130AA
	<b>FO2086</b> Terminal Exterior	Peso : 0,730 kg / 1.609 lb Longitud : 166 mm / 6.54 inch	2L3Z3A130BA, F65Z3A130BA

**F-150 XI 2004 - 2008**

Imagen	Clave del Producto y Descripción	Detalles	OEM
	<b>FO2078</b> TERMINAL EXTERIOR FRONTAL EXTERIOR	Peso : 0,598 kg / 1.318 lb Longitud : 115 mm / 4.53 inch	4L3Z3A130CA

**F-250 1987 - 1991**

Imagen	Clave del Producto y Descripción	Detalles	OEM
	<b>FO1054</b> Rotula	Peso : 0,740 kg / 1.631 lb Medida de Cono : Ø22,5 Diámetro de Cuerda del Perno : 3/4-16 UNF Diámetro del Cuerpo de la Rotu : Ø50,2	5C3Z3050D, 5C3Z3050DA 8C3Z3050D, 8C3Z3050DA E7TZ3050B, F6TZ3050AB F6TZ3050FB

**F-250 1992 - 1997**

Imagen	Clave del Producto y Descripción	Detalles	OEM
	<b>FO1054</b> Rotula	Peso : 0,740 kg / 1.631 lb Medida de Cono : Ø22,5 Diámetro de Cuerda del Perno : 3/4-16 UNF Diámetro del Cuerpo de la Rotu : Ø50,2	5C3Z3050D, 5C3Z3050DA 8C3Z3050D, 8C3Z3050DA E7TZ3050B, F6TZ3050AB F6TZ3050FB



**F-250 1997 - 1999**

Imagen	Clave del Producto y Descripción	Detalles	OEM
	<b>FO2085</b> Terminal Exterior	Peso : 0,730 kg / 1.609 lb Longitud : 166 mm / 6.54 inch	2L3Z3A130AA, F65Z3A130AA
	<b>FO2086</b> Terminal Exterior	Peso : 0,730 kg / 1.609 lb Longitud : 166 mm / 6.54 inch	2L3Z3A130BA, F65Z3A130BA

**F-250 SUPER DUTY 1999 - 2007**

Imagen	Clave del Producto y Descripción	Detalles	OEM
	<b>FO1054</b> Rotula	Peso : 0,740 kg / 1.631 lb Medida de Cono : Ø22,5 Diámetro de Cuerda del Perno : 3/4-16 UNF Diámetro del Cuerpo de la Rotu : Ø50,2	5C3Z3050D, 5C3Z3050DA 8C3Z3050D, 8C3Z3050DA E7TZ3050B, F6TZ3050AB F6TZ3050FB

**F-250 SUPER DUTY**
**2008 - 2010**

Imagen	Clave del Producto y Descripción	Detalles	OEM
	<b>FO1054</b> Rotula	Peso : 0,740 kg / 1.631 lb Medida de Cono : Ø22,5 Diámetro de Cuerda del Perno : 3/4-16 UNF Diámetro del Cuerpo de la Rotu : Ø50,2	5C3Z3050D, 5C3Z3050DA 8C3Z3050D, 8C3Z3050DA E7TZ3050B, F6TZ3050AB F6TZ3050FB
	<b>FO2081</b> TERMINAL EXTERIOR FRONTAL EXTERIOR DERECHO	Peso : 1,188 kg / 2.619 lb Longitud : 97,3 mm / 3.83 inch	8C3Z3A131K, AC3Z3A131A
	<b>FO2082</b> TERMINAL EXTERIOR FRONTAL EXTERIOR IZQUIERDO	Peso : 1,188 kg / 2.619 lb Longitud : 97,3 mm / 3.83 inch	AC3Z3A131AA

**F-250 SUPER DUTY**
**2011 - 2016**

Imagen	Clave del Producto y Descripción	Detalles	OEM
	<b>FO1054</b> Rotula	Peso : 0,740 kg / 1.631 lb Medida de Cono : Ø22,5 Diámetro de Cuerda del Perno : 3/4-16 UNF Diámetro del Cuerpo de la Rotu : Ø50,2	5C3Z3050D, 5C3Z3050DA 8C3Z3050D, 8C3Z3050DA E7TZ3050B, F6TZ3050AB F6TZ3050FB

**F-250 SUPER DUTY**
**2017 - 2022**

Imagen	Clave del Producto y Descripción	Detalles	OEM
	<b>FO1054</b> Rotula	Peso : 0,740 kg / 1.631 lb Medida de Cono : Ø22,5 Diámetro de Cuerda del Perno : 3/4-16 UNF Diámetro del Cuerpo de la Rotu : Ø50,2	5C3Z3050D, 5C3Z3050DA 8C3Z3050D, 8C3Z3050DA E7TZ3050B, F6TZ3050AB F6TZ3050FB

**F-350**
**1987 - 1991**

Imagen	Clave del Producto y Descripción	Detalles	OEM
	<b>FO1054</b> Rotula	Peso : 0,740 kg / 1.631 lb Medida de Cono : Ø22,5 Diámetro de Cuerda del Perno : 3/4-16 UNF Diámetro del Cuerpo de la Rotu : Ø50,2	5C3Z3050D, 5C3Z3050DA 8C3Z3050D, 8C3Z3050DA E7TZ3050B, F6TZ3050AB F6TZ3050FB

**F-350**
**1992 - 1997**

Imagen	Clave del Producto y Descripción	Detalles	OEM
	<b>FO1054</b> Rotula	Peso : 0,740 kg / 1.631 lb Medida de Cono : Ø22,5 Diámetro de Cuerda del Perno : 3/4-16 UNF Diámetro del Cuerpo de la Rotu : Ø50,2	5C3Z3050D, 5C3Z3050DA 8C3Z3050D, 8C3Z3050DA E7TZ3050B, F6TZ3050AB F6TZ3050FB

\* Nombres de los vehículos, marcas, modelos, símbolos y logos, número OE y otros números de terceros en el sitio web y catálogo solo son con fines de referencia.

**F-350 SUPER DUTY**
**1999 - 2007**

Imagen	Clave del Producto y Descripción	Detalles	OEM
	<b>FO1054</b> Rotula	Peso : 0,740 kg / 1.631 lb Medida de Cono : Ø22,5 Diámetro de Cuerda del Perno : 3/4-16 UNF Diámetro del Cuerpo de la Rotu : Ø50,2	5C3Z3050D, 5C3Z3050DA 8C3Z3050D, 8C3Z3050DA E7TZ3050B, F6TZ3050AB F6TZ3050FB

**F-350 SUPER DUTY**
**2008 - 2010**

Imagen	Clave del Producto y Descripción	Detalles	OEM
	<b>FO1054</b> Rotula	Peso : 0,740 kg / 1.631 lb Medida de Cono : Ø22,5 Diámetro de Cuerda del Perno : 3/4-16 UNF Diámetro del Cuerpo de la Rotu : Ø50,2	5C3Z3050D, 5C3Z3050DA 8C3Z3050D, 8C3Z3050DA E7TZ3050B, F6TZ3050AB F6TZ3050FB
	<b>FO2081</b> TERMINAL EXTERIOR FRONTAL EXTERIOR DERECHO	Peso : 1,188 kg / 2.619 lb Longitud : 97,3 mm / 3.83 inch	8C3Z3A131K, AC3Z3A131A
	<b>FO2082</b> TERMINAL EXTERIOR FRONTAL EXTERIOR IZQUIERDO	Peso : 1,188 kg / 2.619 lb Longitud : 97,3 mm / 3.83 inch	AC3Z3A131AA

**F-350 SUPER DUTY**
**2011 - 2016**

Imagen	Clave del Producto y Descripción	Detalles	OEM
	<b>FO1054</b> Rotula	Peso : 0,740 kg / 1.631 lb Medida de Cono : Ø22,5 Diámetro de Cuerda del Perno : 3/4-16 UNF Diámetro del Cuerpo de la Rotu : Ø50,2	5C3Z3050D, 5C3Z3050DA 8C3Z3050D, 8C3Z3050DA E7TZ3050B, F6TZ3050AB F6TZ3050FB

**F-350 SUPER DUTY**
**2017 - 2022**

Imagen	Clave del Producto y Descripción	Detalles	OEM
	<b>FO1054</b> Rotula	Peso : 0,740 kg / 1.631 lb Medida de Cono : Ø22,5 Diámetro de Cuerda del Perno : 3/4-16 UNF Diámetro del Cuerpo de la Rotu : Ø50,2	5C3Z3050D, 5C3Z3050DA 8C3Z3050D, 8C3Z3050DA E7TZ3050B, F6TZ3050AB F6TZ3050FB

**FAIRMONT**
**1978 - 1983**

Imagen	Clave del Producto y Descripción	Detalles	OEM
	<b>FO4080</b> Tornillo Estabilizador	Peso : 0,322 kg / 0.710 lb Longitud : 233,5 mm / 9.19 inch	D8BZ5A486A, E6LY5A486A E6ZZ5A486A, F1ZZ5A486A

\* Nombres de los vehículos, marcas, modelos, símbolos y logos, número OE y otros números de terceros en el sitio web y catálogo solo son con fines de referencia.

**FALCON I 1960 - 1963**

Imagen	Clave del Producto y Descripción	Detalles	OEM
	<b>CD4005</b> Tornillo Estabilizador	Peso : 0,220 kg / 0.485 lb Longitud : 145 mm / 5.71 inch	25679063, 3879218

**FALCON II 1964 - 1965**

Imagen	Clave del Producto y Descripción	Detalles	OEM
	<b>CD4005</b> Tornillo Estabilizador	Peso : 0,220 kg / 0.485 lb Longitud : 145 mm / 5.71 inch	25679063, 3879218

**FIESTA VI 2008 - 2016**

Imagen	Clave del Producto y Descripción	Detalles	OEM
	<b>FI13016K</b> Cubre Polvo De Direccion	Peso : 0.164 kg / 0.362 lb	4066.95, 77363828 77364571

**FIESTA VII 2017 -**

Imagen	Clave del Producto y Descripción	Detalles	OEM
	<b>FO3050</b> Terminal interior	Peso : 0,511 kg / 1.127 lb Longitud : 278 mm / 10.94 inch Tamaño de la Rosca : M14X1,5 Diámetro de Cuerda del Perno : M14X1,5	2090582

**FIVE HUNDRED 2005 - 2007**

Imagen	Clave del Producto y Descripción	Detalles	OEM
	<b>FO4075</b> Tornillo Estabilizador	Peso : 0,324 kg / 0.714 lb Tipo de Material : Metal Longitud : 141 mm / 5.55 inch	5F9Z5K484AS, 7F9Z5K484S





**FO8003 / Kit De Suspension Y Direccion**
**FOCUS**
**I DAW-DBW**
**1998 - 2004**

**Piezas del Kit**

Imagen	RIW Codigo / Nombre	OEM	OEM	RIW Codigo / Nombre	Imagen
	<b>FO2012</b> Terminal Exterior Frontal Derecho	1074305, 1107013 98AG3289AA, 98AX3270AA YS4Z3A130BA, YS4Z3A130CA YS4Z3A130CB	1074306, 1107015 5015546, 98AG3290AA 98AX3270BA	<b>FO2013</b> Terminal Exterior Frontal Izquierdo	
	<b>FO3010</b> Terminal Interior Delantero	1085520, 3707333 3707533, 4083655 4363162, 98AG3L519AA XS4C3280BA	1061631, 1071336 1111769, 1209035 98AG3B438AD, YS413B438AB	<b>FO4033A</b> Tornillo Estabilizador Delantero	
	<b>FO6046</b> Horquillas Frontal Derecho Inferior	1071214, 1073214 1090730, 1138160 1344966, 2M513042BA 2M513042BE, 98AG3042AJ 98AG3042AK	1073215, 1090738 1138161, 1344968 2M513051BA, 2M513051BE 98AG3051AJ, 98AG3051AK	<b>FO6047</b> Horquillas Frontal Inferior Izquierdo	

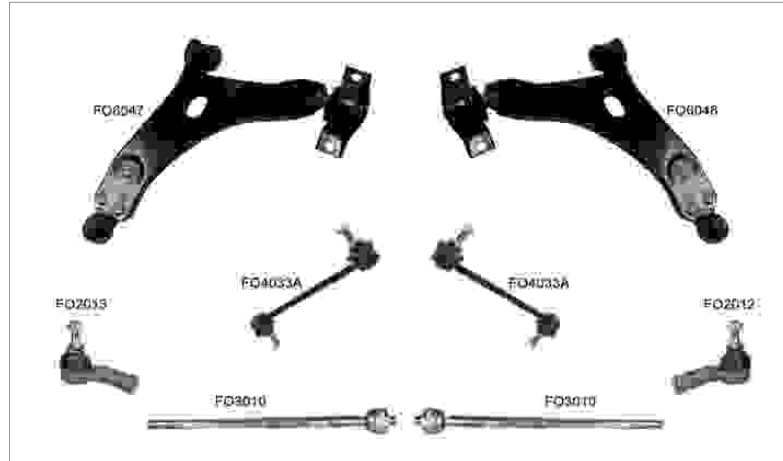
**FOCUS EU III 2011 - 2018**

Imagen	Clave del Producto y Descripción	Detalles	OEM
	<b>FO12064</b> Soporte De Motor	Peso : 2.026 kg / 4.467 lb	1872079, 2111961 F1F16F012AA, F1F16F012BB

**FOCUS US III 2011 - 2018**

Imagen	Clave del Producto y Descripción	Detalles	OEM
	<b>FO12064</b> Soporte De Motor	Peso : 2.026 kg / 4.467 lb	1872079, 2111961 F1F16F012AA, F1F16F012BB

**FREESTYLE 2005 - 2007**

Imagen	Clave del Producto y Descripción	Detalles	OEM
	<b>FO4075</b> Tornillo Estabilizador	Peso : 0,324 kg / 0.714 lb Tipo de Material : Metal Longitud : 141 mm / 5.55 inch	5F9Z5K484AS, 7F9Z5K484S

**FUSION 2006 - 2012**

Imagen	Clave del Producto y Descripción	Detalles	OEM
	<b>FO3054</b> Terminal interior	Peso : 0,407 kg / 0.897 lb Longitud : 179 mm / 7.05 inch Tamaño de la Rosca : M14X1,5 Diámetro de Cuerda del Perno : M14X1,5	AE5Z3280A

**FUSION 2013 - 2020**

Imagen	Clave del Producto y Descripción	Detalles	OEM
	<b>FO9027</b> Horquilla & Tijera	Peso : 0,756 kg / 1.667 lb Tipo de Material : Tubo De Acero	DG9Z5A972B
	<b>FO11079</b> Buje De Horquilla & Tijera	Chasis (Delantero / Trasero) : Delantero Posicion : Inferior Chico Peso : 0.558 kg / 1.230 lb	1927131*, 1927132* 5232480*, 5232481* 5303328*, 5303329* FG9C-3A052-ANA*, FG9C-3A053-ANA*
	<b>FO11080</b> Buje De Horquilla & Tijera	Chasis (Delantero / Trasero) : Delantero Posicion : Inferior Derecho Grande Otro Lado del Artículo : FO11081 Peso : 1.788 kg / 3.942 lb	1927131*, 5232480* 5303328*, FG9C-3A052-ANA*

\* Nombres de los vehículos, marcas, modelos, símbolos y logos, número OE y otros números de terceros en el sitio web y catálogo solo son con fines de referencia.

**FUSION**
**2013 - 2020**

Imagen	Clave del Producto y Descripción	Detalles	OEM
	<b>FO11081</b> Buje De Horquilla & Tijera	Chasis (Delantero / Trasero) : Delantero Posicion : Inferior Izquierda Grande Otro Lado del Artículo : FO11080 Peso : 1.788 kg / 3.942 lb	1927132*, 5232481* 5303329*, FG9C-3A053-ANA*

**GALAXIE**
**1959 - 1964**

Imagen	Clave del Producto y Descripción	Detalles	OEM
	<b>CD4005</b> Tornillo Estabilizador	Peso : 0,220 kg / 0.485 lb Longitud : 145 mm / 5.71 inch	25679063, 3879218

**GALAXIE**
**1965 - 1968**

Imagen	Clave del Producto y Descripción	Detalles	OEM
	<b>CV4056</b> Tornillo Estabilizador	Peso : 0,182 kg / 0.401 lb Longitud : 195,5 mm / 7.70 inch	25784241

**GALAXIE**
**1969 - 1970**

Imagen	Clave del Producto y Descripción	Detalles	OEM
	<b>CV4056</b> Tornillo Estabilizador	Peso : 0,182 kg / 0.401 lb Longitud : 195,5 mm / 7.70 inch	25784241

**GALAXIE**
**1971 - 1974**

Imagen	Clave del Producto y Descripción	Detalles	OEM
	<b>CV4056</b> Tornillo Estabilizador	Peso : 0,182 kg / 0.401 lb Longitud : 195,5 mm / 7.70 inch	25784241

**GALAXY**
**CK**
**2015 - 2023**

Imagen	Clave del Producto y Descripción	Detalles	OEM
	<b>FO11080</b> Buje De Horquilla & Tijera	Chasis (Delantero / Trasero) : Delantero Posicion : Inferior Derecho Grande Otro Lado del Artículo : FO11081 Peso : 1.788 kg / 3.942 lb	1927131*, 5232480* 5303328*, FG9C-3A052-ANA*

\* Nombres de los vehículos, marcas, modelos, símbolos y logos, número OE y otros números de terceros en el sitio web y catálogo solo son con fines de referencia.



**GALAXY CK 2015 - 2023**

Imagen	Clave del Producto y Descripción	Detalles	OEM
	<b>FO11081</b> Buje De Horquilla & Tijera	Chasis (Delantero / Trasero) : Delantero Posicion : Inferior Izquierda Grande Otro Lado del Artículo : FO11080 Peso : 1.788 kg / 3.942 lb	1927132*, 5232481* 5303329*, FG9C-3A053-ANA*

**GRANADA MARK I 1972 - 1977**

Imagen	Clave del Producto y Descripción	Detalles	OEM
	<b>CD4005</b> Tornillo Estabilizador	Peso : 0,220 kg / 0.485 lb Longitud : 145 mm / 5.71 inch	25679063, 3879218
	<b>FO4080</b> Tornillo Estabilizador	Peso : 0,322 kg / 0.710 lb Longitud : 233,5 mm / 9.19 inch	D8BZ5A486A, E6LY5A486A E6ZZ5A486A, F1ZZ5A486A

**KA I RB 1996 - 2008**

Imagen	Clave del Producto y Descripción	Detalles	OEM
	<b>FO1001</b> RÓTULA FRONTAL INFERIOR	Peso : 0,488 kg / 1.076 lb	1209245*, 1209246* 1448485*, 1448487*
	<b>FO6132</b> Horquilla & Tijera	Peso : 2,852 kg / 6.288 lb Tipo de Material : Chapa Metálica	1209245, 1255371 1448485
	<b>FO6133</b> Horquilla & Tijera	Peso : 2,852 kg / 6.288 lb Tipo de Material : Chapa Metálica	1209246, 1255372 1448487

**KUGA II 2013 - 2019**

Imagen	Clave del Producto y Descripción	Detalles	OEM
	<b>FO12064</b> Soporte De Motor	Peso : 2.026 kg / 4.467 lb	1872079, 2111961 F1F16F012AA, F1F16F012BB

**LTD V 1966 - 1968**

Imagen	Clave del Producto y Descripción	Detalles	OEM
	<b>CV4056</b> Tornillo Estabilizador	Peso : 0,182 kg / 0.401 lb Longitud : 195,5 mm / 7.70 inch	25784241

**LTD V 1969 - 1970**

Imagen	Clave del Producto y Descripción	Detalles	OEM
	<b>CV4056</b> Tornillo Estabilizador	Peso : 0,182 kg / 0.401 lb Longitud : 195,5 mm / 7.70 inch	25784241

**LTD V 1971 - 1978**

Imagen	Clave del Producto y Descripción	Detalles	OEM
	<b>CV4056</b> Tornillo Estabilizador	Peso : 0,182 kg / 0.401 lb Longitud : 195,5 mm / 7.70 inch	25784241

**LTD V 1979 - 1982**



Imagen	Clave del Producto y Descripción	Detalles	OEM
	<b>FO2077</b> TERMINAL EXTERIOR FRONTAL EXTERIOR	Peso : 0,450 kg / 0.992 lb Longitud : 71,1 mm / 2.80 inch	2W7Z3A130A, 2W7Z3A130AA D9AZ3A130A, F3AZ3A130A F5AZ3A130A
	<b>FO2089</b> Terminal Exterior	Peso : 0,561 kg / 1.237 lb Longitud : 165 mm / 6.50 inch	2W7Z3A131A, 2W7Z3A131AA D9AZ3A131A, F5AZ3A131A
	<b>CV4056</b> Tornillo Estabilizador	Peso : 0,182 kg / 0.401 lb Longitud : 195,5 mm / 7.70 inch	25784241

**LTD VI 1983 - 1986**

Imagen	Clave del Producto y Descripción	Detalles	OEM
	<b>FO4080</b> Tornillo Estabilizador	Peso : 0,322 kg / 0.710 lb Longitud : 233,5 mm / 9.19 inch	D8BZ5A486A, E6LY5A486A E6ZZ5A486A, F1ZZ5A486A

\* Nombres de los vehículos, marcas, modelos, símbolos y logos, número OE y otros números de terceros en el sitio web y catálogo solo son con fines de referencia.

**MONDEO V CNG 2014 - 2022**

Imagen	Clave del Producto y Descripción	Detalles	OEM
	<b>FO9026</b> Horquilla & Tijera	Peso : 1,496 kg / 3.298 lb Tipo de Material : Tubo De Acero	5197081, DG9C5K898AXE DG9C5K89AXE
	<b>FO11079</b> Buje De Horquilla & Tijera	Chasis (Delantero / Trasero) : Delantero Posicion : Inferior Chico Peso : 0.558 kg / 1.230 lb	1927131*, 1927132* 5232480*, 5232481* 5303328*, 5303329* FG9C-3A052-ANA*, FG9C-3A053-ANA*
	<b>FO11080</b> Buje De Horquilla & Tijera	Chasis (Delantero / Trasero) : Delantero Posicion : Inferior Derecho Grande Otro Lado del Artículo : FO11081 Peso : 1.788 kg / 3.942 lb	1927131*, 5232480* 5303328*, FG9C-3A052-ANA*
	<b>FO11081</b> Buje De Horquilla & Tijera	Chasis (Delantero / Trasero) : Delantero Posicion : Inferior Izquierda Grande Otro Lado del Artículo : FO11080 Peso : 1.788 kg / 3.942 lb	1927132*, 5232481* 5303329*, FG9C-3A053-ANA*

**MUSTANG I 1ST FACELIFT 1965 - 1966**

Imagen	Clave del Producto y Descripción	Detalles	OEM
	<b>CD4005</b> Tornillo Estabilizador	Peso : 0,220 kg / 0.485 lb Longitud : 145 mm / 5.71 inch	25679063, 3879218

**MUSTANG I 2ND FACELIFT 1967 - 1968**

Imagen	Clave del Producto y Descripción	Detalles	OEM
	<b>CD4005</b> Tornillo Estabilizador	Peso : 0,220 kg / 0.485 lb Longitud : 145 mm / 5.71 inch	25679063, 3879218

**MUSTANG III 1979 - 1993**

Imagen	Clave del Producto y Descripción	Detalles	OEM
	<b>FO4080</b> Tornillo Estabilizador	Peso : 0,322 kg / 0.710 lb Longitud : 233,5 mm / 9.19 inch	D8BZ5A486A, E6LY5A486A E6ZZ5A486A, F1ZZ5A486A

**MUSTANG IV 1994 - 1998**

Imagen	Clave del Producto y Descripción	Detalles	OEM
	<b>FO3052</b> Terminal interior	Peso : 0,583 kg / 1.285 lb Longitud : 338 mm / 13.31 inch	E6DZ3280A, F6SZ3280BA

**MUSTANG IV FACELIFT 1999 - 2004**

Imagen	Clave del Producto y Descripción	Detalles	OEM
	<b>FO3052</b> Terminal interior	Peso : 0,583 kg / 1.285 lb Longitud : 338 mm / 13.31 inch	E6DZ3280A, F6SZ3280BA

**MUSTANG VI 2015 -**

Imagen	Clave del Producto y Descripción	Detalles	OEM
	<b>FO2094</b> Terminal Exterior	Peso : 0,588 kg / 1.296 lb Longitud : 112 mm / 4.41 inch	FR3Z3A130B
	<b>FO5018</b> Horquilla & Tijera	Peso : 2,058 kg / 4.537 lb Tipo de Material : Acero Forjado	FR3Z3078C
	<b>FO5019</b> Horquilla & Tijera	Peso : 2,058 kg / 4.537 lb Tipo de Material : Acero Forjado	FR3Z3079C
	<b>FO9030</b> Horquilla & Tijera	Peso : 1,049 kg / 2.313 lb Tipo de Material : Chapa Metálica	E1GZ5K898A, FR3Z5K898A FR3Z5K898B, G3GZ5K898A

**POLICE INTERCEPTOR UTILITY 2013 - 2017**

Imagen	Clave del Producto y Descripción	Detalles	OEM
	<b>FO6107K</b> Horquilla & Tijera	Peso : 7,424 kg / 16.367 lb Tipo de Material : Döküm Çelik	BB5Z3078A, BB5Z3078B GB5Z3078A, GB5Z3078C GB5Z3078D, GB5Z3078E
	<b>FO6108K</b> Horquilla & Tijera	Peso : 7,424 kg / 16.367 lb Tipo de Material : Döküm Çelik	BB5Z3079A, BB5Z3079B GB5Z3079A, GB5Z3079F GB5Z3079G

\* Nombres de los vehículos, marcas, modelos, símbolos y logos, número OE y otros números de terceros en el sitio web y catálogo solo son con fines de referencia.

**RANCHERO III 1960 - 1965**

Imagen	Clave del Producto y Descripción	Detalles	OEM
	<b>CD4005</b> Tornillo Estabilizador	Peso : 0,220 kg / 0.485 lb Longitud : 145 mm / 5.71 inch	25679063, 3879218

**RANCHERO VII 1972 - 1976**

Imagen	Clave del Producto y Descripción	Detalles	OEM
	<b>CV4056</b> Tornillo Estabilizador	Peso : 0,182 kg / 0.401 lb Longitud : 195,5 mm / 7.70 inch	25784241

**RANCHERO VIII 1977 - 1979**

Imagen	Clave del Producto y Descripción	Detalles	OEM
	<b>CV4056</b> Tornillo Estabilizador	Peso : 0,182 kg / 0.401 lb Longitud : 195,5 mm / 7.70 inch	25784241

**RANGER ER, EQ 1998 - 2006**

Imagen	Clave del Producto y Descripción	Detalles	OEM
	<b>FO2091</b> Terminal Exterior	Peso : 0,433 kg / 0.955 lb Longitud : 84 mm / 3.31 inch Tamaño de la Rosca : M14X1,5 LHT Diámetro de Cuerda del Perno : M12X1,25	3669093, 8AU132280 UH7432280, XM343289BA
	<b>FO2093</b> Terminal Exterior	Peso : 0,556 kg / 1.226 lb Longitud : 112 mm / 4.41 inch	5L5Z3A130AA, F87Z3A130BA ZZP032365, ZZP032365A

**RANGER ET 2006 - 2012**

Imagen	Clave del Producto y Descripción	Detalles	OEM
	<b>FO2079</b> TERMINAL EXTERIOR FRONTAL EXTERIOR	Peso : 0,410 kg / 0.904 lb Longitud : 84 mm / 3.31 inch Tamaño de la Rosca : M14X1,5 LHT Diámetro de Cuerda del Perno : M12X1,25	1454897, 6M343289AA UR5632280
	<b>FO2093</b> Terminal Exterior	Peso : 0,556 kg / 1.226 lb Longitud : 112 mm / 4.41 inch	5L5Z3A130AA, F87Z3A130BA ZZP032365, ZZP032365A

\* Nombres de los vehículos, marcas, modelos, símbolos y logos, número OE y otros números de terceros en el sitio web y catálogo solo son con fines de referencia.



**RANGER TKE 2011 - 2019**

Imagen	Clave del Producto y Descripción	Detalles	OEM
	<b>FO2083</b> Terminal Exterior	Peso : 0,765 kg / 1.687 lb Longitud : 218 mm / 8.58 inch	1727226, 1920611 AB313289AA, UC2M32280
	<b>FO2084</b> Terminal Exterior	Peso : 0,765 kg / 1.687 lb Longitud : 218 mm / 8.58 inch	1729240, 1920612 AB313290AA, UC2M32290
	<b>FO3051</b> Terminal interior	Peso : 0,516 kg / 1.138 lb Longitud : 202 mm / 7.95 inch Tamaño de la Rosca : M14X1,5 Diámetro de Cuerda del Perno : M14X1,5	1732879, 1775547 AB313280AA, AB313280AB UC2M3224X, UC2M3224XA

**S-MAX CJ 2015 - 2023**

Imagen	Clave del Producto y Descripción	Detalles	OEM
	<b>FO11080</b> Buje De Horquilla & Tijera	Chasis (Delantero / Trasero) : Delantero Posicion : Inferior Derecho Grande Otro Lado del Artículo : FO11081 Peso : 1.788 kg / 3.942 lb	1927131*, 5232480* 5303328*, FG9C-3A052-ANA*
	<b>FO11081</b> Buje De Horquilla & Tijera	Chasis (Delantero / Trasero) : Delantero Posicion : Inferior Izquierda Grande Otro Lado del Artículo : FO11080 Peso : 1.788 kg / 3.942 lb	1927132*, 5232481* 5303329*, FG9C-3A053-ANA*

**TAURUS 1986 - 1991**

Imagen	Clave del Producto y Descripción	Detalles	OEM
	<b>FO3052</b> Terminal interior	Peso : 0,583 kg / 1.285 lb Longitud : 338 mm / 13.31 inch	E6DZ3280A, F6SZ3280BA
	<b>FO4076</b> Tornillo Estabilizador	Peso : 0,478 kg / 1.054 lb Tipo de Material : Metal Longitud : 265 mm / 10.43 inch Diámetro de Cuerda del Perno : M12X1,75	E6DZ5K484A, F4DZ5K484A F78Z5K483AA
	<b>FO4079</b> Tornillo Estabilizador	Peso : 0,276 kg / 0.608 lb Longitud : 288 mm / 11.34 inch	E6DZ5A486A, E9DZ5A486A









**TAURUS**
**1992 - 1995**

Imagen	Clave del Producto y Descripción	Detalles	OEM
	<b>FO3052</b> Terminal interior	Peso : 0,583 kg / 1.285 lb Longitud : 338 mm / 13.31 inch	E6DZ3280A, F6SZ3280BA
	<b>FO4076</b> Tornillo Estabilizador	Peso : 0,478 kg / 1.054 lb Tipo de Material : Metal Longitud : 265 mm / 10.43 inch Diámetro de Cuerda del Perno : M12X1,75	E6DZ5K484A, F4DZ5K484A F78Z5K483AA
	<b>FO4079</b> Tornillo Estabilizador	Peso : 0,276 kg / 0.608 lb Longitud : 288 mm / 11.34 inch	E6DZ5A486A, E9DZ5A486A

**TAURUS**
**1996 - 1999**

Imagen	Clave del Producto y Descripción	Detalles	OEM
	<b>FO1053</b> Rotula	Peso : 0,354 kg / 0.780 lb	5F1Z3050A, 5F1Z3V050A F5OY3K185A, F5OY3K186A F6DZ3K185A, F6DZ3K186A XF1Z3050AA
	<b>FO2080</b> TERMINAL EXTERIOR FRONTAL EXTERIOR	Peso : 0,505 kg / 1.113 lb Longitud : 102 mm / 4.02 inch	3F1Z3A130AA, F6DZ3A130A
	<b>FO3053</b> Terminal interior	Peso : 0,621 kg / 1.369 lb Longitud : 341,6 mm / 13.45 inch	1F1Z3280AA, F6DZ3280AA
	<b>FO4073</b> Tornillo Estabilizador	Peso : 0,494 kg / 1.089 lb Tipo de Material : Metal Longitud : 272 mm / 10.71 inch	1F1Z5K484AA, 1F1Z5K484BA 2F1Z5K484BA, 3F1Z5K484A 3F1Z5K484AA, F5Y05K484A F5Y05K484A
	<b>FO4074</b> Tornillo Estabilizador	Peso : 0,494 kg / 1.089 lb Tipo de Material : Metal Longitud : 272 mm / 10.71 inch	1F1Z5K483AA, 1F1Z5K483BA 3F1Z5K483A, 3F1Z5K483AA F5Y05K483A, F70Z5K483AA F70Z5K483AA
	<b>FO4079</b> Tornillo Estabilizador	Peso : 0,276 kg / 0.608 lb Longitud : 288 mm / 11.34 inch	E6DZ5A486A, E9DZ5A486A

**TAURUS**
**2000 - 2007**

Imagen	Clave del Producto y Descripción	Detalles	OEM
	<b>FO1053</b> Rotula	Peso : 0,354 kg / 0.780 lb	5F1Z3050A, 5F1Z3V050A F5OY3K185A, F5OY3K186A F6DZ3K185A, F6DZ3K186A XF1Z3050AA
	<b>FO2080</b> TERMINAL EXTERIOR FRONTAL EXTERIOR	Peso : 0,505 kg / 1.113 lb Longitud : 102 mm / 4.02 inch	3F1Z3A130AA, F6DZ3A130A
	<b>FO3053</b> Terminal interior	Peso : 0,621 kg / 1.369 lb Longitud : 341,6 mm / 13.45 inch	1F1Z3280AA, F6DZ3280AA
	<b>FO4073</b> Tornillo Estabilizador	Peso : 0,494 kg / 1.089 lb Tipo de Material : Metal Longitud : 272 mm / 10.71 inch	1F1Z5K484AA, 1F1Z5K484BA 2F1Z5K484BA, 3F1Z5K484A 3F1Z5K484AA, F5Y05K484A F5Y05K484A
	<b>FO4074</b> Tornillo Estabilizador	Peso : 0,494 kg / 1.089 lb Tipo de Material : Metal Longitud : 272 mm / 10.71 inch	1F1Z5K483AA, 1F1Z5K483BA 3F1Z5K483A, 3F1Z5K483AA F5Y05K483A, F70Z5K483AA F70Z5K483AA
	<b>FO4079</b> Tornillo Estabilizador	Peso : 0,276 kg / 0.608 lb Longitud : 288 mm / 11.34 inch	E6DZ5A486A, E9DZ5A486A
	<b>FO6136</b> Horquilla & Tijera	Peso : 3,460 kg / 7.628 lb Tipo de Material : Chapa Metálica	3F1Z3078AA, F8DZ3078AB
	<b>FO6137</b> Horquilla & Tijera	Peso : 3,460 kg / 7.628 lb Tipo de Material : Chapa Metálica	3F1Z3079AA, F8DZ3079AB

**TAURUS**
**2008 - 2009**

Imagen	Clave del Producto y Descripción	Detalles	OEM
	<b>FO4075</b> Tornillo Estabilizador	Peso : 0,324 kg / 0.714 lb Tipo de Material : Metal Longitud : 141 mm / 5.55 inch	5F9Z5K484AS, 7F9Z5K484S



**THUNDERBIRD IX 1983 - 1988**

Imagen	Clave del Producto y Descripción	Detalles	OEM
	<b>FO4080</b> Tornillo Estabilizador	Peso : 0,322 kg / 0.710 lb Longitud : 233,5 mm / 9.19 inch	D8BZ5A486A, E6LY5A486A E6ZZ5A486A, F1ZZ5A486A

**THUNDERBIRD VI 1972 - 1976**

Imagen	Clave del Producto y Descripción	Detalles	OEM
	<b>CV4056</b> Tornillo Estabilizador	Peso : 0,182 kg / 0.401 lb Longitud : 195,5 mm / 7.70 inch	25784241

**THUNDERBIRD VII 1977 - 1979**

Imagen	Clave del Producto y Descripción	Detalles	OEM
	<b>CV4056</b> Tornillo Estabilizador	Peso : 0,182 kg / 0.401 lb Longitud : 195,5 mm / 7.70 inch	25784241

**THUNDERBIRD X 1989 - 1997**

Imagen	Clave del Producto y Descripción	Detalles	OEM
	<b>FO3052</b> Terminal interior	Peso : 0,583 kg / 1.285 lb Longitud : 338 mm / 13.31 inch	E6DZ3280A, F6SZ3280BA

**TRANSIT V363 2014 -**

Imagen	Clave del Producto y Descripción	Detalles	OEM
	<b>F113016K</b> Cubre Polvo De Direccion	Peso : 0.164 kg / 0.362 lb	4066.95, 77363828 77364571

**TRANSIT CONNECT 2002 - 2013**

Imagen	Clave del Producto y Descripción	Detalles	OEM
	<b>FO13003K</b> Cubre Polvo De Direccion	Peso : 0.27 kg / 0.595 lb	2T143K661AA, 4381841

**TRANSIT CONNECT**

II

**2013 -**

Imagen	Clave del Producto y Descripción	Detalles	OEM
	<b>FO12064</b> Soporte De Motor	Peso : 2.026 kg / 4.467 lb	1872079, 2111961 F1F16F012AA, F1F16F012BB

**WINDSTAR**
**1995 - 2003**

Imagen	Clave del Producto y Descripción	Detalles	OEM
	<b>FO4076</b> Tornillo Estabilizador	Peso : 0,478 kg / 1.054 lb Tipo de Material : Metal Longitud : 265 mm / 10.43 inch Diámetro de Cuerda del Perno : M12X1,75	E6DZ5K484A, F4DZ5K484A F78Z5K483AA

**RIW<sup>®</sup>**

**GMC**

**ACADIA**
**2017 -**

Imagen	Clave del Producto y Descripción	Detalles	OEM
	<b>BU2002</b> Terminal Exterior	Peso : 0,826 kg / 1.821 lb	23214216
	<b>BU2003</b> Terminal Exterior	Peso : 0,826 kg / 1.821 lb	23214215

**C1500**
**PICKUP**
**1988 - 1999**

Imagen	Clave del Producto y Descripción	Detalles	OEM
	<b>CV1035</b> RÓTULA FRONTAL SUPERIOR	Peso : 0,668 kg / 1.473 lb	15575901, 15617715 15634385, 15634904 15659518, 15687080
	<b>CD4004</b> Tornillo Estabilizador	Peso : 0,264 kg / 0.582 lb Longitud : 184 mm / 7.24 inch	10023178, 10164176 C1VY5A484A

**C1500**
**SUBURBAN**
**1992 - 1999**

Imagen	Clave del Producto y Descripción	Detalles	OEM
	<b>CV1035</b> RÓTULA FRONTAL SUPERIOR	Peso : 0,668 kg / 1.473 lb	15575901, 15617715 15634385, 15634904 15659518, 15687080
	<b>CD4004</b> Tornillo Estabilizador	Peso : 0,264 kg / 0.582 lb Longitud : 184 mm / 7.24 inch	10023178, 10164176 C1VY5A484A

**C2500**
**PICKUP**
**1988 - 1999**

Imagen	Clave del Producto y Descripción	Detalles	OEM
	<b>CV1035</b> RÓTULA FRONTAL SUPERIOR	Peso : 0,668 kg / 1.473 lb	15575901, 15617715 15634385, 15634904 15659518, 15687080
	<b>CD4004</b> Tornillo Estabilizador	Peso : 0,264 kg / 0.582 lb Longitud : 184 mm / 7.24 inch	10023178, 10164176 C1VY5A484A

\* Nombres de los vehículos, marcas, modelos, símbolos y logos, número OE y otros números de terceros en el sitio web y catálogo solo son con fines de referencia.

**C2500 SUBURBAN 1992 - 1999**

Imagen	Clave del Producto y Descripción	Detalles	OEM
	<b>CD4004</b> Tornillo Estabilizador	Peso : 0,264 kg / 0.582 lb Longitud : 184 mm / 7.24 inch	10023178, 10164176 C1VY5A484A

**ENVOY 2002 - 2009**

Imagen	Clave del Producto y Descripción	Detalles	OEM
	<b>CV3035</b> Terminal interior	Peso : 0,534 kg / 1.177 lb Longitud : 135 mm / 5.31 inch	26100288, 8261002880
	<b>CV4056</b> Tornillo Estabilizador	Peso : 0,182 kg / 0.401 lb Longitud : 195,5 mm / 7.70 inch	25784241

**JIMMY IV 1995 - 2005**

Imagen	Clave del Producto y Descripción	Detalles	OEM
	<b>CV4055</b> Tornillo Estabilizador	Peso : 0,320 kg / 0.705 lb Longitud : 118 mm / 4.65 inch	15996064

**SAFARI 1984 - 1994**

Imagen	Clave del Producto y Descripción	Detalles	OEM
	<b>CV1034</b> RÓTULA FRONTAL INFERIOR	Peso : 0,913 kg / 2.013 lb	7808865, 7814131 88965475, 9754378 9761498, 9766421
	<b>CD4004</b> Tornillo Estabilizador	Peso : 0,264 kg / 0.582 lb Longitud : 184 mm / 7.24 inch	10023178, 10164176 C1VY5A484A

**SAFARI 1995 - 2005**

Imagen	Clave del Producto y Descripción	Detalles	OEM
	<b>CV1034</b> RÓTULA FRONTAL INFERIOR	Peso : 0,913 kg / 2.013 lb	7808865, 7814131 88965475, 9754378 9761498, 9766421

\* Nombres de los vehículos, marcas, modelos, símbolos y logos, número OE y otros números de terceros en el sitio web y catálogo solo son con fines de referencia.

**SAFARI**
**1995 - 2005**

Imagen	Clave del Producto y Descripción	Detalles	OEM
	<b>CV1035</b> RÓTULA FRONTAL SUPERIOR	Peso : 0,668 kg / 1.473 lb	15575901, 15617715 15634385, 15634904 15659518, 15687080
	<b>CD4004</b> Tornillo Estabilizador	Peso : 0,264 kg / 0.582 lb Longitud : 184 mm / 7.24 inch	10023178, 10164176 C1VY5A484A

**SAVANA 1500**
**1996 - 2002**

Imagen	Clave del Producto y Descripción	Detalles	OEM
	<b>CV1035</b> RÓTULA FRONTAL SUPERIOR	Peso : 0,668 kg / 1.473 lb	15575901, 15617715 15634385, 15634904 15659518, 15687080

**SAVANA 2500**
**1996 - 2002**

Imagen	Clave del Producto y Descripción	Detalles	OEM
	<b>CV1035</b> RÓTULA FRONTAL SUPERIOR	Peso : 0,668 kg / 1.473 lb	15575901, 15617715 15634385, 15634904 15659518, 15687080

**SAVANA 2500**
**2006 - 2017**

Imagen	Clave del Producto y Descripción	Detalles	OEM
	<b>CV3037</b> Terminal interior	Peso : 0,692 kg / 1.526 lb Longitud : 331,5 mm / 13.05 inch	12479168, 19149613 19257595

**SAVANA 3500**
**2003 - 2007**

Imagen	Clave del Producto y Descripción	Detalles	OEM
	<b>CV3037</b> Terminal interior	Peso : 0,692 kg / 1.526 lb Longitud : 331,5 mm / 13.05 inch	12479168, 19149613 19257595

**SAVANA 3500**
**2008 - 2017**

Imagen	Clave del Producto y Descripción	Detalles	OEM
	<b>CV3037</b> Terminal interior	Peso : 0,692 kg / 1.526 lb Longitud : 331,5 mm / 13.05 inch	12479168, 19149613 19257595

**SAVANA 4500**
**2009 - 2016**

Imagen	Clave del Producto y Descripción	Detalles	OEM
	<b>CV3037</b> Terminal interior	Peso : 0,692 kg / 1.526 lb Longitud : 331,5 mm / 13.05 inch	12479168, 19149613 19257595

**SIERRA 1500**
**2001 - 2006**

Imagen	Clave del Producto y Descripción	Detalles	OEM
	<b>CV1037</b> Rotula	Peso : 1,164 kg / 2.566 lb	15015515*, 15750786*

**SIERRA 2500**
**2007 - 2019**

Imagen	Clave del Producto y Descripción	Detalles	OEM
	<b>CV3036</b> Terminal interior	Peso : 0,835 kg / 1.841 lb Longitud : 324 mm / 12.76 inch	19256660, 22913605

**SIERRA 3500**
**2007 - 2014**

Imagen	Clave del Producto y Descripción	Detalles	OEM
	<b>CV3036</b> Terminal interior	Peso : 0,835 kg / 1.841 lb Longitud : 324 mm / 12.76 inch	19256660, 22913605

**SIERRA 3500**
**2015 - 2019**

Imagen	Clave del Producto y Descripción	Detalles	OEM
	<b>CV3036</b> Terminal interior	Peso : 0,835 kg / 1.841 lb Longitud : 324 mm / 12.76 inch	19256660, 22913605

\* Nombres de los vehículos, marcas, modelos, símbolos y logos, número OE y otros números de terceros en el sitio web y catálogo solo son con fines de referencia.

**SONOMA**
**1994 - 2004**

Imagen	Clave del Producto y Descripción	Detalles	OEM
	<b>CV4055</b> Tornillo Estabilizador	Peso : 0,320 kg / 0.705 lb Longitud : 118 mm / 4.65 inch	15996064

**YUKON**
**1991 - 1995**

Imagen	Clave del Producto y Descripción	Detalles	OEM
	<b>CV1035</b> RÓTULA FRONTAL SUPERIOR	Peso : 0,668 kg / 1.473 lb	15575901, 15617715 15634385, 15634904 15659518, 15687080

**YUKON**
**1995 - 1999**

Imagen	Clave del Producto y Descripción	Detalles	OEM
	<b>CV1035</b> RÓTULA FRONTAL SUPERIOR	Peso : 0,668 kg / 1.473 lb	15575901, 15617715 15634385, 15634904 15659518, 15687080
	<b>CD4004</b> Tornillo Estabilizador	Peso : 0,264 kg / 0.582 lb Longitud : 184 mm / 7.24 inch	10023178, 10164176 C1VY5A484A

**YUKON**
**2000 - 2006**

Imagen	Clave del Producto y Descripción	Detalles	OEM
	<b>CD9001</b> Horquilla & Tijera	Peso : 3,304 kg / 7.284 lb Tipo de Material : Chapa Metálica	22868629

**YUKON**
**2015 - 2020**

Imagen	Clave del Producto y Descripción	Detalles	OEM
	<b>CD9001</b> Horquilla & Tijera	Peso : 3,304 kg / 7.284 lb Tipo de Material : Chapa Metálica	22868629



**YUKON GMT900 2007 - 2014**

Imagen	Clave del Producto y Descripción	Detalles	OEM
	<b>CD9001</b> Horquilla & Tijera	Peso : 3,304 kg / 7.284 lb Tipo de Material : Chapa Metálica	22868629

**YUKON 1500 XL 1999 - 2006**

Imagen	Clave del Producto y Descripción	Detalles	OEM
	<b>CD9001</b> Horquilla & Tijera	Peso : 3,304 kg / 7.284 lb Tipo de Material : Chapa Metálica	22868629

**YUKON 1500 XL 2007 - 2013**

Imagen	Clave del Producto y Descripción	Detalles	OEM
	<b>CD9001</b> Horquilla & Tijera	Peso : 3,304 kg / 7.284 lb Tipo de Material : Chapa Metálica	22868629

**RIW<sup>®</sup>**

**HONDA**

**ACCORD VIII 2008 - 2012**

Imagen	Clave del Producto y Descripción	Detalles	OEM
	<b>AC9002</b> Horquilla & Tijera	Peso : 0,862 kg / 1.900 lb Tipo de Material : Tubo De Acero	52340TA0A00
	<b>AC9003</b> Horquilla & Tijera	Peso : 0,862 kg / 1.900 lb Tipo de Material : Tubo De Acero	52345TA0A00

**CIVIC VI EJ, EK 1996 - 2001**

Imagen	Clave del Producto y Descripción	Detalles	OEM
	<b>HN9013</b> Horquilla & Tijera	Peso : 0,336 kg / 0.741 lb Tipo de Material : Chapa Metálica	52341S04000, 52341S04A00

**HN8001 / Kit De Suspension Y Direccion**





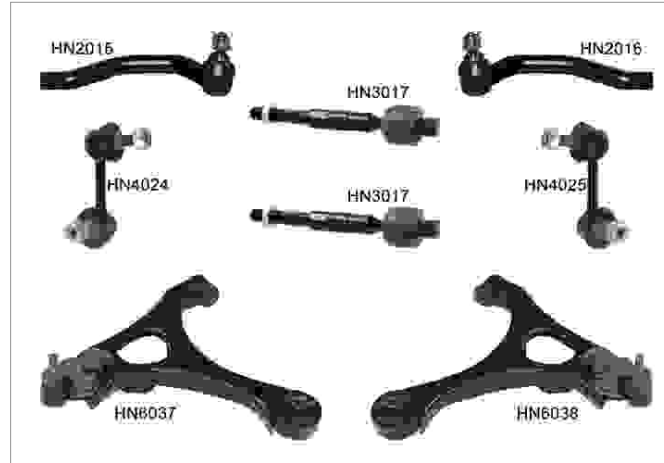

**CIVIC**

**VIII HB**

**2006 - 2012**



**Piezas del Kit**

Imagen	RIWCodigo / Nombre	OEM	OEM	RIWCodigo / Nombre	Imagen
	<b>HN2015</b> Terminal Exterior Frontal Derecho	53540SMG003, 53540-SMG003 53540SNAA01, 53540-SNAA01	53560SMG003, 53560-SMG003 53560SNAA02, 53560-SNAA02	<b>HN2016</b> Terminal Exterior Frontal Izquierdo	
	<b>HN3017</b> Terminal Interior Delantero	53560SNBJ01, 53560-SNBJ01 53610SNRA01	51320SNAA02, 51320-SNAA02	<b>HN4024</b> Tornillo Estabilizador Frontal Derecho	
	<b>HN4025</b> Tornillo Estabilizador Frontal Izquierdo	51321SNAA02, 51321-SNAA02 51321-SNA-A02	51350-S5A-A03*, 51350-SNAA03* 51350SNAA03	<b>HN6037</b> Horquillas Frontal Derecho Inferior	
	<b>HN6038</b> Horquillas Frontal Inferior Izquierdo	51360-S5A-A03*, 51360-SNAA03* 51360SNAA03			

\* Nombres de los vehiculos, marcas, modelos, simbolos y logos, numero OE y otros numeros de terceros en el sitio web y catalogo solo son con fines de referencia.

**CROSSTOUR**
**2013 - 2015**

Imagen	Clave del Producto y Descripción	Detalles	OEM
	<b>AC9002</b> Horquilla & Tijera	Peso : 0,862 kg / 1.900 lb Tipo de Material : Tubo De Acero	52340TA0A00
	<b>AC9003</b> Horquilla & Tijera	Peso : 0,862 kg / 1.900 lb Tipo de Material : Tubo De Acero	52345TA0A00

**CRV**
**1995 - 2002**

Imagen	Clave del Producto y Descripción	Detalles	OEM
	<b>HN9013</b> Horquilla & Tijera	Peso : 0,336 kg / 0.741 lb Tipo de Material : Chapa Metálica	52341S04000, 52341S04A00

**FIT**
**2013 - 2016**

Imagen	Clave del Producto y Descripción	Detalles	OEM
	<b>HN4062</b> Tornillo Estabilizador	Peso : 0,368 kg / 0.811 lb Tipo de Material : Metal Longitud : 310 mm / 12.20 inch Diámetro de Cuerda del Perno : M10X1,25	51320T5A003
	<b>HN4063</b> Tornillo Estabilizador	Peso : 0,368 kg / 0.811 lb Tipo de Material : Metal Longitud : 310 mm / 12.20 inch Diámetro de Cuerda del Perno : M10X1,25	51325T5A003

**FR-V**
**2005 - 2009**

Imagen	Clave del Producto y Descripción	Detalles	OEM
	<b>HN4058</b> Tornillo Estabilizador	Peso : 0,218 kg / 0.481 lb Tipo de Material : Metal Longitud : 72 mm / 2.83 inch	52320-SJF-003
	<b>HN4059</b> Tornillo Estabilizador	Peso : 0,218 kg / 0.481 lb Tipo de Material : Metal Longitud : 72 mm / 2.83 inch	52321-SJF-003

**HR-V RU 2015 - 2021**

Imagen	Clave del Producto y Descripción	Detalles	OEM
	<b>HN6073</b> Horquilla & Tijera	Peso : 4,802 kg / 10.587 lb Tipo de Material : Chapa Metálica	51350T8MG00
	<b>HN6073J</b> Horquilla & Tijera	Peso : 3,740 kg / 8.245 lb Tipo de Material : Chapa Metálica	51350T8MG00
	<b>HN6074</b> Horquilla & Tijera	Peso : 4,802 kg / 10.587 lb Tipo de Material : Chapa Metálica	51360T8MG00
	<b>HN6074J</b> Horquilla & Tijera	Peso : 3,740 kg / 8.245 lb Tipo de Material : Chapa Metálica	51360T8MG00

**JAZZ IV GK 2015 - 2020**



Imagen	Clave del Producto y Descripción	Detalles	OEM
	<b>HN4062</b> Tornillo Estabilizador	Peso : 0,368 kg / 0.811 lb Tipo de Material : Metal Longitud : 310 mm / 12.20 inch Diámetro de Cuerda del Perno : M10X1,25	51320T5A003
	<b>HN4063</b> Tornillo Estabilizador	Peso : 0,368 kg / 0.811 lb Tipo de Material : Metal Longitud : 310 mm / 12.20 inch Diámetro de Cuerda del Perno : M10X1,25	51325T5A003

**LEGEND KA9 1996 - 2004**

Imagen	Clave del Producto y Descripción	Detalles	OEM
	<b>AC2002</b> Terminal Exterior	Peso : 1,021 kg / 2.251 lb Longitud : 245,5 mm / 9.67 inch	53540SW5003, 53540SZ3003 53540SZ5003
	<b>AC2003</b> Terminal Exterior	Peso : 1,021 kg / 2.251 lb Longitud : 245,5 mm / 9.67 inch	53560SW5003, 53560SZ3003 53560SZ5003
	<b>AC3004</b> Terminal interior	Peso : 0,338 kg / 0.745 lb Longitud : 120,7 mm / 4.75 inch	53010S00000, 53010SS000 53010SS0000, 53010SW5003

\* Nombres de los vehículos, marcas, modelos, símbolos y logos, número OE y otros números de terceros en el sitio web y catálogo solo son con fines de referencia.

**LEGEND KB 2005 - 2012**

Imagen	Clave del Producto y Descripción	Detalles	OEM
	<b>AC2002</b> Terminal Exterior	Peso : 1,021 kg / 2.251 lb Longitud : 245,5 mm / 9.67 inch	53540SW5003, 53540SZ3003 53540SZ5003
	<b>AC2003</b> Terminal Exterior	Peso : 1,021 kg / 2.251 lb Longitud : 245,5 mm / 9.67 inch	53560SW5003, 53560SZ3003 53560SZ5003

**ODYSSEY 1999 - 2004**

Imagen	Clave del Producto y Descripción	Detalles	OEM
	<b>HN1014</b> Rotula	Peso : 0,329 kg / 0.725 lb	51350S0XA02*, 51350SOXA02* 51360S0XA02*, 51360SOXA02*
	<b>HN6071</b> Horquilla & Tijera	Peso : 6,946 kg / 15.313 lb Tipo de Material : Döküm Çelik	51350S0XA02, 51350SOXA02
	<b>HN6072</b> Horquilla & Tijera	Peso : 6,946 kg / 15.313 lb Tipo de Material : Döküm Çelik	51350S0XA02, 51350SOXA02

**ODYSSEY 2005 - 2010**

Imagen	Clave del Producto y Descripción	Detalles	OEM
	<b>HN2040</b> TERMINAL EXTERIOR FRONTAL EXTERIOR	Peso : 0,732 kg / 1.614 lb Longitud : 205 mm / 8.07 inch	53540SHJA01
	<b>HN9012</b> Horquilla & Tijera	Peso : 1,180 kg / 2.601 lb Tipo de Material : Tubo De Acero	52345-SHJ-A00, 52345-SHJ-A01

**ODYSSEY 2011 - 2017**

Imagen	Clave del Producto y Descripción	Detalles	OEM
	<b>HN9011</b> Horquilla & Tijera	Peso : 1,046 kg / 2.306 lb Tipo de Material : Tubo De Acero	52345TK8A00

\* Nombres de los vehículos, marcas, modelos, símbolos y logos, número OE y otros números de terceros en el sitio web y catálogo solo son con fines de referencia.

**PILOT II 2009 - 2015**

Imagen	Clave del Producto y Descripción	Detalles	OEM
	<b>AC9004</b> Horquilla & Tijera	Peso : 1,108 kg / 2.443 lb Tipo de Material : Tubo De Acero	04523STX000, 52345-STX-A00 52345-STX-A01, 52345-SZA-A02
	<b>HN6069</b> Horquilla & Tijera	Peso : 5,595 kg / 12.335 lb Tipo de Material : Aluminio	51350SZAA02, 51350SZAA03 51350SZAA04, 51350SZAA07
	<b>HN6070</b> Horquilla & Tijera	Peso : 5,595 kg / 12.335 lb Tipo de Material : Aluminio	51360SZAA02, 51360SZAA03 51360SZAA04, 51360SZAA07

**PRELUDE V BB 1996 - 2001**

Imagen	Clave del Producto y Descripción	Detalles	OEM
	<b>HN4061</b> Tornillo Estabilizador	Peso : 0,361 kg / 0.796 lb Longitud : 164 mm / 6.46 inch	52320S30003

**S2000 2000 - 2009**

Imagen	Clave del Producto y Descripción	Detalles	OEM
	<b>HN4060</b> Tornillo Estabilizador	Peso : 0,234 kg / 0.516 lb Tipo de Material : Metal Longitud : 92 mm / 3.62 inch	20470-AE00C, 52320-S2A-003



**RIW<sup>®</sup>**

**HUMMER**

**H2**
**2003 - 2009**

Imagen	Clave del Producto y Descripción	Detalles	OEM
	<b>CD9001</b> Horquilla & Tijera	Peso : 3,304 kg / 7.284 lb Tipo de Material : Chapa Metálica	22868629

**H3**
**2005 - 2010**

Imagen	Clave del Producto y Descripción	Detalles	OEM
	<b>HM2001</b> Terminal Exterior	Peso : 0,819 kg / 1.806 lb Longitud : 184 mm / 7.24 inch	15217992
	<b>HM2002</b> Terminal Exterior	Peso : 0,810 kg / 1.786 lb Longitud : 184 mm / 7.24 inch	15907712

**H3T**
**2009 - 2010**

Imagen	Clave del Producto y Descripción	Detalles	OEM
	<b>HM2002</b> Terminal Exterior	Peso : 0,810 kg / 1.786 lb Longitud : 184 mm / 7.24 inch	15907712

**RIW<sup>®</sup>**

**HYUNDAI**

**HY8001 / Kit De Suspension Y Direccion**

**ACCENT**

**II LC**

**2000 - 2005**

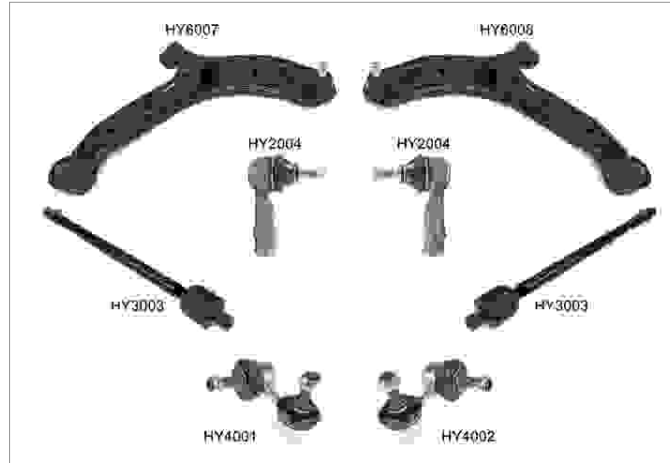

**Piezas del Kit**

Imagen	RIW Codigo / Nombre	OEM	OEM	RIW Codigo / Nombre	Imagen
	<b>HY2004</b> Terminal Exterior Delantero	5682025000, 56820-25000	56540-25000, 57755-25000 57775-25000	<b>HY3003</b> Terminal Interior Delantero	
	<b>HY4001</b> Tornillo Estabilizador Frontal Derecho	54830-17020, 5483025020 54830-25020	54830-17010, 5483025010 54830-25010	<b>HY4002</b> Tornillo Estabilizador Frontal Izquierdo	
	<b>HY6007</b> Horquillas Frontal Derecho Inferior	5450125000, 54501-25000 55202-25000	5450025000, 54500-25000 55201-25000	<b>HY6008</b> Horquillas Frontal Inferior Izquierdo	

\* Nombres de los vehiculos, marcas, modelos, simbolos y logotipos, numero OE y otros numeros de terceros en el sitio web y catalogo solo son con fines de referencia.



**AMICA**
**1998 - 2008**

Imagen	Clave del Producto y Descripción	Detalles	OEM
	<b>HY1008A</b> Rotula	Peso : 0,250 kg / 0.551 lb Medida de Cono : Ø13,4 Diámetro de Cuerda del Perno : M12X1,25 Diámetro del Cuerpo de la Rotu : Ø36	52037530, 5453002000 54530-02000, 54530-02050 5453002500

**ATOS**
**1998 - 2008**

Imagen	Clave del Producto y Descripción	Detalles	OEM
	<b>HY1008A</b> Rotula	Peso : 0,250 kg / 0.551 lb Medida de Cono : Ø13,4 Diámetro de Cuerda del Perno : M12X1,25 Diámetro del Cuerpo de la Rotu : Ø36	52037530, 5453002000 54530-02000, 54530-02050 5453002500

**AZERA**
**HG**
**2012 - 2014**

Imagen	Clave del Producto y Descripción	Detalles	OEM
	<b>HY9011</b> Horquilla & Tijera	Peso : 0,684 kg / 1.508 lb Tipo de Material : Acero Forjado	552503Z000
	<b>KI9004</b> Horquilla & Tijera	Peso : 1,242 kg / 2.738 lb Tipo de Material : Chapa Metálica	551002S050, 551003Q000 551003R000, 551003R050 551004Z100

**CADENZA**
**2014 - 2016**

Imagen	Clave del Producto y Descripción	Detalles	OEM
	<b>HY9011</b> Horquilla & Tijera	Peso : 0,684 kg / 1.508 lb Tipo de Material : Acero Forjado	552503Z000
	<b>KI9004</b> Horquilla & Tijera	Peso : 1,242 kg / 2.738 lb Tipo de Material : Chapa Metálica	551002S050, 551003Q000 551003R000, 551003R050 551004Z100

**COUPE**
**RD**
**1996 - 2002**

Imagen	Clave del Producto y Descripción	Detalles	OEM
	<b>HY6051J</b> Horquilla & Tijera	Peso : 3.715 kg / 8.190 lb Tipo de Material : Chapa Metálica	5450129000, 54501-29000

\* Nombres de los vehículos, marcas, modelos, símbolos y logos, número OE y otros números de terceros en el sitio web y catálogo solo son con fines de referencia.

**COUPE RD 1996 - 2002**

Imagen	Clave del Producto y Descripción	Detalles	OEM
	<b>HY6052J</b> Horquilla & Tijera	Peso : 3.715 kg / 8.190 lb Tipo de Material : Chapa Metálica	5450029000, 54500-29000

**CRETA 2015 -**

Imagen	Clave del Producto y Descripción	Detalles	OEM
	<b>HY2055</b> Terminal Exterior	Peso : 0,388 kg / 0.855 lb Longitud : 78 mm / 3.07 inch	56825M0000
	<b>HY2056</b> Terminal Exterior	Peso : 0,388 kg / 0.855 lb Longitud : 78 mm / 3.07 inch	56820M0000

**ELANTRA AD 2016 - 2020**

Imagen	Clave del Producto y Descripción	Detalles	OEM
	<b>HY6101</b> Horquilla & Tijera	Peso : 3,674 kg / 8.100 lb Tipo de Material : Chapa Metálica	54501F2000
	<b>HY6101J</b> Horquilla & Tijera	Peso : 2,896 kg / 6.385 lb Tipo de Material : Chapa Metálica	54501F2000
	<b>HY6102</b> Horquilla & Tijera	Peso : 3,674 kg / 8.100 lb Tipo de Material : Chapa Metálica	54500F2000
	<b>HY6102J</b> Horquilla & Tijera	Peso : 2,896 kg / 6.385 lb Tipo de Material : Chapa Metálica	54500F2000

**H350 2016 -**

Imagen	Clave del Producto y Descripción	Detalles	OEM
	<b>HY2052</b> Terminal Exterior	Peso : 0,514 kg / 1.133 lb Longitud : 90 mm / 3.54 inch	56811-59000

\* Nombres de los vehículos, marcas, modelos, símbolos y logos, número OE y otros números de terceros en el sitio web y catálogo solo son con fines de referencia.

**H350**
**2016 -**

Imagen	Clave del Producto y Descripción	Detalles	OEM
	<b>HY3044</b> Terminal interior	Peso : 0,891 kg / 1.964 lb Longitud : 399,5 mm / 15.73 inch Tamaño de la Rosca : M18X1,5 Diámetro de Cuerda del Perno : M16X1,5	5687159000

**IONIQ**
**AE ELECTRIC**
**2016 - 2022**

Imagen	Clave del Producto y Descripción	Detalles	OEM
	<b>HY6103</b> Horquilla & Tijera	Peso : 2,914 kg / 6.424 lb Tipo de Material : Aluminio	54501G2100
	<b>HY6104</b> Horquilla & Tijera	Peso : 2,914 kg / 6.424 lb Tipo de Material : Aluminio	54500G2100

**IONIQ**
**AE HYBRID**
**2016 - 2022**

Imagen	Clave del Producto y Descripción	Detalles	OEM
	<b>HY6103</b> Horquilla & Tijera	Peso : 2,914 kg / 6.424 lb Tipo de Material : Aluminio	54501G2100
	<b>HY6104</b> Horquilla & Tijera	Peso : 2,914 kg / 6.424 lb Tipo de Material : Aluminio	54500G2100

**i40**
**VF**
**2011 - 2019**

Imagen	Clave del Producto y Descripción	Detalles	OEM
	<b>HY9011</b> Horquilla & Tijera	Peso : 0,684 kg / 1.508 lb Tipo de Material : Acero Forjado	552503Z000

**iX25**
**2015 -**

Imagen	Clave del Producto y Descripción	Detalles	OEM
	<b>HY2055</b> Terminal Exterior	Peso : 0,388 kg / 0.855 lb Longitud : 78 mm / 3.07 inch	56825M0000

\* Nombres de los vehículos, marcas, modelos, símbolos y logos, número OE y otros números de terceros en el sitio web y catálogo solo son con fines de referencia.

**iX25** **2015 -**

Imagen	Clave del Producto y Descripción	Detalles	OEM
	<b>HY2056</b> Terminal Exterior	Peso : 0,388 kg / 0.855 lb Longitud : 78 mm / 3.07 inch	56820M0000

**iX35** **2010 - 2015**

Imagen	Clave del Producto y Descripción	Detalles	OEM
	<b>HY9010</b> Horquilla & Tijera	Peso : 0,650 kg / 1.433 lb Tipo de Material : Acero Forjado	55250-1D000, 55250-2S000

**KONA** **2017 - 2022**

Imagen	Clave del Producto y Descripción	Detalles	OEM
	<b>HY6101</b> Horquilla & Tijera	Peso : 3,674 kg / 8.100 lb Tipo de Material : Chapa Metálica	54501F2000
	<b>HY6101J</b> Horquilla & Tijera	Peso : 2,896 kg / 6.385 lb Tipo de Material : Chapa Metálica	54501F2000
	<b>HY6102</b> Horquilla & Tijera	Peso : 3,674 kg / 8.100 lb Tipo de Material : Chapa Metálica	54500F2000
	<b>HY6102J</b> Horquilla & Tijera	Peso : 2,896 kg / 6.385 lb Tipo de Material : Chapa Metálica	54500F2000

**PRIMA** **1998 - 2008**

Imagen	Clave del Producto y Descripción	Detalles	OEM
	<b>HY1008A</b> Rotula	Peso : 0,250 kg / 0.551 lb Medida de Cono : Ø13,4 Diámetro de Cuerda del Perno : M12X1,25 Diámetro del Cuerpo de la Rotu : Ø36	52037530, 5453002000 54530-02000, 54530-02050 5453002500



**SANTA FE**
**II CM**
**2006 - 2012**

Imagen	Clave del Producto y Descripción	Detalles	OEM
	<b>HY9008</b> Horquilla & Tijera	Peso : 1,113 kg / 2.454 lb Tipo de Material : Acero Forjado	55250-2P010
	<b>HY9009</b> Horquilla & Tijera	Peso : 1,113 kg / 2.454 lb Tipo de Material : Acero Forjado	55250-3J010



**SANTA FE**
**III DM**
**2012 - 2018**

Imagen	Clave del Producto y Descripción	Detalles	OEM
	<b>KI9004</b> Horquilla & Tijera	Peso : 1,242 kg / 2.738 lb Tipo de Material : Chapa Metálica	551002S050, 551003Q000 551003R000, 551003R050 551004Z100
	<b>HY11062</b> Buje De Horquilla & Tijera	Chasis (Delantero / Trasero) : Trasera Posicion : Peso : 0.22 kg / 0.485 lb	54551-3R000, 54551-C5000

**SANTAMO**
**1991 - 1997**

Imagen	Clave del Producto y Descripción	Detalles	OEM
	<b>MI4037</b> Tornillo Estabilizador	Peso : 0,210 kg / 0.463 lb Longitud : 140 mm / 5.51 inch Nota : FOR SPORT MODEL	4056A138, MR344624 MR555883, MR586053

**SANTAMO**
**1997 - 2003**



Imagen	Clave del Producto y Descripción	Detalles	OEM
	<b>MI4037</b> Tornillo Estabilizador	Peso : 0,210 kg / 0.463 lb Longitud : 140 mm / 5.51 inch Nota : FOR SPORT MODEL	4056A138, MR344624 MR555883, MR586053
	<b>MI4038</b> Tornillo Estabilizador	Peso : 0,398 kg / 0.877 lb Tipo de Material : Metal Longitud : 240 mm / 9.45 inch	4056A035, MR316436
	<b>MI4039</b> Tornillo Estabilizador	Peso : 0,398 kg / 0.877 lb Tipo de Material : Metal Longitud : 240 mm / 9.45 inch	4056A034, MR316435

\* Nombres de los vehículos, marcas, modelos, símbolos y logos, número OE y otros números de terceros en el sitio web y catálogo solo son con fines de referencia.





**SOLARIS**
**2017 - 2022**

Imagen	Clave del Producto y Descripción	Detalles	OEM
	<b>KI2025</b> Terminal Exterior	Peso : 0,120 kg / 0.265 lb Longitud : 454 mm / 17.87 inch	56825-H8000
	<b>KI2026</b> Terminal Exterior	Peso : 0,120 kg / 0.265 lb Longitud : 454 mm / 17.87 inch	56820-H8000

**SONATA**
**VI YF**
**2010 - 2014**

Imagen	Clave del Producto y Descripción	Detalles	OEM
	<b>HY3043</b> Terminal interior	Peso : 0,522 kg / 1.151 lb Longitud : 195 mm / 7.68 inch	577242T000
	<b>KI9003</b> Horquilla & Tijera	Peso : 0,660 kg / 1.455 lb Tipo de Material : Acero Forjado	552503Q010, 552503R000 552503S000
	<b>KI9004</b> Horquilla & Tijera	Peso : 1,242 kg / 2.738 lb Tipo de Material : Chapa Metálica	551002S050, 551003Q000 551003R000, 551003R050 551004Z100

**TERRACAN**
**HP**
**2001 - 2006**



Imagen	Clave del Producto y Descripción	Detalles	OEM
	<b>HY1033</b> Rotula	Peso : 0,536 kg / 1.182 lb	54440H1000
	<b>HY2053</b> Terminal Exterior	Peso : 0,712 kg / 1.570 lb	56850-H1001*, 56850-H1011*
	<b>HY2054</b> Terminal Exterior	Peso : 0,486 kg / 1.071 lb	56850-H1001*, 56850-H1011*
	<b>HY20532054</b> Terminales Completas	Peso : 1,502 kg / 3.311 lb Terminal Exterior : HY2053 Terminal Interior : HY2054	56850-H1001, 56850-H1011

\* Nombres de los vehículos, marcas, modelos, símbolos y logos, número OE y otros números de terceros en el sitio web y catálogo solo son con fines de referencia.

**TUCSON**
**2010 - 2015**

Imagen	Clave del Producto y Descripción	Detalles	OEM
	<b>KI9004</b> Horquilla & Tijera	Peso : 1,242 kg / 2.738 lb Tipo de Material : Chapa Metálica	551002S050, 551003Q000 551003R000, 551003R050 551004Z100

**TUCSON**
**TL**
**2015 - 2020**

Imagen	Clave del Producto y Descripción	Detalles	OEM
	<b>HY1031</b> Rotula	Peso : 0,704 kg / 1.552 lb	54530C1100, 54530D7100
	<b>HY1032</b> Rotula	Peso : 0,704 kg / 1.552 lb	54530C1000, 54530D7000
	<b>HY6089J</b> HORQUILLAS FRONTAL DERECHO INFERIOR	Peso : 0,340 kg / 0.750 lb Tipo de Material : Chapa Metálica	54501-D7000, 54501-F1000
	<b>HY6090J</b> HORQUILLAS FRONTAL INFERIOR IZQUIERDO	Peso : 0,340 kg / 0.750 lb Tipo de Material : Chapa Metálica	54500-D7000, 54500-F1000
	<b>HY11062</b> Buje De Horquilla & Tijera	Chasis (Delantero / Trasero) : Trasera Posicion : Peso : 0.22 kg / 0.485 lb	54551-3R000, 54551-C5000

**RIW<sup>®</sup>**

**INFINITI**

**FX35**
**2009 - 2012**

Imagen	Clave del Producto y Descripción	Detalles	OEM
	<b>IN3001</b> Terminal interior	Peso : 0,438 kg / 0.966 lb Longitud : 161 mm / 6.34 inch	D85211CA0A, D8E211CA0A

**FX50**
**2008 - 2013**

Imagen	Clave del Producto y Descripción	Detalles	OEM
	<b>IN3001</b> Terminal interior	Peso : 0,438 kg / 0.966 lb Longitud : 161 mm / 6.34 inch	D85211CA0A, D8E211CA0A

**G35**
**2002 - 2008**

Imagen	Clave del Producto y Descripción	Detalles	OEM
	<b>NS5001</b> Horquilla & Tijera	Peso : 1,400 kg / 3.086 lb Tipo de Material : Aluminio	54500-AM601
	<b>NS5002</b> Horquilla & Tijera	Peso : 1,400 kg / 3.086 lb Tipo de Material : Aluminio	54501-AM601

**RIW<sup>®</sup>**

**ISUZU**

**ASCENDER**
**2003 - 2008**

Imagen	Clave del Producto y Descripción	Detalles	OEM
	<b>CV3035</b> Terminal interior	Peso : 0,534 kg / 1.177 lb Longitud : 135 mm / 5.31 inch	26100288, 8261002880

**ELF N6, N7 1999 - 2003**

Imagen	Clave del Producto y Descripción	Detalles	OEM
	<b>IS2007</b> Terminal Exterior	Peso : 0,536 kg / 1.182 lb Longitud : 86 mm / 3.39 inch	8971073480, 8-97107348-0 8971073481, 8-97107348-1 8971073482, 8-97107348-2 8971421001, 8-97142100-1 8972225090, 8-97222509-0
	<b>IS2008</b> Terminal Exterior	Peso : 0,536 kg / 1.182 lb Longitud : 86 mm / 3.39 inch	8971073490, 8-97107349-0 8971073491, 8-97107349-1 8971073492, 8-97107349-2 8971421011, 8-97142101-1 8972225100, 8-97222510-0

**ELF N8 2003 -**

Imagen	Clave del Producto y Descripción	Detalles	OEM
	<b>IS2007</b> Terminal Exterior	Peso : 0,536 kg / 1.182 lb Longitud : 86 mm / 3.39 inch	8971073480, 8-97107348-0 8971073481, 8-97107348-1 8971073482, 8-97107348-2 8971421001, 8-97142100-1 8972225090, 8-97222509-0
	<b>IS2008</b> Terminal Exterior	Peso : 0,536 kg / 1.182 lb Longitud : 86 mm / 3.39 inch	8971073490, 8-97107349-0 8971073491, 8-97107349-1 8971073492, 8-97107349-2 8971421011, 8-97142101-1 8972225100, 8-97222510-0

**HOMBRE**
**1996 - 2000**

Imagen	Clave del Producto y Descripción	Detalles	OEM
	<b>CV4055</b> Tornillo Estabilizador	Peso : 0,320 kg / 0.705 lb Longitud : 118 mm / 4.65 inch	15996064

**RIW<sup>®</sup>**

**IVECO**



**DAILY III 1999 - 2006**

Imagen	Clave del Producto y Descripción	Detalles	OEM
	<b>IV3002</b> Terminal interior	Peso : 0,733 kg / 1.616 lb Longitud : 331,2 mm / 13.04 inch	42532977

**DAILY IV 2006 - 2011**

Imagen	Clave del Producto y Descripción	Detalles	OEM
	<b>IV3002</b> Terminal interior	Peso : 0,733 kg / 1.616 lb Longitud : 331,2 mm / 13.04 inch	42532977

\* Nombres de los vehículos, marcas, modelos, símbolos y logos, número OE y otros números de terceros en el sitio web y catálogo solo son con fines de referencia.

**RIW<sup>®</sup>**

**JAGUAR**

**F-PACE X761 2015 -**

Imagen	Clave del Producto y Descripción	Detalles	OEM
	<b>JG3006</b> Terminal interior	Peso : 0,553 kg / 1.219 lb Longitud : 208 mm / 8.19 inch	T4A12526, T4A12527
	<b>JG6006</b> Horquilla & Tijera	Peso : 1,160 kg / 2.557 lb Tipo de Material : Aluminio	HK833084AB, HK833084BB T4A1010, T4A1067
	<b>JG6007</b> Horquilla & Tijera	Peso : 1,160 kg / 2.557 lb Tipo de Material : Aluminio	HK833091AB, HK833091BB T4A1068, T4A1069

**F-TYPE X152 2013 -**

Imagen	Clave del Producto y Descripción	Detalles	OEM
	<b>JG3005</b> Terminal interior	Peso : 0,471 kg / 1.038 lb Longitud : 206,5 mm / 8.13 inch	8X233200AC, 8X233200BC C2D21139, C2D47149 C2Z2214, C2Z2215 DW933200AC, DW933K651AA

**I-PACE X590 2018 -**

Imagen	Clave del Producto y Descripción	Detalles	OEM
	<b>JG3006</b> Terminal interior	Peso : 0,553 kg / 1.219 lb Longitud : 208 mm / 8.19 inch	T4A12526, T4A12527

**S-TYPE X200 1999 - 2008**

Imagen	Clave del Producto y Descripción	Detalles	OEM
	<b>JG1007</b> Rotula	Peso : 0,488 kg / 1.076 lb	C2C25788, C2C25789
	<b>JG12002</b> Goma De Barra Estabilizadora	Chasis (Delantero / Trasero) : Delantero Posicion : Izquierda Y Derecha Peso : 0.09 kg / 0.198 lb	XR814128, XR81833 XR819697
	<b>JG12002K</b> Goma De Barra Estabilizadora	Chasis (Delantero / Trasero) : Delantero Posicion : Izquierda Y Derecha Peso : 0.18 kg / 0.397 lb	XR814128, XR81833 XR819697

\* Nombres de los vehículos, marcas, modelos, símbolos y logos, número OE y otros números de terceros en el sitio web y catálogo solo son con fines de referencia.

**XE X760 2015 -**

Imagen	Clave del Producto y Descripción	Detalles	OEM
	<b>JG2013</b> Terminal Exterior	Peso : 1,158 kg / 2.553 lb Longitud : 201 mm / 7.91 inch	T2H21416, T2H6305
	<b>JG2014</b> Terminal Exterior	Peso : 1,158 kg / 2.553 lb Longitud : 201 mm / 7.91 inch	T2H21417, T2H6306
	<b>JG6004</b> Horquilla & Tijera	Peso : 1,149 kg / 2.533 lb Tipo de Material : Aluminio	T2H3192
	<b>JG6005</b> Horquilla & Tijera	Peso : 1,149 kg / 2.533 lb Tipo de Material : Aluminio	T2H3193
	<b>JG11003</b> Buje De Horquilla & Tijera	Chasis (Delantero / Trasero) : Delantero Posicion : Superior Peso : 0,217 kg / 0.478 lb Nota : L=53mm	GX733084BA*, GX733091BA* HK833084AB*, HK833084BB* HK833091AB*, HK833091BB* T2H3192*, T2H3193* T4A1010*, T4A1067*

**XF X250 2008 - 2015**

Imagen	Clave del Producto y Descripción	Detalles	OEM
	<b>JG1007</b> Rotula	Peso : 0,488 kg / 1.076 lb	C2C25788, C2C25789
	<b>JG3005</b> Terminal interior	Peso : 0,471 kg / 1.038 lb Longitud : 206,5 mm / 8.13 inch	8X233200AC, 8X233200BC C2D21139, C2D47149 C2Z2214, C2Z2215 DW933200AC, DW933K651AA

**XF X260 2016 -**

Imagen	Clave del Producto y Descripción	Detalles	OEM
	<b>JG2013</b> Terminal Exterior	Peso : 1,158 kg / 2.553 lb Longitud : 201 mm / 7.91 inch	T2H21416, T2H6305
	<b>JG2014</b> Terminal Exterior	Peso : 1,158 kg / 2.553 lb Longitud : 201 mm / 7.91 inch	T2H21417, T2H6306

\* Nombres de los vehículos, marcas, modelos, símbolos y logos, número OE y otros números de terceros en el sitio web y catálogo solo son con fines de referencia.

**XF X260 2016 -**

Imagen	Clave del Producto y Descripción	Detalles	OEM
	<b>JG6004</b> Horquilla & Tijera	Peso : 1,149 kg / 2.533 lb Tipo de Material : Aluminio	T2H3192
	<b>JG6005</b> Horquilla & Tijera	Peso : 1,149 kg / 2.533 lb Tipo de Material : Aluminio	T2H3193
	<b>JG11003</b> Buje De Horquilla & Tijera	Chasis (Delantero / Trasero) : Delantero Posicion : Superior Peso : 0,217 kg / 0.478 lb Nota : L=53mm	GX733084BA*, GX733091BA* HK833084AB*, HK833084BB* HK833091AB*, HK833091BB* T2H3192*, T2H3193* T4A1010*, T4A1067*

**XJ X350 2003 - 2009**

Imagen	Clave del Producto y Descripción	Detalles	OEM
	<b>JG1007</b> Rotula	Peso : 0,488 kg / 1.076 lb	C2C25788, C2C25789
	<b>JG12002</b> Goma De Barra Estabilizadora	Chasis (Delantero / Trasero) : Delantero Posicion : Izquierda Y Derecha Peso : 0.09 kg / 0.198 lb	XR814128, XR81833 XR819697
	<b>JG12002K</b> Goma De Barra Estabilizadora	Chasis (Delantero / Trasero) : Delantero Posicion : Izquierda Y Derecha Peso : 0.18 kg / 0.397 lb	XR814128, XR81833 XR819697

**XJ X351 2010 - 2019**

Imagen	Clave del Producto y Descripción	Detalles	OEM
	<b>JG2007</b> Terminal Exterior	Peso : 1,102 kg / 2.429 lb Longitud : 215,5 mm / 8.48 inch	AW933289AA, C2D28553 C2D47156, C2D7778
	<b>JG2008</b> Terminal Exterior	Peso : 1,102 kg / 2.429 lb Longitud : 215,5 mm / 8.48 inch	AW933290AA, C2D28457 C2D47157, C2D7779

**XK X150 2007 - 2014**

Imagen	Clave del Producto y Descripción	Detalles	OEM
	<b>JG1007</b> Rotula	Peso : 0,488 kg / 1.076 lb	C2C25788, C2C25789
	<b>JG3005</b> Terminal interior	Peso : 0,471 kg / 1.038 lb Longitud : 206,5 mm / 8.13 inch	8X233200AC, 8X233200BC C2D21139, C2D47149 C2Z2214, C2Z2215 DW933200AC, DW933K651AA
	<b>JG12002</b> Goma De Barra Estabilizadora	Chasis (Delantero / Trasero) : Delantero Posicion : Izquierda Y Derecha Peso : 0.09 kg / 0.198 lb	XR814128, XR81833 XR819697
	<b>JG12002K</b> Goma De Barra Estabilizadora	Chasis (Delantero / Trasero) : Delantero Posicion : Izquierda Y Derecha Peso : 0.18 kg / 0.397 lb	XR814128, XR81833 XR819697

**XK8 COUPE X100 1996 - 2005**

Imagen	Clave del Producto y Descripción	Detalles	OEM
	<b>JG12002</b> Goma De Barra Estabilizadora	Chasis (Delantero / Trasero) : Delantero Posicion : Izquierda Y Derecha Peso : 0.09 kg / 0.198 lb	XR814128, XR81833 XR819697
	<b>JG12002K</b> Goma De Barra Estabilizadora	Chasis (Delantero / Trasero) : Delantero Posicion : Izquierda Y Derecha Peso : 0.18 kg / 0.397 lb	XR814128, XR81833 XR819697

**X-TYPE X400 2001 - 2009**

Imagen	Clave del Producto y Descripción	Detalles	OEM
	<b>JG12001</b> Goma De Barra Estabilizadora	Chasis (Delantero / Trasero) : Delantero Posicion : Izquierda Y Derecha Peso : 0.062 kg / 0.137 lb	C2S10234, C2S10879 C2S2434, C2S51258 C2S51264
	<b>JG12001K</b> Goma De Barra Estabilizadora	Chasis (Delantero / Trasero) : Delantero Posicion : Izquierda Y Derecha Peso : 0.124 kg / 0.273 lb	C2S10234, C2S10879 C2S2434, C2S51258 C2S51264

**RIW<sup>®</sup>**

**JEEP**





**CHEROKEE KJ 2001 - 2008**

Imagen	Clave del Producto y Descripción	Detalles	OEM
	<b>JP6012</b> Horquilla & Tijera	Peso : 3,336 kg / 7.355 lb Tipo de Material : Döküm Çelik	52088632AA, 52088632AB 52088632AC, 52088632AD 68068615AB
	<b>JP11005</b> Buje De Horquilla & Tijera	Chasis (Delantero / Trasero) : Delantero Posicion : Superior Peso : 0.147 kg / 0.324 lb	52088634AB, 52125369AA
	<b>JP11005K</b> Buje De Horquilla & Tijera	Chasis (Delantero / Trasero) : Delantero Posicion : Superior Peso : 0.294 kg / 0.648 lb Nota : JP11005 (X2)	52088634AB, 52125369AA

**CHEROKEE KK 2008 - 2013**



Imagen	Clave del Producto y Descripción	Detalles	OEM
	<b>JP1013</b> Rotula	Peso : 0,654 kg / 1.442 lb	52109986AH*, 52109987AH*

**CHEROKEE KL 2013 -**

Imagen	Clave del Producto y Descripción	Detalles	OEM
	<b>JP1014</b> Rotula	Peso : 0,451 kg / 0.994 lb Medida de Cono : Ø15 Diámetro de Cuerda del Perno : M12X1,5 Diámetro del Cuerpo de la Rotu : Ø44,6	4877826AF*, 4877827AF*
	<b>JP2014</b> Terminal Exterior	Peso : 0,536 kg / 1.182 lb Longitud : 94 mm / 3.70 inch	68224936AA, K68224936AA
	<b>JP2015</b> Terminal Exterior	Peso : 0,536 kg / 1.182 lb Longitud : 94 mm / 3.70 inch	68224937AA, K68224937AA
	<b>JP3007</b> Terminal interior	Peso : 0,799 kg / 1.761 lb Longitud : 336,5 mm / 13.25 inch	68224935AA, 68224935AB K68224935AA, K68224935AB



**CHEROKEE XJ 1984 - 2001**

Imagen	Clave del Producto y Descripción	Detalles	OEM
	<b>JP4020</b> Tornillo Estabilizador	Peso : 0,324 kg / 0.714 lb Tipo de Material : Metal Longitud : 194,5 mm / 7.66 inch	52001132, 52037849
	<b>DO11011</b> Buje De Horquilla & Tijera	Chasis (Delantero / Trasero) : Delantero Peso : 0.455 kg / 1.003 lb	52001161, 52002539 52037882, 52037883 52112539, 8952001161 8952001736, 8952002539
	<b>DO11011K</b> Buje De Horquilla & Tijera	Chasis (Delantero / Trasero) : Delantero Peso : 0.91 kg / 2.006 lb Nota : 2 PIECES IN 1 BOX	52001161, 52002539 52037882, 52037883 52112539, 8952001161 8952001736, 8952002539

**COMANCHE 1986 - 1992**

Imagen	Clave del Producto y Descripción	Detalles	OEM
	<b>JP4020</b> Tornillo Estabilizador	Peso : 0,324 kg / 0.714 lb Tipo de Material : Metal Longitud : 194,5 mm / 7.66 inch	52001132, 52037849
	<b>DO11011</b> Buje De Horquilla & Tijera	Chasis (Delantero / Trasero) : Delantero Peso : 0.455 kg / 1.003 lb	52001161, 52002539 52037882, 52037883 52112539, 8952001161 8952001736, 8952002539
	<b>DO11011K</b> Buje De Horquilla & Tijera	Chasis (Delantero / Trasero) : Delantero Peso : 0.91 kg / 2.006 lb Nota : 2 PIECES IN 1 BOX	52001161, 52002539 52037882, 52037883 52112539, 8952001161 8952001736, 8952002539

**JP8001 / Kit De Suspension Y Direccion**
**COMPASS**
**MK49**
**2006 - 2016**

**Piezas del Kit**

Imagen	RIW Codigo / Nombre	OEM	OEM	RIW Codigo / Nombre	Imagen
	<b>CY2002</b> Terminal Exterior Delantero	05066373AB, 05183761AD 5066373AA, K05183761AA K05183761AB, K05183761AC K68014944AA, K68141058AA	68040224AA, K68040224AA	<b>JP3004</b> Terminal Interior Delantero	
	<b>JP4010</b> Tornillo Estabilizador Delantero	05174185AC, 5174185AC	05105040AE, 05105040AG 5105040AB, 5105040AD 5105040AE, 5105040AG 5105040AH	<b>JP6005</b> Horquillas Frontal Derecho Inferior	
	<b>JP6006</b> Horquillas Frontal Inferior Izquierdo	05105041AE, 05105041AH 5105041AB, 5105041AC 5105041AE, 5105041AH			

**COMPASS MP552 2017 -**

Imagen	Clave del Producto y Descripción	Detalles	OEM
	<b>FI4025A</b> Tornillo Estabilizador	Peso : 0,450 kg / 0.992 lb Tipo de Material : Metal Longitud : 280 mm / 11.02 inch Diámetro de Cuerda del Perno : M12X1,25 Nota : M12x1,25	51939949, 51939949001 52182011, 53403318 53477126, 68246496AA001

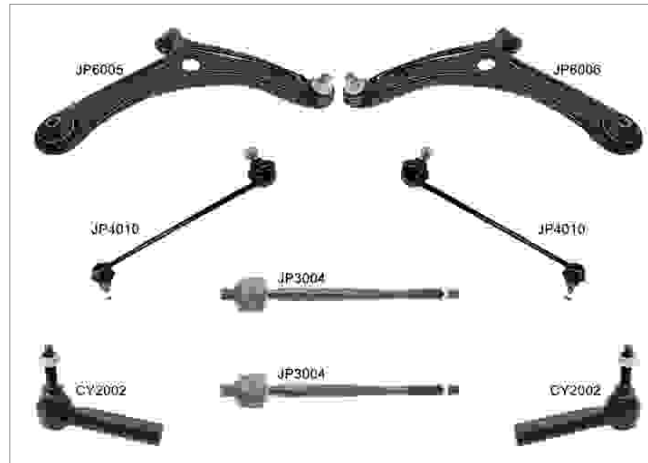
**GRAND CHEROKEE I ZJ 1991 - 1999**

Imagen	Clave del Producto y Descripción	Detalles	OEM
	<b>CD4005</b> Tornillo Estabilizador	Peso : 0,220 kg / 0.485 lb Longitud : 145 mm / 5.71 inch	25679063, 3879218
	<b>JP4020</b> Tornillo Estabilizador	Peso : 0,324 kg / 0.714 lb Tipo de Material : Metal Longitud : 194,5 mm / 7.66 inch	52001132, 52037849

**GRAND CHEROKEE II WJ, WG 1998 - 2005**

Imagen	Clave del Producto y Descripción	Detalles	OEM
	<b>JP1012</b> Rotula	Peso : 0,968 kg / 2.134 lb	52088808AB
	<b>JP2016</b> Terminal Exterior	Peso : 1,076 kg / 2.372 lb Longitud : 242 mm / 9.53 inch	52088461
	<b>JP2017</b> Terminal Exterior	Peso : 1,076 kg / 2.372 lb Longitud : 242 mm / 9.53 inch	52088511

**GRAND CHEROKEE IV WK, WK2 2011 - 2013**

Imagen	Clave del Producto y Descripción	Detalles	OEM
	<b>JP9005</b> Horquilla & Tijera	Peso : 0,968 kg / 2.134 lb Tipo de Material : Tubo De Acero	52124830AC, 52124830AD

**GRAND CHEROKEE IV WK, WK2 1ST FACELIFT 2014 - 2017**

Imagen	Clave del Producto y Descripción	Detalles	OEM
	<b>JP9005</b> Horquilla & Tijera	Peso : 0,968 kg / 2.134 lb Tipo de Material : Tubo De Acero	52124830AC, 52124830AD

**GRAND WAGONEER 1984 - 1990**

Imagen	Clave del Producto y Descripción	Detalles	OEM
	<b>DO11011</b> Buje De Horquilla & Tijera	Chasis (Delantero / Trasero) : Delantero Peso : 0.455 kg / 1.003 lb	52001161, 52002539 52037882, 52037883 52112539, 8952001161 8952001736, 8952002539
	<b>DO11011K</b> Buje De Horquilla & Tijera	Chasis (Delantero / Trasero) : Delantero Peso : 0.91 kg / 2.006 lb Nota : 2 PIECES IN 1 BOX	52001161, 52002539 52037882, 52037883 52112539, 8952001161 8952001736, 8952002539

**LIBERTY KJ 2001 - 2008**

Imagen	Clave del Producto y Descripción	Detalles	OEM
	<b>JP6012</b> Horquilla & Tijera	Peso : 3,336 kg / 7.355 lb Tipo de Material : Döküm Çelik	52088632AA, 52088632AB 52088632AC, 52088632AD 68068615AB
	<b>JP11005</b> Buje De Horquilla & Tijera	Chasis (Delantero / Trasero) : Delantero Posicion : Superior Peso : 0.147 kg / 0.324 lb	52088634AB, 52125369AA
	<b>JP11005K</b> Buje De Horquilla & Tijera	Chasis (Delantero / Trasero) : Delantero Posicion : Superior Peso : 0.294 kg / 0.648 lb Nota : JP11005 (X2)	52088634AB, 52125369AA

**LIBERTY KK 2008 - 2012**

Imagen	Clave del Producto y Descripción	Detalles	OEM
	<b>JP1013</b> Rotula	Peso : 0,654 kg / 1.442 lb	52109986AH*, 52109987AH*

**JP8001 / Kit De Suspension Y Direccion**



**PATRIOT**

**MK74**

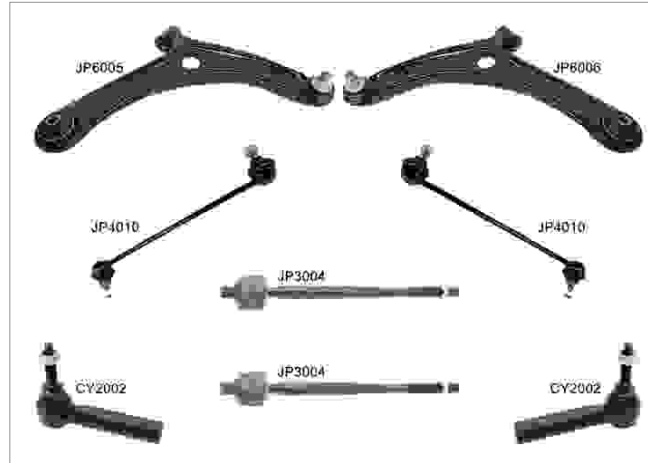
**2008 - 2015**



**Piezas del Kit**

Imagen	RIW Codigo / Nombre	OEM	OEM	RIW Codigo / Nombre	Imagen
	<b>CY2002</b> Terminal Exterior Delantero	05066373AB, 05183761AD 5066373AA, K05183761AA K05183761AB, K05183761AC K68014944AA, K68141058AA	68040224AA, K68040224AA	<b>JP3004</b> Terminal Interior Delantero	
	<b>JP4010</b> Tornillo Estabilizador Delantero	05174185AC, 5174185AC	05105040AE, 05105040AG 5105040AB, 5105040AD 5105040AE, 5105040AG 5105040AH	<b>JP6005</b> Horquillas Frontal Derecho Inferior	
	<b>JP6006</b> Horquillas Frontal Inferior Izquierdo	05105041AE, 05105041AH 5105041AB, 5105041AC 5105041AE, 5105041AH			

\* Nombres de los vehiculos, marcas, modelos, simbolos y logos, numero OE y otros numeros de terceros en el sitio web y catalogo solo son con fines de referencia.

**RENEGADE BU 2014 -**

Imagen	Clave del Producto y Descripción	Detalles	OEM
	<b>FI4025A</b> Tornillo Estabilizador	Peso : 0,450 kg / 0.992 lb Tipo de Material : Metal Longitud : 280 mm / 11.02 inch Diámetro de Cuerda del Perno : M12X1,25 Nota : M12x1,25	51939949, 51939949001 52182011, 53403318 53477126, 68246496AA001

**RENEGADE BU FACELIFT 2019 -**

Imagen	Clave del Producto y Descripción	Detalles	OEM
	<b>FI4029</b> Tornillo Estabilizador	Peso : 0,260 kg / 0.573 lb Tipo de Material : Plastico Longitud : 280 mm / 11.02 inch Diámetro de Cuerda del Perno : M12x1,25 Nota : YEARS: FROM 2018 -	68250805AA, 68348850AA

**WRANGLER II TJ 1997 - 2006**

Imagen	Clave del Producto y Descripción	Detalles	OEM
	<b>JP4001</b> Tornillo Estabilizador	Peso : 0,403 kg / 0.888 lb Tipo de Material : Metal Longitud : 177 mm / 6.97 inch	52087863, 52088896AA 52106303A, 52106303AA 52106306AA

**RIW<sup>®</sup>**

**KIA**

**CARNIVAL I UP 1999 - 2001**

Imagen	Clave del Producto y Descripción	Detalles	OEM
	<b>KI3027</b> Terminal interior	Peso : 0,563 kg / 1.241 lb Longitud : 245 mm / 9.65 inch	K55232250B

**CERATO YD 2014 - 2018**

Imagen	Clave del Producto y Descripción	Detalles	OEM
	<b>KI2029</b> Terminal Exterior	Peso : 0,726 kg / 1.601 lb Longitud : 70,3 mm / 2.77 inch	56820-A7090, 56825-A7500
	<b>KI2030</b> Terminal Exterior	Peso : 0,726 kg / 1.601 lb Longitud : 70,3 mm / 2.77 inch	56820-A7000, 56820-A7500

**FORTE 2014 - 2018**

Imagen	Clave del Producto y Descripción	Detalles	OEM
	<b>KI2029</b> Terminal Exterior	Peso : 0,726 kg / 1.601 lb Longitud : 70,3 mm / 2.77 inch	56820-A7090, 56825-A7500
	<b>KI2030</b> Terminal Exterior	Peso : 0,726 kg / 1.601 lb Longitud : 70,3 mm / 2.77 inch	56820-A7000, 56820-A7500

**FORTE5 2014 - 2018**

Imagen	Clave del Producto y Descripción	Detalles	OEM
	<b>KI2029</b> Terminal Exterior	Peso : 0,726 kg / 1.601 lb Longitud : 70,3 mm / 2.77 inch	56820-A7090, 56825-A7500
	<b>KI2030</b> Terminal Exterior	Peso : 0,726 kg / 1.601 lb Longitud : 70,3 mm / 2.77 inch	56820-A7000, 56820-A7500



**NIRO DE 2017 -**

Imagen	Clave del Producto y Descripción	Detalles	OEM
	<b>HY6103</b> Horquilla & Tijera	Peso : 2,914 kg / 6.424 lb Tipo de Material : Aluminio	54501G2100
	<b>HY6104</b> Horquilla & Tijera	Peso : 2,914 kg / 6.424 lb Tipo de Material : Aluminio	54500G2100

**OPTIMA TF 2010 - 2015**

Imagen	Clave del Producto y Descripción	Detalles	OEM
	<b>KI9003</b> Horquilla & Tijera	Peso : 0,660 kg / 1.455 lb Tipo de Material : Acero Forjado	552503Q010, 552503R000 552503S000
	<b>KI9004</b> Horquilla & Tijera	Peso : 1,242 kg / 2.738 lb Tipo de Material : Chapa Metálica	551002S050, 551003Q000 551003R000, 551003R050 551004Z100

**PICANTO JA 2017 -**

Imagen	Clave del Producto y Descripción	Detalles	OEM
	<b>KI2027</b> Terminal Exterior	Peso : 0,520 kg / 1.146 lb Longitud : 170 mm / 6.69 inch	56825-G6900
	<b>KI2028</b> Terminal Exterior	Peso : 0,520 kg / 1.146 lb Longitud : 170 mm / 6.69 inch	56820-G6000

**PICANTO TA 2011 - 2017**

Imagen	Clave del Producto y Descripción	Detalles	OEM
	<b>KI3026</b> Terminal interior	Peso : 0,476 kg / 1.049 lb Longitud : 195,5 mm / 7.70 inch Tamaño de la Rosca : M16X1,5 Diámetro de Cuerda del Perno : M14X1,5	577241Y600

**RIO IV YB 2017 -**

Imagen	Clave del Producto y Descripción	Detalles	OEM
	<b>KI2025</b> Terminal Exterior	Peso : 0,120 kg / 0.265 lb Longitud : 454 mm / 17.87 inch	56825-H8000
	<b>KI2026</b> Terminal Exterior	Peso : 0,120 kg / 0.265 lb Longitud : 454 mm / 17.87 inch	56820-H8000
	<b>KI6048</b> Horquilla & Tijera	Peso : 3,114 kg / 6.865 lb Tipo de Material : Chapa Metálica	54501H8000
	<b>KI6049</b> Horquilla & Tijera	Peso : 3,114 kg / 6.865 lb Tipo de Material : Chapa Metálica	54500H8000

**SEDONA II 2000 - 2005**

Imagen	Clave del Producto y Descripción	Detalles	OEM
	<b>KI3027</b> Terminal interior	Peso : 0,563 kg / 1.241 lb Longitud : 245 mm / 9.65 inch	K55232250B

**SORENTO I JC, BL 2002 - 2009**

Imagen	Clave del Producto y Descripción	Detalles	OEM
	<b>KI6044</b> Horquilla & Tijera	Peso : 2,567 kg / 5.659 lb Tipo de Material : Acero Forjado	54420-3E002
	<b>KI6045</b> Horquilla & Tijera	Peso : 2,567 kg / 5.659 lb Tipo de Material : Acero Forjado	54410-3E001, 54410-3E002
	<b>KI6046</b> Horquilla & Tijera	Peso : 2,604 kg / 5.741 lb Tipo de Material : Acero Forjado	54420-3E100
	<b>KI6047</b> Horquilla & Tijera	Peso : 2,604 kg / 5.741 lb Tipo de Material : Acero Forjado	54410-3E100

\* Nombres de los vehículos, marcas, modelos, símbolos y logos, número OE y otros números de terceros en el sitio web y catálogo solo son con fines de referencia.

**SORENTO II XM 2009 - 2014**

Imagen	Clave del Producto y Descripción	Detalles	OEM
	<b>HY9008</b> Horquilla & Tijera	Peso : 1,113 kg / 2.454 lb Tipo de Material : Acero Forjado	55250-2P010
	<b>HY9009</b> Horquilla & Tijera	Peso : 1,113 kg / 2.454 lb Tipo de Material : Acero Forjado	55250-3J010

**SOUL PS 2014 - 2019**

Imagen	Clave del Producto y Descripción	Detalles	OEM
	<b>KI1015</b> Rotula	Peso : 0,740 kg / 1.631 lb	54500B2000*, 54501B2000*
	<b>KI6050</b> Horquilla & Tijera	Peso : 4,188 kg / 9.233 lb Tipo de Material : Chapa Metálica	54501B2000
	<b>KI6051</b> Horquilla & Tijera	Peso : 4,188 kg / 9.233 lb Tipo de Material : Chapa Metálica	54500B2000

**SPORTAGE NB7 1993 - 2004**

Imagen	Clave del Producto y Descripción	Detalles	OEM
	<b>KI7001</b> Varilla Central	Chasis (Delantero / Trasero) : Delantero Posicion : Izquierda Y Derecha Peso : 2,424 kg / 5.344 lb Longitud : 765,5 mm / 30.14 inch	0K01132260A, K01132260A

**SPORTAGE QL 2015 - 2020**

Imagen	Clave del Producto y Descripción	Detalles	OEM
	<b>HY1031</b> Rotula	Peso : 0,704 kg / 1.552 lb	54530C1100, 54530D7100
	<b>HY1032</b> Rotula	Peso : 0,704 kg / 1.552 lb	54530C1000, 54530D7000

\* Nombres de los vehículos, marcas, modelos, símbolos y logos, número OE y otros números de terceros en el sitio web y catálogo solo son con fines de referencia.

**SPORTAGE** **QL** **2015 - 2020**

Imagen	Clave del Producto y Descripción	Detalles	OEM
	<b>HY6089J</b> HORQUILLAS FRONTAL DERECHO INFERIOR	Peso : 0,340 kg / 0.750 lb Tipo de Material : Chapa Metálica	54501-D7000, 54501-F1000
	<b>HY6090J</b> HORQUILLAS FRONTAL INFERIOR IZQUIERDO	Peso : 0,340 kg / 0.750 lb Tipo de Material : Chapa Metálica	54500-D7000, 54500-F1000
	<b>HY11062</b> Buje De Horquilla & Tijera	Chasis (Delantero / Trasero) : Trasera Posicion : Peso : 0.22 kg / 0.485 lb	54551-3R000, 54551-C5000

**SPORTAGE** **SL** **2010 - 2015**

Imagen	Clave del Producto y Descripción	Detalles	OEM
	<b>HY9010</b> Horquilla & Tijera	Peso : 0,650 kg / 1.433 lb Tipo de Material : Acero Forjado	55250-1D000, 55250-2S000
	<b>KI9004</b> Horquilla & Tijera	Peso : 1,242 kg / 2.738 lb Tipo de Material : Chapa Metálica	551002S050, 551003Q000 551003R000, 551003R050 551004Z100

**STONIC** **2018 -**

Imagen	Clave del Producto y Descripción	Detalles	OEM
	<b>KI2025</b> Terminal Exterior	Peso : 0,120 kg / 0.265 lb Longitud : 454 mm / 17.87 inch	56825-H8000
	<b>KI2026</b> Terminal Exterior	Peso : 0,120 kg / 0.265 lb Longitud : 454 mm / 17.87 inch	56820-H8000

**RIW<sup>®</sup>**

**LADA**





**VESTA**
**2015 -**

Imagen	Clave del Producto y Descripción	Detalles	OEM
	<b>LD6001</b> Horquilla & Tijera	Peso : 3.794 kg / 8.364 lb Tipo de Material : Chapa Metálica	8450006732
	<b>LD6002</b> Horquilla & Tijera	Peso : 3.794 kg / 8.364 lb Tipo de Material : Chapa Metálica	8450006733
	<b>LD11001</b> Buje De Horquilla & Tijera	Chasis (Delantero / Trasero) : Delantero Peso : 0.143 kg / 0.315 lb	Part Of 8450006732
	<b>LD11002</b> Buje De Horquilla & Tijera	Chasis (Delantero / Trasero) : Delantero Peso : 0.106 kg / 0.234 lb	Part Of 8450006732

**RIW<sup>®</sup>**

**LAMBORGHINI**

**URUS**
**2018 -**

Imagen	Clave del Producto y Descripción	Detalles	OEM
	<b>AU1022</b> Rotula	Peso : 0,580 kg / 1.279 lb	4M0407689B, 4M0407689C
	<b>AU5075</b> Horquilla & Tijera	Peso : 0.55 kg / 1.213 lb Tipo de Material : Aluminio	4M0407510B, 4M0407510C 80A407510A
	<b>AU5076</b> Horquilla & Tijera	Peso : 0.55 kg / 1.213 lb Tipo de Material : Aluminio	4M0407509B, 4M0407509C 80A407509A
	<b>AU5077</b> Horquilla & Tijera	Peso : 0.56 kg / 1.235 lb Tipo de Material : Aluminio	4M0407506B, 4M0407506C 80A407506A
	<b>AU5078</b> Horquilla & Tijera	Peso : 0.56 kg / 1.235 lb Tipo de Material : Aluminio	4M0407505B, 4M0407505C 80A407505A



**RIW<sup>®</sup>**

**LANCIA**

**FI8007 / Kit De Suspensi?n Y Direccion**

**DEDRA**

**835**

**1989 - 1999**



**Piezas del Kit**

Imagen	RIW Codigo / Nombre	OEM	OEM	RIW Codigo / Nombre	Imagen
	<b>AF3001</b> Terminal Interior Delantero	9939675, 9941625 9944452, 9947361 9947368	60806355, 7591215 7678717, 9947436 9947438, 99474380 9950672	<b>FI2016</b> Terminal Exterior Frontal Derecho	
	<b>FI2017</b> Terminal Exterior Frontal Izquierdo	60806356, 7591216 7678718, 9947437 9947439, 9950671	12574521, 60570627 7601642, 7601643 7601647	<b>FI4002</b> Tornillo Estabilizador Delantero	
	<b>FI6015</b> Horquillas Frontal Inferior Izquierdo	46423822, 71747915 7777239, 82461081	46423823, 71747916 7777240, 82461082	<b>FI6016</b> Horquillas Frontal Derecho Inferior	

\* Nombres de los vehiculos, marcas, modelos, simbolos y logos, numero OE y otros numeros de terceros en el sitio web y catalogo solo son con fines de referencia.

**RIW<sup>®</sup>**

**LAND ROVER**

**DISCOVERY III TAA 2004 - 2009**

Imagen	Clave del Producto y Descripción	Detalles	OEM
	<b>LR20083002</b> Terminales Completas	Peso : 1.373 kg / 3.027 lb Terminal Exterior : LR2008 Terminal Interior : LR3002	
	<b>LR10001</b> Buje De Horquilla & Tijera	Chasis (Delantero / Trasero) : Trasera Peso : 0,342 kg / 0.754 lb	LR019117*, RGD500083* RGD500190*

**DISCOVERY IV LA 2009 - 2016**

Imagen	Clave del Producto y Descripción	Detalles	OEM
	<b>LR10001</b> Buje De Horquilla & Tijera	Chasis (Delantero / Trasero) : Trasera Peso : 0,342 kg / 0.754 lb	LR019117*, RGD500083* RGD500190*

**DISCOVERY SPORT L550 2015 - 2019**

Imagen	Clave del Producto y Descripción	Detalles	OEM
	<b>LR20103005</b> Terminales Completas	Peso : 1,700 kg / 3.748 lb Terminal Exterior : LR2010 Terminal Interior : LR3005	
	<b>LR20113005</b> Terminales Completas	Peso : 1,700 kg / 3.748 lb Terminal Exterior : LR2011 Terminal Interior : LR3005	

**LR3 TAA 2004 - 2009**

Imagen	Clave del Producto y Descripción	Detalles	OEM
	<b>LR20083002</b> Terminales Completas	Peso : 1.373 kg / 3.027 lb Terminal Exterior : LR2008 Terminal Interior : LR3002	

**RANGE ROVER III LM, L322 2002 - 2012**

Imagen	Clave del Producto y Descripción	Detalles	OEM
	<b>LR20093004</b> Terminales Completas	Peso : 1,650 kg / 3.638 lb Terminal Exterior : LR2009 Terminal Interior : LR3004	

\* Nombres de los vehículos, marcas, modelos, símbolos y logos, número OE y otros números de terceros en el sitio web y catálogo solo son con fines de referencia.

**RANGE ROVER III LM, L322 2002 - 2012**

Imagen	Clave del Producto y Descripción	Detalles	OEM
	<b>LR10001</b> Buje De Horquilla & Tijera	Chasis (Delantero / Trasero) : Trasera Peso : 0,342 kg / 0.754 lb	LR019117*, RGD500083* RGD500190*
	<b>LR11019</b> Buje De Tornillo Estabilizador	Chasis (Delantero / Trasero) : Trasera Posicion : Izquierda Y Derecha Peso : 0.17 kg / 0.375 lb Longitud : LR4012 mm / 0.00 inch	RGD500100, RGD500180

**RANGE ROVER IV VOGUE L405 2012 - 2021**

Imagen	Clave del Producto y Descripción	Detalles	OEM
	<b>LR20123006</b> Terminales Completas	Peso : 1,400 kg / 3.086 lb Terminal Exterior : LR2012 Terminal Interior : LR3006	

**RANGE ROVER EVOQUE L538 2011 - 2018**

Imagen	Clave del Producto y Descripción	Detalles	OEM
	<b>LR20103005</b> Terminales Completas	Peso : 1,700 kg / 3.748 lb Terminal Exterior : LR2010 Terminal Interior : LR3005	
	<b>LR20113005</b> Terminales Completas	Peso : 1,700 kg / 3.748 lb Terminal Exterior : LR2011 Terminal Interior : LR3005	

**RANGE ROVER SPORT I LS, L320 2005 - 2013**

Imagen	Clave del Producto y Descripción	Detalles	OEM
	<b>LR9003</b> Horquilla & Tijera	Peso : 6,006 kg / 13.241 lb Tipo de Material : Chapa Metálica	LR010523, LR010526 LR051622, LR063719 RGG500283, RGG500440 RGG500500
	<b>LR9004</b> Horquilla & Tijera	Peso : 6,006 kg / 13.241 lb Tipo de Material : Chapa Metálica	LR010525, LR010527 LR051623, LR063718 RGG500293, RGG500450 RGG500510

**RANGE ROVER SPORT II LW, L494 2013 - 2022**

Imagen	Clave del Producto y Descripción	Detalles	OEM
	<b>LR20123006</b> Terminales Completas	Peso : 1,400 kg / 3.086 lb Terminal Exterior : LR2012 Terminal Interior : LR3006	

**RANGE ROVER VELAR L560 2017 -**

Imagen	Clave del Producto y Descripción	Detalles	OEM
	<b>JG6006</b> Horquilla & Tijera	Peso : 1,160 kg / 2.557 lb Tipo de Material : Aluminio	HK833084AB, HK833084BB T4A1010, T4A1067
	<b>JG6007</b> Horquilla & Tijera	Peso : 1,160 kg / 2.557 lb Tipo de Material : Aluminio	HK833091AB, HK833091BB T4A1068, T4A1069

**RIW<sup>®</sup>**

**LEXUS**

CT		200h		2011 - 2017	
Imagen	Clave del Producto y Descripción	Detalles	OEM		
	<b>TO9016</b> Horquilla & Tijera	Peso : 1,440 kg / 3.175 lb Tipo de Material : Chapa Metálica	4877012010		





  

ES		300		1992 - 1996	
Imagen	Clave del Producto y Descripción	Detalles	OEM		
	<b>TO20023830</b> Terminales Completas	Peso : 1,050 kg / 2.315 lb Terminal Exterior : TO2002 Terminal Interior : TO3830			

  





ES		300		1997 - 2001	
Imagen	Clave del Producto y Descripción	Detalles	OEM		
	<b>TO20023830</b> Terminales Completas	Peso : 1,050 kg / 2.315 lb Terminal Exterior : TO2002 Terminal Interior : TO3830			

ES		350		2007 - 2012	
Imagen	Clave del Producto y Descripción	Detalles	OEM		
	<b>TO9015</b> Horquilla & Tijera	Peso : 0,830 kg / 1.830 lb Tipo de Material : Tubo De Acero	4871006110, 4871006130 4871007010, 4871033130		
	<b>TO9017</b> Horquilla & Tijera	Peso : 1,280 kg / 2.822 lb Tipo de Material : Tubo De Acero	4873007040, 4873033100		
	<b>TO9018</b> Horquilla & Tijera	Peso : 1,280 kg / 2.822 lb Tipo de Material : Tubo De Acero	4874007020, 4874033100		
	<b>TO10001</b> Buje De Horquilla & Tijera	Chasis (Delantero / Trasero) : Trasera Posicion : Inferior Peso : 0.169 kg / 0.373 lb	Part of 4871006040, Part of 4871006120 Part of 4873007020, Part of 4873007040 Part of 4873033110		



GS		F	2016 - 2018
Imagen	Clave del Producto y Descripción	Detalles	OEM
	<b>LX1003</b> Rotula	Peso : 0,689 kg / 1.519 lb	4333039635

GS		L10	2011 - 2020
Imagen	Clave del Producto y Descripción	Detalles	OEM
	<b>LX1003</b> Rotula	Peso : 0,689 kg / 1.519 lb	4333039635
	<b>LX2003</b> Terminal Exterior	Peso : 1,004 kg / 2.213 lb Longitud : 211 mm / 8.31 inch	4546039715
	<b>LX2004</b> Terminal Exterior	Peso : 1,004 kg / 2.213 lb Longitud : 211 mm / 8.31 inch	4547039255
	<b>LX4016</b> Tornillo Estabilizador	Peso : 0,369 kg / 0.814 lb Tipo de Material : Metal Longitud : 135 mm / 5.31 inch	48830-30100
	<b>LX4017</b> Tornillo Estabilizador	Peso : 0,369 kg / 0.814 lb Tipo de Material : Metal Longitud : 135 mm / 5.31 inch	48840-30030

GS		S-160	1997 - 2004
Imagen	Clave del Producto y Descripción	Detalles	OEM
	<b>LX1001</b> Rotula	Peso : 0,998 kg / 2.200 lb	4333039455, 4333039535
	<b>LX1002</b> Rotula	Peso : 0,998 kg / 2.200 lb	4334039345, 4334039415
	<b>LX3003</b> Terminal interior	Peso : 0,504 kg / 1.111 lb Longitud : 222,5 mm / 8.76 inch	4550339155

\* Nombres de los vehículos, marcas, modelos, símbolos y logos, número OE y otros números de terceros en el sitio web y catálogo solo son con fines de referencia.

**GS S-190 2005 - 2011**

Imagen	Clave del Producto y Descripción	Detalles	OEM
	<b>LX1003</b> Rotula	Peso : 0,689 kg / 1.519 lb	4333039635
	<b>LX2003</b> Terminal Exterior	Peso : 1,004 kg / 2.213 lb Longitud : 211 mm / 8.31 inch	4546039715
	<b>LX2004</b> Terminal Exterior	Peso : 1,004 kg / 2.213 lb Longitud : 211 mm / 8.31 inch	4547039255

**GX J12 2001 - 2009**





Imagen	Clave del Producto y Descripción	Detalles	OEM
	<b>TO1057</b> Rotula	Peso : 0,663 kg / 1.462 lb	4806860040*, 4806960040*





**HS 250H 2010 - 2012**

Imagen	Clave del Producto y Descripción	Detalles	OEM
	<b>TO9016</b> Horquilla & Tijera	Peso : 1,440 kg / 3.175 lb Tipo de Material : Chapa Metálica	4877012010

**IS F 2008 - 2014**

Imagen	Clave del Producto y Descripción	Detalles	OEM
	<b>LX4020</b> Tornillo Estabilizador	Peso : 0,371 kg / 0.818 lb Tipo de Material : Metal Longitud : 71 mm / 2.80 inch Diámetro de Cuerda del Perno : M12X1,25	4882053010
	<b>LX4021</b> Tornillo Estabilizador	Peso : 0,371 kg / 0.818 lb Tipo de Material : Metal Longitud : 71 mm / 2.80 inch Diámetro de Cuerda del Perno : M12X1,25	4881053010

IS		II XE20		2006 - 2013	
Imagen	Clave del Producto y Descripción	Detalles	OEM		
	<b>LX1003</b> Rotula	Peso : 0,689 kg / 1.519 lb	4333039635		
	<b>LX2003</b> Terminal Exterior	Peso : 1,004 kg / 2.213 lb Longitud : 211 mm / 8.31 inch	4546039715		
	<b>LX2004</b> Terminal Exterior	Peso : 1,004 kg / 2.213 lb Longitud : 211 mm / 8.31 inch	4547039255		
	<b>LX4020</b> Tornillo Estabilizador	Peso : 0,371 kg / 0.818 lb Tipo de Material : Metal Longitud : 71 mm / 2.80 inch Diámetro de Cuerda del Perno : M12X1,25	4882053010		
	<b>LX4021</b> Tornillo Estabilizador	Peso : 0,371 kg / 0.818 lb Tipo de Material : Metal Longitud : 71 mm / 2.80 inch Diámetro de Cuerda del Perno : M12X1,25	4881053010		

IS		III XE30		2014 - 2020	
Imagen	Clave del Producto y Descripción	Detalles	OEM		
	<b>LX1003</b> Rotula	Peso : 0,689 kg / 1.519 lb	4333039635		
	<b>LX2003</b> Terminal Exterior	Peso : 1,004 kg / 2.213 lb Longitud : 211 mm / 8.31 inch	4546039715		
	<b>LX2004</b> Terminal Exterior	Peso : 1,004 kg / 2.213 lb Longitud : 211 mm / 8.31 inch	4547039255		
	<b>LX4016</b> Tornillo Estabilizador	Peso : 0,369 kg / 0.814 lb Tipo de Material : Metal Longitud : 135 mm / 5.31 inch	48830-30100		
	<b>LX4017</b> Tornillo Estabilizador	Peso : 0,369 kg / 0.814 lb Tipo de Material : Metal Longitud : 135 mm / 5.31 inch	48840-30030		

\* Nombres de los vehículos, marcas, modelos, símbolos y logos, número OE y otros números de terceros en el sitio web y catálogo solo son con fines de referencia.

LX		J100		1998 - 2008
Imagen	Clave del Producto y Descripción	Detalles	OEM	
	<b>TO4078</b> Tornillo Estabilizador	Peso : 0,221 kg / 0.487 lb Longitud : 128,2 mm / 5.05 inch	4880260090	

LX		J200		2007 -
Imagen	Clave del Producto y Descripción	Detalles	OEM	
	<b>TO4074</b> Tornillo Estabilizador	Peso : 0,618 kg / 1.362 lb Tipo de Material : Metal Longitud : 95 mm / 3.74 inch	48820-60070, 48820-60071	
	<b>TO4075</b> Tornillo Estabilizador	Peso : 0,618 kg / 1.362 lb Tipo de Material : Metal Longitud : 95 mm / 3.74 inch	48810-60050, 48810-60051	

NX		AAZH26		2021 -
Imagen	Clave del Producto y Descripción	Detalles	OEM	
	<b>TO11045</b> Buje De Horquilla & Tijera	Chasis (Delantero / Trasero) : Trasera Posicion : Peso : 0,194 kg / 0.428 lb	PART OF 48770-F4010, PART OF 48790-F4010	

NX		ZGZ1, AGZ1, AYZ1		2014 - 2021
Imagen	Clave del Producto y Descripción	Detalles	OEM	
	<b>TO9011</b> Horquilla & Tijera	Peso : 1,434 kg / 3.161 lb Tipo de Material : Chapa Metálica	4877042040	
	<b>TO9012</b> Horquilla & Tijera	Peso : 1,434 kg / 3.161 lb Tipo de Material : Chapa Metálica	4879042020	

RC		C1		2015 -
Imagen	Clave del Producto y Descripción	Detalles	OEM	
	<b>LX1003</b> Rotula	Peso : 0,689 kg / 1.519 lb	4333039635	

\* Nombres de los vehículos, marcas, modelos, símbolos y logos, número OE y otros números de terceros en el sitio web y catálogo solo son con fines de referencia.

RC		C1		2015 -	
Imagen	Clave del Producto y Descripción	Detalles	OEM		
	<b>LX4016</b> Tornillo Estabilizador	Peso : 0,369 kg / 0.814 lb Tipo de Material : Metal Longitud : 135 mm / 5.31 inch	48830-30100		
	<b>LX4017</b> Tornillo Estabilizador	Peso : 0,369 kg / 0.814 lb Tipo de Material : Metal Longitud : 135 mm / 5.31 inch	48840-30030		



RC		F		2015 - 2024	
Imagen	Clave del Producto y Descripción	Detalles	OEM		
	<b>LX1003</b> Rotula	Peso : 0,689 kg / 1.519 lb	4333039635		

RX		270		2009 - 2015	
Imagen	Clave del Producto y Descripción	Detalles	OEM		
	<b>TO6079J</b> Horquilla & Tijera	Peso : 3.82 kg / 8.422 lb Tipo de Material : Chapa Metálica	48068-0T011		
	<b>TO6080J</b> Horquilla & Tijera	Peso : 3.82 kg / 8.422 lb Tipo de Material : Chapa Metálica	48069-0T011		

RX		300		1997 - 2003	
Imagen	Clave del Producto y Descripción	Detalles	OEM		
	<b>TO4076</b> Tornillo Estabilizador	Peso : 0,306 kg / 0.675 lb Tipo de Material : Metal Longitud : 250 mm / 9.84 inch	48830-32040		

RX		350		2010 - 2015	
Imagen	Clave del Producto y Descripción	Detalles	OEM		
	<b>LX4018</b> Tornillo Estabilizador	Peso : 0,351 kg / 0.774 lb Tipo de Material : Metal Longitud : 90 mm / 3.54 inch	48802-48020		

\* Nombres de los vehículos, marcas, modelos, símbolos y logos, número OE y otros números de terceros en el sitio web y catálogo solo son con fines de referencia.

RX		350		2010 - 2015	
Imagen	Clave del Producto y Descripción	Detalles	OEM		
	<b>LX4019</b> Tornillo Estabilizador	Peso : 0,351 kg / 0.774 lb Tipo de Material : Metal Longitud : 90 mm / 3.54 inch	48803-48020		
	<b>TO6079J</b> Horquilla & Tijera	Peso : 3.82 kg / 8.422 lb Tipo de Material : Chapa Metálica	48068-0T011		
	<b>TO6080J</b> Horquilla & Tijera	Peso : 3.82 kg / 8.422 lb Tipo de Material : Chapa Metálica	48069-0T011		

RX		350		2016 - 2022	
Imagen	Clave del Producto y Descripción	Detalles	OEM		
	<b>TO6079J</b> Horquilla & Tijera	Peso : 3.82 kg / 8.422 lb Tipo de Material : Chapa Metálica	48068-0T011		
	<b>TO6080J</b> Horquilla & Tijera	Peso : 3.82 kg / 8.422 lb Tipo de Material : Chapa Metálica	48069-0T011		

RX		450H		2010 - 2015	
Imagen	Clave del Producto y Descripción	Detalles	OEM		
	<b>LX4018</b> Tornillo Estabilizador	Peso : 0,351 kg / 0.774 lb Tipo de Material : Metal Longitud : 90 mm / 3.54 inch	48802-48020		
	<b>LX4019</b> Tornillo Estabilizador	Peso : 0,351 kg / 0.774 lb Tipo de Material : Metal Longitud : 90 mm / 3.54 inch	48803-48020		
	<b>TO6079J</b> Horquilla & Tijera	Peso : 3.82 kg / 8.422 lb Tipo de Material : Chapa Metálica	48068-0T011		
	<b>TO6080J</b> Horquilla & Tijera	Peso : 3.82 kg / 8.422 lb Tipo de Material : Chapa Metálica	48069-0T011		

\* Nombres de los vehículos, marcas, modelos, símbolos y logos, número OE y otros números de terceros en el sitio web y catálogo solo son con fines de referencia.

**SC** **Z40** **2001 - 2010**

Imagen	Clave del Producto y Descripción	Detalles	OEM
	<p><b>LX1001</b> Rotula</p>	<p>Peso : 0,998 kg / 2.200 lb</p>	<p>4333039455, 4333039535</p>
	<p><b>LX1002</b> Rotula</p>	<p>Peso : 0,998 kg / 2.200 lb</p>	<p>4334039345, 4334039415</p>

\* Nombres de los vehiculos, marcas, modelos, simbolos y logos, numero OE y otros numeros de terceros en el sitio web y catalogo solo son con fines de referencia.

**RIW<sup>®</sup>**

**LINCOLN**





**AVIATOR**
**2003 - 2005**

Imagen	Clave del Producto y Descripción	Detalles	OEM
	<b>LC2001</b> Terminal Exterior	Peso : 1,369 kg / 3.018 lb Longitud : 585 mm / 23.03 inch	1L2Z5A972AB, 2L2Z5A972AA
	<b>LC2002</b> Terminal Exterior		1L2Z5A972AB, 2L2Z5A972AA
	<b>LC20012002</b> Terminales Completas	Peso : 1,743 kg / 3.843 lb Terminal Exterior : LC2001 Terminal Interior : LC2002	1L2Z5A972AB*, 2L2Z5A972AA*

**BLACKWOOD**
**2002 -**

Imagen	Clave del Producto y Descripción	Detalles	OEM
	<b>FO2085</b> Terminal Exterior	Peso : 0,730 kg / 1.609 lb Longitud : 166 mm / 6.54 inch	2L3Z3A130AA, F65Z3A130AA
	<b>FO2086</b> Terminal Exterior	Peso : 0,730 kg / 1.609 lb Longitud : 166 mm / 6.54 inch	2L3Z3A130BA, F65Z3A130BA

**CONTINENTAL**
**IX**
**1995 - 2002**

Imagen	Clave del Producto y Descripción	Detalles	OEM
	<b>FO1053</b> Rotula	Peso : 0,354 kg / 0.780 lb	5F1Z3050A, 5F1Z3V050A F5OY3K185A, F5OY3K186A F6DZ3K185A, F6DZ3K186A XF1Z3050AA
	<b>FO4073</b> Tornillo Estabilizador	Peso : 0,494 kg / 1.089 lb Tipo de Material : Metal Longitud : 272 mm / 10.71 inch	1F1Z5K484AA, 1F1Z5K484BA 2F1Z5K484BA, 3F1Z5K484A 3F1Z5K484AA, F5Y05K484A F5Y05K484A
	<b>FO4074</b> Tornillo Estabilizador	Peso : 0,494 kg / 1.089 lb Tipo de Material : Metal Longitud : 272 mm / 10.71 inch	1F1Z5K483AA, 1F1Z5K483BA 3F1Z5K483A, 3F1Z5K483AA F5Y05K483A, F7OZ5K483AA F7OZ5K483AA

\* Nombres de los vehículos, marcas, modelos, símbolos y logos, número OE y otros números de terceros en el sitio web y catálogo solo son con fines de referencia.

**CONTINENTAL V 1970 - 1979**

Imagen	Clave del Producto y Descripción	Detalles	OEM
	<b>CV4056</b> Tornillo Estabilizador	Peso : 0,182 kg / 0.401 lb Longitud : 195,5 mm / 7.70 inch	25784241



**CONTINENTAL VI 1980 - 1981**

Imagen	Clave del Producto y Descripción	Detalles	OEM
	<b>FO2077</b> TERMINAL EXTERIOR FRONTAL EXTERIOR	Peso : 0,450 kg / 0.992 lb Longitud : 71,1 mm / 2.80 inch	2W7Z3A130A, 2W7Z3A130AA D9AZ3A130A, F3AZ3A130A F5AZ3A130A
	<b>FO2089</b> Terminal Exterior	Peso : 0,561 kg / 1.237 lb Longitud : 165 mm / 6.50 inch	2W7Z3A131A, 2W7Z3A131AA D9AZ3A131A, F5AZ3A131A

**CONTINENTAL VII 1982 - 1987**

Imagen	Clave del Producto y Descripción	Detalles	OEM
	<b>FO4079</b> Tornillo Estabilizador	Peso : 0,276 kg / 0.608 lb Longitud : 288 mm / 11.34 inch	E6DZ5A486A, E9DZ5A486A
	<b>FO4080</b> Tornillo Estabilizador	Peso : 0,322 kg / 0.710 lb Longitud : 233,5 mm / 9.19 inch	D8BZ5A486A, E6LY5A486A E6ZZ5A486A, F1ZZ5A486A

**CONTINENTAL VIII 1988 - 1994**

Imagen	Clave del Producto y Descripción	Detalles	OEM
	<b>FO3052</b> Terminal interior	Peso : 0,583 kg / 1.285 lb Longitud : 338 mm / 13.31 inch	E6DZ3280A, F6SZ3280BA
	<b>FO4076</b> Tornillo Estabilizador	Peso : 0,478 kg / 1.054 lb Tipo de Material : Metal Longitud : 265 mm / 10.43 inch Diámetro de Cuerda del Perno : M12X1,75	E6DZ5K484A, F4DZ5K484A F78Z5K483AA
	<b>FO4079</b> Tornillo Estabilizador	Peso : 0,276 kg / 0.608 lb Longitud : 288 mm / 11.34 inch	E6DZ5A486A, E9DZ5A486A

\* Nombres de los vehículos, marcas, modelos, símbolos y logos, número OE y otros números de terceros en el sitio web y catálogo solo son con fines de referencia.

**CONTINENTAL X 2017 - 2020**

Imagen	Clave del Producto y Descripción	Detalles	OEM
	<b>FO9030</b> Horquilla & Tijera	Peso : 1,049 kg / 2.313 lb Tipo de Material : Chapa Metálica	E1GZ5K898A, FR3Z5K898A FR3Z5K898B, G3GZ5K898A

**MARK III 1969 - 1971**

Imagen	Clave del Producto y Descripción	Detalles	OEM
	<b>CV4056</b> Tornillo Estabilizador	Peso : 0,182 kg / 0.401 lb Longitud : 195,5 mm / 7.70 inch	25784241

**MARK IV 1972 - 1976**

Imagen	Clave del Producto y Descripción	Detalles	OEM
	<b>CV4056</b> Tornillo Estabilizador	Peso : 0,182 kg / 0.401 lb Longitud : 195,5 mm / 7.70 inch	25784241

**MARK V 1977 - 1979**

Imagen	Clave del Producto y Descripción	Detalles	OEM
	<b>CV4056</b> Tornillo Estabilizador	Peso : 0,182 kg / 0.401 lb Longitud : 195,5 mm / 7.70 inch	25784241

**MARK VI 1980 - 1983**

Imagen	Clave del Producto y Descripción	Detalles	OEM
	<b>FO2077</b> TERMINAL EXTERIOR FRONTAL EXTERIOR	Peso : 0,450 kg / 0.992 lb Longitud : 71,1 mm / 2.80 inch	2W7Z3A130A, 2W7Z3A130AA D9AZ3A130A, F3AZ3A130A F5AZ3A130A
	<b>FO2089</b> Terminal Exterior	Peso : 0,561 kg / 1.237 lb Longitud : 165 mm / 6.50 inch	2W7Z3A131A, 2W7Z3A131AA D9AZ3A131A, F5AZ3A131A
	<b>CV4056</b> Tornillo Estabilizador	Peso : 0,182 kg / 0.401 lb Longitud : 195,5 mm / 7.70 inch	25784241

\* Nombres de los vehículos, marcas, modelos, símbolos y logos, número OE y otros números de terceros en el sitio web y catálogo solo son con fines de referencia.

**MARK VII 1984 - 1992**

Imagen	Clave del Producto y Descripción	Detalles	OEM
	<b>FO4079</b> Tornillo Estabilizador	Peso : 0,276 kg / 0.608 lb Longitud : 288 mm / 11.34 inch	E6DZ5A486A, E9DZ5A486A
	<b>FO4080</b> Tornillo Estabilizador	Peso : 0,322 kg / 0.710 lb Longitud : 233,5 mm / 9.19 inch	D8BZ5A486A, E6LY5A486A E6ZZ5A486A, F1ZZ5A486A

**MARK VIII 1980 - 1983**

Imagen	Clave del Producto y Descripción	Detalles	OEM
	<b>FO3052</b> Terminal interior	Peso : 0,583 kg / 1.285 lb Longitud : 338 mm / 13.31 inch	E6DZ3280A, F6SZ3280BA

**MARK LT 2005 - 2008**

Imagen	Clave del Producto y Descripción	Detalles	OEM
	<b>FO2078</b> TERMINAL EXTERIOR FRONTAL EXTERIOR	Peso : 0,598 kg / 1.318 lb Longitud : 115 mm / 4.53 inch	4L3Z3A130CA





**MKX 2016 - 2018**

Imagen	Clave del Producto y Descripción	Detalles	OEM
	<b>FO9030</b> Horquilla & Tijera	Peso : 1,049 kg / 2.313 lb Tipo de Material : Chapa Metálica	E1GZ5K898A, FR3Z5K898A FR3Z5K898B, G3GZ5K898A



**MKZ I 2006 - 2012**

Imagen	Clave del Producto y Descripción	Detalles	OEM
	<b>FO3054</b> Terminal interior	Peso : 0,407 kg / 0.897 lb Longitud : 179 mm / 7.05 inch Tamaño de la Rosca : M14X1,5 Diámetro de Cuerda del Perno : M14X1,5	AE5Z3280A

**MKZ II 2013 - 2020**

Imagen	Clave del Producto y Descripción	Detalles	OEM
	<b>FO9027</b> Horquilla & Tijera	Peso : 0,756 kg / 1.667 lb Tipo de Material : Tubo De Acero	DG9Z5A972B
	<b>FO11079</b> Buje De Horquilla & Tijera	Chasis (Delantero / Trasero) : Delantero Posicion : Inferior Chico Peso : 0.558 kg / 1.230 lb	1927131*, 1927132* 5232480*, 5232481* 5303328*, 5303329* FG9C-3A052-ANA*, FG9C-3A053-ANA*
	<b>FO11080</b> Buje De Horquilla & Tijera	Chasis (Delantero / Trasero) : Delantero Posicion : Inferior Derecho Grande Otro Lado del Artículo : FO11081 Peso : 1.788 kg / 3.942 lb	1927131*, 5232480* 5303328*, FG9C-3A052-ANA*
	<b>FO11081</b> Buje De Horquilla & Tijera	Chasis (Delantero / Trasero) : Delantero Posicion : Inferior Izquierda Grande Otro Lado del Artículo : FO11080 Peso : 1.788 kg / 3.942 lb	1927132*, 5232481* 5303329*, FG9C-3A053-ANA*

**NAVIGATOR I 1998 - 2002**

Imagen	Clave del Producto y Descripción	Detalles	OEM
	<b>FO2085</b> Terminal Exterior	Peso : 0,730 kg / 1.609 lb Longitud : 166 mm / 6.54 inch	2L3Z3A130AA, F65Z3A130AA
	<b>FO2086</b> Terminal Exterior	Peso : 0,730 kg / 1.609 lb Longitud : 166 mm / 6.54 inch	2L3Z3A130BA, F65Z3A130BA
	<b>FO4078</b> Tornillo Estabilizador	Peso : 0,762 kg / 1.680 lb Longitud : 381 mm / 15.00 inch	YL1Z5K484AA

**NAVIGATOR II 2003 - 2006**

Imagen	Clave del Producto y Descripción	Detalles	OEM
	<b>FO6134</b> Horquilla & Tijera	Peso : 3,500 kg / 7.716 lb Tipo de Material : Acero Forjado	4L1Z3084CA, 6L1Z3084BA
	<b>FO6135</b> Horquilla & Tijera	Peso : 3,500 kg / 7.716 lb Tipo de Material : Acero Forjado	4L1Z3085CA, 6L1Z3085BA

\* Nombres de los vehículos, marcas, modelos, símbolos y logos, número OE y otros números de terceros en el sitio web y catálogo solo son con fines de referencia.

**TOWN CAR**
**1981 - 1990**

Imagen	Clave del Producto y Descripción	Detalles	OEM
	<b>FO2077</b> TERMINAL EXTERIOR FRONTAL EXTERIOR	Peso : 0,450 kg / 0.992 lb Longitud : 71,1 mm / 2.80 inch	2W7Z3A130A, 2W7Z3A130AA D9AZ3A130A, F3AZ3A130A F5AZ3A130A
	<b>FO2089</b> Terminal Exterior	Peso : 0,561 kg / 1.237 lb Longitud : 165 mm / 6.50 inch	2W7Z3A131A, 2W7Z3A131AA D9AZ3A131A, F5AZ3A131A
	<b>CV4056</b> Tornillo Estabilizador	Peso : 0,182 kg / 0.401 lb Longitud : 195,5 mm / 7.70 inch	25784241

**TOWN CAR**
**1991 - 1994**

Imagen	Clave del Producto y Descripción	Detalles	OEM
	<b>FO2077</b> TERMINAL EXTERIOR FRONTAL EXTERIOR	Peso : 0,450 kg / 0.992 lb Longitud : 71,1 mm / 2.80 inch	2W7Z3A130A, 2W7Z3A130AA D9AZ3A130A, F3AZ3A130A F5AZ3A130A
	<b>FO2089</b> Terminal Exterior	Peso : 0,561 kg / 1.237 lb Longitud : 165 mm / 6.50 inch	2W7Z3A131A, 2W7Z3A131AA D9AZ3A131A, F5AZ3A131A

**TOWN CAR**
**1995 - 1997**

Imagen	Clave del Producto y Descripción	Detalles	OEM
	<b>FO2077</b> TERMINAL EXTERIOR FRONTAL EXTERIOR	Peso : 0,450 kg / 0.992 lb Longitud : 71,1 mm / 2.80 inch	2W7Z3A130A, 2W7Z3A130AA D9AZ3A130A, F3AZ3A130A F5AZ3A130A
	<b>FO2089</b> Terminal Exterior	Peso : 0,561 kg / 1.237 lb Longitud : 165 mm / 6.50 inch	2W7Z3A131A, 2W7Z3A131AA D9AZ3A131A, F5AZ3A131A

**TOWN CAR**
**1998 - 2002**

Imagen	Clave del Producto y Descripción	Detalles	OEM
	<b>FO2077</b> TERMINAL EXTERIOR FRONTAL EXTERIOR	Peso : 0,450 kg / 0.992 lb Longitud : 71,1 mm / 2.80 inch	2W7Z3A130A, 2W7Z3A130AA D9AZ3A130A, F3AZ3A130A F5AZ3A130A

\* Nombres de los vehículos, marcas, modelos, símbolos y logos, número OE y otros números de terceros en el sitio web y catálogo solo son con fines de referencia.

**TOWN CAR**
**1998 - 2002**

Imagen	Clave del Producto y Descripción	Detalles	OEM
	<b>FO2089</b> Terminal Exterior	Peso : 0,561 kg / 1.237 lb Longitud : 165 mm / 6.50 inch	2W7Z3A131A, 2W7Z3A131AA D9AZ3A131A, F5AZ3A131A
	<b>FO4077</b> Tornillo Estabilizador	Peso : 0,401 kg / 0.884 lb Tipo de Material : Metal Longitud : 160 mm / 6.30 inch	F5AZ5K484A, F5AZ6K484AA F8AZ5K484AA

**VERSAILLES**
**1977 - 1980**

Imagen	Clave del Producto y Descripción	Detalles	OEM
	<b>CD4005</b> Tornillo Estabilizador	Peso : 0,220 kg / 0.485 lb Longitud : 145 mm / 5.71 inch	25679063, 3879218

**RIW<sup>®</sup>**

**MAN**



**TGE UY, UZ 2016 -**

Imagen	Clave del Producto y Descripción	Detalles	OEM
	<p><b>VW1041</b> Rotula</p>	<p>Peso : 0,597 kg / 1.316 lb</p>	<p>2N0407361A</p>
	<p><b>VW11079</b> Buje De Tornillo Estabilizador</p>	<p>Chasis (Delantero / Trasero) : Trasera Posicion : Trasera Peso : 0.11 kg / 0.243 lb</p>	<p>2N0505465B*</p>

\* Nombres de los vehiculos, marcas, modelos, simbolos y logos, numero OE y otros numeros de terceros en el sitio web y catalogo solo son con fines de referencia.

**RIW<sup>®</sup>**

**MAZDA**

**2 DE 2008 - 2015**

Imagen	Clave del Producto y Descripción	Detalles	OEM
	<p><b>F113016K</b> Cubre Polvo De Direccion</p>	<p>Peso : 0.164 kg / 0.362 lb</p>	<p>4066.95, 77363828 77364571</p>

\* Nombres de los vehiculos, marcas, modelos, simbolos y logos, numero OE y otros numeros de terceros en el sitio web y catalogo solo son con fines de referencia.

**MZ8001 / Kit De Suspension Y Direccion**







**3**

**BK**

**2003 - 2009**



**Piezas del Kit**

Imagen	RIWCodigo / Nombre	OEM	OEM	RIWCodigo / Nombre	Imagen
	<b>MZ2006</b> Terminal Exterior Frontal Derecho	BP4L32280, BPL432280	BP4L32290	<b>MZ2007</b> Terminal Exterior Frontal Izquierdo	
	<b>MZ3011</b> Terminal Interior Delantero	BP4L32240	BP4K34170C	<b>MZ4015</b> Tornillo Estabilizador Delantero	
	<b>MZ6009</b> Horquillas Frontal Derecho Inferior	B32H34300, B32H34300A B32H34300B, B32H34300C B32H34300D, B32H34300E BP4K32300E, BP4K34300E C513343000	B32H34350, B32H34350A B32H34350B, B32H34350C B32H34350D, B32H34350E BP4K32350E, BP4K34350A BP4K34350B, BP4K34350E	<b>MZ6010</b> Horquillas Frontal Inferior Izquierdo	

\* Nombres de los vehiculos, marcas, modelos, simbolos y logos, numero OE y otros numeros de terceros en el sitio web y catalogo solo son con fines de referencia.

**MZ8001 / Kit De Suspension Y Direccion**







5

CR19

2005 - 2010



**Piezas del Kit**

Imagen	RIWCodigo / Nombre	OEM	OEM	RIWCodigo / Nombre	Imagen
	<b>MZ2006</b> Terminal Exterior Frontal Derecho	BP4L32280, BPL432280	BP4L32290	<b>MZ2007</b> Terminal Exterior Frontal Izquierdo	
	<b>MZ3011</b> Terminal Interior Delantero	BP4L32240	BP4K34170C	<b>MZ4015</b> Tornillo Estabilizador Delantero	
	<b>MZ6009</b> Horquillas Frontal Derecho Inferior	B32H34300, B32H34300A B32H34300B, B32H34300C B32H34300D, B32H34300E BP4K32300E, BP4K34300E C513343000	B32H34350, B32H34350A B32H34350B, B32H34350C B32H34350D, B32H34350E BP4K32350E, BP4K34350A BP4K34350B, BP4K34350E	<b>MZ6010</b> Horquillas Frontal Inferior Izquierdo	

\* Nombres de los vehiculos, marcas, modelos, simbolos y logos, numero OE y otros numeros de terceros en el sitio web y catalogo solo son con fines de referencia.

**MZ8002 / Kit De Suspension Y Direccion**







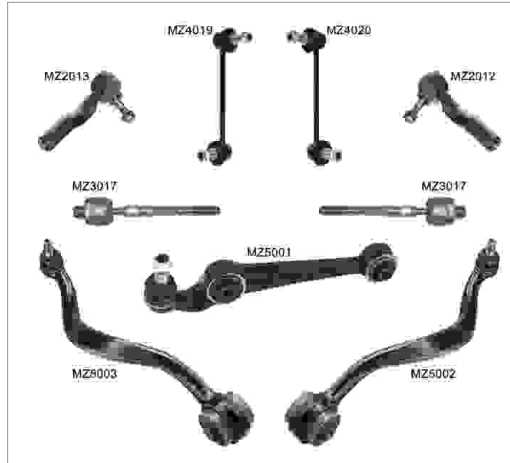

6

**GG**

**2002 - 2007**



**Piezas del Kit**

Imagen	RIWCodigo / Nombre	OEM	OEM	RIWCodigo / Nombre	Imagen
	<b>MZ2012</b> Terminal Exterior Frontal Derecho	G26A32280, GJ6E2280 GJ6E32280, GJ6E32280A	G26A32290, GJ6E32290 GJ6E32290A	<b>MZ2013</b> Terminal Exterior Frontal Izquierdo	
	<b>MZ3017</b> Terminal Interior Delantero	GJ6E32240	GJ6A34150A	<b>MZ4019</b> Tornillo Estabilizador Frontal Derecho	
	<b>MZ4020</b> Tornillo Estabilizador Frontal Izquierdo	GJ6A34170A	GJ6A34300B, GJ6A34300C GJ6A34300D, GJ6A34300E	<b>MZ5001</b> Horquillas Frontal Inferior	
	<b>MZ5002</b> Horquillas Frontal Derecho Inferior	5M8Z3078R, 6M8Z3078R 7E5Z3078RA, BE5Z3078B GJ6A34J00B, GJ6A34J00C GJ6A34J00D, GR1A34J00 GR1B34J00	5M8Z3079L, 6M8Z3079L 7E5Z3079L, BE5Z3079A GJ6A34J50B, GJ6A34J50C GJ6A34J50D, GR1A34J50 GR1B34J50	<b>MZ5003</b> Horquillas Frontal Inferior Izquierdo	

\* Nombres de los vehiculos, marcas, modelos, simbolos y logos, numero OE y otros numeros de terceros en el sitio web y catalogo solo son con fines de referencia.

**B-2500 UF 1995 - 1999**

Imagen	Clave del Producto y Descripción	Detalles	OEM
	<b>FO2091</b> Terminal Exterior	Peso : 0,433 kg / 0.955 lb Longitud : 84 mm / 3.31 inch Tamaño de la Rosca : M14X1,5 LHT Diámetro de Cuerda del Perno : M12X1,25	3669093, 8AU132280 UH7432280, XM343289BA

**B-2500 UN 1998 - 2006**

Imagen	Clave del Producto y Descripción	Detalles	OEM
	<b>FO2091</b> Terminal Exterior	Peso : 0,433 kg / 0.955 lb Longitud : 84 mm / 3.31 inch Tamaño de la Rosca : M14X1,5 LHT Diámetro de Cuerda del Perno : M12X1,25	3669093, 8AU132280 UH7432280, XM343289BA
	<b>FO2093</b> Terminal Exterior	Peso : 0,556 kg / 1.226 lb Longitud : 112 mm / 4.41 inch	5L5Z3A130AA, F87Z3A130BA ZZP032365, ZZP032365A

**B-3000 1998 - 2001**

Imagen	Clave del Producto y Descripción	Detalles	OEM
	<b>FO2093</b> Terminal Exterior	Peso : 0,556 kg / 1.226 lb Longitud : 112 mm / 4.41 inch	5L5Z3A130AA, F87Z3A130BA ZZP032365, ZZP032365A

**B-3000 2002 - 2007**

Imagen	Clave del Producto y Descripción	Detalles	OEM
	<b>FO2093</b> Terminal Exterior	Peso : 0,556 kg / 1.226 lb Longitud : 112 mm / 4.41 inch	5L5Z3A130AA, F87Z3A130BA ZZP032365, ZZP032365A

**B-4000 1998 - 2001**

Imagen	Clave del Producto y Descripción	Detalles	OEM
	<b>FO2093</b> Terminal Exterior	Peso : 0,556 kg / 1.226 lb Longitud : 112 mm / 4.41 inch	5L5Z3A130AA, F87Z3A130BA ZZP032365, ZZP032365A

**B-4000**
**2002 - 2004**

Imagen	Clave del Producto y Descripción	Detalles	OEM
	<b>FO2093</b> Terminal Exterior	Peso : 0,556 kg / 1.226 lb Longitud : 112 mm / 4.41 inch	5L5Z3A130AA, F87Z3A130BA ZZP032365, ZZP032365A

**BT-50 PICKUP**
**2006 - 2012**

Imagen	Clave del Producto y Descripción	Detalles	OEM
	<b>FO2079</b> TERMINAL EXTERIOR FRONTAL EXTERIOR	Peso : 0,410 kg / 0.904 lb Longitud : 84 mm / 3.31 inch Tamaño de la Rosca : M14X1,5 LHT Diámetro de Cuerda del Perno : M12X1,25	1454897, 6M343289AA UR5632280

**BT-50 PICKUP**
**2011 - 2015**

Imagen	Clave del Producto y Descripción	Detalles	OEM
	<b>FO2079</b> TERMINAL EXTERIOR FRONTAL EXTERIOR	Peso : 0,410 kg / 0.904 lb Longitud : 84 mm / 3.31 inch Tamaño de la Rosca : M14X1,5 LHT Diámetro de Cuerda del Perno : M12X1,25	1454897, 6M343289AA UR5632280
	<b>FO3051</b> Terminal interior	Peso : 0,516 kg / 1.138 lb Longitud : 202 mm / 7.95 inch Tamaño de la Rosca : M14X1,5 Diámetro de Cuerda del Perno : M14X1,5	1732879, 1775547 AB313280AA, AB313280AB UC2M3224X, UC2M3224XA

**CX-3**
**DK**
**2015 -**

Imagen	Clave del Producto y Descripción	Detalles	OEM
	<b>MZ6033</b> Horquilla & Tijera	Peso : 4,166 kg / 9.184 lb Tipo de Material : Chapa Metálica	D10E34300
	<b>MZ6034</b> Horquilla & Tijera	Peso : 4,166 kg / 9.184 lb Tipo de Material : Chapa Metálica	D10E34350

**MPV**
**II LW**
**1999 - 2006**

Imagen	Clave del Producto y Descripción	Detalles	OEM
	<b>MZ1021</b> Rotula	Peso : 0,341 kg / 0.752 lb	LC6234300C*, LC6234350C*

\* Nombres de los vehículos, marcas, modelos, símbolos y logos, número OE y otros números de terceros en el sitio web y catálogo solo son con fines de referencia.



**RIW<sup>®</sup>**

**MERCEDES**

**A CLASS W168 1997 - 2004**

Imagen	Clave del Producto y Descripción	Detalles	OEM
	<b>ME12030K</b> Soporte De Amortiguador	Posicion : Izquierda Y Derecha Peso : 0.95 kg / 2.094 lb Nota : AMORTISÖR SETİ RULMANLI	1683200056, 1683200373 A1683200373

**C CLASS W202 1993 - 2000**

Imagen	Clave del Producto y Descripción	Detalles	OEM
	<b>ME12059</b> Soporte De Transmision	Chasis (Delantero / Trasero) : Delantero Peso : 0,519 kg / 1.144 lb	1402401218, 1402401718 2122400318, 2202400118 2202400418, 5101457AA

**C CLASS W203 2000 - 2007**





Imagen	Clave del Producto y Descripción	Detalles	OEM
	<b>ME12061</b> Goma De Barra Estabilizadora	Chasis (Delantero / Trasero) : Delantero Peso : 0,110 kg / 0.243 lb Tipo de Material : Rubber	2033230585, 2033232185 A2033230585, A2033232185
	<b>ME12061K</b> Goma De Barra Estabilizadora	Chasis (Delantero / Trasero) : Delantero Peso : 0,220 kg / 0.485 lb Tipo de Material : Rubber Nota : 2 Pieces	2033230585, 2033232185 A2033230585, A2033232185
	<b>ME12059</b> Soporte De Transmision	Chasis (Delantero / Trasero) : Delantero Peso : 0,519 kg / 1.144 lb	1402401218, 1402401718 2122400318, 2202400118 2202400418, 5101457AA

**C CLASS W204 2007 - 2014**

Imagen	Clave del Producto y Descripción	Detalles	OEM
	<b>ME20493012</b> Terminales Completas	Peso : 1,350 kg / 2.976 lb Terminal Exterior : ME2049 Terminal Interior : ME3012	
	<b>ME20503012</b> Terminales Completas	Peso : 1,350 kg / 2.976 lb Terminal Exterior : ME2050 Terminal Interior : ME3012	
	<b>ME12059</b> Soporte De Transmision	Chasis (Delantero / Trasero) : Delantero Peso : 0,519 kg / 1.144 lb	1402401218, 1402401718 2122400318, 2202400118 2202400418, 5101457AA

\* Nombres de los vehiculos, marcas, modelos, simbolos y logos, numero OE y otros numeros de terceros en el sitio web y catalogo solo son con fines de referencia.

**C CLASS W205 2013 - 2020**

Imagen	Clave del Producto y Descripción	Detalles	OEM
	<b>ME1028</b> Rotula	Peso : 0,328 kg / 0.723 lb	2053305901*, 2053306001*
	<b>ME20553020</b> Terminales Completas	Peso : 1,600 kg / 3.527 lb Terminal Exterior : ME2055 Terminal Interior : ME3020	
	<b>ME20563020</b> Terminales Completas	Peso : 1,600 kg / 3.527 lb Terminal Exterior : ME2056 Terminal Interior : ME3020	
	<b>ME20623019</b> Terminales Completas	Peso : 1,630 kg / 3.594 lb Terminal Exterior : ME2062 Terminal Interior : ME3019	
	<b>ME20633019</b> Terminales Completas	Peso : 1,630 kg / 3.594 lb Terminal Exterior : ME2063 Terminal Interior : ME3019	

**CLC CLASS CL203 2008 - 2011**

Imagen	Clave del Producto y Descripción	Detalles	OEM
	<b>ME12061</b> Goma De Barra Estabilizadora	Chasis (Delantero / Trasero) : Delantero Peso : 0,110 kg / 0.243 lb Tipo de Material : Rubber	2033230585, 2033232185 A2033230585, A2033232185
	<b>ME12061K</b> Goma De Barra Estabilizadora	Chasis (Delantero / Trasero) : Delantero Peso : 0,220 kg / 0.485 lb Tipo de Material : Rubber Nota : 2 Pieces	2033230585, 2033232185 A2033230585, A2033232185
	<b>ME12059</b> Soporte De Transmision	Chasis (Delantero / Trasero) : Delantero Peso : 0,519 kg / 1.144 lb	1402401218, 1402401718 2122400318, 2202400118 2202400418, 5101457AA

**CLK A209, C209 2002 - 2009**





Imagen	Clave del Producto y Descripción	Detalles	OEM
	<b>ME12059</b> Soporte De Transmision	Chasis (Delantero / Trasero) : Delantero Peso : 0,519 kg / 1.144 lb	1402401218, 1402401718 2122400318, 2202400118 2202400418, 5101457AA

\* Nombres de los vehiculos, marcas, modelos, simbolos y logos, numero OE y otros numeros de terceros en el sitio web y catalogo solo son con fines de referencia.

**CLK W209 2002 - 2009**

Imagen	Clave del Producto y Descripción	Detalles	OEM
	<b>ME12061</b> Goma De Barra Estabilizadora	Chasis (Delantero / Trasero) : Delantero Peso : 0,110 kg / 0.243 lb Tipo de Material : Rubber	2033230585, 2033232185 A2033230585, A2033232185
	<b>ME12061K</b> Goma De Barra Estabilizadora	Chasis (Delantero / Trasero) : Delantero Peso : 0,220 kg / 0.485 lb Tipo de Material : Rubber Nota : 2 Pieces	2033230585, 2033232185 A2033230585, A2033232185

**CLS C218, X218 2011 - 2018**

Imagen	Clave del Producto y Descripción	Detalles	OEM
	<b>ME20683025</b> Terminales Completas	Peso : 1,150 kg / 2.535 lb Terminal Exterior : ME2068 Terminal Interior : ME3025	
	<b>ME20693025</b> Terminales Completas	Peso : 1,150 kg / 2.535 lb Terminal Exterior : ME2069 Terminal Interior : ME3025	
	<b>ME12062</b> Soporte De Amortiguador	Chasis (Delantero / Trasero) : Delantero Peso : 1,025 kg / 2.260 lb	2123230020, A2123230020
	<b>ME12059</b> Soporte De Transmision	Chasis (Delantero / Trasero) : Delantero Peso : 0,519 kg / 1.144 lb	1402401218, 1402401718 2122400318, 2202400118 2202400418, 5101457AA

**CLS C219 2004 - 2010**

Imagen	Clave del Producto y Descripción	Detalles	OEM
	<b>ME12059</b> Soporte De Transmision	Chasis (Delantero / Trasero) : Delantero Peso : 0,519 kg / 1.144 lb	1402401218, 1402401718 2122400318, 2202400118 2202400418, 5101457AA

**E CLASS W124 1984 - 1995**



Imagen	Clave del Producto y Descripción	Detalles	OEM
	<b>ME12059</b> Soporte De Transmision	Chasis (Delantero / Trasero) : Delantero Peso : 0,519 kg / 1.144 lb	1402401218, 1402401718 2122400318, 2202400118 2202400418, 5101457AA

\* Nombres de los vehículos, marcas, modelos, símbolos y logos, número OE y otros números de terceros en el sitio web y catálogo solo son con fines de referencia.





**E CLASS W210 1995 - 2003**

Imagen	Clave del Producto y Descripción	Detalles	OEM
	<b>ME11008K</b> Buje De Horquilla & Tijera	Chasis (Delantero / Trasero) : Delantero Posicion : Izquierda Y Derecha Peso : 0,276 kg / 0.608 lb Nota : 2 Pieces	2023338714, A2023338714
	<b>ME12059</b> Soporte De Transmision	Chasis (Delantero / Trasero) : Delantero Peso : 0,519 kg / 1.144 lb	1402401218, 1402401718 2122400318, 2202400118 2202400418, 5101457AA

**E CLASS W211 2003 - 2009**



Imagen	Clave del Producto y Descripción	Detalles	OEM
	<b>ME2074</b> Terminal Exterior	Peso : 1,328 kg / 2.928 lb Longitud : 189 mm / 7.44 inch	2203381415, A2203381415
	<b>ME2075</b> Terminal Exterior	Peso : 1,328 kg / 2.928 lb Longitud : 189 mm / 7.44 inch	2203381315, A2203381315
	<b>ME12059</b> Soporte De Transmision	Chasis (Delantero / Trasero) : Delantero Peso : 0,519 kg / 1.144 lb	1402401218, 1402401718 2122400318, 2202400118 2202400418, 5101457AA

**E CLASS W212 2009 - 2016**

Imagen	Clave del Producto y Descripción	Detalles	OEM
	<b>ME20683025</b> Terminales Completas	Peso : 1,150 kg / 2.535 lb Terminal Exterior : ME2068 Terminal Interior : ME3025	
	<b>ME20693025</b> Terminales Completas	Peso : 1,150 kg / 2.535 lb Terminal Exterior : ME2069 Terminal Interior : ME3025	
	<b>ME12062</b> Soporte De Amortiguador	Chasis (Delantero / Trasero) : Delantero Peso : 1,025 kg / 2.260 lb	2123230020, A2123230020
	<b>ME12059</b> Soporte De Transmision	Chasis (Delantero / Trasero) : Delantero Peso : 0,519 kg / 1.144 lb	1402401218, 1402401718 2122400318, 2202400118 2202400418, 5101457AA

\* Nombres de los vehiculos, marcas, modelos, simbolos y logos, numero OE y otros numeros de terceros en el sitio web y catalogo solo son con fines de referencia.





**E CLASS W213, S213 4X2 2016 - 2022**

Imagen	Clave del Producto y Descripción	Detalles	OEM
	<b>ME1028</b> Rotula	Peso : 0,328 kg / 0.723 lb	2053305901*, 2053306001*
	<b>ME20553020</b> Terminales Completas	Peso : 1,600 kg / 3.527 lb Terminal Exterior : ME2055 Terminal Interior : ME3020	
	<b>ME20563020</b> Terminales Completas	Peso : 1,600 kg / 3.527 lb Terminal Exterior : ME2056 Terminal Interior : ME3020	

**E CLASS W213, S213 4X4 2016 - 2022**

Imagen	Clave del Producto y Descripción	Detalles	OEM
	<b>ME20623019</b> Terminales Completas	Peso : 1,630 kg / 3.594 lb Terminal Exterior : ME2062 Terminal Interior : ME3019	
	<b>ME20633019</b> Terminales Completas	Peso : 1,630 kg / 3.594 lb Terminal Exterior : ME2063 Terminal Interior : ME3019	

**EQC N293 2019 -**

Imagen	Clave del Producto y Descripción	Detalles	OEM
	<b>ME20623019</b> Terminales Completas	Peso : 1,630 kg / 3.594 lb Terminal Exterior : ME2062 Terminal Interior : ME3019	
	<b>ME20633019</b> Terminales Completas	Peso : 1,630 kg / 3.594 lb Terminal Exterior : ME2063 Terminal Interior : ME3019	
	<b>ME4103</b> Tornillo Estabilizador	Peso : 1,010 kg / 2.227 lb Tipo de Material : Metal Longitud : 279 mm / 10.98 inch	2533230217, A2533230217
	<b>ME4104</b> Tornillo Estabilizador	Peso : 1,010 kg / 2.227 lb Tipo de Material : Metal Longitud : 279 mm / 10.98 inch	2533230117, A2533230117

\* Nombres de los vehículos, marcas, modelos, símbolos y logos, número OE y otros números de terceros en el sitio web y catálogo solo son con fines de referencia.





**G CLASS W461 1990 - 2001**

Imagen	Clave del Producto y Descripción	Detalles	OEM
	<b>ME12059</b> Soporte De Transmision	Chasis (Delantero / Trasero) : Delantero Peso : 0,519 kg / 1.144 lb	1402401218, 1402401718 2122400318, 2202400118 2202400418, 5101457AA

**GL CLASS X166 2012 -**

Imagen	Clave del Producto y Descripción	Detalles	OEM
	<b>ME20573024</b> Terminales Completas	Peso : 1,500 kg / 3.307 lb Terminal Exterior : ME2057 Terminal Interior : ME3024	

**GLC X253, C253 2016 -**

Imagen	Clave del Producto y Descripción	Detalles	OEM
	<b>ME20623019</b> Terminales Completas	Peso : 1,630 kg / 3.594 lb Terminal Exterior : ME2062 Terminal Interior : ME3019	
	<b>ME20633019</b> Terminales Completas	Peso : 1,630 kg / 3.594 lb Terminal Exterior : ME2063 Terminal Interior : ME3019	
	<b>ME4103</b> Tornillo Estabilizador	Peso : 1,010 kg / 2.227 lb Tipo de Material : Metal Longitud : 279 mm / 10.98 inch	2533230217, A2533230217
	<b>ME4104</b> Tornillo Estabilizador	Peso : 1,010 kg / 2.227 lb Tipo de Material : Metal Longitud : 279 mm / 10.98 inch	2533230117, A2533230117

**GLE W166 2011 -**

Imagen	Clave del Producto y Descripción	Detalles	OEM
	<b>ME20573024</b> Terminales Completas	Peso : 1,500 kg / 3.307 lb Terminal Exterior : ME2057 Terminal Interior : ME3024	

**GLK CLASS X204 2008 - 2016**

Imagen	Clave del Producto y Descripción	Detalles	OEM
	<b>ME11110</b> Buje De Horquilla & Tijera	Chasis (Delantero / Trasero) : Delantero Posicion : Inferior Trasero Peso : 0,215 kg / 0.474 lb	2123330214
	<b>ME12059</b> Soporte De Transmision	Chasis (Delantero / Trasero) : Delantero Peso : 0,519 kg / 1.144 lb	1402401218, 1402401718 2122400318, 2202400118 2202400418, 5101457AA

**GLS X166 2012 - 2019**

Imagen	Clave del Producto y Descripción	Detalles	OEM
	<b>ME20573024</b> Terminales Completas	Peso : 1,500 kg / 3.307 lb Terminal Exterior : ME2057 Terminal Interior : ME3024	

**M CLASS W163 1998 - 2005**

Imagen	Clave del Producto y Descripción	Detalles	OEM
	<b>ME11037K</b> BUJES	Posicion : Izquierda Y Derecha Peso : 0,26 kg / 0.573 lb	1633300175, A1633300175

**M CLASS W166 2011 -**

Imagen	Clave del Producto y Descripción	Detalles	OEM
	<b>ME20573024</b> Terminales Completas	Peso : 1,500 kg / 3.307 lb Terminal Exterior : ME2057 Terminal Interior : ME3024	

**S CLASS C215 1999 - 2006**

Imagen	Clave del Producto y Descripción	Detalles	OEM
	<b>ME11111</b> Buje De Horquilla & Tijera	Chasis (Delantero / Trasero) : Delantero Posicion : Frontal Superior Peso : 0,200 kg / 0.441 lb	2303330314, Part of 2203301407 Part of 2203308307, Part of 2203309307
	<b>ME12059</b> Soporte De Transmision	Chasis (Delantero / Trasero) : Delantero Peso : 0,519 kg / 1.144 lb	1402401218, 1402401718 2122400318, 2202400118 2202400418, 5101457AA





\* Nombres de los vehiculos, marcas, modelos, simbolos y logos, numero OE y otros numeros de terceros en el sitio web y catalogo solo son con fines de referencia.



**S CLASS W140 1991 - 1999**

Imagen	Clave del Producto y Descripción	Detalles	OEM
	<b>ME12059</b> Soporte De Transmision	Chasis (Delantero / Trasero) : Delantero Peso : 0,519 kg / 1.144 lb	1402401218, 1402401718 2122400318, 2202400118 2202400418, 5101457AA

**S CLASS W220 1999 - 2005**

Imagen	Clave del Producto y Descripción	Detalles	OEM
	<b>ME2074</b> Terminal Exterior	Peso : 1,328 kg / 2.928 lb Longitud : 189 mm / 7.44 inch	2203381415, A2203381415
	<b>ME2075</b> Terminal Exterior	Peso : 1,328 kg / 2.928 lb Longitud : 189 mm / 7.44 inch	2203381315, A2203381315
	<b>ME11111</b> Buje De Horquilla & Tijera	Chasis (Delantero / Trasero) : Delantero Posicion : Frontal Superior Peso : 0,200 kg / 0.441 lb	2303330314, Part of 2203301407 Part of 2203308307, Part of 2203309307
	<b>ME12059</b> Soporte De Transmision	Chasis (Delantero / Trasero) : Delantero Peso : 0,519 kg / 1.144 lb	1402401218, 1402401718 2122400318, 2202400118 2202400418, 5101457AA

**S CLASS W222, V222, X222 4X2 2013 - 2019**

Imagen	Clave del Producto y Descripción	Detalles	OEM
	<b>ME2076</b> Terminal Exterior	Peso : 0,544 kg / 1.199 lb	2223307000, A2223307000

**SL R129 1992 - 2001**

Imagen	Clave del Producto y Descripción	Detalles	OEM
	<b>ME12059</b> Soporte De Transmision	Chasis (Delantero / Trasero) : Delantero Peso : 0,519 kg / 1.144 lb	1402401218, 1402401718 2122400318, 2202400118 2202400418, 5101457AA

**SL R230 2001 - 2012**

Imagen	Clave del Producto y Descripción	Detalles	OEM
	<b>ME12059</b> Soporte De Transmision	Chasis (Delantero / Trasero) : Delantero Peso : 0,519 kg / 1.144 lb	1402401218, 1402401718 2122400318, 2202400118 2202400418, 5101457AA

**SLC R172 2016 -**

Imagen	Clave del Producto y Descripción	Detalles	OEM
	<b>ME9017</b> Horquilla & Tijera	Peso : 0,829 kg / 1.828 lb Tipo de Material : Chapa Metálica	1723500206
	<b>ME9018</b> Horquilla & Tijera	Peso : 0,829 kg / 1.828 lb Tipo de Material : Chapa Metálica	1723500106
	<b>ME9019</b> Horquilla & Tijera	Peso : 0,696 kg / 1.534 lb Tipo de Material : Chapa Metálica	1723500406
	<b>ME11109</b> Buje De Horquilla & Tijera	Chasis (Delantero / Trasero) : Trasera Posicion : Trasero Superior Peso : 0.072 kg / 0.159 lb	1723500106*, 1723500206* 1723520465

**SLK R170 1997 - 2004**

Imagen	Clave del Producto y Descripción	Detalles	OEM
	<b>ME12059</b> Soporte De Transmision	Chasis (Delantero / Trasero) : Delantero Peso : 0,519 kg / 1.144 lb	1402401218, 1402401718 2122400318, 2202400118 2202400418, 5101457AA

**SLK R171 2004 - 2011**

Imagen	Clave del Producto y Descripción	Detalles	OEM
	<b>ME12059</b> Soporte De Transmision	Chasis (Delantero / Trasero) : Delantero Peso : 0,519 kg / 1.144 lb	1402401218, 1402401718 2122400318, 2202400118 2202400418, 5101457AA

**SLK R172 2011 - 2019**

Imagen	Clave del Producto y Descripción	Detalles	OEM
	<b>ME9017</b> Horquilla & Tijera	Peso : 0,829 kg / 1.828 lb Tipo de Material : Chapa Metálica	1723500206
	<b>ME9018</b> Horquilla & Tijera	Peso : 0,829 kg / 1.828 lb Tipo de Material : Chapa Metálica	1723500106
	<b>ME9019</b> Horquilla & Tijera	Peso : 0,696 kg / 1.534 lb Tipo de Material : Chapa Metálica	1723500406
	<b>ME11109</b> Buje De Horquilla & Tijera	Chasis (Delantero / Trasero) : Trasera Posicion : Trasero Superior Peso : 0.072 kg / 0.159 lb	1723500106*, 1723500206* 1723520465
	<b>ME12059</b> Soporte De Transmision	Chasis (Delantero / Trasero) : Delantero Peso : 0,519 kg / 1.144 lb	1402401218, 1402401718 2122400318, 2202400118 2202400418, 5101457AA

**T1 SERIES 1977 - 1996**

Imagen	Clave del Producto y Descripción	Detalles	OEM
	<b>ME12060</b> Goma De Barra Estabilizadora	Chasis (Delantero / Trasero) : Trasera Peso : 0.1 kg / 0.220 lb Tipo de Material : Rubber	2D0511413, 6013210350
	<b>ME12060K</b> Goma De Barra Estabilizadora	Chasis (Delantero / Trasero) : Trasera Peso : 0.2 kg / 0.441 lb Tipo de Material : Rubber Nota : 2 Pieces	2D0511413, 6013210350

**V CLASS 638-2 1996 - 2003**

Imagen	Clave del Producto y Descripción	Detalles	OEM
	<b>ME11048K</b> Buje De Horquilla & Tijera	Posicion : Izquierda Y Derecha Peso : 0,001 kg / 0.002 lb Nota : 2 Pieces	6383330014

**V CLASS W639 2003 - 2014**

Imagen	Clave del Producto y Descripción	Detalles	OEM
	<b>ME11048K</b> Buje De Horquilla & Tijera	Posicion : Izquierda Y Derecha Peso : 0,001 kg / 0.002 lb Nota : 2 Pieces	6383330014

**VIANO W639 2003 - 2014**

Imagen	Clave del Producto y Descripción	Detalles	OEM
	<b>ME4105</b> Tornillo Estabilizador	Peso : 0,470 kg / 1.036 lb Tipo de Material : Metal Longitud : 297 mm / 11.69 inch Diametro de Cuerda del Perno : M12X1,5 Nota : 4 MATIC / ONLY:2011-2014	6393200889, A6393200889
	<b>ME4106</b> Tornillo Estabilizador	Peso : 0,470 kg / 1.036 lb Tipo de Material : Metal Longitud : 297 mm / 11.69 inch Diametro de Cuerda del Perno : M12X1,5 Nota : 4 MATIC / ONLY:2011-2014	6393200789, A6393200789
	<b>ME11048K</b> Buje De Horquilla & Tijera	Posicion : Izquierda Y Derecha Peso : 0,001 kg / 0.002 lb Nota : 2 Pieces	6383330014

**VITO W638 1997 - 2003**





Imagen	Clave del Producto y Descripción	Detalles	OEM
	<b>ME11048K</b> Buje De Horquilla & Tijera	Posicion : Izquierda Y Derecha Peso : 0,001 kg / 0.002 lb Nota : 2 Pieces	6383330014

**VITO W639 2003 - 2014**

Imagen	Clave del Producto y Descripción	Detalles	OEM
	<b>ME4105</b> Tornillo Estabilizador	Peso : 0,470 kg / 1.036 lb Tipo de Material : Metal Longitud : 297 mm / 11.69 inch Diametro de Cuerda del Perno : M12X1,5 Nota : 4 MATIC / ONLY:2011-2014	6393200889, A6393200889
	<b>ME4106</b> Tornillo Estabilizador	Peso : 0,470 kg / 1.036 lb Tipo de Material : Metal Longitud : 297 mm / 11.69 inch Diametro de Cuerda del Perno : M12X1,5 Nota : 4 MATIC / ONLY:2011-2014	6393200789, A6393200789
	<b>ME11048K</b> Buje De Horquilla & Tijera	Posicion : Izquierda Y Derecha Peso : 0,001 kg / 0.002 lb Nota : 2 Pieces	6383330014

\* Nombres de los vehículos, marcas, modelos, símbolos y logos, número OE y otros números de terceros en el sitio web y catálogo solo son con fines de referencia.

**X CLASS**
**W470**
**2017 - 2020**

Imagen	Clave del Producto y Descripción	Detalles	OEM
	<b>ME1029</b> Rotula	Peso : 0,668 kg / 1.473 lb Diámetro del Cuerpo de la Rotu : Ø43,3	4703300700*, 4703301000* 54500-5XA0A*, 54501-5XA0A* A4703300700*, A4703301000*
	<b>ME4107</b> Tornillo Estabilizador	Peso : 0,383 kg / 0.844 lb Tipo de Material : Metal Longitud : 70 mm / 2.76 inch	4703202300, 54618-4KH0A 54618-5XA0A, A4703202300
	<b>ME4108</b> Tornillo Estabilizador	Peso : 0,383 kg / 0.844 lb Tipo de Material : Metal Longitud : 70 mm / 2.76 inch	4703202200, 54668-4KH0A 54668-5XA0A, A4703202200
	<b>ME4109</b> Tornillo Estabilizador	Peso : 0,508 kg / 1.120 lb Tipo de Material : Metal Longitud : 210 mm / 8.27 inch Nota : Metal	4703260100, 562614KH0A 562615XA0A

**RIW®**

**MERCURY**

**CAPRI II 1979 - 1986**

Imagen	Clave del Producto y Descripción	Detalles	OEM
	<b>FO4080</b> Tornillo Estabilizador	Peso : 0,322 kg / 0.710 lb Longitud : 233,5 mm / 9.19 inch	D8BZ5A486A, E6LY5A486A E6ZZ5A486A, F1ZZ5A486A

**COLONY PARK III 1957 - 1958**

Imagen	Clave del Producto y Descripción	Detalles	OEM
	<b>CD4005</b> Tornillo Estabilizador	Peso : 0,220 kg / 0.485 lb Longitud : 145 mm / 5.71 inch	25679063, 3879218

**COLONY PARK III 1959 - 1960**

Imagen	Clave del Producto y Descripción	Detalles	OEM
	<b>CD4005</b> Tornillo Estabilizador	Peso : 0,220 kg / 0.485 lb Longitud : 145 mm / 5.71 inch	25679063, 3879218

**COLONY PARK III 1961 - 1964**

Imagen	Clave del Producto y Descripción	Detalles	OEM
	<b>CD4005</b> Tornillo Estabilizador	Peso : 0,220 kg / 0.485 lb Longitud : 145 mm / 5.71 inch	25679063, 3879218

**COLONY PARK VI 1965 - 1966**

Imagen	Clave del Producto y Descripción	Detalles	OEM
	<b>CV4056</b> Tornillo Estabilizador	Peso : 0,182 kg / 0.401 lb Longitud : 195,5 mm / 7.70 inch	25784241

**COLONY PARK VI 1967 - 1968**

Imagen	Clave del Producto y Descripción	Detalles	OEM
	<b>CV4056</b> Tornillo Estabilizador	Peso : 0,182 kg / 0.401 lb Longitud : 195,5 mm / 7.70 inch	25784241

\* Nombres de los vehículos, marcas, modelos, símbolos y logos, número OE y otros números de terceros en el sitio web y catálogo solo son con fines de referencia.

**COLONY PARK VI 1969 - 1970**

Imagen	Clave del Producto y Descripción	Detalles	OEM
	<b>CV4056</b> Tornillo Estabilizador	Peso : 0,182 kg / 0.401 lb Longitud : 195,5 mm / 7.70 inch	25784241

**COLONY PARK VI 1971 - 1978**

Imagen	Clave del Producto y Descripción	Detalles	OEM
	<b>CV4056</b> Tornillo Estabilizador	Peso : 0,182 kg / 0.401 lb Longitud : 195,5 mm / 7.70 inch	25784241

**COLONY PARK VI 1979 - 1991**

Imagen	Clave del Producto y Descripción	Detalles	OEM
	<b>FO2077</b> TERMINAL EXTERIOR FRONTAL EXTERIOR	Peso : 0,450 kg / 0.992 lb Longitud : 71,1 mm / 2.80 inch	2W7Z3A130A, 2W7Z3A130AA D9AZ3A130A, F3AZ3A130A F5AZ3A130A
	<b>CV4056</b> Tornillo Estabilizador	Peso : 0,182 kg / 0.401 lb Longitud : 195,5 mm / 7.70 inch	25784241

**COMET 1960 - 1977**

Imagen	Clave del Producto y Descripción	Detalles	OEM
	<b>CD4005</b> Tornillo Estabilizador	Peso : 0,220 kg / 0.485 lb Longitud : 145 mm / 5.71 inch	25679063, 3879218

**COUGAR IV 1974 - 1976**

Imagen	Clave del Producto y Descripción	Detalles	OEM
	<b>CV4056</b> Tornillo Estabilizador	Peso : 0,182 kg / 0.401 lb Longitud : 195,5 mm / 7.70 inch	25784241



**COUGAR V 1977 - 1979**

Imagen	Clave del Producto y Descripción	Detalles	OEM
	<b>CV4056</b> Tornillo Estabilizador	Peso : 0,182 kg / 0.401 lb Longitud : 195,5 mm / 7.70 inch	25784241

**COUGAR VIII 1989 - 1997**

Imagen	Clave del Producto y Descripción	Detalles	OEM
	<b>FO3052</b> Terminal interior	Peso : 0,583 kg / 1.285 lb Longitud : 338 mm / 13.31 inch	E6DZ3280A, F6SZ3280BA

**GRAND MARQUIS I 1983 - 1991**

Imagen	Clave del Producto y Descripción	Detalles	OEM
	<b>FO2077</b> TERMINAL EXTERIOR FRONTAL EXTERIOR	Peso : 0,450 kg / 0.992 lb Longitud : 71,1 mm / 2.80 inch	2W7Z3A130A, 2W7Z3A130AA D9AZ3A130A, F3AZ3A130A F5AZ3A130A
	<b>FO2089</b> Terminal Exterior	Peso : 0,561 kg / 1.237 lb Longitud : 165 mm / 6.50 inch	2W7Z3A131A, 2W7Z3A131AA D9AZ3A131A, F5AZ3A131A

**GRAND MARQUIS II 1992 - 1997**

Imagen	Clave del Producto y Descripción	Detalles	OEM
	<b>FO2077</b> TERMINAL EXTERIOR FRONTAL EXTERIOR	Peso : 0,450 kg / 0.992 lb Longitud : 71,1 mm / 2.80 inch	2W7Z3A130A, 2W7Z3A130AA D9AZ3A130A, F3AZ3A130A F5AZ3A130A
	<b>FO2089</b> Terminal Exterior	Peso : 0,561 kg / 1.237 lb Longitud : 165 mm / 6.50 inch	2W7Z3A131A, 2W7Z3A131AA D9AZ3A131A, F5AZ3A131A

**GRAND MARQUIS III 1998 - 2002**

Imagen	Clave del Producto y Descripción	Detalles	OEM
	<b>FO2077</b> TERMINAL EXTERIOR FRONTAL EXTERIOR	Peso : 0,450 kg / 0.992 lb Longitud : 71,1 mm / 2.80 inch	2W7Z3A130A, 2W7Z3A130AA D9AZ3A130A, F3AZ3A130A F5AZ3A130A

\* Nombres de los vehículos, marcas, modelos, símbolos y logos, número OE y otros números de terceros en el sitio web y catálogo solo son con fines de referencia.

**GRAND MARQUIS**
**III**
**1998 - 2002**

Imagen	Clave del Producto y Descripción	Detalles	OEM
	<b>FO2089</b> Terminal Exterior	Peso : 0,561 kg / 1.237 lb Longitud : 165 mm / 6.50 inch	2W7Z3A131A, 2W7Z3A131AA D9AZ3A131A, F5AZ3A131A
	<b>FO4077</b> Tornillo Estabilizador	Peso : 0,401 kg / 0.884 lb Tipo de Material : Metal Longitud : 160 mm / 6.30 inch	F5AZ5K484A, F5AZ6K484AA F8AZ5K484AA

**METEOR**
**1961 - 1963**

Imagen	Clave del Producto y Descripción	Detalles	OEM
	<b>CD4005</b> Tornillo Estabilizador	Peso : 0,220 kg / 0.485 lb Longitud : 145 mm / 5.71 inch	25679063, 3879218

**MILAN**
**2006 - 2012**

Imagen	Clave del Producto y Descripción	Detalles	OEM
	<b>FO3054</b> Terminal interior	Peso : 0,407 kg / 0.897 lb Longitud : 179 mm / 7.05 inch Tamaño de la Rosca : M14X1,5 Diámetro de Cuerda del Perno : M14X1,5	AE5Z3280A

**MONARCH**
**1975 - 1980**

Imagen	Clave del Producto y Descripción	Detalles	OEM
	<b>CD4005</b> Tornillo Estabilizador	Peso : 0,220 kg / 0.485 lb Longitud : 145 mm / 5.71 inch	25679063, 3879218

**MONTCLAIR**
**IV**
**1965 - 1966**

Imagen	Clave del Producto y Descripción	Detalles	OEM
	<b>CV4056</b> Tornillo Estabilizador	Peso : 0,182 kg / 0.401 lb Longitud : 195,5 mm / 7.70 inch	25784241

**MONTCLAIR V 1967 - 1968**

Imagen	Clave del Producto y Descripción	Detalles	OEM
	<b>CV4056</b> Tornillo Estabilizador	Peso : 0,182 kg / 0.401 lb Longitud : 195,5 mm / 7.70 inch	25784241

**MONTEGO II 1972 - 1976**

Imagen	Clave del Producto y Descripción	Detalles	OEM
	<b>CV4056</b> Tornillo Estabilizador	Peso : 0,182 kg / 0.401 lb Longitud : 195,5 mm / 7.70 inch	25784241

**MONTEGO III 2005 - 2007**

Imagen	Clave del Producto y Descripción	Detalles	OEM
	<b>FO4075</b> Tornillo Estabilizador	Peso : 0,324 kg / 0.714 lb Tipo de Material : Metal Longitud : 141 mm / 5.55 inch	5F9Z5K484AS, 7F9Z5K484S

**MONTEREY IX 1971 - 1974**

Imagen	Clave del Producto y Descripción	Detalles	OEM
	<b>CV4056</b> Tornillo Estabilizador	Peso : 0,182 kg / 0.401 lb Longitud : 195,5 mm / 7.70 inch	25784241

**MONTEREY V 1961 - 1964**

Imagen	Clave del Producto y Descripción	Detalles	OEM
	<b>CD4005</b> Tornillo Estabilizador	Peso : 0,220 kg / 0.485 lb Longitud : 145 mm / 5.71 inch	25679063, 3879218

**MONTEREY VI 1965 - 1966**

Imagen	Clave del Producto y Descripción	Detalles	OEM
	<b>CV4056</b> Tornillo Estabilizador	Peso : 0,182 kg / 0.401 lb Longitud : 195,5 mm / 7.70 inch	25784241

\* Nombres de los vehículos, marcas, modelos, símbolos y logos, número OE y otros números de terceros en el sitio web y catálogo solo son con fines de referencia.

**MONTEREY VII 1967 - 1968**

Imagen	Clave del Producto y Descripción	Detalles	OEM
	<b>CV4056</b> Tornillo Estabilizador	Peso : 0,182 kg / 0.401 lb Longitud : 195,5 mm / 7.70 inch	25784241





**MONTEREY VIII 1969 - 1970**

Imagen	Clave del Producto y Descripción	Detalles	OEM
	<b>CV4056</b> Tornillo Estabilizador	Peso : 0,182 kg / 0.401 lb Longitud : 195,5 mm / 7.70 inch	25784241

**MOUNTAINEER 1997 - 2001**

Imagen	Clave del Producto y Descripción	Detalles	OEM
	<b>FO2093</b> Terminal Exterior	Peso : 0,556 kg / 1.226 lb Longitud : 112 mm / 4.41 inch	5L5Z3A130AA, F87Z3A130BA ZZP032365, ZZP032365A
	<b>FO4082</b> Tornillo Estabilizador	Peso : 0,671 kg / 1.479 lb Tipo de Material : Metal Longitud : 241 mm / 9.49 inch	F57Z5K484A, YL2Z5K484AA

**MOUNTAINEER 2002 - 2005**

Imagen	Clave del Producto y Descripción	Detalles	OEM
	<b>FO2093</b> Terminal Exterior	Peso : 0,556 kg / 1.226 lb Longitud : 112 mm / 4.41 inch	5L5Z3A130AA, F87Z3A130BA ZZP032365, ZZP032365A
	<b>LC2001</b> Terminal Exterior	Peso : 1,369 kg / 3.018 lb Longitud : 585 mm / 23.03 inch	1L2Z5A972AB, 2L2Z5A972AA
	<b>LC2002</b> Terminal Exterior		1L2Z5A972AB, 2L2Z5A972AA
	<b>LC20012002</b> Terminales Completas	Peso : 1,743 kg / 3.843 lb Terminal Exterior : LC2001 Terminal Interior : LC2002	1L2Z5A972AB*, 2L2Z5A972AA*

\* Nombres de los vehículos, marcas, modelos, símbolos y logos, número OE y otros números de terceros en el sitio web y catálogo solo son con fines de referencia.

**MOUNTAINEER**
**2002 - 2005**

Imagen	Clave del Producto y Descripción	Detalles	OEM
	<b>FO4081</b> Tornillo Estabilizador	Peso : 0,336 kg / 0.741 lb Longitud : 163 mm / 6.42 inch	6L2Z5K484BA

**PARK LANE**
**II**
**1964 - 1966**

Imagen	Clave del Producto y Descripción	Detalles	OEM
	<b>CV4056</b> Tornillo Estabilizador	Peso : 0,182 kg / 0.401 lb Longitud : 195,5 mm / 7.70 inch	25784241

**SABLE**
**1986 - 1991**

Imagen	Clave del Producto y Descripción	Detalles	OEM
	<b>FO3052</b> Terminal interior	Peso : 0,583 kg / 1.285 lb Longitud : 338 mm / 13.31 inch	E6DZ3280A, F6SZ3280BA
	<b>FO4076</b> Tornillo Estabilizador	Peso : 0,478 kg / 1.054 lb Tipo de Material : Metal Longitud : 265 mm / 10.43 inch Diámetro de Cuerda del Perno : M12X1,75	E6DZ5K484A, F4DZ5K484A F78Z5K483AA
	<b>FO4079</b> Tornillo Estabilizador	Peso : 0,276 kg / 0.608 lb Longitud : 288 mm / 11.34 inch	E6DZ5A486A, E9DZ5A486A

**SABLE**
**1992 - 1995**

Imagen	Clave del Producto y Descripción	Detalles	OEM
	<b>FO3052</b> Terminal interior	Peso : 0,583 kg / 1.285 lb Longitud : 338 mm / 13.31 inch	E6DZ3280A, F6SZ3280BA
	<b>FO4076</b> Tornillo Estabilizador	Peso : 0,478 kg / 1.054 lb Tipo de Material : Metal Longitud : 265 mm / 10.43 inch Diámetro de Cuerda del Perno : M12X1,75	E6DZ5K484A, F4DZ5K484A F78Z5K483AA
	<b>FO4079</b> Tornillo Estabilizador	Peso : 0,276 kg / 0.608 lb Longitud : 288 mm / 11.34 inch	E6DZ5A486A, E9DZ5A486A

\* Nombres de los vehículos, marcas, modelos, símbolos y logos, número OE y otros números de terceros en el sitio web y catálogo solo son con fines de referencia.

**SABLE**
**1996 - 1999**

Imagen	Clave del Producto y Descripción	Detalles	OEM
	<b>FO1053</b> Rotula	Peso : 0,354 kg / 0.780 lb	5F1Z3050A, 5F1Z3V050A F5OY3K185A, F5OY3K186A F6DZ3K185A, F6DZ3K186A XF1Z3050AA
	<b>FO2080</b> TERMINAL EXTERIOR FRONTAL EXTERIOR	Peso : 0,505 kg / 1.113 lb Longitud : 102 mm / 4.02 inch	3F1Z3A130AA, F6DZ3A130A
	<b>FO3053</b> Terminal interior	Peso : 0,621 kg / 1.369 lb Longitud : 341,6 mm / 13.45 inch	1F1Z3280AA, F6DZ3280AA
	<b>FO4073</b> Tornillo Estabilizador	Peso : 0,494 kg / 1.089 lb Tipo de Material : Metal Longitud : 272 mm / 10.71 inch	1F1Z5K484AA, 1F1Z5K484BA 2F1Z5K484BA, 3F1Z5K484A 3F1Z5K484AA, F5Y05K484A F5Y05K484A
	<b>FO4074</b> Tornillo Estabilizador	Peso : 0,494 kg / 1.089 lb Tipo de Material : Metal Longitud : 272 mm / 10.71 inch	1F1Z5K483AA, 1F1Z5K483BA 3F1Z5K483A, 3F1Z5K483AA F5Y05K483A, F70Z5K483AA F70Z5K483AA
	<b>FO4079</b> Tornillo Estabilizador	Peso : 0,276 kg / 0.608 lb Longitud : 288 mm / 11.34 inch	E6DZ5A486A, E9DZ5A486A

**SABLE**
**1999 - 2005**

Imagen	Clave del Producto y Descripción	Detalles	OEM
	<b>FO1053</b> Rotula	Peso : 0,354 kg / 0.780 lb	5F1Z3050A, 5F1Z3V050A F5OY3K185A, F5OY3K186A F6DZ3K185A, F6DZ3K186A XF1Z3050AA
	<b>FO2080</b> TERMINAL EXTERIOR FRONTAL EXTERIOR	Peso : 0,505 kg / 1.113 lb Longitud : 102 mm / 4.02 inch	3F1Z3A130AA, F6DZ3A130A
	<b>FO3053</b> Terminal interior	Peso : 0,621 kg / 1.369 lb Longitud : 341,6 mm / 13.45 inch	1F1Z3280AA, F6DZ3280AA
	<b>FO4073</b> Tornillo Estabilizador	Peso : 0,494 kg / 1.089 lb Tipo de Material : Metal Longitud : 272 mm / 10.71 inch	1F1Z5K484AA, 1F1Z5K484BA 2F1Z5K484BA, 3F1Z5K484A 3F1Z5K484AA, F5Y05K484A F5Y05K484A

\* Nombres de los vehículos, marcas, modelos, símbolos y logos, número OE y otros números de terceros en el sitio web y catálogo solo son con fines de referencia.

**SABLE**
**1999 - 2005**

Imagen	Clave del Producto y Descripción	Detalles	OEM
	<b>FO4074</b> Tornillo Estabilizador	Peso : 0,494 kg / 1.089 lb Tipo de Material : Metal Longitud : 272 mm / 10.71 inch	1F1Z5K483AA, 1F1Z5K483BA 3F1Z5K483A, 3F1Z5K483AA F5Y05K483A, F70Z5K483AA F70Z5K483AA
	<b>FO4079</b> Tornillo Estabilizador	Peso : 0,276 kg / 0.608 lb Longitud : 288 mm / 11.34 inch	E6DZ5A486A, E9DZ5A486A
	<b>FO6136</b> Horquilla & Tijera	Peso : 3,460 kg / 7.628 lb Tipo de Material : Chapa Metálica	3F1Z3078AA, F8DZ3078AB
	<b>FO6137</b> Horquilla & Tijera	Peso : 3,460 kg / 7.628 lb Tipo de Material : Chapa Metálica	3F1Z3079AA, F8DZ3079AB

**SABLE**
**2008 - 2009**

Imagen	Clave del Producto y Descripción	Detalles	OEM
	<b>FO4075</b> Tornillo Estabilizador	Peso : 0,324 kg / 0.714 lb Tipo de Material : Metal Longitud : 141 mm / 5.55 inch	5F9Z5K484AS, 7F9Z5K484S

**VILLAGER**
**1961 - 1964**

Imagen	Clave del Producto y Descripción	Detalles	OEM
	<b>CD4005</b> Tornillo Estabilizador	Peso : 0,220 kg / 0.485 lb Longitud : 145 mm / 5.71 inch	25679063, 3879218

**ZEPHYR**
**1978 - 1983**

Imagen	Clave del Producto y Descripción	Detalles	OEM
	<b>FO4080</b> Tornillo Estabilizador	Peso : 0,322 kg / 0.710 lb Longitud : 233,5 mm / 9.19 inch	D8BZ5A486A, E6LY5A486A E6ZZ5A486A, F1ZZ5A486A

**RIW®**

**MINI**



**COOPER CLUBMAN R55, R56 2006 - 2010**

Imagen	Clave del Producto y Descripción	Detalles	OEM
	<b>MC9001</b> Horquilla & Tijera	Peso : 1,042 kg / 2.297 lb Tipo de Material : Chapa Metálica	1490085, 33321490085 33326768724, 33326768726 33326769020, 6768724 6768726, 6769020

**COOPER CONVERTIBLE R57 2008 - 2015**

Imagen	Clave del Producto y Descripción	Detalles	OEM
	<b>MC9001</b> Horquilla & Tijera	Peso : 1,042 kg / 2.297 lb Tipo de Material : Chapa Metálica	1490085, 33321490085 33326768724, 33326768726 33326769020, 6768724 6768726, 6769020

**COOPER COUPE R58 2011 - 2015**

Imagen	Clave del Producto y Descripción	Detalles	OEM
	<b>MC9001</b> Horquilla & Tijera	Peso : 1,042 kg / 2.297 lb Tipo de Material : Chapa Metálica	1490085, 33321490085 33326768724, 33326768726 33326769020, 6768724 6768726, 6769020

**COOPER PACEMAN R61 2012 - 2016**

Imagen	Clave del Producto y Descripción	Detalles	OEM
	<b>MC6007K</b> HORQUILLAS FRONTAL DERECHO INFERIOR	Peso : 6,318 kg / 13.929 lb Tipo de Material : Acero Forjado	31129804431, 31129806519
	<b>MC6008K</b> HORQUILLAS FRONTAL INFERIOR IZQUIERDO	Peso : 6,318 kg / 13.929 lb Tipo de Material : Acero Forjado	31129804432, 31129806520
	<b>MC9001</b> Horquilla & Tijera	Peso : 1,042 kg / 2.297 lb Tipo de Material : Chapa Metálica	1490085, 33321490085 33326768724, 33326768726 33326769020, 6768724 6768726, 6769020

**COOPER ROADSTER R59 2011 - 2015**

Imagen	Clave del Producto y Descripción	Detalles	OEM
	<b>MC9001</b> Horquilla & Tijera	Peso : 1,042 kg / 2.297 lb Tipo de Material : Chapa Metálica	1490085, 33321490085 33326768724, 33326768726 33326769020, 6768724 6768726, 6769020

\* Nombres de los vehículos, marcas, modelos, símbolos y logos, número OE y otros números de terceros en el sitio web y catálogo solo son con fines de referencia.

**COOPER S R50, R53 2001 - 2006**

Imagen	Clave del Producto y Descripción	Detalles	OEM
	<b>MC9001</b> Horquilla & Tijera	Peso : 1,042 kg / 2.297 lb Tipo de Material : Chapa Metálica	1490085, 33321490085 33326768724, 33326768726 33326769020, 6768724 6768726, 6769020

**COOPER S ONE R52 2004 - 2007**

Imagen	Clave del Producto y Descripción	Detalles	OEM
	<b>MC9001</b> Horquilla & Tijera	Peso : 1,042 kg / 2.297 lb Tipo de Material : Chapa Metálica	1490085, 33321490085 33326768724, 33326768726 33326769020, 6768724 6768726, 6769020

**COUNTRYMAN R60 2010 - 2016**

Imagen	Clave del Producto y Descripción	Detalles	OEM
	<b>MC6007K</b> HORQUILLAS FRONTAL DERECHO INFERIOR	Peso : 6,318 kg / 13.929 lb Tipo de Material : Acero Forjado	31129804431, 31129806519
	<b>MC6008K</b> HORQUILLAS FRONTAL INFERIOR IZQUIERDO	Peso : 6,318 kg / 13.929 lb Tipo de Material : Acero Forjado	31129804432, 31129806520
	<b>MC9001</b> Horquilla & Tijera	Peso : 1,042 kg / 2.297 lb Tipo de Material : Chapa Metálica	1490085, 33321490085 33326768724, 33326768726 33326769020, 6768724 6768726, 6769020

**RIW®**

**MITSUBISHI**

**AIRTREK**
**2003 - 2006**

Imagen	Clave del Producto y Descripción	Detalles	OEM
	<b>MI4040</b> Tornillo Estabilizador	Peso : 0,246 kg / 0.542 lb Longitud : 93 mm / 3.66 inch Diámetro de Cuerda del Perno : M10X1,25 Nota : 4WD	4056A040, MR319147

**ASX**
**GA, W FACELIFT**
**2013 - 2016**

Imagen	Clave del Producto y Descripción	Detalles	OEM
	<b>MI1023</b> Rotula	Peso : 0,326 kg / 0.719 lb	1612753380*, 4013A443* 4013A444*

**CARISMA**
**1995 - 2000**

Imagen	Clave del Producto y Descripción	Detalles	OEM
	<b>MI11019</b> Buje De Horquilla & Tijera	Chasis (Delantero / Trasero) : Trasera Posicion : Inferior Chico Peso : 0.15 kg / 0.331 lb Nota : Pequeña	Part of MB809222, Part of MB809223 Part of MB910841, Part of MB910842
	<b>MI11020</b> Buje De Horquilla & Tijera	Chasis (Delantero / Trasero) : Trasera Posicion : Inferior Grande Peso : 0.22 kg / 0.485 lb Nota : Grande	Part of MB809222, Part of MB809223 Part of MB910841, Part of MB910842 Part of MR491347, Part of MR491348

**CARISMA**
**2000 - 2006**

Imagen	Clave del Producto y Descripción	Detalles	OEM
	<b>MI11019</b> Buje De Horquilla & Tijera	Chasis (Delantero / Trasero) : Trasera Posicion : Inferior Chico Peso : 0.15 kg / 0.331 lb Nota : Pequeña	Part of MB809222, Part of MB809223 Part of MB910841, Part of MB910842
	<b>MI11020</b> Buje De Horquilla & Tijera	Chasis (Delantero / Trasero) : Trasera Posicion : Inferior Grande Peso : 0.22 kg / 0.485 lb Nota : Grande	Part of MB809222, Part of MB809223 Part of MB910841, Part of MB910842 Part of MR491347, Part of MR491348

**COLT**
**V**
**1995 - 2004**

Imagen	Clave del Producto y Descripción	Detalles	OEM
	<b>MI1025</b> Rotula	Peso : 0,360 kg / 0.794 lb	MR241341*, MR241342*

\* Nombres de los vehículos, marcas, modelos, símbolos y logos, número OE y otros números de terceros en el sitio web y catálogo solo son con fines de referencia.

**COLT V 1995 - 2004**

Imagen	Clave del Producto y Descripción	Detalles	OEM
	<b>MI11019</b> Buje De Horquilla & Tijera	Chasis (Delantero / Trasero) : Trasera Posicion : Inferior Chico Peso : 0.15 kg / 0.331 lb Nota : Pequeña	Part of MB809222, Part of MB809223 Part of MB910841, Part of MB910842
	<b>MI11020</b> Buje De Horquilla & Tijera	Chasis (Delantero / Trasero) : Trasera Posicion : Inferior Grande Peso : 0.22 kg / 0.485 lb Nota : Grande	Part of MR491347, Part of MR491348 Part of MB809222, Part of MB809223 Part of MB910841, Part of MB910842 Part of MR491347, Part of MR491348

**DELICA 1994 - 2006**

Imagen	Clave del Producto y Descripción	Detalles	OEM
	<b>MI1027</b> Rotula	Peso : 1,184 kg / 2.610 lb	MR208664
	<b>MI1028</b> Rotula	Peso : 1,184 kg / 2.610 lb	MR208663

**ECLIPSE D50 2000 - 2005**

Imagen	Clave del Producto y Descripción	Detalles	OEM
	<b>MI3025</b> Terminal interior	Peso : 0,624 kg / 1.376 lb Longitud : 316 mm / 12.44 inch Tamaño de la Rosca : M14X1,5 Diámetro de Cuerda del Perno : M14X1,5	MR519046

**EXPO 1991 - 1997**

Imagen	Clave del Producto y Descripción	Detalles	OEM
	<b>MI4037</b> Tornillo Estabilizador	Peso : 0,210 kg / 0.463 lb Longitud : 140 mm / 5.51 inch Nota : FOR SPORT MODEL	4056A138, MR344624 MR555883, MR586053

**GALANT EA0 1996 - 2004**

Imagen	Clave del Producto y Descripción	Detalles	OEM
	<b>MI3025</b> Terminal interior	Peso : 0,624 kg / 1.376 lb Longitud : 316 mm / 12.44 inch Tamaño de la Rosca : M14X1,5 Diámetro de Cuerda del Perno : M14X1,5	MR519046

\* Nombres de los vehículos, marcas, modelos, símbolos y logos, número OE y otros números de terceros en el sitio web y catálogo solo son con fines de referencia.

**L400**
**1995 - 2005**

Imagen	Clave del Producto y Descripción	Detalles	OEM
	<b>MI1027</b> Rotula	Peso : 1,184 kg / 2.610 lb	MR208664
	<b>MI1028</b> Rotula	Peso : 1,184 kg / 2.610 lb	MR208663

**LANCER**
**VII CSW, CSA**
**2003 - 2008**

Imagen	Clave del Producto y Descripción	Detalles	OEM
	<b>MI9013</b> Horquilla & Tijera	Peso : 1,408 kg / 3.104 lb Tipo de Material : Chapa Metálica	MR491911

**LANCER**
**VIII CY0 FACELIFT**
**2016 -**

Imagen	Clave del Producto y Descripción	Detalles	OEM
	<b>MI1023</b> Rotula	Peso : 0,326 kg / 0.719 lb	1612753380*, 4013A443* 4013A444*

**MIRAGE**
**1995 - 2003**

Imagen	Clave del Producto y Descripción	Detalles	OEM
	<b>MI1025</b> Rotula	Peso : 0,360 kg / 0.794 lb	MR241341*, MR241342*
	<b>MI11019</b> Buje De Horquilla & Tijera	Chasis (Delantero / Trasero) : Trasera Posicion : Inferior Chico Peso : 0.15 kg / 0.331 lb Nota : Pequeña	Part of MB809222, Part of MB809223 Part of MB910841, Part of MB910842
	<b>MI11020</b> Buje De Horquilla & Tijera	Chasis (Delantero / Trasero) : Trasera Posicion : Inferior Grande Peso : 0.22 kg / 0.485 lb Nota : Grande	Part of MR491347, Part of MR491348 Part of MB809222, Part of MB809223 Part of MB910841, Part of MB910842 Part of MR491347, Part of MR491348

**MIRAGE**
**2012 -**

Imagen	Clave del Producto y Descripción	Detalles	OEM
	<b>MI1026</b> Rotula	Peso : 0,252 kg / 0.556 lb	4013A309*, 4013A310*
	<b>MI3024</b> Terminal interior	Peso : 0,568 kg / 1.252 lb Longitud : 344 mm / 13.54 inch	4422A098
	<b>MI6048</b> Horquilla & Tijera	Peso : 2,507 kg / 5.527 lb Tipo de Material : Chapa Metálica	4013A310
	<b>MI6049</b> Horquilla & Tijera	Peso : 2,507 kg / 5.527 lb Tipo de Material : Chapa Metálica	4013A309

**MONTERO**
**I**
**1982 - 1990**

Imagen	Clave del Producto y Descripción	Detalles	OEM
	<b>CD4005</b> Tornillo Estabilizador	Peso : 0,220 kg / 0.485 lb Longitud : 145 mm / 5.71 inch	25679063, 3879218

**MONTERO**
**II**
**1990 - 2000**

Imagen	Clave del Producto y Descripción	Detalles	OEM
	<b>CD4005</b> Tornillo Estabilizador	Peso : 0,220 kg / 0.485 lb Longitud : 145 mm / 5.71 inch	25679063, 3879218

**MONTERO**
**III**
**2001 - 2007**

Imagen	Clave del Producto y Descripción	Detalles	OEM
	<b>MI1029</b> Rotula	Peso : 1,266 kg / 2.791 lb	4110A073, MR508130
	<b>MI4037</b> Tornillo Estabilizador	Peso : 0,210 kg / 0.463 lb Longitud : 140 mm / 5.51 inch Nota : FOR SPORT MODEL	4056A138, MR344624 MR555883, MR586053

\* Nombres de los vehículos, marcas, modelos, símbolos y logos, número OE y otros números de terceros en el sitio web y catálogo solo son con fines de referencia.

**NIMBUS 1991 - 1997**

Imagen	Clave del Producto y Descripción	Detalles	OEM
	<b>MI4037</b> Tornillo Estabilizador	Peso : 0,210 kg / 0.463 lb Longitud : 140 mm / 5.51 inch Nota : FOR SPORT MODEL	4056A138, MR344624 MR555883, MR586053

**NIMBUS 1997 - 2003**

Imagen	Clave del Producto y Descripción	Detalles	OEM
	<b>MI4037</b> Tornillo Estabilizador	Peso : 0,210 kg / 0.463 lb Longitud : 140 mm / 5.51 inch Nota : FOR SPORT MODEL	4056A138, MR344624 MR555883, MR586053
	<b>MI4038</b> Tornillo Estabilizador	Peso : 0,398 kg / 0.877 lb Tipo de Material : Metal Longitud : 240 mm / 9.45 inch	4056A035, MR316436
	<b>MI4039</b> Tornillo Estabilizador	Peso : 0,398 kg / 0.877 lb Tipo de Material : Metal Longitud : 240 mm / 9.45 inch	4056A034, MR316435

**OUTLANDER I 2.0 - 2.4 4WD 2003 - 2006**

Imagen	Clave del Producto y Descripción	Detalles	OEM
	<b>MI1023</b> Rotula	Peso : 0,326 kg / 0.719 lb	1612753380*, 4013A443* 4013A444*
	<b>MI4040</b> Tornillo Estabilizador	Peso : 0,246 kg / 0.542 lb Longitud : 93 mm / 3.66 inch Diametro de Cuerda del Perno : M10X1,25 Nota : 4WD	4056A040, MR319147

**OUTLANDER III CW0 1ST FACELIFT 2015 - 2019**

Imagen	Clave del Producto y Descripción	Detalles	OEM
	<b>MI1023</b> Rotula	Peso : 0,326 kg / 0.719 lb	1612753380*, 4013A443* 4013A444*







**PAJERO III 2000 - 2007**

Imagen	Clave del Producto y Descripción	Detalles	OEM
	<b>MI4037</b> Tornillo Estabilizador	Peso : 0,210 kg / 0.463 lb Longitud : 140 mm / 5.51 inch Nota : FOR SPORT MODEL	4056A138, MR344624 MR555883, MR586053

**PAJERO IV 2007 -**

Imagen	Clave del Producto y Descripción	Detalles	OEM
	<b>MI1029</b> Rotula	Peso : 1,266 kg / 2.791 lb	4110A073, MR508130

**RAIDER I 2006 - 2009**

Imagen	Clave del Producto y Descripción	Detalles	OEM
	<b>DO1012</b> Rotula	Peso : 0,663 kg / 1.462 lb	05161685AB, 5161685AA 5161685AB
	<b>DO4016</b> Tornillo Estabilizador	Peso : 0,534 kg / 1.177 lb Longitud : 123,1 mm / 4.85 inch Nota : 2WD	05135731AC, 5135731AA 5135731AB, 5135731AC
	<b>JP4001</b> Tornillo Estabilizador	Peso : 0,403 kg / 0.888 lb Tipo de Material : Metal Longitud : 177 mm / 6.97 inch	52087863, 52088896AA 52106303A, 52106303AA 52106306AA
	<b>DO11010</b> Buje De Horquilla & Tijera	Chasis (Delantero / Trasero) : Delantero Posicion : Superior Peso : 0.221 kg / 0.487 lb	52106580AB, MB00A868430
	<b>DO11010K</b> Buje De Horquilla & Tijera	Chasis (Delantero / Trasero) : Delantero Posicion : Superior Peso : 0.442 kg / 0.974 lb Nota : YCT13566 X 2	52106580AB, MB00A868430

**SPACE STAR I 1998 - 2004**





Imagen	Clave del Producto y Descripción	Detalles	OEM
	<b>MI11019</b> Buje De Horquilla & Tijera	Chasis (Delantero / Trasero) : Trasera Posicion : Inferior Chico Peso : 0.15 kg / 0.331 lb Nota : Pequeña	Part of MB809222, Part of MB809223 Part of MB910841, Part of MB910842 Part of MR491347, Part of MR491348

\* Nombres de los vehículos, marcas, modelos, símbolos y logos, número OE y otros números de terceros en el sitio web y catálogo solo son con fines de referencia.

**SPACE STAR**
**I**
**1998 - 2004**

Imagen	Clave del Producto y Descripción	Detalles	OEM
	<b>MI11020</b> Buje De Horquilla & Tijera	Chasis (Delantero / Trasero) : Trasera Posicion : Inferior Grande Peso : 0.22 kg / 0.485 lb Nota : Grande	Part of MB809222, Part of MB809223 Part of MB910841, Part of MB910842 Part of MR491347, Part of MR491348

**SPACE STAR**
**II**
**2012 -**

Imagen	Clave del Producto y Descripción	Detalles	OEM
	<b>MI1026</b> Rotula	Peso : 0,252 kg / 0.556 lb	4013A309*, 4013A310*
	<b>MI3024</b> Terminal interior	Peso : 0,568 kg / 1.252 lb Longitud : 344 mm / 13.54 inch	4422A098
	<b>MI6048</b> Horquilla & Tijera	Peso : 2,507 kg / 5.527 lb Tipo de Material : Chapa Metálica	4013A310
	<b>MI6049</b> Horquilla & Tijera	Peso : 2,507 kg / 5.527 lb Tipo de Material : Chapa Metálica	4013A309

**SPACE WAGON**
**N30, N40**
**1991 - 1997**

Imagen	Clave del Producto y Descripción	Detalles	OEM
	<b>MI4037</b> Tornillo Estabilizador	Peso : 0,210 kg / 0.463 lb Longitud : 140 mm / 5.51 inch Nota : FOR SPORT MODEL	4056A138, MR344624 MR555883, MR586053

**SPACE WAGON**
**N50**
**1997 - 2003**

Imagen	Clave del Producto y Descripción	Detalles	OEM
	<b>MI4037</b> Tornillo Estabilizador	Peso : 0,210 kg / 0.463 lb Longitud : 140 mm / 5.51 inch Nota : FOR SPORT MODEL	4056A138, MR344624 MR555883, MR586053
	<b>MI4038</b> Tornillo Estabilizador	Peso : 0,398 kg / 0.877 lb Tipo de Material : Metal Longitud : 240 mm / 9.45 inch	4056A035, MR316436

\* Nombres de los vehículos, marcas, modelos, símbolos y logos, número OE y otros números de terceros en el sitio web y catálogo solo son con fines de referencia.

**SPACE WAGON**
**N50**
**1997 - 2003**

Imagen	Clave del Producto y Descripción	Detalles	OEM
	<b>MI4039</b> Tornillo Estabilizador	Peso : 0,398 kg / 0.877 lb Tipo de Material : Metal Longitud : 240 mm / 9.45 inch	4056A034, MR316435

**STARION**
**1983 - 1985**

Imagen	Clave del Producto y Descripción	Detalles	OEM
	<b>CD4005</b> Tornillo Estabilizador	Peso : 0,220 kg / 0.485 lb Longitud : 145 mm / 5.71 inch	25679063, 3879218
	<b>MI4037</b> Tornillo Estabilizador	Peso : 0,210 kg / 0.463 lb Longitud : 140 mm / 5.51 inch Nota : FOR SPORT MODEL	4056A138, MR344624 MR555883, MR586053

**STARION**
**1986 - 1991**

Imagen	Clave del Producto y Descripción	Detalles	OEM
	<b>CD4005</b> Tornillo Estabilizador	Peso : 0,220 kg / 0.485 lb Longitud : 145 mm / 5.71 inch	25679063, 3879218
	<b>MI4037</b> Tornillo Estabilizador	Peso : 0,210 kg / 0.463 lb Longitud : 140 mm / 5.51 inch Nota : FOR SPORT MODEL	4056A138, MR344624 MR555883, MR586053

**RIW<sup>®</sup>**

**NISSAN**

**200SX** **1977 - 1979**

Imagen	Clave del Producto y Descripción	Detalles	OEM
	<b>CD4005</b> Tornillo Estabilizador	Peso : 0,220 kg / 0.485 lb Longitud : 145 mm / 5.71 inch	25679063, 3879218

**200SX** **S14** **1995 - 1999**

Imagen	Clave del Producto y Descripción	Detalles	OEM
	<b>NS3037</b> Terminal interior	Peso : 0,460 kg / 1.014 lb Longitud : 275,8 mm / 10.86 inch	4852165F01, 4852165F25

**350Z** **Z33** **2003 - 2009**

Imagen	Clave del Producto y Descripción	Detalles	OEM
	<b>NS5001</b> Horquilla & Tijera	Peso : 1,400 kg / 3.086 lb Tipo de Material : Aluminio	54500-AM601
	<b>NS5002</b> Horquilla & Tijera	Peso : 1,400 kg / 3.086 lb Tipo de Material : Aluminio	54501-AM601

**ALMERA** **I N15** **1995 - 2000**

Imagen	Clave del Producto y Descripción	Detalles	OEM
	<b>NS3037</b> Terminal interior	Peso : 0,460 kg / 1.014 lb Longitud : 275,8 mm / 10.86 inch	4852165F01, 4852165F25
	<b>NS3038</b> Terminal interior	Peso : 0,420 kg / 0.926 lb Longitud : 275,2 mm / 10.83 inch Tamaño de la Rosca : M16X1 Diámetro de Cuerda del Perno : M12X1,25	485211M210, 485211M226

**ALTIMA** **L32A** **2006 - 2013**

Imagen	Clave del Producto y Descripción	Detalles	OEM
	<b>NS9001</b> Horquilla & Tijera	Peso : 0,648 kg / 1.429 lb Tipo de Material : Tubo De Acero	551A0JA000

\* Nombres de los vehículos, marcas, modelos, símbolos y logos, número OE y otros números de terceros en el sitio web y catálogo solo son con fines de referencia.

**ALTIMA L33 2013 - 2015**

Imagen	Clave del Producto y Descripción	Detalles	OEM
	<b>NS6078</b> Horquilla & Tijera	Peso : 3,250 kg / 7.165 lb Tipo de Material : Aluminio	545003TA0A, 545003TA0B
	<b>NS6079</b> Horquilla & Tijera	Peso : 3,250 kg / 7.165 lb Tipo de Material : Aluminio	545013TA0A, 545013TA0B

**ALTIMA L33 FACELIFT 2016 - 2018**

Imagen	Clave del Producto y Descripción	Detalles	OEM
	<b>NS6080</b> Horquilla & Tijera	Peso : 3,250 kg / 7.165 lb Tipo de Material : Aluminio	545009HP0A
	<b>NS6081</b> Horquilla & Tijera	Peso : 3,250 kg / 7.165 lb Tipo de Material : Aluminio	545019HP0A

**ARMADA 2004 - 2015**

Imagen	Clave del Producto y Descripción	Detalles	OEM
	<b>NS11022K</b> Buje De Horquilla & Tijera	Chasis (Delantero / Trasero) : Delantero Posicion : Peso : 0,492 kg / 1.085 lb	
	<b>NS11023K</b> Buje De Horquilla & Tijera	Posicion : Peso : 0,624 kg / 1.376 lb	

**FRONTIER D40 2005 - 2015**

Imagen	Clave del Producto y Descripción	Detalles	OEM
	<b>NS4076</b> Tornillo Estabilizador	Peso : 0,186 kg / 0.410 lb Longitud : 139 mm / 5.47 inch	1015993, 546188B501 546198B400

**INTERSTAR X70 2002 - 2010**

Imagen	Clave del Producto y Descripción	Detalles	OEM
	<b>RN6013J</b> Horquilla & Tijera	Peso : 8,300 kg / 18.298 lb Tipo de Material : Döküm Çelik	4400048, 4404048 4500093, 5450000QAC 54500-00QAD, 5450000QAE 7700302119, 7700309190 8200767822, 8200767825
	<b>RN6014J</b> Horquilla & Tijera	Peso : 8,300 kg / 18.298 lb Tipo de Material : Döküm Çelik	4400048, 4404048 4500093, 5450000QAC 54500-00QAD, 5450000QAE 7700302119, 7700309190 8200767822, 8200767825
	<b>RN12183</b> Buje De Torsion	Chasis (Delantero / Trasero) : Trasera Posicion : Izquierda Y Derecha Peso : 0,200 kg / 0.441 lb Tipo de Material : Rubber	5000392657
	<b>RN13022K</b> Cubre Polvo De Direccion	Peso : 0.152 kg / 0.335 lb	4501260, 6001547607 6025 370 231, 6025370231 9161560

**MAXIMA A36 2015 -**

Imagen	Clave del Producto y Descripción	Detalles	OEM
	<b>NS6078</b> Horquilla & Tijera	Peso : 3,250 kg / 7.165 lb Tipo de Material : Aluminio	545003TA0A, 545003TA0B
	<b>NS6079</b> Horquilla & Tijera	Peso : 3,250 kg / 7.165 lb Tipo de Material : Aluminio	545013TA0A, 545013TA0B

**NAVARA D23 2015 -**

Imagen	Clave del Producto y Descripción	Detalles	OEM
	<b>ME1029</b> Rotula	Peso : 0,668 kg / 1.473 lb Diámetro del Cuerpo de la Rotu : Ø43,3	4703300700*, 4703301000* 54500-5XA0A*, 54501-5XA0A* A4703300700*, A4703301000*
	<b>ME4107</b> Tornillo Estabilizador	Peso : 0,383 kg / 0.844 lb Tipo de Material : Metal Longitud : 70 mm / 2.76 inch	4703202300, 54618-4KH0A 54618-5XA0A, A4703202300
	<b>ME4108</b> Tornillo Estabilizador	Peso : 0,383 kg / 0.844 lb Tipo de Material : Metal Longitud : 70 mm / 2.76 inch	4703202200, 54668-4KH0A 54668-5XA0A, A4703202200

\* Nombres de los vehículos, marcas, modelos, símbolos y logos, número OE y otros números de terceros en el sitio web y catálogo solo son con fines de referencia.

**NAVARA D23 2015 -**

Imagen	Clave del Producto y Descripción	Detalles	OEM
	<b>ME4109</b> Tornillo Estabilizador	Peso : 0,508 kg / 1.120 lb Tipo de Material : Metal Longitud : 210 mm / 8.27 inch Nota : Metal	4703260100, 562614KH0A 562615XA0A

**NAVARA D40 2005 - 2009**

Imagen	Clave del Producto y Descripción	Detalles	OEM
	<b>NS11022K</b> Buje De Horquilla & Tijera	Chasis (Delantero / Trasero) : Delantero Posicion : Peso : 0,492 kg / 1.085 lb	

**NAVARA D40 FACELIFT 2010 - 2016**

Imagen	Clave del Producto y Descripción	Detalles	OEM
	<b>NS11022K</b> Buje De Horquilla & Tijera	Chasis (Delantero / Trasero) : Delantero Posicion : Peso : 0,492 kg / 1.085 lb	

**PATHFINDER R51 2005 - 2014**

Imagen	Clave del Producto y Descripción	Detalles	OEM
	<b>NS1041</b> Rotula	Peso : 0,670 kg / 1.477 lb	551A0-EB300*, 551A0-EB31A*
	<b>NS11022K</b> Buje De Horquilla & Tijera	Chasis (Delantero / Trasero) : Delantero Posicion : Peso : 0,492 kg / 1.085 lb	

**PATROL Y60 1988 - 1997**

Imagen	Clave del Producto y Descripción	Detalles	OEM
	<b>NS2073</b> Terminal Exterior	Peso : 1,147 kg / 2.529 lb Longitud : 122,5 mm / 4.82 inch	48520-01J10
	<b>NS2074</b> Terminal Exterior	Peso : 1,147 kg / 2.529 lb Longitud : 122,5 mm / 4.82 inch	48570-01J10

\* Nombres de los vehículos, marcas, modelos, símbolos y logos, número OE y otros números de terceros en el sitio web y catálogo solo son con fines de referencia.



**PATROL Y61 1998 - 2013**

Imagen	Clave del Producto y Descripción	Detalles	OEM
	<b>NS2070</b> Terminal Exterior	Peso : 0,592 kg / 1.305 lb Longitud : 115 mm / 4.53 inch	48681VB025
	<b>NS2071</b> Terminal Exterior	Peso : 1,104 kg / 2.434 lb Longitud : 181 mm / 7.13 inch	D8520VS42A
	<b>NS2072</b> Terminal Exterior	Peso : 1,104 kg / 2.434 lb Longitud : 181 mm / 7.13 inch	D8570VS42A

**PRIMASTAR X83 2002 - 2014**

Imagen	Clave del Producto y Descripción	Detalles	OEM
	<b>RN12167K</b> Goma De Barra Estabilizadora	Posicion : Izquierda Y Derecha Peso : 0.15 kg / 0.331 lb Nota : 2 Pieces	4408905, 4417971 4418991, 4418992 8200048177, 8200629180 8200845492, 91166695 93861802, 93861803
	<b>RN13011K</b> Cubre Polvo De Direccion	Peso : 0.16 kg / 0.353 lb	7701472765, 7701473334

**PRIMERA P12 2002 - 2008**

Imagen	Clave del Producto y Descripción	Detalles	OEM
	<b>NS3036</b> Terminal interior	Peso : 0,497 kg / 1.096 lb Longitud : 275,4 mm / 10.84 inch	48521AU000

**QASHQAI I J10, JJ10 2007 - 2014**

Imagen	Clave del Producto y Descripción	Detalles	OEM
	<b>NS13006K</b> Cubre Polvo De Direccion	Peso : 0.1 kg / 0.220 lb	48203-JD01A

**TEANA**

**I J31**

**2004 - 2008**

Imagen	Clave del Producto y Descripción	Detalles	OEM
	<p><b>NS6082</b> Horquilla &amp; Tijera</p>	<p>Peso : 4,820 kg / 10.626 lb Tipo de Material : Chapa Metálica</p>	<p>545009W20C</p>
	<p><b>NS6083</b> Horquilla &amp; Tijera</p>	<p>Peso : 4,820 kg / 10.626 lb Tipo de Material : Chapa Metálica</p>	<p>545009W20C</p>

\* Nombres de los vehículos, marcas, modelos, símbolos y logos, número OE y otros números de terceros en el sitio web y catálogo solo son con fines de referencia.

**NS8001 / Kit De Suspension Y Direccion**

**TIIDA**

**C11**

**2004 - 2012**

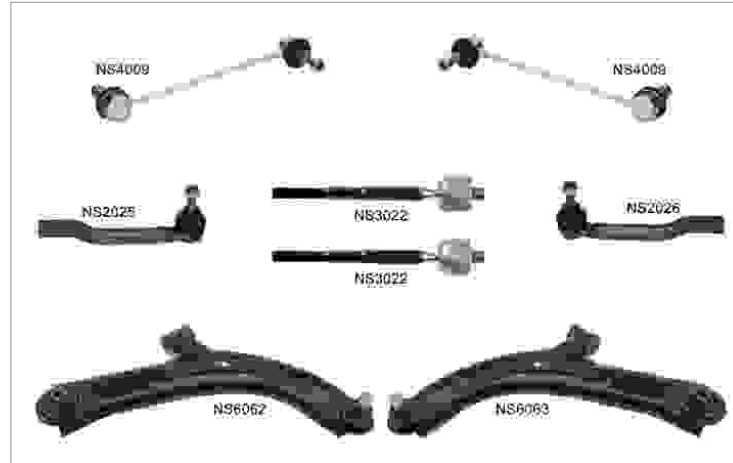

**Piezas del Kit**

Imagen	RIWCodigo / Nombre	OEM	OEM	RIWCodigo / Nombre	Imagen
	<b>NS2025</b> Terminal Exterior Frontal Derecho	485271U61A, 48657-1U61A D8520-EW00A	486471U61A, 48647-1U61A D8640-EW00A	<b>NS2026</b> Terminal Exterior Frontal Izquierdo	
	<b>NS3022</b> Terminal Interior Delantero	48521-3U025	54618-1X30A, 54618-9U00A 54618-BC40A	<b>NS4009</b> Tornillo Estabilizador Delantero	
	<b>NS6062</b> Horquillas Frontal Derecho Inferior	54500-1FU0B, 54500-1JY0A 54500-ED50A, 54500-EL000 54500-EL00A, 54500-EL00D 54500-ET000, 54500-EW000	54501-1FU0B, 54501-1JY0A 54501-EL000, 54501-EL00A 54501-EL00D, 54501-ET000 54501-EW000	<b>NS6063</b> Horquillas Frontal Inferior Izquierdo	

\* Nombres de los vehiculos, marcas, modelos, simbolos y logotipos, numero OE y otros numeros de terceros en el sitio web y catalogo solo son con fines de referencia.

**NS8001 / Kit De Suspension Y Direccion**

**TIIDA**

**HATCHBACK C11X**

**2007 - 2015**

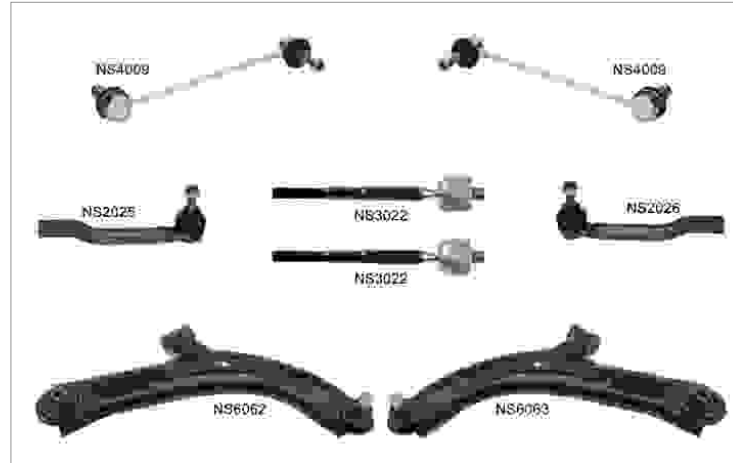

**Piezas del Kit**

Imagen	RIWCodigo / Nombre	OEM	OEM	RIWCodigo / Nombre	Imagen
	<b>NS2025</b> Terminal Exterior Frontal Derecho	485271U61A, 48657-1U61A D8520-EW00A	486471U61A, 48647-1U61A D8640-EW00A	<b>NS2026</b> Terminal Exterior Frontal Izquierdo	
	<b>NS3022</b> Terminal Interior Delantero	48521-3U025	54618-1X30A, 54618-9U00A 54618-BC40A	<b>NS4009</b> Tornillo Estabilizador Delantero	
	<b>NS6062</b> Horquillas Frontal Derecho Inferior	54500-1FU0B, 54500-1JY0A 54500-ED50A, 54500-EL000 54500-EL00A, 54500-EL00D 54500-ET000, 54500-EW000	54501-1FU0B, 54501-1JY0A 54501-EL000, 54501-EL00A 54501-EL00D, 54501-ET000 54501-EW000	<b>NS6063</b> Horquillas Frontal Inferior Izquierdo	

\* Nombres de los vehiculos, marcas, modelos, simbolos y logos, numero OE y otros numeros de terceros en el sitio web y catalogo solo son con fines de referencia.

**TITAN**
**2004 - 2015**

Imagen	Clave del Producto y Descripción	Detalles	OEM
	<b>NS11022K</b> Buje De Horquilla & Tijera	Chasis (Delantero / Trasero) : Delantero Posicion : Peso : 0,492 kg / 1.085 lb	

**XTERRA**
**2005 - 2018**

Imagen	Clave del Producto y Descripción	Detalles	OEM
	<b>NS11022K</b> Buje De Horquilla & Tijera	Chasis (Delantero / Trasero) : Delantero Posicion : Peso : 0,492 kg / 1.085 lb	

**X-TRAIL**
**T31**
**2007 - 2013**

Imagen	Clave del Producto y Descripción	Detalles	OEM
	<b>NS13006K</b> Cubre Polvo De Direccion	Peso : 0.1 kg / 0.220 lb	48203-JD01A

**RIW<sup>®</sup>**

**OLDSMOBILE**

**98**
**1971 - 1976**

Imagen	Clave del Producto y Descripción	Detalles	OEM
	<b>CV1034</b> RÓTULA FRONTAL INFERIOR	Peso : 0,913 kg / 2.013 lb	7808865, 7814131 88965475, 9754378 9761498, 9766421
	<b>CD4005</b> Tornillo Estabilizador	Peso : 0,220 kg / 0.485 lb Longitud : 145 mm / 5.71 inch	25679063, 3879218

**98**
**1977 - 1984**

Imagen	Clave del Producto y Descripción	Detalles	OEM
	<b>CD4004</b> Tornillo Estabilizador	Peso : 0,264 kg / 0.582 lb Longitud : 184 mm / 7.24 inch	10023178, 10164176 C1VY5A484A
	<b>CD4005</b> Tornillo Estabilizador	Peso : 0,220 kg / 0.485 lb Longitud : 145 mm / 5.71 inch	25679063, 3879218

**98**
**1985 - 1990**

Imagen	Clave del Producto y Descripción	Detalles	OEM
	<b>CD4005</b> Tornillo Estabilizador	Peso : 0,220 kg / 0.485 lb Longitud : 145 mm / 5.71 inch	25679063, 3879218

**98**
**1991 - 1996**

Imagen	Clave del Producto y Descripción	Detalles	OEM
	<b>CD4005</b> Tornillo Estabilizador	Peso : 0,220 kg / 0.485 lb Longitud : 145 mm / 5.71 inch	25679063, 3879218

**ACHIEVA**
**1992 - 1998**

Imagen	Clave del Producto y Descripción	Detalles	OEM
	<b>CD4004</b> Tornillo Estabilizador	Peso : 0,264 kg / 0.582 lb Longitud : 184 mm / 7.24 inch	10023178, 10164176 C1VY5A484A

\* Nombres de los vehículos, marcas, modelos, símbolos y logos, número OE y otros números de terceros en el sitio web y catálogo solo son con fines de referencia.

**ALERO**
**1999 - 2004**

Imagen	Clave del Producto y Descripción	Detalles	OEM
	<b>CV1036</b> Rotula	Peso : 0,548 kg / 1.208 lb	10365842*, 22157023* 88967438*
	<b>CV4057</b> Tornillo Estabilizador	Peso : 0.188 kg / 0.414 lb Tipo de Material : Metal	22601062
	<b>CV4058</b> Tornillo Estabilizador	Peso : 0.188 kg / 0.414 lb Tipo de Material : Metal	22601060

**AURORA**
**1995 - 1999**

Imagen	Clave del Producto y Descripción	Detalles	OEM
	<b>CV3030</b> Terminal interior	Peso : 0,647 kg / 1.426 lb Longitud : 324,5 mm / 12.78 inch	26003751, 26003759 26012282, 26021769
	<b>CD4005</b> Tornillo Estabilizador	Peso : 0,220 kg / 0.485 lb Longitud : 145 mm / 5.71 inch	25679063, 3879218

**AURORA**
**2000 - 2003**

Imagen	Clave del Producto y Descripción	Detalles	OEM
	<b>CV3030</b> Terminal interior	Peso : 0,647 kg / 1.426 lb Longitud : 324,5 mm / 12.78 inch	26003751, 26003759 26012282, 26021769
	<b>CD4005</b> Tornillo Estabilizador	Peso : 0,220 kg / 0.485 lb Longitud : 145 mm / 5.71 inch	25679063, 3879218

**BRAVADA**
**1996 - 2001**

Imagen	Clave del Producto y Descripción	Detalles	OEM
	<b>CV4055</b> Tornillo Estabilizador	Peso : 0,320 kg / 0.705 lb Longitud : 118 mm / 4.65 inch	15996064

\* Nombres de los vehículos, marcas, modelos, símbolos y logos, número OE y otros números de terceros en el sitio web y catálogo solo son con fines de referencia.



**BRAVADA**
**2002 - 2004**

Imagen	Clave del Producto y Descripción	Detalles	OEM
	<b>CV3035</b> Terminal interior	Peso : 0,534 kg / 1.177 lb Longitud : 135 mm / 5.31 inch	26100288, 8261002880

**CUSTOM CRUISER**
**1971 - 1976**

Imagen	Clave del Producto y Descripción	Detalles	OEM
	<b>CV1034</b> RÓTULA FRONTAL INFERIOR	Peso : 0,913 kg / 2.013 lb	7808865, 7814131 88965475, 9754378 9761498, 9766421
	<b>CV4056</b> Tornillo Estabilizador	Peso : 0,182 kg / 0.401 lb Longitud : 195,5 mm / 7.70 inch	25784241

**CUSTOM CRUISER**
**1977 - 1990**

Imagen	Clave del Producto y Descripción	Detalles	OEM
	<b>CD4004</b> Tornillo Estabilizador	Peso : 0,264 kg / 0.582 lb Longitud : 184 mm / 7.24 inch	10023178, 10164176 C1VY5A484A

**CUTLASS**
**II**
**1964 - 1967**

Imagen	Clave del Producto y Descripción	Detalles	OEM
	<b>CV4056</b> Tornillo Estabilizador	Peso : 0,182 kg / 0.401 lb Longitud : 195,5 mm / 7.70 inch	25784241

**CUTLASS**
**III**
**1968 - 1972**

Imagen	Clave del Producto y Descripción	Detalles	OEM
	<b>CV4056</b> Tornillo Estabilizador	Peso : 0,182 kg / 0.401 lb Longitud : 195,5 mm / 7.70 inch	25784241

**CUTLASS IV 1973 - 1977**

Imagen	Clave del Producto y Descripción	Detalles	OEM
	<b>CD4004</b> Tornillo Estabilizador	Peso : 0,264 kg / 0.582 lb Longitud : 184 mm / 7.24 inch	10023178, 10164176 C1VY5A484A

**CUTLASS VI 1997 - 1999**

Imagen	Clave del Producto y Descripción	Detalles	OEM
	<b>CV4057</b> Tornillo Estabilizador	Peso : 0.188 kg / 0.414 lb Tipo de Material : Metal	22601062
	<b>CV4058</b> Tornillo Estabilizador	Peso : 0.188 kg / 0.414 lb Tipo de Material : Metal	22601060

**CUTLASS CALAIS 1985 - 1991**

Imagen	Clave del Producto y Descripción	Detalles	OEM
	<b>CD4004</b> Tornillo Estabilizador	Peso : 0,264 kg / 0.582 lb Longitud : 184 mm / 7.24 inch	10023178, 10164176 C1VY5A484A

**DELTA 88 1971 - 1976**

Imagen	Clave del Producto y Descripción	Detalles	OEM
	<b>CV1034</b> RÓTULA FRONTAL INFERIOR	Peso : 0,913 kg / 2.013 lb	7808865, 7814131 88965475, 9754378 9761498, 9766421

**DELTA 88 1977 - 1985**

Imagen	Clave del Producto y Descripción	Detalles	OEM
	<b>CD4004</b> Tornillo Estabilizador	Peso : 0,264 kg / 0.582 lb Longitud : 184 mm / 7.24 inch	10023178, 10164176 C1VY5A484A

**DELTA 88**
**1986 - 1991**

Imagen	Clave del Producto y Descripción	Detalles	OEM
	<b>CD4005</b> Tornillo Estabilizador	Peso : 0,220 kg / 0.485 lb Longitud : 145 mm / 5.71 inch	25679063, 3879218

**DELTA 88**
**1992 - 1999**

Imagen	Clave del Producto y Descripción	Detalles	OEM
	<b>CD4005</b> Tornillo Estabilizador	Peso : 0,220 kg / 0.485 lb Longitud : 145 mm / 5.71 inch	25679063, 3879218

**F85**
**II**
**1964 - 1965**

Imagen	Clave del Producto y Descripción	Detalles	OEM
	<b>CV4056</b> Tornillo Estabilizador	Peso : 0,182 kg / 0.401 lb Longitud : 195,5 mm / 7.70 inch	25784241

**F85**
**III**
**1966 - 1967**

Imagen	Clave del Producto y Descripción	Detalles	OEM
	<b>CV4056</b> Tornillo Estabilizador	Peso : 0,182 kg / 0.401 lb Longitud : 195,5 mm / 7.70 inch	25784241

**F85**
**IV**
**1968 - 1972**

Imagen	Clave del Producto y Descripción	Detalles	OEM
	<b>CV4056</b> Tornillo Estabilizador	Peso : 0,182 kg / 0.401 lb Longitud : 195,5 mm / 7.70 inch	25784241

**FIRENZA**
**1983 - 1988**

Imagen	Clave del Producto y Descripción	Detalles	OEM
	<b>CD4004</b> Tornillo Estabilizador	Peso : 0,264 kg / 0.582 lb Longitud : 184 mm / 7.24 inch	10023178, 10164176 C1VY5A484A

\* Nombres de los vehículos, marcas, modelos, símbolos y logos, número OE y otros números de terceros en el sitio web y catálogo solo son con fines de referencia.

**INTRIGUE**
**1998 - 2002**

Imagen	Clave del Producto y Descripción	Detalles	OEM
	<b>CV3030</b> Terminal interior	Peso : 0,647 kg / 1.426 lb Longitud : 324,5 mm / 12.78 inch	26003751, 26003759 26012282, 26021769

**JETSTAR 88**
**II**
**1964 - 1964**

Imagen	Clave del Producto y Descripción	Detalles	OEM
	<b>CD4005</b> Tornillo Estabilizador	Peso : 0,220 kg / 0.485 lb Longitud : 145 mm / 5.71 inch	25679063, 3879218

**JETSTAR 88**
**III**
**1965 - 1966**

Imagen	Clave del Producto y Descripción	Detalles	OEM
	<b>CD4005</b> Tornillo Estabilizador	Peso : 0,220 kg / 0.485 lb Longitud : 145 mm / 5.71 inch	25679063, 3879218

**LSS**
**1996 - 1999**

Imagen	Clave del Producto y Descripción	Detalles	OEM
	<b>CD4005</b> Tornillo Estabilizador	Peso : 0,220 kg / 0.485 lb Longitud : 145 mm / 5.71 inch	25679063, 3879218

**OMEGA**
**I**
**1973 - 1974**

Imagen	Clave del Producto y Descripción	Detalles	OEM
	<b>CV4056</b> Tornillo Estabilizador	Peso : 0,182 kg / 0.401 lb Longitud : 195,5 mm / 7.70 inch	25784241

**OMEGA**
**II**
**1975 - 1979**

Imagen	Clave del Producto y Descripción	Detalles	OEM
	<b>CD4004</b> Tornillo Estabilizador	Peso : 0,264 kg / 0.582 lb Longitud : 184 mm / 7.24 inch	10023178, 10164176 C1VY5A484A

\* Nombres de los vehículos, marcas, modelos, símbolos y logos, número OE y otros números de terceros en el sitio web y catálogo solo son con fines de referencia.

**STARFIRE 1961 - 1966**

Imagen	Clave del Producto y Descripción	Detalles	OEM
	<b>CD4005</b> Tornillo Estabilizador	Peso : 0,220 kg / 0.485 lb Longitud : 145 mm / 5.71 inch	25679063, 3879218

**STARFIRE 1975 - 1980**

Imagen	Clave del Producto y Descripción	Detalles	OEM
	<b>CD4004</b> Tornillo Estabilizador	Peso : 0,264 kg / 0.582 lb Longitud : 184 mm / 7.24 inch	10023178, 10164176 C1VY5A484A

**TORONADO III 1979 - 1985**

Imagen	Clave del Producto y Descripción	Detalles	OEM
	<b>CD4005</b> Tornillo Estabilizador	Peso : 0,220 kg / 0.485 lb Longitud : 145 mm / 5.71 inch	25679063, 3879218

**TORONADO IV 1986 - 1992**

Imagen	Clave del Producto y Descripción	Detalles	OEM
	<b>CD4005</b> Tornillo Estabilizador	Peso : 0,220 kg / 0.485 lb Longitud : 145 mm / 5.71 inch	25679063, 3879218

**VISTA CRUISER II 1970 - 1971**



Imagen	Clave del Producto y Descripción	Detalles	OEM
	<b>CV4056</b> Tornillo Estabilizador	Peso : 0,182 kg / 0.401 lb Longitud : 195,5 mm / 7.70 inch	25784241

**VISTA CRUISER III 1972 - 1972**

Imagen	Clave del Producto y Descripción	Detalles	OEM
	<b>CV4056</b> Tornillo Estabilizador	Peso : 0,182 kg / 0.401 lb Longitud : 195,5 mm / 7.70 inch	25784241

\* Nombres de los vehículos, marcas, modelos, símbolos y logos, número OE y otros números de terceros en el sitio web y catálogo solo son con fines de referencia.

**VISTA CRUISER**
**IV**
**1973 - 1977**

Imagen	Clave del Producto y Descripción	Detalles	OEM
	<b>CD4004</b> Tornillo Estabilizador	Peso : 0,264 kg / 0.582 lb Longitud : 184 mm / 7.24 inch	10023178, 10164176 C1VY5A484A
	<b>CV4056</b> Tornillo Estabilizador	Peso : 0,182 kg / 0.401 lb Longitud : 195,5 mm / 7.70 inch	25784241

**RIW<sup>®</sup>**

**OPEL**

**ADAM**
**2012 - 2019**

Imagen	Clave del Producto y Descripción	Detalles	OEM
	<b>VX12011</b> Soporte De Motor	Chasis (Delantero / Trasero) : Delantero Peso : 1,720 kg / 3.792 lb	13130739, 13234039 5684196, 5684205
	<b>FI13016K</b> Cubre Polvo De Direccion	Peso : 0.164 kg / 0.362 lb	4066.95, 77363828 77364571

**ASTRA**
**F**
**1991 - 1998**

Imagen	Clave del Producto y Descripción	Detalles	OEM
	<b>VX12032</b> Soporte De Amortiguador	Chasis (Delantero / Trasero) : Delantero Peso : 0.258 kg / 0.569 lb	312509, 90375348
	<b>VX12001</b> Soporte De Motor	Chasis (Delantero / Trasero) : Delantero Posicion : Izquierdo Peso : 0,590 kg / 1.301 lb	684643, 90372699
	<b>VX12002</b> Soporte De Motor	Chasis (Delantero / Trasero) : Delantero Posicion : Derecha Peso : 0,610 kg / 1.345 lb	684644, 90335498

**ASTRA**
**G**
**1998 - 2004**

Imagen	Clave del Producto y Descripción	Detalles	OEM
	<b>OP3035</b> Terminal interior	Peso : 0,570 kg / 1.257 lb Longitud : 284 mm / 11.18 inch	1603003, 1603644
	<b>VX12031</b> Soporte De Motor	Chasis (Delantero / Trasero) : Delantero Peso : 0,881 kg / 1.942 lb	24459788, 24459817 684535, 90538549

**ASTRA**
**H**
**2004 - 2009**

Imagen	Clave del Producto y Descripción	Detalles	OEM
	<b>OP11024K</b> Buje De Torsion	Posicion : Izquierda Y Derecha Peso : 0.784 kg / 1.728 lb Nota : 2 Piezas	13110418, 13267215 402952, 5402637

\* Nombres de los vehiculos, marcas, modelos, simbolos y logos, numero OE y otros numeros de terceros en el sitio web y catalogo solo son con fines de referencia.











**ASTRA**
**H**
**2004 - 2009**

Imagen	Clave del Producto y Descripción	Detalles	OEM
	<b>VX12018</b> Soporte De Motor	Peso : 0,950 kg / 2.094 lb	24459797, 5684136
	<b>VX12031</b> Soporte De Motor	Chasis (Delantero / Trasero) : Delantero Peso : 0,881 kg / 1.942 lb	24459788, 24459817 684535, 90538549

**ASTRA**
**J**
**2009 - 2015**

Imagen	Clave del Producto y Descripción	Detalles	OEM
	<b>VX12012</b> Soporte De Motor	Posicion : Derecha Peso : 2,120 kg / 4.674 lb	13347451, 684137 684321, 684435
	<b>VX12013</b> Soporte De Motor	Posicion : Derecha Peso : 1,970 kg / 4.343 lb	13294212, 13347449 684223, 684315 684411
	<b>VX12014</b> Soporte De Motor	Posicion : Derecha Peso : 2,000 kg / 4.409 lb	13248476, 13347450 684135, 684320
	<b>VX12016</b> Soporte De Motor	Posicion : Derecha Peso : 1,655 kg / 3.649 lb	13248549, 682065
	<b>VX12017</b> Soporte De Motor	Posicion : Izquierdo Peso : 1,700 kg / 3.748 lb	13248544, 682050
	<b>VX12023</b> Soporte De Motor	Peso : 1,500 kg / 3.307 lb	13324496, 684300
	<b>VX12024</b> Soporte De Motor	Peso : 1,400 kg / 3.086 lb	13248599, 684215
	<b>VX12025</b> Soporte De Motor	Peso : 0,850 kg / 1.874 lb	13248600, 684216

\* Nombres de los vehículos, marcas, modelos, símbolos y logos, número OE y otros números de terceros en el sitio web y catálogo solo son con fines de referencia.

ASTRA		J		2009 - 2015	
Imagen	Clave del Producto y Descripción	Detalles	OEM		
	<b>VX12030</b> Soporte De Motor	Chasis (Delantero / Trasero) : Delantero Peso : 0,800 kg / 1.764 lb	13248575, 684214		
	<b>VX12033</b> Soporte De Motor	Chasis (Delantero / Trasero) : Delantero Peso : 1.67 kg / 3.682 lb Nota : HYDRAULIC	1387953, 682066		
	<b>VX12034</b> Soporte De Motor	Chasis (Delantero / Trasero) : Delantero Peso : 1,878 kg / 4.140 lb Nota : HYDRAULIC	13248550, 682076		
	<b>VX12035</b> Soporte De Motor	Chasis (Delantero / Trasero) : Delantero Peso : 1,657 kg / 3.653 lb Nota : HYDRAULIC	13248542, 682047		
	<b>VX12036</b> Soporte De Motor	Chasis (Delantero / Trasero) : Delantero Peso : 2,062 kg / 4.546 lb Nota : HYDRAULIC	13248545, 682063		
	<b>VX12037</b> Soporte De Motor	Chasis (Delantero / Trasero) : Delantero Peso : 1,905 kg / 4.200 lb Nota : HYDRAULIC	13248548, 682073		
	<b>VX12038</b> Soporte De Motor	Chasis (Delantero / Trasero) : Delantero Posicion : Superior Izquierdo Peso : 1,225 kg / 2.701 lb	13337422, 682075		
	<b>VX12039</b> Soporte De Motor	Chasis (Delantero / Trasero) : Delantero Posicion : Superior Izquierdo Peso : 1.65 kg / 3.638 lb	13248546, 682064		
	<b>VX12040</b> Soporte De Motor	Chasis (Delantero / Trasero) : Delantero Posicion : Superior Izquierdo Peso : 1.9 kg / 4.189 lb	13287957, 682067		







ASTRA		K		2015 - 2022	
Imagen	Clave del Producto y Descripción	Detalles	OEM		
	<b>OP20423031</b> Terminales Completas	Peso : 1,050 kg / 2.315 lb Terminal Exterior : OP2042 Terminal Interior : OP3031			

\* Nombres de los vehículos, marcas, modelos, símbolos y logos, número OE y otros números de terceros en el sitio web y catálogo solo son con fines de referencia.



**ASTRA**
**K**
**2015 - 2022**

Imagen	Clave del Producto y Descripción	Detalles	OEM
	<b>OP20433031</b> Terminales Completas	Peso : 1,050 kg / 2.315 lb Terminal Exterior : OP2043 Terminal Interior : OP3031	

**CASCADA**
**W13**
**2013 - 2019**

Imagen	Clave del Producto y Descripción	Detalles	OEM
	<b>VX12012</b> Soporte De Motor	Posicion : Derecha Peso : 2,120 kg / 4.674 lb	13347451, 684137 684321, 684435
	<b>VX12016</b> Soporte De Motor	Posicion : Derecha Peso : 1,655 kg / 3.649 lb	13248549, 682065
	<b>VX12017</b> Soporte De Motor	Posicion : Izquierdo Peso : 1,700 kg / 3.748 lb	13248544, 682050
	<b>VX12025</b> Soporte De Motor	Peso : 0,850 kg / 1.874 lb	13248600, 684216
	<b>VX12030</b> Soporte De Motor	Chasis (Delantero / Trasero) : Delantero Peso : 0,800 kg / 1.764 lb	13248575, 684214
	<b>VX12036</b> Soporte De Motor	Chasis (Delantero / Trasero) : Delantero Peso : 2,062 kg / 4.546 lb Nota : HYDRAULIC	13248545, 682063

**COMBO**
**C**
**2000 - 2006**

Imagen	Clave del Producto y Descripción	Detalles	OEM
	<b>VX12008</b> Soporte De Motor	Posicion : Izquierdo Peso : 2.1 kg / 4.630 lb Nota : HYDRAULIC	24463127, 5684173
	<b>OP13006K</b> Cubre Polvo De Direccion	Peso : 0.098 kg / 0.216 lb	1609121

\* Nombres de los vehículos, marcas, modelos, símbolos y logos, número OE y otros números de terceros en el sitio web y catálogo solo son con fines de referencia.

**CORSA****A****1982 - 1993**

Imagen	Clave del Producto y Descripción	Detalles	OEM
	<b>VX12003</b> Soporte De Amortiguador	Chasis (Delantero / Trasero) : Delantero Peso : 0,920 kg / 2.028 lb	344507, 344522 90445205

**OP8001 / Kit De Suspension Y Direccion**

**CORSA**

**C**

**2000 - 2006**

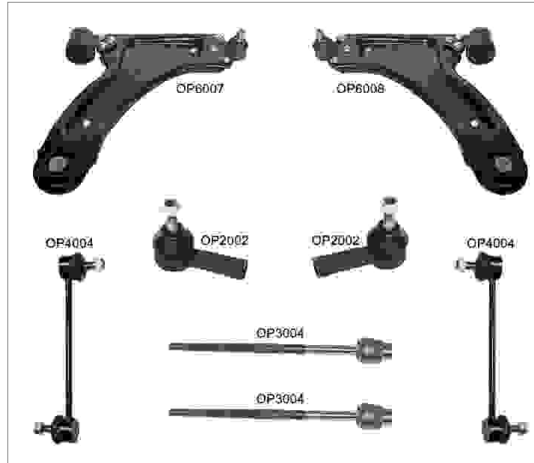



**Piezas del Kit**





Imagen	RIWCodigo / Nombre	OEM	OEM	RIWCodigo / Nombre	Imagen
	<b>OP2002</b> Terminal Exterior Delantero	1603009, 1603645 26011925, 26087868 324042, 324050 7840452	1603008, 26087867	<b>OP3004</b> Terminal Interior Delantero	
	<b>OP4004</b> Tornillo Estabilizador Delantero	350610, 4686606 4886606, 5236823 90496116	13140038, 24428978 352042, 352063	<b>OP6007</b> Horquillas Frontal Derecho Inferior	
	<b>OP6008</b> Horquillas Frontal Inferior Izquierdo	24428977, 352041 352061			

\* Nombres de los vehiculos, marcas, modelos, simbolos y logoss, numero OE y otros numeros de terceros en el sitio web y catalogo solo son con fines de referencia.

**CORSA C 2000 - 2006**

Imagen	Clave del Producto y Descripción	Detalles	OEM
	<b>VX12008</b> Soporte De Motor	Posicion : Izquierdo Peso : 2.1 kg / 4.630 lb Nota : HYDRAULIC	24463127, 5684173
	<b>OP13006K</b> Cubre Polvo De Direccion	Peso : 0.098 kg / 0.216 lb	1609121

**CORSA D 2006 - 2014**

Imagen	Clave del Producto y Descripción	Detalles	OEM
	<b>VX12010</b> Soporte De Motor	Peso : 1.4 kg / 3.086 lb	13234038, 5684203
	<b>VX12011</b> Soporte De Motor	Chasis (Delantero / Trasero) : Delantero Peso : 1,720 kg / 3.792 lb	13130739, 13234039 5684196, 5684205
	<b>VX12015</b> Soporte De Motor	Peso : 0,555 kg / 1.224 lb	13130724, 846837
	<b>FI13016K</b> Cubre Polvo De Direccion	Peso : 0.164 kg / 0.362 lb	4066.95, 77363828 77364571

**CORSA E 2014 - 2019**

Imagen	Clave del Producto y Descripción	Detalles	OEM
	<b>FI13016K</b> Cubre Polvo De Direccion	Peso : 0.164 kg / 0.362 lb	4066.95, 77363828 77364571

**INSIGNIA A 2008 - 2016**







Imagen	Clave del Producto y Descripción	Detalles	OEM
	<b>VX12022</b> Soporte De Motor	Peso : 0,840 kg / 1.852 lb	13227762, 684612 684613, 91050354

\* Nombres de los vehículos, marcas, modelos, símbolos y logos, número OE y otros números de terceros en el sitio web y catálogo solo son con fines de referencia.

**INSIGNIA A 2008 - 2016**

Imagen	Clave del Producto y Descripción	Detalles	OEM
	<b>VX12026</b> Soporte De Motor	Peso : 1,470 kg / 3.241 lb	13112029, 5684143
	<b>VX12028</b> Soporte De Motor	Chasis (Delantero / Trasero) : Delantero Peso : 0,830 kg / 1.830 lb	13227769, 684616
	<b>VX12029</b> Soporte De Motor	Chasis (Delantero / Trasero) : Delantero Posicion : Inferior Peso : 0,815 kg / 1.797 lb Nota : TRANSMISSION TYPE: M32-6	13227767, 684615

**INSIGNIA B 2017 -**

Imagen	Clave del Producto y Descripción	Detalles	OEM
	<b>OP2051</b> TERMINAL EXTERIOR FRONTAL DERECHO	Peso : 0,828 kg / 1.825 lb Longitud : 112 mm / 4.41 inch	23449523
	<b>OP2052</b> TERMINAL EXTERIOR FRONTAL IZQUIERDO	Peso : 0,828 kg / 1.825 lb Longitud : 112 mm / 4.41 inch	23449522
	<b>OP3034</b> Terminal interior	Peso : 0,564 kg / 1.243 lb Longitud : 244 mm / 9.61 inch Tamaño de la Rosca : M16X1,5 Diámetro de Cuerda del Perno : M14X1,5	23449526
	<b>OP4031</b> Tornillo Estabilizador	Peso : 0,394 kg / 0.869 lb Tipo de Material : Metal Longitud : 274 mm / 10.79 inch	23322794, 84077103
	<b>OP4032</b> Tornillo Estabilizador	Peso : 0,394 kg / 0.869 lb Tipo de Material : Metal Longitud : 274 mm / 10.79 inch	23322795, 84077102
	<b>OP4033</b> Tornillo Estabilizador	Peso : 0,276 kg / 0.608 lb Longitud : 100 mm / 3.94 inch Nota : FWD	23384634
	<b>OP11057</b> Buje De Horquilla & Tijera	Chasis (Delantero / Trasero) : Delantero Posicion : Inferior Grande Peso : 0.69 kg / 1.521 lb	23167662*, 84198829* 84198832*, 84198833*

\* Nombres de los vehículos, marcas, modelos, símbolos y logos, número OE y otros números de terceros en el sitio web y catálogo solo son con fines de referencia.



**INSIGNIA B 2017 -**

Imagen	Clave del Producto y Descripción	Detalles	OEM
	<b>OP11058</b> Buje De Horquilla & Tijera	Chasis (Delantero / Trasero) : Delantero Posicion : Inferior Chico Peso : 0.54 kg / 1.190 lb	23167662*, 84198829* 84198832*, 84198833*

**KARL C16 2015 -**

Imagen	Clave del Producto y Descripción	Detalles	OEM
	<b>OP3033</b> Terminal interior	Peso : 0,481 kg / 1.060 lb Longitud : 248 mm / 9.76 inch	1609224, 95371542

**MERIVA A 2003 - 2010**

Imagen	Clave del Producto y Descripción	Detalles	OEM
	<b>VX12008</b> Soporte De Motor	Posicion : Izquierdo Peso : 2.1 kg / 4.630 lb Nota : HYDRAULIC	24463127, 5684173
	<b>VX12009</b> Soporte De Motor	Posicion : Izquierdo Peso : 1,800 kg / 3.968 lb Nota : HYDRAULIC	13181023, 5684186

**MERIVA B 2010 - 2017**

Imagen	Clave del Producto y Descripción	Detalles	OEM
	<b>OP11024K</b> Buje De Torsion	Posicion : Izquierda Y Derecha Peso : 0.784 kg / 1.728 lb Nota : 2 Piezas	13110418, 13267215 402952, 5402637

**MOVANO A 1998 - 2010**

Imagen	Clave del Producto y Descripción	Detalles	OEM
	<b>RN6013J</b> Horquilla & Tijera	Peso : 8,300 kg / 18.298 lb Tipo de Material : Döküm Çelik	4400048, 4404048 4500093, 5450000QAC 54500-00QAD, 5450000QAE 7700302119, 7700309190 8200767822, 8200767825
	<b>RN6014J</b> Horquilla & Tijera	Peso : 8,300 kg / 18.298 lb Tipo de Material : Döküm Çelik	4400048, 4404048 4500093, 5450000QAC 54500-00QAD, 5450000QAE 7700302119, 7700309190 8200767822, 8200767825

\* Nombres de los vehículos, marcas, modelos, símbolos y logos, número OE y otros números de terceros en el sitio web y catálogo solo son con fines de referencia.



**MOVANO A 1998 - 2010**

Imagen	Clave del Producto y Descripción	Detalles	OEM
	<b>RN12183</b> Buje De Torsion	Chasis (Delantero / Trasero) : Trasera Posicion : Izquierda Y Derecha Peso : 0,200 kg / 0.441 lb Tipo de Material : Rubber	5000392657
	<b>RN13022K</b> Cubre Polvo De Direccion	Peso : 0.152 kg / 0.335 lb	4501260, 6001547607 6025 370 231, 6025370231 9161560

**MOVANO B 2010 -**

Imagen	Clave del Producto y Descripción	Detalles	OEM
	<b>RN13023</b> Cubre Polvo De Direccion	Peso : 0.14 kg / 0.309 lb Diámetro Grande : 94 Diámetro Pequeño : 75	4419289, 4422830 543880453R, 93197323 95517236

**OMEGA A 1986 - 1994**

Imagen	Clave del Producto y Descripción	Detalles	OEM
	<b>OP11005K</b> Buje De Horquilla & Tijera	Posicion : Izquierda Y Derecha Peso : 0,277 kg / 0.611 lb Nota : 2 Pieces	352342, 352343 352355, 90288207 90373854

**SENATOR B 1986 - 1994**

Imagen	Clave del Producto y Descripción	Detalles	OEM
	<b>OP11005K</b> Buje De Horquilla & Tijera	Posicion : Izquierda Y Derecha Peso : 0,277 kg / 0.611 lb Nota : 2 Pieces	352342, 352343 352355, 90288207 90373854

**OP8002 / Kit De Suspension Y Direccion**
**SIGNUM**
**Z03**
**2003 - 2008**

**Piezas del Kit**

Imagen	RIW Codigo / Nombre	OEM	OEM	RIW Codigo / Nombre	Imagen
	<b>OP2017</b> Terminal Exterior Frontal Derecho	1603228, 5235668 5239322, 77363712	12801423, 1603227 5235650, 5239314 77363713	<b>OP2018</b> Terminal Exterior Frontal Izquierdo	
	<b>OP3013</b> Terminal Interior Delantero	1603229, 1603351 1603415, 93172256	24417251, 350603 51741130	<b>OP4007</b> Tornillo Estabilizador Delantero	
	<b>OP6025</b> Horquillas Frontal Derecho Inferior	12796014, 12799200 352052, 51748652	12796013, 12799199 12799200, 352051 51748653	<b>OP6026</b> Horquillas Frontal Inferior Izquierdo	

<b>SIGNUM</b>		<b>Z03</b>		<b>2003 - 2008</b>	
Imagen	Clave del Producto y Descripción	Detalles	OEM		
	<b>VX12004</b> Soporte De Motor	Peso : 1,302 kg / 2.870 lb	24443128, 5684101		
	<b>VX12005</b> Soporte De Motor	Peso : 1,403 kg / 3.093 lb	09156939, 5684086 9156939		
	<b>VX12006</b> Soporte De Motor	Peso : 2,070 kg / 4.564 lb Nota : HYDRAULIC	09156946, 5684089 9156946		
	<b>VX12007</b> Soporte De Motor	Peso : 1,434 kg / 3.161 lb Nota : HYDRAULIC	09156944, 5684088 9156944		
	<b>VX12020</b> Soporte De Motor	Peso : 1,360 kg / 2.998 lb	24443129, 5684102		
	<b>VX12021</b> Soporte De Motor	Posicion : Derecha Peso : 1,900 kg / 4.189 lb	13112022, 5684648		
	<b>VX12026</b> Soporte De Motor	Peso : 1,470 kg / 3.241 lb	13112029, 5684143		
	<b>VX12027</b> Soporte De Motor	Posicion : Derecha Peso : 1,350 kg / 2.976 lb	13183100, 5684765		
	<b>OP13005K</b> Cubre Polvo De Direccion	Peso : 0.106 kg / 0.234 lb	1609132, 77363710		

<b>TIGRA</b>		<b>95</b>		<b>1994 - 2000</b>	
Imagen	Clave del Producto y Descripción	Detalles	OEM		
	<b>OP13006K</b> Cubre Polvo De Direccion	Peso : 0.098 kg / 0.216 lb	1609121		

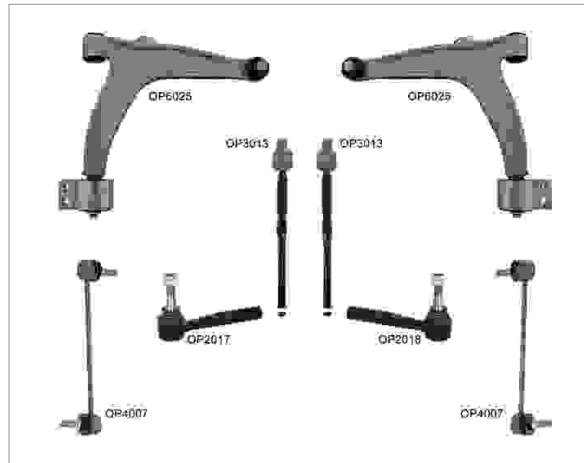
\* Nombres de los vehiculos, marcas, modelos, simbolos y logos, numero OE y otros numeros de terceros en el sitio web y catalogo solo son con fines de referencia.

**VECTRA**
**A**
**1988 - 1995**

Imagen	Clave del Producto y Descripción	Detalles	OEM
	<b>VX12001</b> Soporte De Motor	Chasis (Delantero / Trasero) : Delantero Posicion : Izquierdo Peso : 0,590 kg / 1.301 lb	684643, 90372699
	<b>VX12002</b> Soporte De Motor	Chasis (Delantero / Trasero) : Delantero Posicion : Derecha Peso : 0,610 kg / 1.345 lb	684644, 90335498

**OP8002 / Kit De Suspension Y Direccion**

**VECTRA**

**C**

**2002 - 2008**

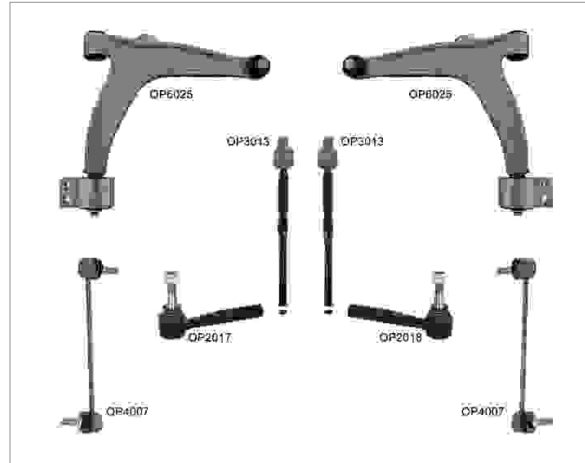

**Piezas del Kit**

Imagen	RIW Codigo / Nombre	OEM	OEM	RIW Codigo / Nombre	Imagen
	<b>OP2017</b> Terminal Exterior Frontal Derecho	1603228, 5235668 5239322, 77363712	12801423, 1603227 5235650, 5239314 77363713	<b>OP2018</b> Terminal Exterior Frontal Izquierdo	
	<b>OP3013</b> Terminal Interior Delantero	1603229, 1603351 1603415, 93172256	24417251, 350603 51741130	<b>OP4007</b> Tornillo Estabilizador Delantero	
	<b>OP6025</b> Horquillas Frontal Derecho Inferior	12796014, 12799200 352052, 51748652	12796013, 12799199 12799200, 352051 51748653	<b>OP6026</b> Horquillas Frontal Inferior Izquierdo	

\* Nombres de los vehiculos, marcas, modelos, simbolos y logos, numero OE y otros numeros de terceros en el sitio web y catalogo solo son con fines de referencia.

**VECTRA**
**C**
**2002 - 2008**

Imagen	Clave del Producto y Descripción	Detalles	OEM
	<b>VX12004</b> Soporte De Motor	Peso : 1,302 kg / 2.870 lb	24443128, 5684101
	<b>VX12005</b> Soporte De Motor	Peso : 1,403 kg / 3.093 lb	09156939, 5684086 9156939
	<b>VX12006</b> Soporte De Motor	Peso : 2,070 kg / 4.564 lb Nota : HYDRAULIC	09156946, 5684089 9156946
	<b>VX12007</b> Soporte De Motor	Peso : 1,434 kg / 3.161 lb Nota : HYDRAULIC	09156944, 5684088 9156944
	<b>VX12020</b> Soporte De Motor	Peso : 1,360 kg / 2.998 lb	24443129, 5684102
	<b>VX12021</b> Soporte De Motor	Posicion : Derecha Peso : 1,900 kg / 4.189 lb	13112022, 5684648
	<b>VX12026</b> Soporte De Motor	Peso : 1,470 kg / 3.241 lb	13112029, 5684143
	<b>VX12027</b> Soporte De Motor	Posicion : Derecha Peso : 1,350 kg / 2.976 lb	13183100, 5684765
	<b>OP13005K</b> Cubre Polvo De Direccion	Peso : 0.106 kg / 0.234 lb	1609132, 77363710

**VIVARO**
**I, II**
**2001 - 2014**

Imagen	Clave del Producto y Descripción	Detalles	OEM
	<b>RN12167K</b> Goma De Barra Estabilizadora	Posicion : Izquierda Y Derecha Peso : 0.15 kg / 0.331 lb Nota : 2 Piezas	4408905, 4417971 4418991, 4418992 8200048177, 8200629180 8200845492, 91166695 93861802, 93861803

\* Nombres de los vehículos, marcas, modelos, símbolos y logos, número OE y otros números de terceros en el sitio web y catálogo solo son con fines de referencia.

**VIVARO I, II 2001 - 2014**

Imagen	Clave del Producto y Descripción	Detalles	OEM
	<b>RN13011K</b> Cubre Polvo De Direccion	Peso : 0.16 kg / 0.353 lb	7701472765, 7701473334

**VIVARO III 2014 - 2018**

Imagen	Clave del Producto y Descripción	Detalles	OEM
	<b>RN12167K</b> Goma De Barra Estabilizadora	Posicion : Izquierda Y Derecha Peso : 0.15 kg / 0.331 lb Nota : 2 Pieces	4408905, 4417971 4418991, 4418992 8200048177, 8200629180 8200845492, 91166695 93861802, 93861803
	<b>RN13011K</b> Cubre Polvo De Direccion	Peso : 0.16 kg / 0.353 lb	7701472765, 7701473334

**ZAFIRA A F75 1998 - 2004**

Imagen	Clave del Producto y Descripción	Detalles	OEM
	<b>VX12031</b> Soporte De Motor	Chasis (Delantero / Trasero) : Delantero Peso : 0,881 kg / 1.942 lb	24459788, 24459817 684535, 90538549

**ZAFIRA B A05 2005 - 2011**

Imagen	Clave del Producto y Descripción	Detalles	OEM
	<b>OP11024K</b> Buje De Torsion	Posicion : Izquierda Y Derecha Peso : 0.784 kg / 1.728 lb Nota : 2 Pieces	13110418, 13267215 402952, 5402637
	<b>VX12018</b> Soporte De Motor	Peso : 0,950 kg / 2.094 lb	24459797, 5684136
	<b>VX12019</b> Soporte De Motor	Posicion : Derecha Peso : 0,916 kg / 2.019 lb	13221031, 24459816 5684187

**ZAFIRA**
**C P12**
**2011 -**

Imagen	Clave del Producto y Descripción	Detalles	OEM
	<b>VX12012</b> Soporte De Motor	Posicion : Derecha Peso : 2,120 kg / 4.674 lb	13347451, 684137 684321, 684435
	<b>VX12016</b> Soporte De Motor	Posicion : Derecha Peso : 1,655 kg / 3.649 lb	13248549, 682065
	<b>VX12025</b> Soporte De Motor	Peso : 0,850 kg / 1.874 lb	13248600, 684216
	<b>VX12030</b> Soporte De Motor	Chasis (Delantero / Trasero) : Delantero Peso : 0,800 kg / 1.764 lb	13248575, 684214
	<b>VX12036</b> Soporte De Motor	Chasis (Delantero / Trasero) : Delantero Peso : 2,062 kg / 4.546 lb Nota : HYDRAULIC	13248545, 682063







**RIW<sup>®</sup>**

**PEUGEOT**

**2008** | **2013 - 2019**

Imagen	Clave del Producto y Descripción	Detalles	OEM
	<b>PE3026</b> Terminal interior	Peso : 0,487 kg / 1.074 lb Longitud : 215,5 mm / 8.48 inch	1611158680
	<b>CI6029</b> Horquilla & Tijera	Peso : 3,408 kg / 7.513 lb Tipo de Material : Chapa Metálica	9803286480
	<b>CI6029J</b> Horquilla & Tijera	Peso : 2,874 kg / 6.336 lb Tipo de Material : Chapa Metálica	9803286480
	<b>CI6030</b> Horquilla & Tijera	Peso : 3,408 kg / 7.513 lb Tipo de Material : Chapa Metálica	9803286580
	<b>CI6030J</b> Horquilla & Tijera	Peso : 2,874 kg / 6.336 lb Tipo de Material : Chapa Metálica	9803286580

**208** | **2012 - 2019**

Imagen	Clave del Producto y Descripción	Detalles	OEM
	<b>CI6029</b> Horquilla & Tijera	Peso : 3,408 kg / 7.513 lb Tipo de Material : Chapa Metálica	9803286480
	<b>CI6029J</b> Horquilla & Tijera	Peso : 2,874 kg / 6.336 lb Tipo de Material : Chapa Metálica	9803286480
	<b>CI6030</b> Horquilla & Tijera	Peso : 3,408 kg / 7.513 lb Tipo de Material : Chapa Metálica	9803286580
	<b>CI6030J</b> Horquilla & Tijera	Peso : 2,874 kg / 6.336 lb Tipo de Material : Chapa Metálica	9803286580

**208 GTI****2012 - 2019**

Imagen	Clave del Producto y Descripción	Detalles	OEM
	<b>PE3026</b> Terminal interior	Peso : 0,487 kg / 1.074 lb Longitud : 215,5 mm / 8.48 inch	1611158680

**306****1993 - 2001**

Imagen	Clave del Producto y Descripción	Detalles	OEM
	<b>PE11018K</b> Buje De Horquilla & Tijera	Posicion : Izquierda Y Derecha Peso : 0,236 kg / 0.520 lb Nota : BEŞİK BURCU KİT	5131.47, 513147

**FI8006 / Kit De Suspensi?n Y Direccion**

**BIPPER**

**2008 - 2016**







**Piezas del Kit**

Imagen	RIW Codigo / Nombre	OEM	OEM	RIW Codigo / Nombre	Imagen
	<b>CI3012</b> Terminal Interior Delantero	1608899780, 1630726680 1630726780, 1630726880 1630726980, 1663659480 1663659680, 1663659780 4001.77, 4001.CW	3817.87, 381787 77364569	<b>FI2042</b> Terminal Exterior Frontal Derecho	
	<b>FI2043</b> Terminal Exterior Frontal Izquierdo	3817.86, 381786 77364568	5087.65, 5087.70 5087.79, 508765 508770, 51704008 51815479, 51815480	<b>FI4013</b> Tornillo Estabilizador Delantero	
	<b>FI6059</b> Horquillas Frontal Inferior Izquierdo	3520.W3, 3520.Y4 3520W3, 51783057 51839040, 51895367 5352039, 55703230 55703629	3521.S6, 3521.V5 50511650, 51783056 51839039, 51895366 5352038, 55703231 55703627	<b>FI6060</b> Horquillas Frontal Derecho Inferior	

\* Nombres de los vehiculos, marcas, modelos, simbolos y logos, numero OE y otros numeros de terceros en el sitio web y catalogo solo son con fines de referencia.

**BIPPER**
**2008 - 2016**

Imagen	Clave del Producto y Descripción	Detalles	OEM
	<b>FI12014A</b> Soporte De Amortiguador	Chasis (Delantero / Trasero) : Delantero Posicion : Derecha Otro Lado del Artículo : FI12015A Peso : 0.86 kg / 1.896 lb Nota : AMORTISÖR TAKOZU YENİ TİP	5038.G7, 5038.J8 51804748, 51839931 51855157, 52023099 52109286
	<b>FI12015A</b> Soporte De Amortiguador	Chasis (Delantero / Trasero) : Delantero Posicion : Izquierdo Otro Lado del Artículo : FI12014A Peso : 0.86 kg / 1.896 lb Nota : AMORTISÖR TAKOZU YENİ TİP	5038.G8, 5038.J7 51804747, 51839975 51855158, 51928747 52023097
	<b>FI12804</b> Soporte De Amortiguador	Chasis (Delantero / Trasero) : Delantero Posicion : Derecho-Izquierdo Peso : 1.68 kg / 3.704 lb Nota : KIT = FI12014 FI12015	5038.G7, 5038.G8 5038.J7, 5038.J8 51804747, 51804748 51839931, 51839975 51855157, 51855158
	<b>FI12804A</b> Soporte De Amortiguador	Chasis (Delantero / Trasero) : Delantero Posicion : Derecho-Izquierdo Peso : 1.68 kg / 3.704 lb Nota : KIT = FI12014A FI12015A	5038.G7, 5038.G8 5038.J7, 5038.J8 51804747, 51804748 51839931, 51839975 51855157, 51855158
	<b>FI13016K</b> Cubre Polvo De Direccion	Peso : 0.164 kg / 0.362 lb	4066.95, 77363828 77364571

**BOXER**
**1.1Q - 1.5Q - 1.7Q - 2.0Q**
**2006 -**

Imagen	Clave del Producto y Descripción	Detalles	OEM
	<b>FI12176</b> Soporte De Motor	Chasis (Delantero / Trasero) : Delantero Peso : 1,430 kg / 3.153 lb Tipo de Material : Soporte De Transmision	1344335080, 1854.25

**BOXER**
**IV**
**2015 -**

Imagen	Clave del Producto y Descripción	Detalles	OEM
	<b>CI6031</b> Horquilla & Tijera	Peso : 7,054 kg / 15.551 lb Tipo de Material : Döküm Çelik	1374222080, 1612735580
	<b>CI6032</b> Horquilla & Tijera	Peso : 7,054 kg / 15.551 lb Tipo de Material : Döküm Çelik	1374223080, 1612735680

**EXPERT III 2016 -**

Imagen	Clave del Producto y Descripción	Detalles	OEM
	<b>CI1008</b> Rotula	Peso : 0,365 kg / 0.805 lb Medida de Cono : Ø18,5 Diámetro de Cuerda del Perno : M14X1,5 Diámetro del Cuerpo de la Rotu : M40X1,5	9818657580
	<b>CI2016</b> Terminal Exterior	Peso : 0,809 kg / 1.784 lb Longitud : 185 mm / 7.28 inch	9820340180, SU001-A7208
	<b>CI2017</b> Terminal Exterior	Peso : 0,809 kg / 1.784 lb Longitud : 185 mm / 7.28 inch	9820340080, SU001-A7207

**PARTNER I 1996 - 2008**

Imagen	Clave del Producto y Descripción	Detalles	OEM
	<b>PE11018K</b> Buje De Horquilla & Tijera	Posicion : Izquierda Y Derecha Peso : 0,236 kg / 0.520 lb Nota : BEŞİK BURCU KIT	5131.47, 513147

**TRAVELLER 2016 -**

Imagen	Clave del Producto y Descripción	Detalles	OEM
	<b>CI1008</b> Rotula	Peso : 0,365 kg / 0.805 lb Medida de Cono : Ø18,5 Diámetro de Cuerda del Perno : M14X1,5 Diámetro del Cuerpo de la Rotu : M40X1,5	9818657580
	<b>CI2016</b> Terminal Exterior	Peso : 0,809 kg / 1.784 lb Longitud : 185 mm / 7.28 inch	9820340180, SU001-A7208
	<b>CI2017</b> Terminal Exterior	Peso : 0,809 kg / 1.784 lb Longitud : 185 mm / 7.28 inch	9820340080, SU001-A7207

**RIW<sup>®</sup>**

**PLYMOUTH**

**BARRACUDA I 1964 - 1966**

Imagen	Clave del Producto y Descripción	Detalles	OEM
	<b>CV4056</b> Tornillo Estabilizador	Peso : 0,182 kg / 0.401 lb Longitud : 195,5 mm / 7.70 inch	25784241

**BARRACUDA II 1967 - 1969**

Imagen	Clave del Producto y Descripción	Detalles	OEM
	<b>CV4056</b> Tornillo Estabilizador	Peso : 0,182 kg / 0.401 lb Longitud : 195,5 mm / 7.70 inch	25784241

**BARRACUDA III 1996 - 2000**

Imagen	Clave del Producto y Descripción	Detalles	OEM
	<b>CD4005</b> Tornillo Estabilizador	Peso : 0,220 kg / 0.485 lb Longitud : 145 mm / 5.71 inch	25679063, 3879218

**BELVEDERE I 1966 - 1967**

Imagen	Clave del Producto y Descripción	Detalles	OEM
	<b>CV4056</b> Tornillo Estabilizador	Peso : 0,182 kg / 0.401 lb Longitud : 195,5 mm / 7.70 inch	25784241

**BELVEDERE II 1968 - 1969**

Imagen	Clave del Producto y Descripción	Detalles	OEM
	<b>CV4056</b> Tornillo Estabilizador	Peso : 0,182 kg / 0.401 lb Longitud : 195,5 mm / 7.70 inch	25784241

**CUDA 1996 - 2000**

Imagen	Clave del Producto y Descripción	Detalles	OEM
	<b>CD4005</b> Tornillo Estabilizador	Peso : 0,220 kg / 0.485 lb Longitud : 145 mm / 5.71 inch	25679063, 3879218

\* Nombres de los vehículos, marcas, modelos, símbolos y logos, número OE y otros números de terceros en el sitio web y catálogo solo son con fines de referencia.



**GRAN FURY** | **1975 - 1977**

Imagen	Clave del Producto y Descripción	Detalles	OEM
	<b>CV4056</b> Tornillo Estabilizador	Peso : 0,182 kg / 0.401 lb Longitud : 195,5 mm / 7.70 inch	25784241

**ROADRUNNER** | **1968 - 1970**

Imagen	Clave del Producto y Descripción	Detalles	OEM
	<b>CV4056</b> Tornillo Estabilizador	Peso : 0,182 kg / 0.401 lb Longitud : 195,5 mm / 7.70 inch	25784241

**SAPORO** | **1978 - 1983**

Imagen	Clave del Producto y Descripción	Detalles	OEM
	<b>CD4005</b> Tornillo Estabilizador	Peso : 0,220 kg / 0.485 lb Longitud : 145 mm / 5.71 inch	25679063, 3879218

**SATELLITE** | **1966 - 1967**

Imagen	Clave del Producto y Descripción	Detalles	OEM
	<b>CV4056</b> Tornillo Estabilizador	Peso : 0,182 kg / 0.401 lb Longitud : 195,5 mm / 7.70 inch	25784241

**SATELLITE** | **1968 - 1969**

Imagen	Clave del Producto y Descripción	Detalles	OEM
	<b>CV4056</b> Tornillo Estabilizador	Peso : 0,182 kg / 0.401 lb Longitud : 195,5 mm / 7.70 inch	25784241

**VALIANT** | **1963 - 1966**

Imagen	Clave del Producto y Descripción	Detalles	OEM
	<b>CV4056</b> Tornillo Estabilizador	Peso : 0,182 kg / 0.401 lb Longitud : 195,5 mm / 7.70 inch	25784241

\* Nombres de los vehículos, marcas, modelos, símbolos y logos, número OE y otros números de terceros en el sitio web y catálogo solo son con fines de referencia.

**VALIANT III 1967 - 1973**

Imagen	Clave del Producto y Descripción	Detalles	OEM
	<b>CV4056</b> Tornillo Estabilizador	Peso : 0,182 kg / 0.401 lb Longitud : 195,5 mm / 7.70 inch	25784241

**VALIANT IV 1974 - 1976**

Imagen	Clave del Producto y Descripción	Detalles	OEM
	<b>CD4005</b> Tornillo Estabilizador	Peso : 0,220 kg / 0.485 lb Longitud : 145 mm / 5.71 inch	25679063, 3879218

\* Nombres de los vehículos, marcas, modelos, símbolos y logos, número OE y otros números de terceros en el sitio web y catálogo solo son con fines de referencia.

**RIW<sup>®</sup>**

**PONTIAC**

**BONNEVILLE IX 1992 - 1999**

Imagen	Clave del Producto y Descripción	Detalles	OEM
	<b>CD4005</b> Tornillo Estabilizador	Peso : 0,220 kg / 0.485 lb Longitud : 145 mm / 5.71 inch	25679063, 3879218

**BONNEVILLE V 1971 - 1976**

Imagen	Clave del Producto y Descripción	Detalles	OEM
	<b>CV1034</b> RÓTULA FRONTAL INFERIOR	Peso : 0,913 kg / 2.013 lb	7808865, 7814131 88965475, 9754378 9761498, 9766421
	<b>CD4004</b> Tornillo Estabilizador	Peso : 0,264 kg / 0.582 lb Longitud : 184 mm / 7.24 inch	10023178, 10164176 C1VY5A484A

**BONNEVILLE VI 1977 - 1981**

Imagen	Clave del Producto y Descripción	Detalles	OEM
	<b>CD4004</b> Tornillo Estabilizador	Peso : 0,264 kg / 0.582 lb Longitud : 184 mm / 7.24 inch	10023178, 10164176 C1VY5A484A

**BONNEVILLE VIII 1987 - 1991**

Imagen	Clave del Producto y Descripción	Detalles	OEM
	<b>CD4005</b> Tornillo Estabilizador	Peso : 0,220 kg / 0.485 lb Longitud : 145 mm / 5.71 inch	25679063, 3879218

**BONNEVILLE X 2000 - 2005**

Imagen	Clave del Producto y Descripción	Detalles	OEM
	<b>CV3030</b> Terminal interior	Peso : 0,647 kg / 1.426 lb Longitud : 324,5 mm / 12.78 inch	26003751, 26003759 26012282, 26021769
	<b>CD4005</b> Tornillo Estabilizador	Peso : 0,220 kg / 0.485 lb Longitud : 145 mm / 5.71 inch	25679063, 3879218

\* Nombres de los vehículos, marcas, modelos, símbolos y logos, número OE y otros números de terceros en el sitio web y catálogo solo son con fines de referencia.





**CATALINA IV 1971 - 1976**

Imagen	Clave del Producto y Descripción	Detalles	OEM
	<b>CV1034</b> RÓTULA FRONTAL INFERIOR	Peso : 0,913 kg / 2.013 lb	7808865, 7814131 88965475, 9754378 9761498, 9766421
	<b>CD4004</b> Tornillo Estabilizador	Peso : 0,264 kg / 0.582 lb Longitud : 184 mm / 7.24 inch	10023178, 10164176 C1VY5A484A

**CATALINA V 1977 - 1981**

Imagen	Clave del Producto y Descripción	Detalles	OEM
	<b>CD4004</b> Tornillo Estabilizador	Peso : 0,264 kg / 0.582 lb Longitud : 184 mm / 7.24 inch	10023178, 10164176 C1VY5A484A

**FIERO 1984 - 1988**

Imagen	Clave del Producto y Descripción	Detalles	OEM
	<b>CV4056</b> Tornillo Estabilizador	Peso : 0,182 kg / 0.401 lb Longitud : 195,5 mm / 7.70 inch	25784241
	<b>CV11030</b> Buje De Horquilla & Tijera	Chasis (Delantero / Trasero) : Delantero Peso : 0.211 kg / 0.465 lb	360747, 366746 462233, 475305 8942132950
	<b>CV11031</b> Buje De Horquilla & Tijera	Chasis (Delantero / Trasero) : Delantero Peso : 0.2 kg / 0.441 lb	360747, 366746 462233, 475305 8942132950
	<b>CV11802</b> Buje De Horquilla & Tijera	Chasis (Delantero / Trasero) : Delantero Peso : 0.5 kg / 1.102 lb Nota : KIT = CV11030 + CV11031	360747, 366746 462233, 475305 8942132950

**FIREBIRD II 1970 - 1981**

Imagen	Clave del Producto y Descripción	Detalles	OEM
	<b>CD4004</b> Tornillo Estabilizador	Peso : 0,264 kg / 0.582 lb Longitud : 184 mm / 7.24 inch	10023178, 10164176 C1VY5A484A

\* Nombres de los vehículos, marcas, modelos, símbolos y logos, número OE y otros números de terceros en el sitio web y catálogo solo son con fines de referencia.

**FIREBIRD**
**III**
**1982 - 1992**

Imagen	Clave del Producto y Descripción	Detalles	OEM
	<b>CD4004</b> Tornillo Estabilizador	Peso : 0,264 kg / 0.582 lb Longitud : 184 mm / 7.24 inch	10023178, 10164176 C1VY5A484A

**FIREBIRD**
**IV**
**1993 - 2002**

Imagen	Clave del Producto y Descripción	Detalles	OEM
	<b>CD4004</b> Tornillo Estabilizador	Peso : 0,264 kg / 0.582 lb Longitud : 184 mm / 7.24 inch	10023178, 10164176 C1VY5A484A

**G5**
**2007 - 2009**

Imagen	Clave del Producto y Descripción	Detalles	OEM
	<b>CV1027</b> Rotula	Peso : 0,656 kg / 1.446 lb	15240086, 15240089 15240092, 15240093 15803768, 15803769 19207818, 19207819 25984680, 25984681
	<b>CV6050</b> Horquilla & Tijera	Peso : 3,874 kg / 8.541 lb Tipo de Material : Chapa Metálica	15240086, 15240093 15803769, 19207818 25984681
	<b>CV6051</b> Horquilla & Tijera	Peso : 3,874 kg / 8.541 lb Tipo de Material : Chapa Metálica	15240089, 15240092 15803768, 19207819 25984680

**G6**
**2005 - 2010**

Imagen	Clave del Producto y Descripción	Detalles	OEM
	<b>CV3034</b> Terminal interior	Peso : 0,595 kg / 1.312 lb Longitud : 280 mm / 11.02 inch	15267582, 15944072 15944097, 19256420 20995477, 22687091
	<b>CV9004</b> Horquilla & Tijera	Peso : 2,078 kg / 4.581 lb Tipo de Material : Chapa Metálica	15292403
	<b>CV9005</b> Horquilla & Tijera	Peso : 2,078 kg / 4.581 lb Tipo de Material : Chapa Metálica	15292404

\* Nombres de los vehículos, marcas, modelos, símbolos y logos, número OE y otros números de terceros en el sitio web y catálogo solo son con fines de referencia.

**GRAND AM I 1973 - 1975**

Imagen	Clave del Producto y Descripción	Detalles	OEM
	<b>CD4004</b> Tornillo Estabilizador	Peso : 0,264 kg / 0.582 lb Longitud : 184 mm / 7.24 inch	10023178, 10164176 C1VY5A484A

**GRAND AM II 1978 - 1980**

Imagen	Clave del Producto y Descripción	Detalles	OEM
	<b>CD4004</b> Tornillo Estabilizador	Peso : 0,264 kg / 0.582 lb Longitud : 184 mm / 7.24 inch	10023178, 10164176 C1VY5A484A



**GRAND AM III 1985 - 1991**

Imagen	Clave del Producto y Descripción	Detalles	OEM
	<b>CD4004</b> Tornillo Estabilizador	Peso : 0,264 kg / 0.582 lb Longitud : 184 mm / 7.24 inch	10023178, 10164176 C1VY5A484A

**GRAND AM IV 1992 - 1998**

Imagen	Clave del Producto y Descripción	Detalles	OEM
	<b>CD4004</b> Tornillo Estabilizador	Peso : 0,264 kg / 0.582 lb Longitud : 184 mm / 7.24 inch	10023178, 10164176 C1VY5A484A

**GRAND AM V 1999 - 2005**

Imagen	Clave del Producto y Descripción	Detalles	OEM
	<b>CV1036</b> Rotula	Peso : 0,548 kg / 1.208 lb	10365842*, 22157023* 88967438*
	<b>CV4057</b> Tornillo Estabilizador	Peso : 0.188 kg / 0.414 lb Tipo de Material : Metal	22601062
	<b>CV4058</b> Tornillo Estabilizador	Peso : 0.188 kg / 0.414 lb Tipo de Material : Metal	22601060

\* Nombres de los vehículos, marcas, modelos, símbolos y logos, número OE y otros números de terceros en el sitio web y catálogo solo son con fines de referencia.

**GRAND PRIX II 1969 - 1972**

Imagen	Clave del Producto y Descripción	Detalles	OEM
	<b>CV4056</b> Tornillo Estabilizador	Peso : 0,182 kg / 0.401 lb Longitud : 195,5 mm / 7.70 inch	25784241

**GRAND PRIX III 1973 - 1977**

Imagen	Clave del Producto y Descripción	Detalles	OEM
	<b>CD4004</b> Tornillo Estabilizador	Peso : 0,264 kg / 0.582 lb Longitud : 184 mm / 7.24 inch	10023178, 10164176 C1VY5A484A

**GRAND PRIX V 1988 - 1993**

Imagen	Clave del Producto y Descripción	Detalles	OEM
	<b>CV3030</b> Terminal interior	Peso : 0,647 kg / 1.426 lb Longitud : 324,5 mm / 12.78 inch	26003751, 26003759 26012282, 26021769

**GRAND PRIX V FACELIFT 1994 - 1996**

Imagen	Clave del Producto y Descripción	Detalles	OEM
	<b>CV3030</b> Terminal interior	Peso : 0,647 kg / 1.426 lb Longitud : 324,5 mm / 12.78 inch	26003751, 26003759 26012282, 26021769

**GRAND PRIX VI 1997 - 2003**

Imagen	Clave del Producto y Descripción	Detalles	OEM
	<b>CV3030</b> Terminal interior	Peso : 0,647 kg / 1.426 lb Longitud : 324,5 mm / 12.78 inch	26003751, 26003759 26012282, 26021769

**GRAND PRIX VII 2004 - 2008**

Imagen	Clave del Producto y Descripción	Detalles	OEM
	<b>CV3030</b> Terminal interior	Peso : 0,647 kg / 1.426 lb Longitud : 324,5 mm / 12.78 inch	26003751, 26003759 26012282, 26021769

\* Nombres de los vehículos, marcas, modelos, símbolos y logos, número OE y otros números de terceros en el sitio web y catálogo solo son con fines de referencia.



**GRAND SAFARI**
**1971 - 1976**

Imagen	Clave del Producto y Descripción	Detalles	OEM
	<b>CV1034</b> RÓTULA FRONTAL INFERIOR	Peso : 0,913 kg / 2.013 lb	7808865, 7814131 88965475, 9754378 9761498, 9766421
	<b>CD4004</b> Tornillo Estabilizador	Peso : 0,264 kg / 0.582 lb Longitud : 184 mm / 7.24 inch	10023178, 10164176 C1VY5A484A

**GRAND SAFARI**
**1977 - 1978**

Imagen	Clave del Producto y Descripción	Detalles	OEM
	<b>CD4004</b> Tornillo Estabilizador	Peso : 0,264 kg / 0.582 lb Longitud : 184 mm / 7.24 inch	10023178, 10164176 C1VY5A484A

**GRANDVILLE**
**1970 - 1975**

Imagen	Clave del Producto y Descripción	Detalles	OEM
	<b>CV1034</b> RÓTULA FRONTAL INFERIOR	Peso : 0,913 kg / 2.013 lb	7808865, 7814131 88965475, 9754378 9761498, 9766421
	<b>CD4004</b> Tornillo Estabilizador	Peso : 0,264 kg / 0.582 lb Longitud : 184 mm / 7.24 inch	10023178, 10164176 C1VY5A484A

**GTO**
**I**
**1964 - 1967**

Imagen	Clave del Producto y Descripción	Detalles	OEM
	<b>CV4056</b> Tornillo Estabilizador	Peso : 0,182 kg / 0.401 lb Longitud : 195,5 mm / 7.70 inch	25784241

**GTO**
**II**
**1968 - 1972**

Imagen	Clave del Producto y Descripción	Detalles	OEM
	<b>CV4056</b> Tornillo Estabilizador	Peso : 0,182 kg / 0.401 lb Longitud : 195,5 mm / 7.70 inch	25784241

\* Nombres de los vehículos, marcas, modelos, símbolos y logos, número OE y otros números de terceros en el sitio web y catálogo solo son con fines de referencia.

**J2000**
**1982 - 1985**

Imagen	Clave del Producto y Descripción	Detalles	OEM
	<b>CD4004</b> Tornillo Estabilizador	Peso : 0,264 kg / 0.582 lb Longitud : 184 mm / 7.24 inch	10023178, 10164176 C1VY5A484A

**PARISIENNE**
**1977 - 1986**

Imagen	Clave del Producto y Descripción	Detalles	OEM
	<b>CD4004</b> Tornillo Estabilizador	Peso : 0,264 kg / 0.582 lb Longitud : 184 mm / 7.24 inch	10023178, 10164176 C1VY5A484A

**PARISIENNE**
**VI**
**1971 - 1976**

Imagen	Clave del Producto y Descripción	Detalles	OEM
	<b>CV1034</b> RÓTULA FRONTAL INFERIOR	Peso : 0,913 kg / 2.013 lb	7808865, 7814131 88965475, 9754378 9761498, 9766421

**PHOENIX**
**1977 - 1979**

Imagen	Clave del Producto y Descripción	Detalles	OEM
	<b>CD4004</b> Tornillo Estabilizador	Peso : 0,264 kg / 0.582 lb Longitud : 184 mm / 7.24 inch	10023178, 10164176 C1VY5A484A

**PURSUIT**
**2005 - 2006**

Imagen	Clave del Producto y Descripción	Detalles	OEM
	<b>CV1027</b> Rotula	Peso : 0,656 kg / 1.446 lb	15240086, 15240089 15240092, 15240093 15803768, 15803769 19207818, 19207819 25984680, 25984681
	<b>CV6050</b> Horquilla & Tijera	Peso : 3.874 kg / 8.541 lb Tipo de Material : Chapa Metálica	15240086, 15240093 15803769, 19207818 25984681
	<b>CV6051</b> Horquilla & Tijera	Peso : 3.874 kg / 8.541 lb Tipo de Material : Chapa Metálica	15240089, 15240092 15803768, 19207819 25984680

\* Nombres de los vehículos, marcas, modelos, símbolos y logos, número OE y otros números de terceros en el sitio web y catálogo solo son con fines de referencia.

**SOLSTICE**
**2006 - 2010**

Imagen	Clave del Producto y Descripción	Detalles	OEM
	<b>CD4008</b> Tornillo Estabilizador	Peso : 0,309 kg / 0.681 lb Tipo de Material : Metal Longitud : 82 mm / 3.23 inch	15840472, 15895320 25768312
	<b>CD4009</b> Tornillo Estabilizador	Peso : 0,309 kg / 0.681 lb Tipo de Material : Metal Longitud : 82 mm / 3.23 inch	15840471, 15895319 25768311

**SUNBIRD**
**1976 - 1988**

Imagen	Clave del Producto y Descripción	Detalles	OEM
	<b>CD4004</b> Tornillo Estabilizador	Peso : 0,264 kg / 0.582 lb Longitud : 184 mm / 7.24 inch	10023178, 10164176 C1VY5A484A

**SUNBIRD**
**1989 - 1994**

Imagen	Clave del Producto y Descripción	Detalles	OEM
	<b>CD4004</b> Tornillo Estabilizador	Peso : 0,264 kg / 0.582 lb Longitud : 184 mm / 7.24 inch	10023178, 10164176 C1VY5A484A

**T1000**
**1981 - 1987**

Imagen	Clave del Producto y Descripción	Detalles	OEM
	<b>CV11030</b> Buje De Horquilla & Tijera	Chasis (Delantero / Trasero) : Delantero Peso : 0.211 kg / 0.465 lb	360747, 366746 462233, 475305 8942132950
	<b>CV11031</b> Buje De Horquilla & Tijera	Chasis (Delantero / Trasero) : Delantero Peso : 0.2 kg / 0.441 lb	360747, 366746 462233, 475305 8942132950
	<b>CV11802</b> Buje De Horquilla & Tijera	Chasis (Delantero / Trasero) : Delantero Peso : 0.5 kg / 1.102 lb Nota : KIT = CV11030 + CV11031	360747, 366746 462233, 475305 8942132950

**TEMPEST**
**1964 - 1970**

Imagen	Clave del Producto y Descripción	Detalles	OEM
	<b>CV4056</b> Tornillo Estabilizador	Peso : 0,182 kg / 0.401 lb Longitud : 195,5 mm / 7.70 inch	25784241

**TEMPEST**
**1987 - 1991**

Imagen	Clave del Producto y Descripción	Detalles	OEM
	<b>CD4004</b> Tornillo Estabilizador	Peso : 0,264 kg / 0.582 lb Longitud : 184 mm / 7.24 inch	10023178, 10164176 C1VY5A484A

**VENTURA**
**1971 - 1977**

Imagen	Clave del Producto y Descripción	Detalles	OEM
	<b>CD4004</b> Tornillo Estabilizador	Peso : 0,264 kg / 0.582 lb Longitud : 184 mm / 7.24 inch	10023178, 10164176 C1VY5A484A





**VIBE**
**2003 - 2008**

Imagen	Clave del Producto y Descripción	Detalles	OEM
	<b>TO6103</b> Horquilla & Tijera	Peso : 4,101 kg / 9.041 lb Tipo de Material : Chapa Metálica	19205303, 4806813010 4806820390, 88970142
	<b>TO6104</b> Horquilla & Tijera	Peso : 4,101 kg / 9.041 lb Tipo de Material : Chapa Metálica	19205304, 4806913010 4806920390, 88970143

**RIW®**

**PORSCHE**

**911 991 2012 - 2019**

Imagen	Clave del Producto y Descripción	Detalles	OEM
	<b>PO3006</b> Terminal interior	Peso : 0,511 kg / 1.127 lb Longitud : 226,5 mm / 8.92 inch	99134732200
	<b>PO4013</b> Tornillo Estabilizador	Peso : 0,436 kg / 0.961 lb Tipo de Material : Metal Longitud : 260 mm / 10.24 inch	99134307002
	<b>PO4014</b> Tornillo Estabilizador	Peso : 0,436 kg / 0.961 lb Tipo de Material : Metal Longitud : 260 mm / 10.24 inch	99134306902
	<b>PO4016</b> Tornillo Estabilizador	Peso : 0,384 kg / 0.847 lb Tipo de Material : Metal Longitud : 234 mm / 9.21 inch	99133307102

**911 996 1997 - 2005**

Imagen	Clave del Producto y Descripción	Detalles	OEM
	<b>PO1001</b> Rotula	Peso : 0,350 kg / 0.772 lb Medida de Cono : Ø16,8 Diámetro de Cuerda del Perno : M12X1,5 Diámetro del Cuerpo de la Rotu : M38X1,5	99634100100
	<b>PO4015</b> Tornillo Estabilizador	Peso : 0,286 kg / 0.631 lb Tipo de Material : Metal Longitud : 285 mm / 11.22 inch Nota : FOR 4WD and TURBO	99634307303, 99634307304 99634307305
	<b>PO9001</b> Horquilla & Tijera	Peso : 0,600 kg / 1.323 lb Tipo de Material : Aluminio	99633104505, 99633104506 99633104507, 99633104508 99633104510, 99633104512 99733104504
	<b>PO9002</b> Horquilla & Tijera	Peso : 0,380 kg / 0.838 lb Tipo de Material : Aluminio	99633104702, 99633104703 99633104705, 99633104706 99733104700, 99733104701

**911 997 2004 - 2012**

Imagen	Clave del Producto y Descripción	Detalles	OEM
	<b>PO1001</b> Rotula	Peso : 0,350 kg / 0.772 lb Medida de Cono : Ø16,8 Diámetro de Cuerda del Perno : M12X1,5 Diámetro del Cuerpo de la Rotu : M38X1,5	99634100100

\* Nombres de los vehículos, marcas, modelos, símbolos y logos, número OE y otros números de terceros en el sitio web y catálogo solo son con fines de referencia.



**911 997 2004 - 2012**

Imagen	Clave del Producto y Descripción	Detalles	OEM
	<b>PO9001</b> Horquilla & Tijera	Peso : 0,600 kg / 1.323 lb Tipo de Material : Aluminio	99633104505, 99633104506 99633104507, 99633104508 99633104510, 99633104512 99733104504
	<b>PO9002</b> Horquilla & Tijera	Peso : 0,380 kg / 0.838 lb Tipo de Material : Aluminio	99633104702, 99633104703 99633104705, 99633104706 99733104700, 99733104701



**918 SYPDER 2013 -**

Imagen	Clave del Producto y Descripción	Detalles	OEM
	<b>PO3006</b> Terminal interior	Peso : 0,511 kg / 1.127 lb Longitud : 226,5 mm / 8.92 inch	99134732200

**BOXSTER 981 2013 - 2016**

Imagen	Clave del Producto y Descripción	Detalles	OEM
	<b>PO3006</b> Terminal interior	Peso : 0,511 kg / 1.127 lb Longitud : 226,5 mm / 8.92 inch	99134732200
	<b>PO4013</b> Tornillo Estabilizador	Peso : 0,436 kg / 0.961 lb Tipo de Material : Metal Longitud : 260 mm / 10.24 inch	99134307002
	<b>PO4014</b> Tornillo Estabilizador	Peso : 0,436 kg / 0.961 lb Tipo de Material : Metal Longitud : 260 mm / 10.24 inch	99134306902

**BOXSTER 986 1996 - 2004**

Imagen	Clave del Producto y Descripción	Detalles	OEM
	<b>PO1001</b> Rotula	Peso : 0,350 kg / 0.772 lb Medida de Cono : Ø16,8 Diámetro de Cuerda del Perno : M12X1,5 Diámetro del Cuerpo de la Rotu : M38X1,5	99634100100
	<b>PO9001</b> Horquilla & Tijera	Peso : 0,600 kg / 1.323 lb Tipo de Material : Aluminio	99633104505, 99633104506 99633104507, 99633104508 99633104510, 99633104512 99733104504

\* Nombres de los vehículos, marcas, modelos, símbolos y logos, número OE y otros números de terceros en el sitio web y catálogo solo son con fines de referencia.

**BOXSTER 986 1996 - 2004**

Imagen	Clave del Producto y Descripción	Detalles	OEM
	<b>PO9002</b> Horquilla & Tijera	Peso : 0,380 kg / 0.838 lb Tipo de Material : Aluminio	99633104702, 99633104703 99633104705, 99633104706 99733104700, 99733104701

**BOXSTER 987 2004 - 2012**

Imagen	Clave del Producto y Descripción	Detalles	OEM
	<b>PO1001</b> Rotula	Peso : 0,350 kg / 0.772 lb Medida de Cono : Ø16,8 Diámetro de Cuerda del Perno : M12X1,5 Diámetro del Cuerpo de la Rotu : M38X1,5	99634100100
	<b>PO9001</b> Horquilla & Tijera	Peso : 0,600 kg / 1.323 lb Tipo de Material : Aluminio	99633104505, 99633104506 99633104507, 99633104508 99633104510, 99633104512 99733104504
	<b>PO9002</b> Horquilla & Tijera	Peso : 0,380 kg / 0.838 lb Tipo de Material : Aluminio	99633104702, 99633104703 99633104705, 99633104706 99733104700, 99733104701

**BOXSTER 718 982 2016 -**



Imagen	Clave del Producto y Descripción	Detalles	OEM
	<b>PO3006</b> Terminal interior	Peso : 0,511 kg / 1.127 lb Longitud : 226,5 mm / 8.92 inch	99134732200

**CAYENNE 9PA 2002 - 2010**

Imagen	Clave del Producto y Descripción	Detalles	OEM
	<b>VW6067</b> Horquilla & Tijera	Peso : 8,834 kg / 19.476 lb Tipo de Material : Döküm Çelik	7L0407152F, 7L0407152J 7L0407152K, 95534101860 95534101861
	<b>VW6068</b> Horquilla & Tijera	Peso : 8,834 kg / 19.476 lb Tipo de Material : Döküm Çelik	7L0407151F, 7L0407151J 7L0407151K, 95534101760 95534101761



**CAYMAN 981 2014 - 2016**

Imagen	Clave del Producto y Descripción	Detalles	OEM
	<b>PO3006</b> Terminal interior	Peso : 0,511 kg / 1.127 lb Longitud : 226,5 mm / 8.92 inch	99134732200
	<b>PO4013</b> Tornillo Estabilizador	Peso : 0,436 kg / 0.961 lb Tipo de Material : Metal Longitud : 260 mm / 10.24 inch	99134307002
	<b>PO4014</b> Tornillo Estabilizador	Peso : 0,436 kg / 0.961 lb Tipo de Material : Metal Longitud : 260 mm / 10.24 inch	99134306902

**CAYMAN 987 2005 - 2013**

Imagen	Clave del Producto y Descripción	Detalles	OEM
	<b>PO1001</b> Rotula	Peso : 0,350 kg / 0.772 lb Medida de Cono : Ø16,8 Diámetro de Cuerda del Perno : M12X1,5 Diámetro del Cuerpo de la Rotu : M38X1,5	99634100100
	<b>PO9001</b> Horquilla & Tijera	Peso : 0,600 kg / 1.323 lb Tipo de Material : Aluminio	99633104505, 99633104506 99633104507, 99633104508 99633104510, 99633104512 99733104504
	<b>PO9002</b> Horquilla & Tijera	Peso : 0,380 kg / 0.838 lb Tipo de Material : Aluminio	99633104702, 99633104703 99633104705, 99633104706 99733104700, 99733104701

**CAYMAN 718 982 2016 -**

Imagen	Clave del Producto y Descripción	Detalles	OEM
	<b>PO3006</b> Terminal interior	Peso : 0,511 kg / 1.127 lb Longitud : 226,5 mm / 8.92 inch	99134732200

**MACAN 95B 2014 -**

Imagen	Clave del Producto y Descripción	Detalles	OEM
	<b>AU5073</b> Horquilla & Tijera	Peso : 2,330 kg / 5.137 lb Tipo de Material : Aluminio	8K0407694AD, 8K0407694Q 8K0407694S, 8R0407694B 8R0407694D, 9A740769403

\* Nombres de los vehículos, marcas, modelos, símbolos y logos, número OE y otros números de terceros en el sitio web y catálogo solo son con fines de referencia.

**MACAN****95B****2014 -**

Imagen	Clave del Producto y Descripción	Detalles	OEM
	<b>AU5074</b> Horquilla & Tijera	Peso : 2,330 kg / 5.137 lb Tipo de Material : Aluminio	8K0407693AD, 8K0407693Q 8K0407693S, 8R0407693B 8R0407693D, 9A740769303

**RIW<sup>®</sup>**

**RAM**

**1500**
**2010 - 2012**

Imagen	Clave del Producto y Descripción	Detalles	OEM
	<b>DO1007</b> Rotula	Peso : 0,506 kg / 1.116 lb Medida de Cono : Ø16,7 Diámetro de Cuerda del Perno : M14X1,5 Diámetro del Cuerpo de la Rotu : Ø46,5	5174041AC
	<b>DO4012</b> Tornillo Estabilizador	Peso : 0,516 kg / 1.138 lb Longitud : 108,1 mm / 4.26 inch Nota : 2WD	05072934AE, 5072934AD 5072934AE, 5086972AB
	<b>DO4014</b> Tornillo Estabilizador	Peso : 0,546 kg / 1.204 lb Longitud : 160,9 mm / 6.33 inch Nota : 4WD	5170290AB, 5170290AC 5170290AD

**1500**
**2013 - 2018**

Imagen	Clave del Producto y Descripción	Detalles	OEM
	<b>DO1007</b> Rotula	Peso : 0,506 kg / 1.116 lb Medida de Cono : Ø16,7 Diámetro de Cuerda del Perno : M14X1,5 Diámetro del Cuerpo de la Rotu : Ø46,5	5174041AC
	<b>DO4014</b> Tornillo Estabilizador	Peso : 0,546 kg / 1.204 lb Longitud : 160,9 mm / 6.33 inch Nota : 4WD	5170290AB, 5170290AC 5170290AD

**2500**
**2011 - 2013**

Imagen	Clave del Producto y Descripción	Detalles	OEM
	<b>DO1007</b> Rotula	Peso : 0,506 kg / 1.116 lb Medida de Cono : Ø16,7 Diámetro de Cuerda del Perno : M14X1,5 Diámetro del Cuerpo de la Rotu : Ø46,5	5174041AC
	<b>DO4012</b> Tornillo Estabilizador	Peso : 0,516 kg / 1.138 lb Longitud : 108,1 mm / 4.26 inch Nota : 2WD	05072934AE, 5072934AD 5072934AE, 5086972AB

**3500**
**2011 - 2013**

Imagen	Clave del Producto y Descripción	Detalles	OEM
	<b>DO1007</b> Rotula	Peso : 0,506 kg / 1.116 lb Medida de Cono : Ø16,7 Diámetro de Cuerda del Perno : M14X1,5 Diámetro del Cuerpo de la Rotu : Ø46,5	5174041AC

\* Nombres de los vehículos, marcas, modelos, símbolos y logos, número OE y otros números de terceros en el sitio web y catálogo solo son con fines de referencia.

**3500****2011 - 2013**

Imagen	Clave del Producto y Descripción	Detalles	OEM
	<b>DO4012</b> Tornillo Estabilizador	Peso : 0,516 kg / 1.138 lb Longitud : 108,1 mm / 4.26 inch Nota : 2WD	05072934AE, 5072934AD 5072934AE, 5086972AB

**RIW<sup>®</sup>**

**RENAULT**

**19**
**1991 - 2001**

Imagen	Clave del Producto y Descripción	Detalles	OEM
	<b>RN11011K</b> Buje De Horquilla & Tijera	Posicion : Izquierda Y Derecha Peso : 0,330 kg / 0.728 lb	7700789477
	<b>RN13004K</b> Cubre Polvo De Direccion	Peso : 0.17 kg / 0.375 lb	7700678649, 7700678697

**21**
**MANAGER**
**1986 - 1994**

Imagen	Clave del Producto y Descripción	Detalles	OEM
	<b>RN12181</b> SOPORTE FRONTAL DERECHO	Chasis (Delantero / Trasero) : Delantero Posicion : Derecha Otro Lado del Artículo : RN12182 Peso : 0.66 kg / 1.455 lb	7700769720
	<b>RN12182</b> SOPORTE FRONTAL IZQUIERDO	Chasis (Delantero / Trasero) : Delantero Posicion : Izquierdo Otro Lado del Artículo : RN12181 Peso : 0.66 kg / 1.455 lb	7700769719
	<b>RN13004K</b> Cubre Polvo De Direccion	Peso : 0.17 kg / 0.375 lb	7700678649, 7700678697

**9, 11**
**1981 - 2000**

Imagen	Clave del Producto y Descripción	Detalles	OEM
	<b>RN13004K</b> Cubre Polvo De Direccion	Peso : 0.17 kg / 0.375 lb	7700678649, 7700678697

**ALASKAN**
**2017 -**

Imagen	Clave del Producto y Descripción	Detalles	OEM
	<b>ME1029</b> Rotula	Peso : 0,668 kg / 1.473 lb Diámetro del Cuerpo de la Rotu : Ø43,3	4703300700*, 4703301000* 54500-5XA0A*, 54501-5XA0A* A4703300700*, A4703301000*
	<b>ME4107</b> Tornillo Estabilizador	Peso : 0,383 kg / 0.844 lb Tipo de Material : Metal Longitud : 70 mm / 2.76 inch	4703202300, 54618-4KH0A 54618-5XA0A, A4703202300

\* Nombres de los vehículos, marcas, modelos, símbolos y logos, número OE y otros números de terceros en el sitio web y catálogo solo son con fines de referencia.

**ALASKAN**
**2017 -**

Imagen	Clave del Producto y Descripción	Detalles	OEM
	<b>ME4108</b> Tornillo Estabilizador	Peso : 0,383 kg / 0.844 lb Tipo de Material : Metal Longitud : 70 mm / 2.76 inch	4703202200, 54668-4KH0A 54668-5XA0A, A4703202200
	<b>ME4109</b> Tornillo Estabilizador	Peso : 0,508 kg / 1.120 lb Tipo de Material : Metal Longitud : 210 mm / 8.27 inch Nota : Metal	4703260100, 562614KH0A 562615XA0A

**AVANTIME**
**2001 - 2003**

Imagen	Clave del Producto y Descripción	Detalles	OEM
	<b>RN13022K</b> Cubre Polvo De Direccion	Peso : 0.152 kg / 0.335 lb	4501260, 6001547607 6025 370 231, 6025370231 9161560

**CLIO**
**I**
**1990 - 1998**

Imagen	Clave del Producto y Descripción	Detalles	OEM
	<b>RN13004K</b> Cubre Polvo De Direccion	Peso : 0.17 kg / 0.375 lb	7700678649, 7700678697

**SPACE**
**III**
**1996 - 2002**

Imagen	Clave del Producto y Descripción	Detalles	OEM
	<b>RN13022K</b> Cubre Polvo De Direccion	Peso : 0.152 kg / 0.335 lb	4501260, 6001547607 6025 370 231, 6025370231 9161560

**EXPRESS**
**EXTRA VAN F40, G40**
**1985 - 1998**

Imagen	Clave del Producto y Descripción	Detalles	OEM
	<b>RN13004K</b> Cubre Polvo De Direccion	Peso : 0.17 kg / 0.375 lb	7700678649, 7700678697



**KOLEOS I 2008 - 2016**

Imagen	Clave del Producto y Descripción	Detalles	OEM
	<b>RN3024</b> Terminal interior	Peso : 0,521 kg / 1.149 lb Longitud : 238,3 mm / 9.38 inch Tamaño de la Rosca : M18X1,5 Diámetro de Cuerda del Perno : M14X1,5	485213026R
	<b>NS13006K</b> Cubre Polvo De Direccion	Peso : 0.1 kg / 0.220 lb	48203-JD01A

**LAGUNA II 2001 - 2007**

Imagen	Clave del Producto y Descripción	Detalles	OEM
	<b>RN13011K</b> Cubre Polvo De Direccion	Peso : 0.16 kg / 0.353 lb	7701472765, 7701473334

**LOGAN LS 2004 - 2012**

Imagen	Clave del Producto y Descripción	Detalles	OEM
	<b>RN13022K</b> Cubre Polvo De Direccion	Peso : 0.152 kg / 0.335 lb	4501260, 6001547607 6025 370 231, 6025370231 9161560

**LOGAN MCV KS 2007 - 2013**

Imagen	Clave del Producto y Descripción	Detalles	OEM
	<b>RN13022K</b> Cubre Polvo De Direccion	Peso : 0.152 kg / 0.335 lb	4501260, 6001547607 6025 370 231, 6025370231 9161560

**MASTER I FD, JD, ND 1998 - 2003**

Imagen	Clave del Producto y Descripción	Detalles	OEM
	<b>RN6013J</b> Horquilla & Tijera	Peso : 8,300 kg / 18.298 lb Tipo de Material : Döküm Çelik	4400048, 4404048 4500093, 5450000QAC 54500-00QAD, 5450000QAE 7700302119, 7700309190 8200767822, 8200767825
	<b>RN6014J</b> Horquilla & Tijera	Peso : 8,300 kg / 18.298 lb Tipo de Material : Döküm Çelik	4400048, 4404048 4500093, 5450000QAC 54500-00QAD, 5450000QAE 7700302119, 7700309190 8200767822, 8200767825

\* Nombres de los vehículos, marcas, modelos, símbolos y logos, número OE y otros números de terceros en el sitio web y catálogo solo son con fines de referencia.

**MASTER I FD, JD, ND 1998 - 2003**

Imagen	Clave del Producto y Descripción	Detalles	OEM
	<b>RN12183</b> Buje De Torsion	Chasis (Delantero / Trasero) : Trasera Posicion : Izquierda Y Derecha Peso : 0,200 kg / 0.441 lb Tipo de Material : Rubber	5000392657
	<b>RN13022K</b> Cubre Polvo De Direccion	Peso : 0.152 kg / 0.335 lb	4501260, 6001547607 6025 370 231, 6025370231 9161560

**MASTER II HD, FD 2003 - 2010**

Imagen	Clave del Producto y Descripción	Detalles	OEM
	<b>RN12183</b> Buje De Torsion	Chasis (Delantero / Trasero) : Trasera Posicion : Izquierda Y Derecha Peso : 0,200 kg / 0.441 lb Tipo de Material : Rubber	5000392657

**MASTER III 2010 -**

Imagen	Clave del Producto y Descripción	Detalles	OEM
	<b>RN13023</b> Cubre Polvo De Direccion	Peso : 0.14 kg / 0.309 lb Diametro Grande : 94 Diametro Pequeño : 75	4419289, 4422830 543880453R, 93197323 95517236

**MEGANE I 1995 - 2003**

Imagen	Clave del Producto y Descripción	Detalles	OEM
	<b>RN11011K</b> Buje De Horquilla & Tijera	Posicion : Izquierda Y Derecha Peso : 0,330 kg / 0.728 lb	7700789477

**RN8001 / Kit De Suspension Y Direccion**



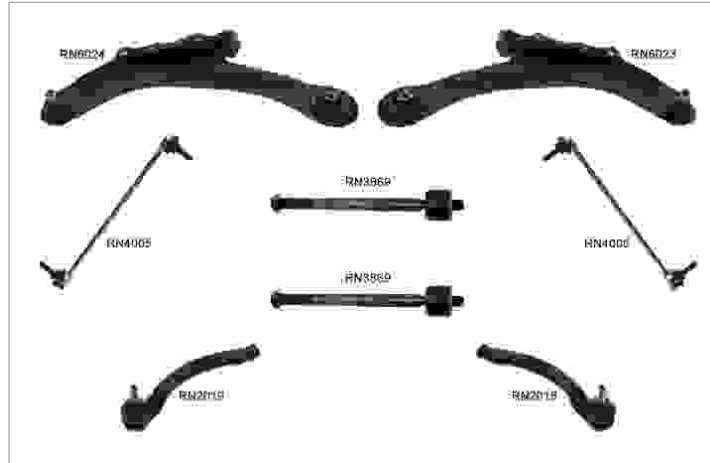

**MEGANE**

**II**

**2003 - 2009**



**Piezas del Kit**

Imagen	RIWCodigo / Nombre	OEM	OEM	RIWCodigo / Nombre	Imagen
	<b>RN2018</b> Terminal Exterior Frontal Derecho	7701474796	7701474795	<b>RN2019</b> Terminal Exterior Frontal Izquierdo	
	<b>RN3869</b> Terminal Interior Delantero	7701474448	4153200000, 4153200189 8200166159, 8200669065 8660005542, A4153200000 A4153200189	<b>RN4005</b> Tornillo Estabilizador Delantero	
	<b>RN6023</b> Horquillas Frontal Derecho Inferior	545003037R, 545040131R 545041327R, 545045476R 545045743R, 545047954R 8200298455, 8200457209 8200679067	545017775R, 545052737R 545053170R, 545055208R 545055708R, 545059335R 8200298454, 8200679063	<b>RN6024</b> Horquillas Frontal Inferior Izquierdo	

\* Nombres de los vehiculos, marcas, modelos, simbolos y logos, numero OE y otros numeros de terceros en el sitio web y catalogo solo son con fines de referencia.

**MEGANE II 2003 - 2009**

Imagen	Clave del Producto y Descripción	Detalles	OEM
	<b>RN13003K</b> Cubre Polvo De Direccion	Peso : 0.012 kg / 0.026 lb	7701474447

**SCENIC I 1997 - 2002**

Imagen	Clave del Producto y Descripción	Detalles	OEM
	<b>RN3023</b> Terminal interior	Peso : 0,527 kg / 1.162 lb Longitud : 328,2 mm / 12.92 inch	7701473443
	<b>RN11011K</b> Buje De Horquilla & Tijera	Posicion : Izquierda Y Derecha Peso : 0,330 kg / 0.728 lb	7700789477

**RN8001 / Kit De Suspension Y Direccion**





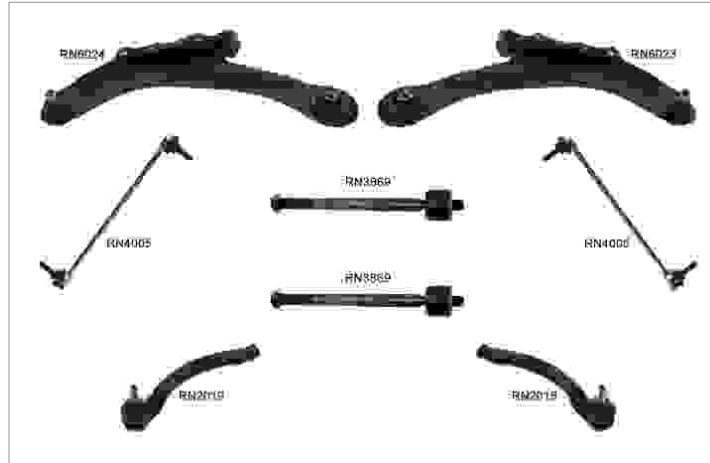

**SCENIC**

**II**

**2003 - 2009**



**Piezas del Kit**

Imagen	RIW Codigo / Nombre	OEM	OEM	RIW Codigo / Nombre	Imagen
	<b>RN2018</b> Terminal Exterior Frontal Derecho	7701474796	7701474795	<b>RN2019</b> Terminal Exterior Frontal Izquierdo	
	<b>RN3869</b> Terminal Interior Delantero	7701474448	4153200000, 4153200189 8200166159, 8200669065 8660005542, A4153200000 A4153200189	<b>RN4005</b> Tornillo Estabilizador Delantero	
	<b>RN6023</b> Horquillas Frontal Derecho Inferior	545003037R, 545040131R 545041327R, 545045476R 545045743R, 545047954R 8200298455, 8200457209 8200679067	545017775R, 545052737R 545053170R, 545055208R 545055708R, 545059335R 8200298454, 8200679063	<b>RN6024</b> Horquillas Frontal Inferior Izquierdo	

\* Nombres de los vehiculos, marcas, modelos, simbolos y logos, numero OE y otros numeros de terceros en el sitio web y catalogo solo son con fines de referencia.

**SCENIC II 2003 - 2009**

Imagen	Clave del Producto y Descripción	Detalles	OEM
	<b>RN13003K</b> Cubre Polvo De Direccion	Peso : 0.012 kg / 0.026 lb	7701474447

**TRAFIC II 2001 - 2014**

Imagen	Clave del Producto y Descripción	Detalles	OEM
	<b>RN12167K</b> Goma De Barra Estabilizadora	Posicion : Izquierda Y Derecha Peso : 0.15 kg / 0.331 lb Nota : 2 Pieces	4408905, 4417971 4418991, 4418992 8200048177, 8200629180 8200845492, 91166695 93861802, 93861803
	<b>RN13011K</b> Cubre Polvo De Direccion	Peso : 0.16 kg / 0.353 lb	7701472765, 7701473334

**TRAFIC III 2014 -**

Imagen	Clave del Producto y Descripción	Detalles	OEM
	<b>RN12167K</b> Goma De Barra Estabilizadora	Posicion : Izquierda Y Derecha Peso : 0.15 kg / 0.331 lb Nota : 2 Pieces	4408905, 4417971 4418991, 4418992 8200048177, 8200629180 8200845492, 91166695 93861802, 93861803
	<b>RN13011K</b> Cubre Polvo De Direccion	Peso : 0.16 kg / 0.353 lb	7701472765, 7701473334

**TWINGO I C06 1993 - 2007**







Imagen	Clave del Producto y Descripción	Detalles	OEM
	<b>RN13004K</b> Cubre Polvo De Direccion	Peso : 0.17 kg / 0.375 lb	7700678649, 7700678697

**TWINGO III BCM 2014 -**

Imagen	Clave del Producto y Descripción	Detalles	OEM
	<b>SM2003</b> Terminal Exterior	Peso : 0,358 kg / 0.789 lb Longitud : 90 mm / 3.54 inch	45333-07000

\* Nombres de los vehiculos, marcas, modelos, simbolos y logos, numero OE y otros numeros de terceros en el sitio web y catalogo solo son con fines de referencia.

**TWINGO**
**III BCM**
**2014 -**

Imagen	Clave del Producto y Descripción	Detalles	OEM
	<b>SM2004</b> Terminal Exterior	Peso : 0,358 kg / 0.789 lb Longitud : 90 mm / 3.54 inch	45333-07100
	<b>SM3003</b> Terminal interior	Peso : 0,654 kg / 1.442 lb Longitud : 392,5 mm / 15.45 inch	Part of 4534630000, Part of 485215653R
	<b>SM6007</b> Horquilla & Tijera	Peso : 2,235 kg / 4.927 lb Tipo de Material : Chapa Metálica	4533303000, 545047654R
	<b>SM6008</b> Horquilla & Tijera	Peso : 2,235 kg / 4.927 lb Tipo de Material : Chapa Metálica	4533302900, 545051097R
	<b>SM6009</b> Horquilla & Tijera	Peso : 2,731 kg / 6.021 lb Tipo de Material : Chapa Metálica	4533303200, 545048628R
	<b>SM6010</b> Horquilla & Tijera	Peso : 2,235 kg / 4.927 lb Tipo de Material : Chapa Metálica	4533303100, 545057345R

**RIW<sup>®</sup>**

**SAAB**



**OP8002 / Kit De Suspension Y Direccion**

**9-3**

**YS3F**

**2002 - 2009**

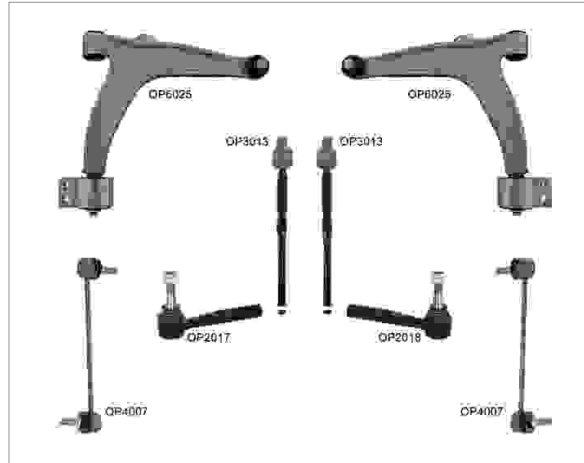

**Piezas del Kit**

Imagen	RIW Codigo / Nombre	OEM	OEM	RIW Codigo / Nombre	Imagen
	<b>OP2017</b> Terminal Exterior Frontal Derecho	1603228, 5235668 5239322, 77363712	12801423, 1603227 5235650, 5239314 77363713	<b>OP2018</b> Terminal Exterior Frontal Izquierdo	
	<b>OP3013</b> Terminal Interior Delantero	1603229, 1603351 1603415, 93172256	24417251, 350603 51741130	<b>OP4007</b> Tornillo Estabilizador Delantero	
	<b>OP6025</b> Horquillas Frontal Derecho Inferior	12796014, 12799200 352052, 51748652	12796013, 12799199 12799200, 352051 51748653	<b>OP6026</b> Horquillas Frontal Inferior Izquierdo	

\* Nombres de los vehiculos, marcas, modelos, simbolos y logas, numero OE y otros numeros de terceros en el sitio web y catalogo solo son con fines de referencia.

**9-3 YS3F 2002 - 2009**

Imagen	Clave del Producto y Descripción	Detalles	OEM
	<b>VX12005</b> Soporte De Motor	Peso : 1,403 kg / 3.093 lb	09156939, 5684086 9156939
	<b>VX12026</b> Soporte De Motor	Peso : 1,470 kg / 3.241 lb	13112029, 5684143
	<b>OP13005K</b> Cubre Polvo De Direccion	Peso : 0.106 kg / 0.234 lb	1609132, 77363710

**9-5 YS3G 2010 - 2012**

Imagen	Clave del Producto y Descripción	Detalles	OEM
	<b>VX12022</b> Soporte De Motor	Peso : 0,840 kg / 1.852 lb	13227762, 684612 684613, 91050354
	<b>VX12028</b> Soporte De Motor	Chasis (Delantero / Trasero) : Delantero Peso : 0,830 kg / 1.830 lb	13227769, 684616

**9-7X 2005 - 2009**

Imagen	Clave del Producto y Descripción	Detalles	OEM
	<b>CV3035</b> Terminal interior	Peso : 0,534 kg / 1.177 lb Longitud : 135 mm / 5.31 inch	26100288, 8261002880
	<b>CV4056</b> Tornillo Estabilizador	Peso : 0,182 kg / 0.401 lb Longitud : 195,5 mm / 7.70 inch	25784241

**RIW<sup>®</sup>**

**SATURN**

**AURA**
**2007 - 2009**

Imagen	Clave del Producto y Descripción	Detalles	OEM
	<b>CV3034</b> Terminal interior	Peso : 0,595 kg / 1.312 lb Longitud : 280 mm / 11.02 inch	15267582, 15944072 15944097, 19256420 20995477, 22687091
	<b>CV9004</b> Horquilla & Tijera	Peso : 2,078 kg / 4.581 lb Tipo de Material : Chapa Metálica	15292403
	<b>CV9005</b> Horquilla & Tijera	Peso : 2,078 kg / 4.581 lb Tipo de Material : Chapa Metálica	15292404

**ION**
**2005 - 2007**

Imagen	Clave del Producto y Descripción	Detalles	OEM
	<b>CV1027</b> Rotula	Peso : 0,656 kg / 1.446 lb	15240086, 15240089 15240092, 15240093 15803768, 15803769 19207818, 19207819 25984680, 25984681
	<b>CV6050</b> Horquilla & Tijera	Peso : 3,874 kg / 8.541 lb Tipo de Material : Chapa Metálica	15240086, 15240093 15803769, 19207818 25984681
	<b>CV6051</b> Horquilla & Tijera	Peso : 3,874 kg / 8.541 lb Tipo de Material : Chapa Metálica	15240089, 15240092 15803768, 19207819 25984680

**SKY**
**2007 - 2010**

Imagen	Clave del Producto y Descripción	Detalles	OEM
	<b>CD4008</b> Tornillo Estabilizador	Peso : 0,309 kg / 0.681 lb Tipo de Material : Metal Longitud : 82 mm / 3.23 inch	15840472, 15895320 25768312
	<b>CD4009</b> Tornillo Estabilizador	Peso : 0,309 kg / 0.681 lb Tipo de Material : Metal Longitud : 82 mm / 3.23 inch	15840471, 15895319 25768311

**VUE****2002 - 2007**

Imagen	Clave del Producto y Descripción	Detalles	OEM
	<b>CV4054</b> Tornillo Estabilizador	Peso : 0,191 kg / 0.421 lb Longitud : 69.6 mm / 2.74 inch	15791211, 22692175

**RIW<sup>®</sup>**

**SCION**

**FR-S**
**2012 - 2016**

Imagen	Clave del Producto y Descripción	Detalles	OEM
	<b>SU3011</b> Terminal interior	Peso : 0,476 kg / 1.049 lb Longitud : 226.5 mm / 8.92 inch	34160CA000, SU00300832

**TC**
**AGT20**
**2011 - 2016**

Imagen	Clave del Producto y Descripción	Detalles	OEM
	<b>TO9016</b> Horquilla & Tijera	Peso : 1,440 kg / 3.175 lb Tipo de Material : Chapa Metálica	4877012010

**TC**
**ANT10**
**2005 - 2010**

Imagen	Clave del Producto y Descripción	Detalles	OEM
	<b>TO1054</b> Rotula	Peso : 0,726 kg / 1.601 lb	43330-09670

**RIW<sup>®</sup>**

**SEAT**





**ALHAMBRA 7N 2010 - 2022**









Imagen	Clave del Producto y Descripción	Detalles	OEM
	<b>VW12159</b> Buje De Eje	Chasis (Delantero / Trasero) : Trasera Posicion : Izquierda Y Derecha Peso : 0,130 kg / 0.287 lb	1K0505553, 1K0505553A
	<b>AU12024</b> Buje De Torsion	Chasis (Delantero / Trasero) : Trasera Posicion : Izquierda Y Derecha Peso : 0.557 kg / 1.228 lb	1K0505145F, 1K0505145H 1K0505145K
	<b>VW13006K</b> Cubre Polvo De Direccion	Peso : 0.29 kg / 0.639 lb	1K0423831A, 5C0423831

**ALTEA V 5P1 2004 - 2009**

Imagen	Clave del Producto y Descripción	Detalles	OEM
	<b>VW12159</b> Buje De Eje	Chasis (Delantero / Trasero) : Trasera Posicion : Izquierda Y Derecha Peso : 0,130 kg / 0.287 lb	1K0505553, 1K0505553A
	<b>VW13006K</b> Cubre Polvo De Direccion	Peso : 0.29 kg / 0.639 lb	1K0423831A, 5C0423831

**ALTEA XL 5P5, 5P8 2006 - 2022**

Imagen	Clave del Producto y Descripción	Detalles	OEM
	<b>VW12159</b> Buje De Eje	Chasis (Delantero / Trasero) : Trasera Posicion : Izquierda Y Derecha Peso : 0,130 kg / 0.287 lb	1K0505553, 1K0505553A
	<b>AU12024</b> Buje De Torsion	Chasis (Delantero / Trasero) : Trasera Posicion : Izquierda Y Derecha Peso : 0.557 kg / 1.228 lb	1K0505145F, 1K0505145H 1K0505145K
	<b>VW13006K</b> Cubre Polvo De Direccion	Peso : 0.29 kg / 0.639 lb	1K0423831A, 5C0423831

ARONA		KJ7		2017 -	
Imagen	Clave del Producto y Descripción	Detalles	OEM		
	<b>VW3025</b> Terminal interior	Peso : 0,676 kg / 1.490 lb Longitud : 311 mm / 12.24 inch Tamaño de la Rosca : M14X1,5 Diámetro de Cuerda del Perno : M16X1,5	2Q0423810D		
	<b>VW6063</b> Horquilla & Tijera	Peso : 3,004 kg / 6.623 lb Tipo de Material : Chapa Metálica	2Q0407152B		
	<b>VW6063J</b> Horquilla & Tijera	Peso : 2,439 kg / 5.377 lb Tipo de Material : Chapa Metálica	2Q0407152B		
	<b>VW6064</b> Horquilla & Tijera	Peso : 3,004 kg / 6.623 lb Tipo de Material : Chapa Metálica	2Q0407151B		
	<b>VW6064J</b> Horquilla & Tijera	Peso : 2,439 kg / 5.377 lb Tipo de Material : Chapa Metálica	2Q0407151B		
	<b>VW6065</b> Horquilla & Tijera	Peso : 3,57 kg / 7.871 lb Tipo de Material : Chapa Metálica	2Q0407152C		
	<b>VW6065J</b> Horquilla & Tijera	Peso : 2,964 kg / 6.535 lb Tipo de Material : Chapa Metálica	2Q0407152C		
	<b>VW6066</b> Horquilla & Tijera	Peso : 3,57 kg / 7.871 lb Tipo de Material : Chapa Metálica	2Q0407151C		
	<b>VW6066J</b> Horquilla & Tijera	Peso : 2,964 kg / 6.535 lb Tipo de Material : Chapa Metálica	2Q0407151C		

AROSA		6H		1997 - 2004	
Imagen	Clave del Producto y Descripción	Detalles	OEM		
	<b>VW12068K</b> Buje De Torsion	Chasis (Delantero / Trasero) : Trasera Posicion : Izquierda Y Derecha Peso : 0.332 kg / 0.732 lb	6N0501541, 6N0501541D		

\* Nombres de los vehículos, marcas, modelos, símbolos y logos, número OE y otros números de terceros en el sitio web y catálogo solo son con fines de referencia.

**ATECA NU7 2018 -**

Imagen	Clave del Producto y Descripción	Detalles	OEM
	<b>AU11070</b> Buje De Horquilla & Tijera	Chasis (Delantero / Trasero) : Trasera Posicion : Inferior Peso : 0,100 kg / 0.220 lb	5Q0505171, 5Q0505311C 5Q0505311CSK, 5Q0505311D 5Q0505311DSK



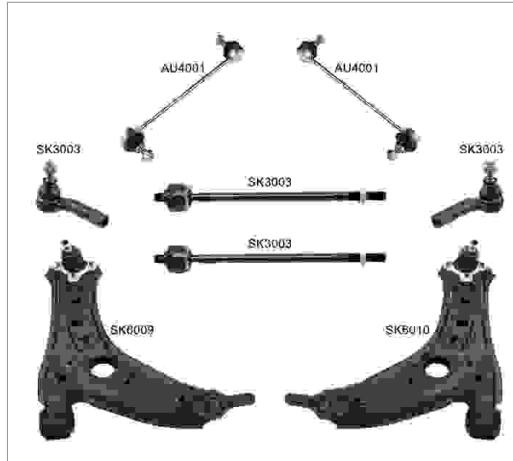

**CORDOBA 6K1, 6K2 1993 - 1999**

Imagen	Clave del Producto y Descripción	Detalles	OEM
	<b>VW12068K</b> Buje De Torsion	Chasis (Delantero / Trasero) : Trasera Posicion : Izquierda Y Derecha Peso : 0.332 kg / 0.732 lb	6N0501541, 6N0501541D





## SK8001 / Kit De Suspension Y Direccion

**CORDOBA**
**6L2**
**2002 - 2009**

### Piezas del Kit

Imagen	RIW Codigo / Nombre	OEM	OEM	RIW Codigo / Nombre	Imagen
	<b>AU4001</b> Tornillo Estabilizador Delantero	893407465, 893407465A 8A0407465, 8A0407465B 8A0407465C	5Z0423812, 6Q0419812C 6Q0423812, 6Q0423812A 6Q0423812C, 6Q0423812D 6R0423812, 8Z0423811A	<b>SK2003</b> Terminal Exterior Frontal Derecho	
	<b>SK2004</b> Terminal Exterior Frontal Izquierdo	5Z0423811, 6Q0419811C 6Q0423811, 6Q0423811A 6Q0423811C, 6Q0423811D 6R0423811, 8Z0423812A	6Q0 423 821 B, 6Q0423821B 6X0422803, 6X0422804 6X0422807, 6X0422821	<b>SK3003</b> Terminal Interior Delantero	
	<b>SK6009</b> Horquillas Frontal Derecho Inferior	6N0407151, 6Q0407151D* 6Q0407151D, 6Q0407151E* 6Q0407151E, 6Q0407151L 6Q0407151Z, 6Q0407366A*	6N040711, 6Q0407151D* 6Q0407151D, 6Q0407151E* 6Q0407151E, 6Q0407151L 6Q0407151Z, 6Q0407365A*	<b>SK6010</b> Horquillas Frontal Inferior Izquierdo	

IBIZA		III 6K1	1999 - 2002
Imagen	Clave del Producto y Descripción	Detalles	OEM
	<b>VW12068K</b> Buje De Torsion	Chasis (Delantero / Trasero) : Trasera Posicion : Izquierda Y Derecha Peso : 0.332 kg / 0.732 lb	6N0501541, 6N0501541D

IBIZA		VI 6F	2017 -
Imagen	Clave del Producto y Descripción	Detalles	OEM
	<b>VW3025</b> Terminal interior	Peso : 0,676 kg / 1.490 lb Longitud : 311 mm / 12.24 inch Tamaño de la Rosca : M14X1,5 Diametro de Cuerda del Perno : M16X1,5	2Q0423810D
	<b>VW6063</b> Horquilla & Tijera	Peso : 3,004 kg / 6.623 lb Tipo de Material : Chapa Metálica	2Q0407152B
	<b>VW6063J</b> Horquilla & Tijera	Peso : 2,439 kg / 5.377 lb Tipo de Material : Chapa Metálica	2Q0407152B
	<b>VW6064</b> Horquilla & Tijera	Peso : 3,004 kg / 6.623 lb Tipo de Material : Chapa Metálica	2Q0407151B
	<b>VW6064J</b> Horquilla & Tijera	Peso : 2,439 kg / 5.377 lb Tipo de Material : Chapa Metálica	2Q0407151B

**VW8003 / Kit De Suspensi?n Y Direcci?n**

**LEON**

**1M1**

**1999 - 2006**



**Piezas del Kit**

Imagen	RIW Codigo / Nombre	OEM	OEM	RIW Codigo / Nombre	Imagen
	<b>AU1014</b> R?tula Frontal Derecho Inferior	1J0407366A, 1J0407366AS 1J0407366B, 1J0407366C 1J0407366D, 1J0407366H	1J0407365A, 1J0407365B 1J0407365C, 1J0407365D	<b>AU1015</b> R?tula Frontal Inferior Izquierdo	
	<b>AU11002</b> Bujes Delantero	1J0407181, 1J0407181A	191407182, 357407182 357407182F	<b>AU11005</b> Bujes Frontal Central	
	<b>VW4011</b> Tornillo Estabilizador Delantero	1J0411315E, 1J0411315G 1J0422315G			

\* Nombres de los vehiculos, marcas, modelos, simbolos y logos, numero OE y otros numeros de terceros en el sitio web y catalogo solo son con fines de referencia.

**LEON 1M1 1999 - 2006**

Imagen	Clave del Producto y Descripción	Detalles	OEM
	<b>VW12159</b> Buje De Eje	Chasis (Delantero / Trasero) : Trasera Posicion : Izquierda Y Derecha Peso : 0,130 kg / 0.287 lb	1K0505553, 1K0505553A
	<b>VW13002K</b> Cubre Polvo De Direccion	Peso : 0.2 kg / 0.441 lb	1J0422831, 1J0422831B 8N0422831

**LEON 1P1 2006 - 2012**

Imagen	Clave del Producto y Descripción	Detalles	OEM
	<b>VW12159</b> Buje De Eje	Chasis (Delantero / Trasero) : Trasera Posicion : Izquierda Y Derecha Peso : 0,130 kg / 0.287 lb	1K0505553, 1K0505553A

**LEON 5F 2012 - 2020**

Imagen	Clave del Producto y Descripción	Detalles	OEM
	<b>AU11070</b> Buje De Horquilla & Tijera	Chasis (Delantero / Trasero) : Trasera Posicion : Inferior Peso : 0,100 kg / 0.220 lb	5Q0505171, 5Q0505311C 5Q0505311CSK, 5Q0505311D 5Q0505311DSK
	<b>VW12159</b> Buje De Eje	Chasis (Delantero / Trasero) : Trasera Posicion : Izquierda Y Derecha Peso : 0,130 kg / 0.287 lb	1K0505553, 1K0505553A
	<b>VW13006K</b> Cubre Polvo De Direccion	Peso : 0.29 kg / 0.639 lb	1K0423831A, 5C0423831

**VW8003 / Kit De Suspensi?n Y Direcci?n**

**TOLEDO**

**II 1M2**

**1999 - 2004**



**Piezas del Kit**

Imagen	RIW Codigo / Nombre	OEM	OEM	RIW Codigo / Nombre	Imagen
	<b>AU1014</b> R?tula Frontal Derecho Inferior	1J0407366A, 1J0407366AS 1J0407366B, 1J0407366C 1J0407366D, 1J0407366H	1J0407365A, 1J0407365B 1J0407365C, 1J0407365D	<b>AU1015</b> R?tula Frontal Inferior Izquierdo	
	<b>AU11002</b> Bujes Delantero	1J0407181, 1J0407181A	191407182, 357407182 357407182F	<b>AU11005</b> Bujes Frontal Central	
	<b>VW4011</b> Tornillo Estabilizador Delantero	1J0411315E, 1J0411315G 1J0422315G			



\* Nombres de los vehiculos, marcas, modelos, simbolos y logos, numero OE y otros numeros de terceros en el sitio web y catalogo solo son con fines de referencia.



**TOLEDO**
**II 1M2**
**1999 - 2004**

Imagen	Clave del Producto y Descripción	Detalles	OEM
	<b>VW13002K</b> Cubre Polvo De Direccion	Peso : 0.2 kg / 0.441 lb	1J0422831, 1J0422831B 8N0422831
	<b>VW13006K</b> Cubre Polvo De Direccion	Peso : 0.29 kg / 0.639 lb	1K0423831A, 5C0423831

**TOLEDO**
**III 5P2**
**2004 - 2009**

Imagen	Clave del Producto y Descripción	Detalles	OEM
	<b>VW12159</b> Buje De Eje	Chasis (Delantero / Trasero) : Trasera Posicion : Izquierda Y Derecha Peso : 0,130 kg / 0.287 lb	1K0505553, 1K0505553A
	<b>VW13006K</b> Cubre Polvo De Direccion	Peso : 0.29 kg / 0.639 lb	1K0423831A, 5C0423831

**RIW<sup>®</sup>**

**SKODA**







**SK8001 / Kit De Suspension Y Direccion**
**FABIA**
**I 6Y2**
**1999 - 2006**

**Piezas del Kit**

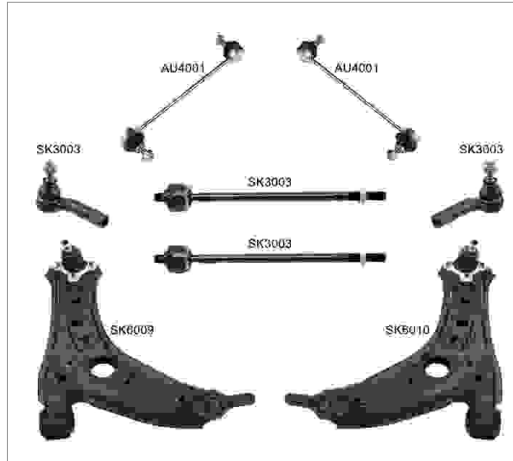
Imagen	RIW Codigo / Nombre	OEM	OEM	RIW Codigo / Nombre	Imagen
	<b>AU4001</b> Tornillo Estabilizador Delantero	893407465, 893407465A 8A0407465, 8A0407465B 8A0407465C	5Z0423812, 6Q0419812C 6Q0423812, 6Q0423812A 6Q0423812C, 6Q0423812D 6R0423812, 8Z0423811A	<b>SK2003</b> Terminal Exterior Frontal Derecho	
	<b>SK2004</b> Terminal Exterior Frontal Izquierdo	5Z0423811, 6Q0419811C 6Q0423811, 6Q0423811A 6Q0423811C, 6Q0423811D 6R0423811, 8Z0423812A	6Q0 423 821 B, 6Q0423821B 6X0422803, 6X0422804 6X0422807, 6X0422821	<b>SK3003</b> Terminal Interior Delantero	
	<b>SK6009</b> Horquillas Frontal Derecho Inferior	6N0407151, 6Q0407151D* 6Q0407151D, 6Q0407151E* 6Q0407151E, 6Q0407151L 6Q0407151Z, 6Q0407366A*	6N040711, 6Q0407151D* 6Q0407151D, 6Q0407151E* 6Q0407151E, 6Q0407151L 6Q0407151Z, 6Q0407365A*	<b>SK6010</b> Horquillas Frontal Inferior Izquierdo	







**SK8001 / Kit De Suspension Y Direccion**
**FABIA**
**I COMBI 6Y5**
**2000 - 2007**

**Piezas del Kit**

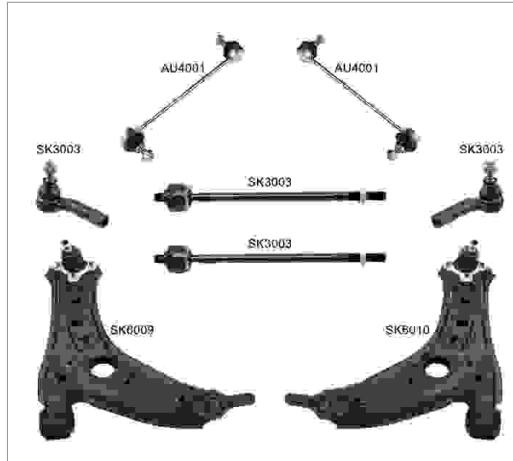
Imagen	RIWCodigo / Nombre	OEM	OEM	RIWCodigo / Nombre	Imagen
	<b>AU4001</b> Tornillo Estabilizador Delantero	893407465, 893407465A 8A0407465, 8A0407465B 8A0407465C	5Z0423812, 6Q0419812C 6Q0423812, 6Q0423812A 6Q0423812C, 6Q0423812D 6R0423812, 8Z0423811A	<b>SK2003</b> Terminal Exterior Frontal Derecho	
	<b>SK2004</b> Terminal Exterior Frontal Izquierdo	5Z0423811, 6Q0419811C 6Q0423811, 6Q0423811A 6Q0423811C, 6Q0423811D 6R0423811, 8Z0423812A	6Q0 423 821 B, 6Q0423821B 6X0422803, 6X0422804 6X0422807, 6X0422821	<b>SK3003</b> Terminal Interior Delantero	
	<b>SK6009</b> Horquillas Frontal Derecho Inferior	6N0407151, 6Q0407151D* 6Q0407151D, 6Q0407151E* 6Q0407151E, 6Q0407151L 6Q0407151Z, 6Q0407366A*	6N040711, 6Q0407151D* 6Q0407151D, 6Q0407151E* 6Q0407151E, 6Q0407151L 6Q0407151Z, 6Q0407365A*	<b>SK6010</b> Horquillas Frontal Inferior Izquierdo	



**SK8001 / Kit De Suspension Y Direccion**
**FABIA**
**I PRAKTIK 6Y5**
**2001 - 2007**

**Piezas del Kit**

Imagen	RIW Codigo / Nombre	OEM	OEM	RIW Codigo / Nombre	Imagen
	<b>AU4001</b> Tornillo Estabilizador Delantero	893407465, 893407465A 8A0407465, 8A0407465B 8A0407465C	5Z0423812, 6Q0419812C 6Q0423812, 6Q0423812A 6Q0423812C, 6Q0423812D 6R0423812, 8Z0423811A	<b>SK2003</b> Terminal Exterior Frontal Derecho	
	<b>SK2004</b> Terminal Exterior Frontal Izquierdo	5Z0423811, 6Q0419811C 6Q0423811, 6Q0423811A 6Q0423811C, 6Q0423811D 6R0423811, 8Z0423812A	6Q0 423 821 B, 6Q0423821B 6X0422803, 6X0422804 6X0422807, 6X0422821	<b>SK3003</b> Terminal Interior Delantero	
	<b>SK6009</b> Horquillas Frontal Derecho Inferior	6N0407151, 6Q0407151D* 6Q0407151D, 6Q0407151E* 6Q0407151E, 6Q0407151L 6Q0407151Z, 6Q0407366A*	6N040711, 6Q0407151D* 6Q0407151D, 6Q0407151E* 6Q0407151E, 6Q0407151L 6Q0407151Z, 6Q0407365A*	<b>SK6010</b> Horquillas Frontal Inferior Izquierdo	



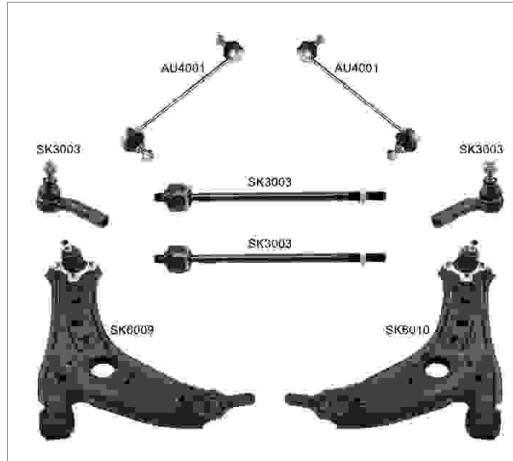

**SK8001 / Kit De Suspension Y Direccion**
**FABIA**
**I SALOON 6Y3**
**1999 - 2006**

**Piezas del Kit**

Imagen	RIW Codigo / Nombre	OEM	OEM	RIW Codigo / Nombre	Imagen
	<b>AU4001</b> Tornillo Estabilizador Delantero	893407465, 893407465A 8A0407465, 8A0407465B 8A0407465C	5Z0423812, 6Q0419812C 6Q0423812, 6Q0423812A 6Q0423812C, 6Q0423812D 6R0423812, 8Z0423811A	<b>SK2003</b> Terminal Exterior Frontal Derecho	
	<b>SK2004</b> Terminal Exterior Frontal Izquierdo	5Z0423811, 6Q0419811C 6Q0423811, 6Q0423811A 6Q0423811C, 6Q0423811D 6R0423811, 8Z0423812A	6Q0 423 821 B, 6Q0423821B 6X0422803, 6X0422804 6X0422807, 6X0422821	<b>SK3003</b> Terminal Interior Delantero	
	<b>SK6009</b> Horquillas Frontal Derecho Inferior	6N0407151, 6Q0407151D* 6Q0407151D, 6Q0407151E* 6Q0407151E, 6Q0407151L 6Q0407151Z, 6Q0407366A*	6N040711, 6Q0407151D* 6Q0407151D, 6Q0407151E* 6Q0407151E, 6Q0407151L 6Q0407151Z, 6Q0407365A*	<b>SK6010</b> Horquillas Frontal Inferior Izquierdo	

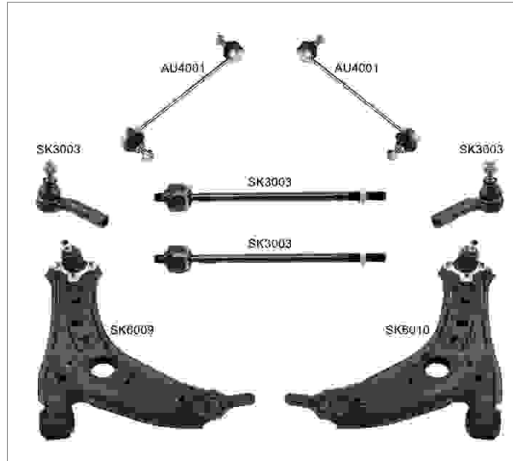
**KAROQ NU7 2017 -**

Imagen	Clave del Producto y Descripción	Detalles	OEM
	<b>AU11070</b> Buje De Horquilla & Tijera	Chasis (Delantero / Trasero) : Trasera Posicion : Inferior Peso : 0,100 kg / 0.220 lb	5Q0505171, 5Q0505311C 5Q0505311CSK, 5Q0505311D 5Q0505311DSK

**OCTAVIA I 1U2 1996 - 2004**

Imagen	Clave del Producto y Descripción	Detalles	OEM
	<b>VW13002K</b> Cubre Polvo De Direccion	Peso : 0.2 kg / 0.441 lb	1J0422831, 1J0422831B 8N0422831
	<b>VW13006K</b> Cubre Polvo De Direccion	Peso : 0.29 kg / 0.639 lb	1K0423831A, 5C0423831

**OCTAVIA I COMBI 1U5 1996 - 2004**





Imagen	Clave del Producto y Descripción	Detalles	OEM
	<b>VW13002K</b> Cubre Polvo De Direccion	Peso : 0.2 kg / 0.441 lb	1J0422831, 1J0422831B 8N0422831
	<b>VW13006K</b> Cubre Polvo De Direccion	Peso : 0.29 kg / 0.639 lb	1K0423831A, 5C0423831

**OCTAVIA II 1Z3 2004 - 2013**

Imagen	Clave del Producto y Descripción	Detalles	OEM
	<b>VW12159</b> Buje De Eje	Chasis (Delantero / Trasero) : Trasera Posicion : Izquierda Y Derecha Peso : 0,130 kg / 0.287 lb	1K0505553, 1K0505553A
	<b>VW13002K</b> Cubre Polvo De Direccion	Peso : 0.2 kg / 0.441 lb	1J0422831, 1J0422831B 8N0422831
	<b>VW13006K</b> Cubre Polvo De Direccion	Peso : 0.29 kg / 0.639 lb	1K0423831A, 5C0423831

\* Nombres de los vehiculos, marcas, modelos, simbolos y logos, numero OE y otros numeros de terceros en el sitio web y catalogo solo son con fines de referencia.

**OCTAVIA II COMBI 1Z5 2004 - 2013**

Imagen	Clave del Producto y Descripción	Detalles	OEM
	<b>VW12159</b> Buje De Eje	Chasis (Delantero / Trasero) : Trasera Posicion : Izquierda Y Derecha Peso : 0,130 kg / 0.287 lb	1K0505553, 1K0505553A
	<b>AU12024</b> Buje De Torsion	Chasis (Delantero / Trasero) : Trasera Posicion : Izquierda Y Derecha Peso : 0.557 kg / 1.228 lb	1K0505145F, 1K0505145H 1K0505145K
	<b>VW13002K</b> Cubre Polvo De Direccion	Peso : 0.2 kg / 0.441 lb	1J0422831, 1J0422831B 8N0422831
	<b>VW13006K</b> Cubre Polvo De Direccion	Peso : 0.29 kg / 0.639 lb	1K0423831A, 5C0423831

**OCTAVIA III 5E3 2012 - 2020**

Imagen	Clave del Producto y Descripción	Detalles	OEM
	<b>AU11070</b> Buje De Horquilla & Tijera	Chasis (Delantero / Trasero) : Trasera Posicion : Inferior Peso : 0,100 kg / 0.220 lb	5Q0505171, 5Q0505311C 5Q0505311CSK, 5Q0505311D 5Q0505311DSK
	<b>VW12159</b> Buje De Eje	Chasis (Delantero / Trasero) : Trasera Posicion : Izquierda Y Derecha Peso : 0,130 kg / 0.287 lb	1K0505553, 1K0505553A
	<b>VW13006K</b> Cubre Polvo De Direccion	Peso : 0.29 kg / 0.639 lb	1K0423831A, 5C0423831

**OCTAVIA III COMBI 5E5 2012 - 2020**

Imagen	Clave del Producto y Descripción	Detalles	OEM
	<b>AU11070</b> Buje De Horquilla & Tijera	Chasis (Delantero / Trasero) : Trasera Posicion : Inferior Peso : 0,100 kg / 0.220 lb	5Q0505171, 5Q0505311C 5Q0505311CSK, 5Q0505311D 5Q0505311DSK
	<b>VW12159</b> Buje De Eje	Chasis (Delantero / Trasero) : Trasera Posicion : Izquierda Y Derecha Peso : 0,130 kg / 0.287 lb	1K0505553, 1K0505553A

\* Nombres de los vehiculos, marcas, modelos, simbolos y logos, numero OE y otros numeros de terceros en el sitio web y catalogo solo son con fines de referencia.



**OCTAVIA III COMBI 5E5 2012 - 2020**

Imagen	Clave del Producto y Descripción	Detalles	OEM
	<b>VW13006K</b> Cubre Polvo De Direccion	Peso : 0.29 kg / 0.639 lb	1K0423831A, 5C0423831

**SUPERB II 3T4 2008 - 2015**

Imagen	Clave del Producto y Descripción	Detalles	OEM
	<b>VW12159</b> Buje De Eje	Chasis (Delantero / Trasero) : Trasera Posicion : Izquierda Y Derecha Peso : 0,130 kg / 0.287 lb	1K0505553, 1K0505553A
	<b>AU12024</b> Buje De Torsion	Chasis (Delantero / Trasero) : Trasera Posicion : Izquierda Y Derecha Peso : 0.557 kg / 1.228 lb	1K0505145F, 1K0505145H 1K0505145K
	<b>VW13006K</b> Cubre Polvo De Direccion	Peso : 0.29 kg / 0.639 lb	1K0423831A, 5C0423831

**SUPERB II ESTATE 3T5 2008 - 2015**

Imagen	Clave del Producto y Descripción	Detalles	OEM
	<b>VW12159</b> Buje De Eje	Chasis (Delantero / Trasero) : Trasera Posicion : Izquierda Y Derecha Peso : 0,130 kg / 0.287 lb	1K0505553, 1K0505553A
	<b>AU12024</b> Buje De Torsion	Chasis (Delantero / Trasero) : Trasera Posicion : Izquierda Y Derecha Peso : 0.557 kg / 1.228 lb	1K0505145F, 1K0505145H 1K0505145K
	<b>VW13006K</b> Cubre Polvo De Direccion	Peso : 0.29 kg / 0.639 lb	1K0423831A, 5C0423831

**SUPERB III 3V3 2015 - 2024**

Imagen	Clave del Producto y Descripción	Detalles	OEM
	<b>VW9006</b> Horquilla & Tijera	Peso : 1,992 kg / 4.392 lb Tipo de Material : Chapa Metálica	3Q0505224

\* Nombres de los vehículos, marcas, modelos, símbolos y logos, número OE y otros números de terceros en el sitio web y catálogo solo son con fines de referencia.

**SUPERB III 3V3 2015 - 2024**

Imagen	Clave del Producto y Descripción	Detalles	OEM
	<b>VW9007</b> Horquilla & Tijera	Peso : 1,992 kg / 4.392 lb Tipo de Material : Chapa Metálica	3Q0505223
	<b>VW13006K</b> Cubre Polvo De Direccion	Peso : 0.29 kg / 0.639 lb	1K0423831A, 5C0423831

**SUPERB III ESTATE 3V5 2015 - 2024**

Imagen	Clave del Producto y Descripción	Detalles	OEM
	<b>VW9006</b> Horquilla & Tijera	Peso : 1,992 kg / 4.392 lb Tipo de Material : Chapa Metálica	3Q0505224
	<b>VW9007</b> Horquilla & Tijera	Peso : 1,992 kg / 4.392 lb Tipo de Material : Chapa Metálica	3Q0505223
	<b>VW13006K</b> Cubre Polvo De Direccion	Peso : 0.29 kg / 0.639 lb	1K0423831A, 5C0423831

**YETI 5L 2009 - 2017**

Imagen	Clave del Producto y Descripción	Detalles	OEM
	<b>VW12159</b> Buje De Eje	Chasis (Delantero / Trasero) : Trasera Posicion : Izquierda Y Derecha Peso : 0,130 kg / 0.287 lb	1K0505553, 1K0505553A
	<b>AU12024</b> Buje De Torsion	Chasis (Delantero / Trasero) : Trasera Posicion : Izquierda Y Derecha Peso : 0.557 kg / 1.228 lb	1K0505145F, 1K0505145H 1K0505145K
	<b>VW13006K</b> Cubre Polvo De Direccion	Peso : 0.29 kg / 0.639 lb	1K0423831A, 5C0423831

**RIW<sup>®</sup>**

**SMART**

**CITY COUPE MC01 1998 - 2004**

Imagen	Clave del Producto y Descripción	Detalles	OEM
	<b>SM11004</b> Buje De Horquilla & Tijera	Chasis (Delantero / Trasero) : Trasera Posicion : Trasera Peso : 0.103 kg / 0.227 lb	1765V005, 1765V005000000 Q1765V005, Q1765V005000000
	<b>SM11005</b> Buje De Horquilla & Tijera	Chasis (Delantero / Trasero) : Trasera Posicion : Trasera Peso : 0.1 kg / 0.220 lb	1765V005, 1765V005000000 Q1765V005, Q1765V005000000

**FORFOUR 453 2015 -**

Imagen	Clave del Producto y Descripción	Detalles	OEM
	<b>SM2003</b> Terminal Exterior	Peso : 0,358 kg / 0.789 lb Longitud : 90 mm / 3.54 inch	45333-07000
	<b>SM2004</b> Terminal Exterior	Peso : 0,358 kg / 0.789 lb Longitud : 90 mm / 3.54 inch	45333-07100

**FORTWO 450 2004 - 2006**





Imagen	Clave del Producto y Descripción	Detalles	OEM
	<b>SM11004</b> Buje De Horquilla & Tijera	Chasis (Delantero / Trasero) : Trasera Posicion : Trasera Peso : 0.103 kg / 0.227 lb	1765V005, 1765V005000000 Q1765V005, Q1765V005000000
	<b>SM11005</b> Buje De Horquilla & Tijera	Chasis (Delantero / Trasero) : Trasera Posicion : Trasera Peso : 0.1 kg / 0.220 lb	1765V005, 1765V005000000 Q1765V005, Q1765V005000000

**FORTWO 453 2015 -**

Imagen	Clave del Producto y Descripción	Detalles	OEM
	<b>SM2003</b> Terminal Exterior	Peso : 0,358 kg / 0.789 lb Longitud : 90 mm / 3.54 inch	45333-07000
	<b>SM2004</b> Terminal Exterior	Peso : 0,358 kg / 0.789 lb Longitud : 90 mm / 3.54 inch	45333-07100

\* Nombres de los vehículos, marcas, modelos, símbolos y logos, número OE y otros números de terceros en el sitio web y catálogo solo son con fines de referencia.

**FORTWO 453 2015 -**

Imagen	Clave del Producto y Descripción	Detalles	OEM
	<b>SM3003</b> Terminal interior	Peso : 0,654 kg / 1.442 lb Longitud : 392,5 mm / 15.45 inch	Part of 4534630000, Part of 485215653R
	<b>SM6007</b> Horquilla & Tijera	Peso : 2,235 kg / 4.927 lb Tipo de Material : Chapa Metálica	4533303000, 545047654R
	<b>SM6008</b> Horquilla & Tijera	Peso : 2,235 kg / 4.927 lb Tipo de Material : Chapa Metálica	4533302900, 545051097R
	<b>SM6009</b> Horquilla & Tijera	Peso : 2,731 kg / 6.021 lb Tipo de Material : Chapa Metálica	4533303200, 545048628R
	<b>SM6010</b> Horquilla & Tijera	Peso : 2,235 kg / 4.927 lb Tipo de Material : Chapa Metálica	4533303100, 545057345R

**ROADSTER 452 2003 - 2005**

Imagen	Clave del Producto y Descripción	Detalles	OEM
	<b>SM11004</b> Buje De Horquilla & Tijera	Chasis (Delantero / Trasero) : Trasera Posicion : Trasera Peso : 0.103 kg / 0.227 lb	1765V005, 1765V005000000 Q1765V005, Q1765V005000000
	<b>SM11005</b> Buje De Horquilla & Tijera	Chasis (Delantero / Trasero) : Trasera Posicion : Trasera Peso : 0.1 kg / 0.220 lb	1765V005, 1765V005000000 Q1765V005, Q1765V005000000

**RIW<sup>®</sup>**

**SOUEAST**

**SAVRIN**
**1997 - 2003**

Imagen	Clave del Producto y Descripción	Detalles	OEM
	<b>MI4037</b> Tornillo Estabilizador	Peso : 0,210 kg / 0.463 lb Longitud : 140 mm / 5.51 inch Nota : FOR SPORT MODEL	4056A138, MR344624 MR555883, MR586053
	<b>MI4038</b> Tornillo Estabilizador	Peso : 0,398 kg / 0.877 lb Tipo de Material : Metal Longitud : 240 mm / 9.45 inch	4056A035, MR316436
	<b>MI4039</b> Tornillo Estabilizador	Peso : 0,398 kg / 0.877 lb Tipo de Material : Metal Longitud : 240 mm / 9.45 inch	4056A034, MR316435

**RIW®**

**SUBARU**







**BAJA**
**2003 - 2006**

Imagen	Clave del Producto y Descripción	Detalles	OEM
	<b>HN4060</b> Tornillo Estabilizador	Peso : 0,234 kg / 0.516 lb Tipo de Material : Metal Longitud : 92 mm / 3.62 inch	20470-AE00C, 52320-S2A-003

**BRZ**
**2013 - 2020**

Imagen	Clave del Producto y Descripción	Detalles	OEM
	<b>SU1007</b> Rotula	Peso : 0,260 kg / 0.573 lb	20202-CA010*, 20206-CA000* SU00300358
	<b>SU3011</b> Terminal interior	Peso : 0,476 kg / 1.049 lb Longitud : 226.5 mm / 8.92 inch	34160CA000, SU00300832

**FORESTER**
**SG**
**2002 - 2007**



Imagen	Clave del Producto y Descripción	Detalles	OEM
	<b>SU6007</b> Horquilla & Tijera	Peso : 5,052 kg / 11.138 lb Tipo de Material : Chapa Metálica	20202SA000, 20202SA001
	<b>SU6007J</b> Horquilla & Tijera	Peso : 4,776 kg / 10.529 lb Tipo de Material : Chapa Metálica	20202SA000*, 20202SA001*
	<b>SU6008</b> Horquilla & Tijera	Peso : 5,052 kg / 11.138 lb Tipo de Material : Chapa Metálica	20202SA010, 20202SA011
	<b>SU6008J</b> Horquilla & Tijera	Peso : 4,776 kg / 10.529 lb Tipo de Material : Chapa Metálica	20202SA010*, 20202SA011*

**FORESTER**
**SH**
**2008 - 2013**

Imagen	Clave del Producto y Descripción	Detalles	OEM
	<b>SU6009</b> Horquilla & Tijera	Peso : 4,003 kg / 8.825 lb Tipo de Material : Chapa Metálica	20202SC000, 20202SC001 20202SC002

\* Nombres de los vehículos, marcas, modelos, símbolos y logos, número OE y otros números de terceros en el sitio web y catálogo solo son con fines de referencia.

**FORESTER SH 2008 - 2013**

Imagen	Clave del Producto y Descripción	Detalles	OEM
	<b>SU6010</b> Horquilla & Tijera	Peso : 4,003 kg / 8.825 lb Tipo de Material : Chapa Metálica	20202SC010, 20202SC011 20202SC012
	<b>SU11001</b> Buje De Horquilla & Tijera	Chasis (Delantero / Trasero) : Trasera Posicion : Peso : 0,159 kg / 0.351 lb	2020FG020*

**FORESTER SJ 2013 - 2019**

Imagen	Clave del Producto y Descripción	Detalles	OEM
	<b>SU3002</b> Terminal interior	Peso : 0,607 kg / 1.338 lb Longitud : 325 mm / 12.80 inch	34160SC020

**FORESTER SK 2018 -**

Imagen	Clave del Producto y Descripción	Detalles	OEM
	<b>SU3002</b> Terminal interior	Peso : 0,607 kg / 1.338 lb Longitud : 325 mm / 12.80 inch	34160SC020
	<b>SU11001</b> Buje De Horquilla & Tijera	Chasis (Delantero / Trasero) : Trasera Posicion : Peso : 0,159 kg / 0.351 lb	2020FG020*

**IMPREZA GE, GH, GR, GV 2008 - 2011**

Imagen	Clave del Producto y Descripción	Detalles	OEM
	<b>SU11001</b> Buje De Horquilla & Tijera	Chasis (Delantero / Trasero) : Trasera Posicion : Peso : 0,159 kg / 0.351 lb	2020FG020*

**IMPREZA GK, GT 2017 - 2023**

Imagen	Clave del Producto y Descripción	Detalles	OEM
	<b>SU11001</b> Buje De Horquilla & Tijera	Chasis (Delantero / Trasero) : Trasera Posicion : Peso : 0,159 kg / 0.351 lb	2020FG020*

\* Nombres de los vehículos, marcas, modelos, símbolos y logos, número OE y otros números de terceros en el sitio web y catálogo solo son con fines de referencia.

**LEGACY V BM, BR 2010 - 2014**

Imagen	Clave del Producto y Descripción	Detalles	OEM
	<b>SU6005</b> Horquilla & Tijera	Peso : 4,020 kg / 8.863 lb Tipo de Material : Chapa Metálica	20202-AJ00A, 20202-AJ00B 20202-AJ00C, 20202-AJ04A 20202-AJ08A
	<b>SU6005J</b> Horquilla & Tijera	Peso : 3,744 kg / 8.254 lb Tipo de Material : Chapa Metálica	20202-AJ00A, 20202-AJ00B 20202-AJ00C, 20202-AJ04A 20202-AJ08A
	<b>SU6006</b> Horquilla & Tijera	Peso : 4,020 kg / 8.863 lb Tipo de Material : Chapa Metálica	20202-AJ01A, 20202-AJ01B 20202-AJ01C, 20202-AJ05A 20202-AJ09A
	<b>SU6006J</b> Horquilla & Tijera	Peso : 3,744 kg / 8.254 lb Tipo de Material : Chapa Metálica	20202-AJ01A, 20202-AJ01B 20202-AJ01C, 20202-AJ05A 20202-AJ09A

**LEGACY VI BN, BS 2015 - 2020**

Imagen	Clave del Producto y Descripción	Detalles	OEM
	<b>SU11001</b> Buje De Horquilla & Tijera	Chasis (Delantero / Trasero) : Trasera Posicion : Peso : 0,159 kg / 0.351 lb	2020FG020*

**LEGACY VII 2020 -**

Imagen	Clave del Producto y Descripción	Detalles	OEM
	<b>SU11001</b> Buje De Horquilla & Tijera	Chasis (Delantero / Trasero) : Trasera Posicion : Peso : 0,159 kg / 0.351 lb	2020FG020*

**OUTBACK BP 2004 - 2009**

Imagen	Clave del Producto y Descripción	Detalles	OEM
	<b>HN4060</b> Tornillo Estabilizador	Peso : 0,234 kg / 0.516 lb Tipo de Material : Metal Longitud : 92 mm / 3.62 inch	20470-AE00C, 52320-S2A-003

**OUTBACK BR 2009 - 2014**

Imagen	Clave del Producto y Descripción	Detalles	OEM
	<b>SU6005</b> Horquilla & Tijera	Peso : 4,020 kg / 8.863 lb Tipo de Material : Chapa Metálica	20202-AJ00A, 20202-AJ00B 20202-AJ00C, 20202-AJ04A 20202-AJ08A
	<b>SU6005J</b> Horquilla & Tijera	Peso : 3,744 kg / 8.254 lb Tipo de Material : Chapa Metálica	20202-AJ00A, 20202-AJ00B 20202-AJ00C, 20202-AJ04A 20202-AJ08A
	<b>SU6006</b> Horquilla & Tijera	Peso : 4,020 kg / 8.863 lb Tipo de Material : Chapa Metálica	20202-AJ01A, 20202-AJ01B 20202-AJ01C, 20202-AJ05A 20202-AJ09A
	<b>SU6006J</b> Horquilla & Tijera	Peso : 3,744 kg / 8.254 lb Tipo de Material : Chapa Metálica	20202-AJ01A, 20202-AJ01B 20202-AJ01C, 20202-AJ05A 20202-AJ09A
	<b>SU11001</b> Buje De Horquilla & Tijera	Chasis (Delantero / Trasero) : Trasera Posicion : Peso : 0,159 kg / 0.351 lb	2020FG020*

**OUTBACK BT 2020 -**

Imagen	Clave del Producto y Descripción	Detalles	OEM
	<b>SU11001</b> Buje De Horquilla & Tijera	Chasis (Delantero / Trasero) : Trasera Posicion : Peso : 0,159 kg / 0.351 lb	2020FG020*

**XV GP 2012 - 2017**

Imagen	Clave del Producto y Descripción	Detalles	OEM
	<b>SU3002</b> Terminal interior	Peso : 0,607 kg / 1.338 lb Longitud : 325 mm / 12.80 inch	34160SC020
	<b>SU6011</b> Horquilla & Tijera	Peso : 4,106 kg / 9.052 lb Tipo de Material : Chapa Metálica	20202FJ040
	<b>SU6012</b> Horquilla & Tijera	Peso : 4,106 kg / 9.052 lb Tipo de Material : Chapa Metálica	20202FJ050

\* Nombres de los vehículos, marcas, modelos, símbolos y logos, número OE y otros números de terceros en el sitio web y catálogo solo son con fines de referencia.

**XV GP 2012 - 2017**

Imagen	Clave del Producto y Descripción	Detalles	OEM
	<b>SU11001</b> Buje De Horquilla & Tijera	Chasis (Delantero / Trasero) : Trasera Posicion : Peso : 0,159 kg / 0.351 lb	2020FG020*

**XV GT 2018 - 2023**

Imagen	Clave del Producto y Descripción	Detalles	OEM
	<b>SU3002</b> Terminal interior	Peso : 0,607 kg / 1.338 lb Longitud : 325 mm / 12.80 inch	34160SC020
	<b>SU11001</b> Buje De Horquilla & Tijera	Chasis (Delantero / Trasero) : Trasera Posicion : Peso : 0,159 kg / 0.351 lb	2020FG020*

**RIW<sup>®</sup>**

**SUZUKI**

**SX4** **GY** **2006 - 2013**

Imagen	Clave del Producto y Descripción	Detalles	OEM
	<p><b>F111062</b> Buje De Horquilla &amp; Tijera</p>	<p>Chasis (Delantero / Trasero) : Delantero Posicion : Inferior Peso : 0.186 kg / 0.410 lb</p>	<p>45261-79J00, 71742733</p>
	<p><b>F111063</b> Buje De Horquilla &amp; Tijera</p>	<p>Chasis (Delantero / Trasero) : Delantero Posicion : Inferior Peso : 0.12 kg / 0.265 lb</p>	<p>Part of 71742731, Part of 71742732</p>

\* Nombres de los vehiculos, marcas, modelos, simbolos y logos, numero OE y otros numeros de terceros en el sitio web y catalogo solo son con fines de referencia.

**RIW<sup>®</sup>**

**TOYOTA**



**4RUNNER N1 1989 - 1995**

Imagen	Clave del Producto y Descripción	Detalles	OEM
	<b>TO1056</b> Rotula	Peso : 0,904 kg / 1.993 lb	43330-39265, 43340-39245
	<b>TO4082</b> Tornillo Estabilizador	Peso : 0,287 kg / 0.633 lb Longitud : 150 mm / 5.91 inch	4882035010



**4RUNNER N18 1995 - 2002**

Imagen	Clave del Producto y Descripción	Detalles	OEM
	<b>TO4081</b> Tornillo Estabilizador	Peso : 0,292 kg / 0.644 lb Longitud : 153,5 mm / 6.04 inch	4883035020

**4RUNNER N21 2002 - 2009**

Imagen	Clave del Producto y Descripción	Detalles	OEM
	<b>TO1057</b> Rotula	Peso : 0,663 kg / 1.462 lb	4806860040*, 4806960040*

**ARISTO S16 1997 - 2005**

Imagen	Clave del Producto y Descripción	Detalles	OEM
	<b>LX1001</b> Rotula	Peso : 0,998 kg / 2.200 lb	4333039455, 4333039535
	<b>LX1002</b> Rotula	Peso : 0,998 kg / 2.200 lb	4334039345, 4334039415
	<b>LX3003</b> Terminal interior	Peso : 0,504 kg / 1.111 lb Longitud : 222,5 mm / 8.76 inch	4550339155

**AURIS I E15 2007 - 2013**

Imagen	Clave del Producto y Descripción	Detalles	OEM
	<b>TO9010</b> Horquilla & Tijera	Peso : 0,962 kg / 2.121 lb Tipo de Material : Acero Forjado	4871005090
	<b>TO9016</b> Horquilla & Tijera	Peso : 1,440 kg / 3.175 lb Tipo de Material : Chapa Metálica	4877012010

**AURIS II E18 2013 - 2019**

Imagen	Clave del Producto y Descripción	Detalles	OEM
	<b>TO9010</b> Horquilla & Tijera	Peso : 0,962 kg / 2.121 lb Tipo de Material : Acero Forjado	4871005090
	<b>TO9016</b> Horquilla & Tijera	Peso : 1,440 kg / 3.175 lb Tipo de Material : Chapa Metálica	4877012010

**AVALON XX10, XX20 1995 - 2004**



Imagen	Clave del Producto y Descripción	Detalles	OEM
	<b>TO20023830</b> Terminales Completas	Peso : 1,050 kg / 2.315 lb Terminal Exterior : TO2002 Terminal Interior : TO3830	
	<b>TO10001</b> Buje De Horquilla & Tijera	Chasis (Delantero / Trasero) : Trasera Posicion : Inferior Peso : 0.169 kg / 0.373 lb	Part of 4871006040, Part of 4871006120 Part of 4873007020, Part of 4873007040 Part of 4873033110

**AVALON XX30 2005 - 2012**

Imagen	Clave del Producto y Descripción	Detalles	OEM
	<b>TO9014</b> Horquilla & Tijera	Peso : 0,936 kg / 2.064 lb Tipo de Material : Tubo De Acero	4871006040, 4871006120 4873007020, 4873007040 4873033110
	<b>TO9015</b> Horquilla & Tijera	Peso : 0,830 kg / 1.830 lb Tipo de Material : Tubo De Acero	4871006110, 4871006130 4871007010, 4871033130

\* Nombres de los vehículos, marcas, modelos, símbolos y logos, número OE y otros números de terceros en el sitio web y catálogo solo son con fines de referencia.

**AVALON XX30 2005 - 2012**

Imagen	Clave del Producto y Descripción	Detalles	OEM
	<b>TO9017</b> Horquilla & Tijera	Peso : 1,280 kg / 2.822 lb Tipo de Material : Tubo De Acero	4873007040, 4873033100
	<b>TO9018</b> Horquilla & Tijera	Peso : 1,280 kg / 2.822 lb Tipo de Material : Tubo De Acero	4874007020, 4874033100
	<b>TO10001</b> Buje De Horquilla & Tijera	Chasis (Delantero / Trasero) : Trasera Posicion : Inferior Peso : 0.169 kg / 0.373 lb	Part of 4871006040, Part of 4871006120 Part of 4873007020, Part of 4873007040 Part of 4873033110

**AVENSIS III T27 2009 - 2015**

Imagen	Clave del Producto y Descripción	Detalles	OEM
	<b>TO9010</b> Horquilla & Tijera	Peso : 0,962 kg / 2.121 lb Tipo de Material : Acero Forjado	4871005090
	<b>TO9016</b> Horquilla & Tijera	Peso : 1,440 kg / 3.175 lb Tipo de Material : Chapa Metálica	4877012010

**CAMRY I XV10 1991 - 1996**

Imagen	Clave del Producto y Descripción	Detalles	OEM
	<b>TO20023830</b> Terminales Completas	Peso : 1,050 kg / 2.315 lb Terminal Exterior : TO2002 Terminal Interior : TO3830	

**CAMRY II XV20 1996 - 2001**

Imagen	Clave del Producto y Descripción	Detalles	OEM
	<b>TO20023830</b> Terminales Completas	Peso : 1,050 kg / 2.315 lb Terminal Exterior : TO2002 Terminal Interior : TO3830	
	<b>TO10001</b> Buje De Horquilla & Tijera	Chasis (Delantero / Trasero) : Trasera Posicion : Inferior Peso : 0.169 kg / 0.373 lb	Part of 4871006040, Part of 4871006120 Part of 4873007020, Part of 4873007040 Part of 4873033110

\* Nombres de los vehículos, marcas, modelos, símbolos y logos, número OE y otros números de terceros en el sitio web y catálogo solo son con fines de referencia.

**CAMRY IV XV40 2007 - 2011**

Imagen	Clave del Producto y Descripción	Detalles	OEM
	<b>TO9014</b> Horquilla & Tijera	Peso : 0,936 kg / 2.064 lb Tipo de Material : Tubo De Acero	4871006040, 4871006120 4873007020, 4873007040 4873033110
	<b>TO9015</b> Horquilla & Tijera	Peso : 0,830 kg / 1.830 lb Tipo de Material : Tubo De Acero	4871006110, 4871006130 4871007010, 4871033130
	<b>TO9017</b> Horquilla & Tijera	Peso : 1,280 kg / 2.822 lb Tipo de Material : Tubo De Acero	4873007040, 4873033100
	<b>TO9018</b> Horquilla & Tijera	Peso : 1,280 kg / 2.822 lb Tipo de Material : Tubo De Acero	4874007020, 4874033100
	<b>TO10001</b> Buje De Horquilla & Tijera	Chasis (Delantero / Trasero) : Trasera Posicion : Inferior Peso : 0.169 kg / 0.373 lb	Part of 4871006040, Part of 4871006120 Part of 4873007020, Part of 4873007040 Part of 4873033110

**CAMRY V XV70 2018 - 2024**

Imagen	Clave del Producto y Descripción	Detalles	OEM
	<b>TO9013</b> Horquilla & Tijera	Peso : 0,862 kg / 1.900 lb Tipo de Material : Tubo De Acero	4871047010

**CELICA T23 1999 - 2005**

Imagen	Clave del Producto y Descripción	Detalles	OEM
	<b>TO6103</b> Horquilla & Tijera	Peso : 4,101 kg / 9.041 lb Tipo de Material : Chapa Metálica	19205303, 4806813010 4806820390, 88970142
	<b>TO6104</b> Horquilla & Tijera	Peso : 4,101 kg / 9.041 lb Tipo de Material : Chapa Metálica	19205304, 4806913010 4806920390, 88970143

**CH-R X1 HYBRID 2016 - 2023**

Imagen	Clave del Producto y Descripción	Detalles	OEM
	<b>TO3035</b> Terminal interior	Peso : 0,639 kg / 1.409 lb Longitud : 279,5 mm / 11.00 inch	45510F4010
	<b>TO9013</b> Horquilla & Tijera	Peso : 0,862 kg / 1.900 lb Tipo de Material : Tubo De Acero	4871047010
	<b>TO11045</b> Buje De Horquilla & Tijera	Chasis (Delantero / Trasero) : Trasera Posicion : Peso : 0,194 kg / 0.428 lb	PART OF 48770-F4010, PART OF 48790-F4010

**COROLLA US E120 2003 - 2008**







Imagen	Clave del Producto y Descripción	Detalles	OEM
	<b>TO6101</b> Horquilla & Tijera	Peso : 3.966 kg / 8.744 lb Tipo de Material : Chapa Metálica	4806802021, 4806802190
	<b>TO6101J</b> Horquilla & Tijera	Peso : 3.256 kg / 7.178 lb Tipo de Material : Chapa Metálica	4806802021, 4806802190
	<b>TO6102</b> Horquilla & Tijera	Peso : 3.966 kg / 8.744 lb Tipo de Material : Chapa Metálica	4806902021, 4806902190
	<b>TO6102J</b> Horquilla & Tijera	Peso : 3.256 kg / 7.178 lb Tipo de Material : Chapa Metálica	4806902021, 4806902190

**COROLLA US E140 2009 - 2013**

Imagen	Clave del Producto y Descripción	Detalles	OEM
	<b>TO1054</b> Rotula	Peso : 0,726 kg / 1.601 lb	43330-09670
	<b>TO2089</b> Terminal Exterior	Peso : 0,416 kg / 0.917 lb Longitud : 100 mm / 3.94 inch	45046-09600

\* Nombres de los vehículos, marcas, modelos, símbolos y logos, número OE y otros números de terceros en el sitio web y catálogo solo son con fines de referencia.

**COROLLA US**
**E140**
**2009 - 2013**

Imagen	Clave del Producto y Descripción	Detalles	OEM
	<b>TO2090</b> Terminal Exterior	Peso : 0,644 kg / 1.420 lb Longitud : 175 mm / 6.89 inch	45046-09610, 45046-19425
	<b>TO6101</b> Horquilla & Tijera	Peso : 3.966 kg / 8.744 lb Tipo de Material : Chapa Metálica	4806802021, 4806802190
	<b>TO6101J</b> Horquilla & Tijera	Peso : 3.256 kg / 7.178 lb Tipo de Material : Chapa Metálica	4806802021, 4806802190
	<b>TO6102</b> Horquilla & Tijera	Peso : 3.966 kg / 8.744 lb Tipo de Material : Chapa Metálica	4806902021, 4806902190
	<b>TO6102J</b> Horquilla & Tijera	Peso : 3.256 kg / 7.178 lb Tipo de Material : Chapa Metálica	4806902021, 4806902190
	<b>TO6103</b> Horquilla & Tijera	Peso : 4,101 kg / 9.041 lb Tipo de Material : Chapa Metálica	19205303, 4806813010 4806820390, 88970142
	<b>TO6104</b> Horquilla & Tijera	Peso : 4,101 kg / 9.041 lb Tipo de Material : Chapa Metálica	19205304, 4806913010 4806920390, 88970143

**COROLLA US**
**E170**
**2013 - 2018**

Imagen	Clave del Producto y Descripción	Detalles	OEM
	<b>TO1054</b> Rotula	Peso : 0,726 kg / 1.601 lb	43330-09670

**CROWN**
**S17**
**1999 - 2007**

Imagen	Clave del Producto y Descripción	Detalles	OEM
	<b>LX3003</b> Terminal interior	Peso : 0,504 kg / 1.111 lb Longitud : 222,5 mm / 8.76 inch	4550339155

\* Nombres de los vehículos, marcas, modelos, símbolos y logos, número OE y otros números de terceros en el sitio web y catálogo solo son con fines de referencia.

**CROWN S18 2003 - 2008**

Imagen	Clave del Producto y Descripción	Detalles	OEM
	<b>LX1003</b> Rotula	Peso : 0,689 kg / 1.519 lb	4333039635

**CROWN S20 2008 - 2012**

Imagen	Clave del Producto y Descripción	Detalles	OEM
	<b>LX1003</b> Rotula	Peso : 0,689 kg / 1.519 lb	4333039635

**CROWN S21 2012 - 2018**

Imagen	Clave del Producto y Descripción	Detalles	OEM
	<b>LX1003</b> Rotula	Peso : 0,689 kg / 1.519 lb	4333039635

**FJ CRUISER GSJ1 2007 - 2014**

Imagen	Clave del Producto y Descripción	Detalles	OEM
	<b>TO1057</b> Rotula	Peso : 0,663 kg / 1.462 lb	4806860040*, 4806960040*

**GT86 2012 - -**

Imagen	Clave del Producto y Descripción	Detalles	OEM
	<b>SU1007</b> Rotula	Peso : 0,260 kg / 0.573 lb	20202-CA010*, 20206-CA000* SU00300358
	<b>SU3011</b> Terminal interior	Peso : 0,476 kg / 1.049 lb Longitud : 226.5 mm / 8.92 inch	34160CA000, SU00300832



**HIACE V 2006 - 2019**

Imagen	Clave del Producto y Descripción	Detalles	OEM
	<b>TO1058</b> Rotula	Peso : 1,235 kg / 2.723 lb	4333029565
	<b>TO2093</b> Terminal Exterior	Peso : 0,508 kg / 1.120 lb Longitud : 123,5 mm / 4.86 inch	4504629456

**HIGHLANDER U2 2000 - 2007**

Imagen	Clave del Producto y Descripción	Detalles	OEM
	<b>TO4076</b> Tornillo Estabilizador	Peso : 0,306 kg / 0.675 lb Tipo de Material : Metal Longitud : 250 mm / 9.84 inch	48830-32040

**HIGHLANDER U4 2008 - 2013**

Imagen	Clave del Producto y Descripción	Detalles	OEM
	<b>TO6079J</b> Horquilla & Tijera	Peso : 3.82 kg / 8.422 lb Tipo de Material : Chapa Metálica	48068-0T011
	<b>TO6080J</b> Horquilla & Tijera	Peso : 3.82 kg / 8.422 lb Tipo de Material : Chapa Metálica	48069-0T011

**HIGHLANDER U5 2014 - 2019**

Imagen	Clave del Producto y Descripción	Detalles	OEM
	<b>TO6079J</b> Horquilla & Tijera	Peso : 3.82 kg / 8.422 lb Tipo de Material : Chapa Metálica	48068-0T011
	<b>TO6080J</b> Horquilla & Tijera	Peso : 3.82 kg / 8.422 lb Tipo de Material : Chapa Metálica	48069-0T011



**HILUX II PICK-UP 2WD 1983 - 2005**

Imagen	Clave del Producto y Descripción	Detalles	OEM
	<b>TO4082</b> Tornillo Estabilizador	Peso : 0,287 kg / 0.633 lb Longitud : 150 mm / 5.91 inch	4882035010



**HILUX II PICK-UP 4WD 1983 - 2005**

Imagen	Clave del Producto y Descripción	Detalles	OEM
	<b>TO1056</b> Rotula	Peso : 0,904 kg / 1.993 lb	43330-39265, 43340-39245

**HILUX IV 2016 -**

Imagen	Clave del Producto y Descripción	Detalles	OEM
	<b>TO6097</b> Horquilla & Tijera	Peso : 7,608 kg / 16.773 lb Tipo de Material : Chapa Metálica	480680K090
	<b>TO6098</b> Horquilla & Tijera	Peso : 7,608 kg / 16.773 lb Tipo de Material : Chapa Metálica	480690K090

**KLUGER U4 2008 - 2013**

Imagen	Clave del Producto y Descripción	Detalles	OEM
	<b>TO6079J</b> Horquilla & Tijera	Peso : 3.82 kg / 8.422 lb Tipo de Material : Chapa Metálica	48068-0T011
	<b>TO6080J</b> Horquilla & Tijera	Peso : 3.82 kg / 8.422 lb Tipo de Material : Chapa Metálica	48069-0T011

**KLUGER U5 2014 -**

Imagen	Clave del Producto y Descripción	Detalles	OEM
	<b>TO6079J</b> Horquilla & Tijera	Peso : 3.82 kg / 8.422 lb Tipo de Material : Chapa Metálica	48068-0T011

\* Nombres de los vehículos, marcas, modelos, símbolos y logos, número OE y otros números de terceros en el sitio web y catálogo solo son con fines de referencia.

**KLUGER U5 2014 -**

Imagen	Clave del Producto y Descripción	Detalles	OEM
	<b>TO6080J</b> Horquilla & Tijera	Peso : 3.82 kg / 8.422 lb Tipo de Material : Chapa Metálica	48069-0T011

**LAND CRUISER 100 J1 1998 - 2007**

Imagen	Clave del Producto y Descripción	Detalles	OEM
	<b>TO4078</b> Tornillo Estabilizador	Peso : 0,221 kg / 0.487 lb Longitud : 128,2 mm / 5.05 inch	4880260090

**LAND CRUISER 200 J2 2008 - 2022**

Imagen	Clave del Producto y Descripción	Detalles	OEM
	<b>TO4074</b> Tornillo Estabilizador	Peso : 0,618 kg / 1.362 lb Tipo de Material : Metal Longitud : 95 mm / 3.74 inch	48820-60070, 48820-60071
	<b>TO4075</b> Tornillo Estabilizador	Peso : 0,618 kg / 1.362 lb Tipo de Material : Metal Longitud : 95 mm / 3.74 inch	48810-60050, 48810-60051

**LAND CRUISER 90 J9 1996 - 2002**

Imagen	Clave del Producto y Descripción	Detalles	OEM
	<b>TO4081</b> Tornillo Estabilizador	Peso : 0,292 kg / 0.644 lb Longitud : 153,5 mm / 6.04 inch	4883035020

**LAND CRUISER J15 2010 -**

Imagen	Clave del Producto y Descripción	Detalles	OEM
	<b>TO1057</b> Rotula	Peso : 0,663 kg / 1.462 lb	4806860040*, 4806960040*

**LAND CRUISER J7 1984 -**

Imagen	Clave del Producto y Descripción	Detalles	OEM
	<b>TO4079</b> Tornillo Estabilizador	Peso : 0,359 kg / 0.791 lb Longitud : 94 mm / 3.70 inch	4882060010
	<b>TO4080</b> Tornillo Estabilizador	Peso : 0,359 kg / 0.791 lb Longitud : 94 mm / 3.70 inch	4881060010

**LAND CRUISER PRADO J150 2010 - 2023**

Imagen	Clave del Producto y Descripción	Detalles	OEM
	<b>TO1057</b> Rotula	Peso : 0,663 kg / 1.462 lb	4806860040*, 4806960040*

**MARK XI 2004 - 2009**

Imagen	Clave del Producto y Descripción	Detalles	OEM
	<b>LX1003</b> Rotula	Peso : 0,689 kg / 1.519 lb	4333039635

**MARK X II 2009 - 2019**

Imagen	Clave del Producto y Descripción	Detalles	OEM
	<b>LX1003</b> Rotula	Peso : 0,689 kg / 1.519 lb	4333039635

**MATRIX 2003 - 2008**

Imagen	Clave del Producto y Descripción	Detalles	OEM
	<b>TO6103</b> Horquilla & Tijera	Peso : 4,101 kg / 9.041 lb Tipo de Material : Chapa Metálica	19205303, 4806813010 4806820390, 88970142
	<b>TO6104</b> Horquilla & Tijera	Peso : 4,101 kg / 9.041 lb Tipo de Material : Chapa Metálica	19205304, 4806913010 4806920390, 88970143

\* Nombres de los vehículos, marcas, modelos, símbolos y logos, número OE y otros números de terceros en el sitio web y catálogo solo son con fines de referencia.

**MATRIX**
**2009 - 2013**

Imagen	Clave del Producto y Descripción	Detalles	OEM
	<b>TO1054</b> Rotula	Peso : 0,726 kg / 1.601 lb	43330-09670
	<b>TO2089</b> Terminal Exterior	Peso : 0,416 kg / 0.917 lb Longitud : 100 mm / 3.94 inch	45046-09600



**PRIUS**
**HYBRID XW50**
**2016 - 2022**

Imagen	Clave del Producto y Descripción	Detalles	OEM
	<b>TO9013</b> Horquilla & Tijera	Peso : 0,862 kg / 1.900 lb Tipo de Material : Tubo De Acero	4871047010

**PRIUS**
**XW20**
**2003 - 2009**

Imagen	Clave del Producto y Descripción	Detalles	OEM
	<b>TO3034</b> Terminal interior	Peso : 0,523 kg / 1.153 lb Longitud : 280,5 mm / 11.04 inch Tamaño de la Rosca : M14X1,5 Diámetro de Cuerda del Perno : M14X1,5	4550347030

**PROACE**
**II**
**2016 -**

Imagen	Clave del Producto y Descripción	Detalles	OEM
	<b>CI1008</b> Rotula	Peso : 0,365 kg / 0.805 lb Medida de Cono : Ø18,5 Diámetro de Cuerda del Perno : M14X1,5 Diámetro del Cuerpo de la Rotu : M40X1,5	9818657580
	<b>CI2016</b> Terminal Exterior	Peso : 0,809 kg / 1.784 lb Longitud : 185 mm / 7.28 inch	9820340180, SU001-A7208
	<b>CI2017</b> Terminal Exterior	Peso : 0,809 kg / 1.784 lb Longitud : 185 mm / 7.28 inch	9820340080, SU001-A7207

**RAV 4 III XA30 2005 - 2013**

Imagen	Clave del Producto y Descripción	Detalles	OEM
	<b>TO9011</b> Horquilla & Tijera	Peso : 1,434 kg / 3.161 lb Tipo de Material : Chapa Metálica	4877042040



**RAV 4 IV XA40 2013 - 2018**

Imagen	Clave del Producto y Descripción	Detalles	OEM
	<b>TO9012</b> Horquilla & Tijera	Peso : 1,434 kg / 3.161 lb Tipo de Material : Chapa Metálica	4879042020

**RAV 4 V XA50 2019 -**

Imagen	Clave del Producto y Descripción	Detalles	OEM
	<b>TO11045</b> Buje De Horquilla & Tijera	Chasis (Delantero / Trasero) : Trasera Posicion : Peso : 0,194 kg / 0.428 lb	PART OF 48770-F4010, PART OF 48790-F4010

**SEQUOIA 2001 - 2004**

Imagen	Clave del Producto y Descripción	Detalles	OEM
	<b>TO2091</b> Terminal Exterior	Peso : 0,592 kg / 1.305 lb Longitud : 74 mm / 2.91 inch	4504639395, 4504639465
	<b>TO2092</b> Terminal Exterior	Peso : 0,592 kg / 1.305 lb Longitud : 74 mm / 2.91 inch	4504739235, 4504739295
	<b>TO4077</b> Tornillo Estabilizador	Peso : 0,384 kg / 0.847 lb Tipo de Material : Metal Longitud : 131 mm / 5.16 inch	488300C010

**SEQUOIA 2005 - 2007**

Imagen	Clave del Producto y Descripción	Detalles	OEM
	<b>TO4077</b> Tornillo Estabilizador	Peso : 0,384 kg / 0.847 lb Tipo de Material : Metal Longitud : 131 mm / 5.16 inch	488300C010

\* Nombres de los vehículos, marcas, modelos, símbolos y logos, número OE y otros números de terceros en el sitio web y catálogo solo son con fines de referencia.

**SEQUOIA**
**2005 - 2007**

Imagen	Clave del Producto y Descripción	Detalles	OEM
	<b>TO6099</b> Horquilla & Tijera	Peso : 8,100 kg / 17.857 lb Tipo de Material : Chapa Metálica	4333039825, 4806834040 5071737
	<b>TO6100</b> Horquilla & Tijera	Peso : 8,100 kg / 17.857 lb Tipo de Material : Chapa Metálica	4334039595, 4806934040 5071736



**SEQUOIA**
**2008 - 2017**

Imagen	Clave del Producto y Descripción	Detalles	OEM
	<b>TO6105</b> Horquilla & Tijera	Peso : 11,959 kg / 26.365 lb Tipo de Material : Chapa Metálica	4806809100, 480680C020
	<b>TO6106</b> Horquilla & Tijera	Peso : 11,959 kg / 26.365 lb Tipo de Material : Chapa Metálica	4806909090, 480690C020

**SIENNA**
**XL10**
**1998 - 2003**

Imagen	Clave del Producto y Descripción	Detalles	OEM
	<b>TO20023830</b> Terminales Completas	Peso : 1,050 kg / 2.315 lb Terminal Exterior : TO2002 Terminal Interior : TO3830	

**SIENNA**
**XL20**
**2004 - 2010**

Imagen	Clave del Producto y Descripción	Detalles	OEM
	<b>TO6077J</b> Horquilla & Tijera	Peso : 3,834 kg / 8.453 lb Tipo de Material : Chapa Metálica	48068-08021
	<b>TO6078J</b> Horquilla & Tijera	Peso : 3,834 kg / 8.453 lb Tipo de Material : Chapa Metálica	48069-08021

**SOLARA XV20 1999 - 2003**

Imagen	Clave del Producto y Descripción	Detalles	OEM
	<b>TO20023830</b> Terminales Completas	Peso : 1,050 kg / 2.315 lb Terminal Exterior : TO2002 Terminal Interior : TO3830	
	<b>TO10001</b> Buje De Horquilla & Tijera	Chasis (Delantero / Trasero) : Trasera Posicion : Inferior Peso : 0.169 kg / 0.373 lb	Part of 4871006040, Part of 4871006120 Part of 4873007020, Part of 4873007040 Part of 4873033110

**T100 1992 - 1998**

Imagen	Clave del Producto y Descripción	Detalles	OEM
	<b>TO1056</b> Rotula	Peso : 0,904 kg / 1.993 lb	43330-39265, 43340-39245

**TACOMA II 2005 - 2015**

Imagen	Clave del Producto y Descripción	Detalles	OEM
	<b>TO2094</b> Terminal Exterior	Peso : 0,328 kg / 0.723 lb Longitud : 84 mm / 3.31 inch	4504609330

**TUNDRA 2000 - 2003**

Imagen	Clave del Producto y Descripción	Detalles	OEM
	<b>TO2091</b> Terminal Exterior	Peso : 0,592 kg / 1.305 lb Longitud : 74 mm / 2.91 inch	4504639395, 4504639465
	<b>TO2092</b> Terminal Exterior	Peso : 0,592 kg / 1.305 lb Longitud : 74 mm / 2.91 inch	4504739235, 4504739295

**TUNDRA 2004 - 2006**



Imagen	Clave del Producto y Descripción	Detalles	OEM
	<b>TO6099</b> Horquilla & Tijera	Peso : 8,100 kg / 17.857 lb Tipo de Material : Chapa Metálica	4333039825, 4806834040 5071737

\* Nombres de los vehículos, marcas, modelos, símbolos y logos, número OE y otros números de terceros en el sitio web y catálogo solo son con fines de referencia.

**TUNDRA**
**2004 - 2006**

Imagen	Clave del Producto y Descripción	Detalles	OEM
	<b>TO6100</b> Horquilla & Tijera	Peso : 8,100 kg / 17.857 lb Tipo de Material : Chapa Metálica	4334039595, 4806934040 5071736



**TUNDRA**
**2007 - 2017**

Imagen	Clave del Producto y Descripción	Detalles	OEM
	<b>TO6105</b> Horquilla & Tijera	Peso : 11,959 kg / 26.365 lb Tipo de Material : Chapa Metálica	4806809100, 480680C020
	<b>TO6106</b> Horquilla & Tijera	Peso : 11,959 kg / 26.365 lb Tipo de Material : Chapa Metálica	4806909090, 480690C020

**VENZA**
**2021 -**

Imagen	Clave del Producto y Descripción	Detalles	OEM
	<b>TO11045</b> Buje De Horquilla & Tijera	Chasis (Delantero / Trasero) : Trasera Posicion : Peso : 0,194 kg / 0.428 lb	PART OF 48770-F4010, PART OF 48790-F4010

**VENZA**
**V1**
**2009 - 2015**

Imagen	Clave del Producto y Descripción	Detalles	OEM
	<b>TO6079J</b> Horquilla & Tijera	Peso : 3.82 kg / 8.422 lb Tipo de Material : Chapa Metálica	48068-0T011
	<b>TO6080J</b> Horquilla & Tijera	Peso : 3.82 kg / 8.422 lb Tipo de Material : Chapa Metálica	48069-0T011

**WISH**
**MPV E2**
**2009 - 2017**

Imagen	Clave del Producto y Descripción	Detalles	OEM
	<b>TO6101</b> Horquilla & Tijera	Peso : 3.966 kg / 8.744 lb Tipo de Material : Chapa Metálica	4806802021, 4806802190

\* Nombres de los vehículos, marcas, modelos, símbolos y logos, número OE y otros números de terceros en el sitio web y catálogo solo son con fines de referencia.



**WISH**
**MPV E2**
**2009 - 2017**

Imagen	Clave del Producto y Descripción	Detalles	OEM
	<b>TO6101J</b> Horquilla & Tijera	Peso : 3.256 kg / 7.178 lb Tipo de Material : Chapa Metálica	4806802021, 4806802190
	<b>TO6102</b> Horquilla & Tijera	Peso : 3.966 kg / 8.744 lb Tipo de Material : Chapa Metálica	4806902021, 4806902190
	<b>TO6102J</b> Horquilla & Tijera	Peso : 3.256 kg / 7.178 lb Tipo de Material : Chapa Metálica	4806902021, 4806902190

**RIW<sup>®</sup>**

**VAUXHALL**

**ADAM**
**2014 - 2019**

Imagen	Clave del Producto y Descripción	Detalles	OEM
	<b>VX12011</b> Soporte De Motor	Chasis (Delantero / Trasero) : Delantero Peso : 1,720 kg / 3.792 lb	13130739, 13234039 5684196, 5684205

**ASTRA**
**F**
**1991 - 1998**

Imagen	Clave del Producto y Descripción	Detalles	OEM
	<b>VX12032</b> Soporte De Amortiguador	Chasis (Delantero / Trasero) : Delantero Peso : 0.258 kg / 0.569 lb	312509, 90375348
	<b>VX12001</b> Soporte De Motor	Chasis (Delantero / Trasero) : Delantero Posicion : Izquierdo Peso : 0,590 kg / 1.301 lb	684643, 90372699
	<b>VX12002</b> Soporte De Motor	Chasis (Delantero / Trasero) : Delantero Posicion : Derecha Peso : 0,610 kg / 1.345 lb	684644, 90335498

**ASTRA**
**G**
**1998 - 2005**

Imagen	Clave del Producto y Descripción	Detalles	OEM
	<b>OP3035</b> Terminal interior	Peso : 0,570 kg / 1.257 lb Longitud : 284 mm / 11.18 inch	1603003, 1603644
	<b>VX12031</b> Soporte De Motor	Chasis (Delantero / Trasero) : Delantero Peso : 0,881 kg / 1.942 lb	24459788, 24459817 684535, 90538549

**ASTRA**
**H**
**2004 - 2009**

Imagen	Clave del Producto y Descripción	Detalles	OEM
	<b>OP11024K</b> Buje De Torsion	Posicion : Izquierda Y Derecha Peso : 0.784 kg / 1.728 lb Nota : 2 Pieces	13110418, 13267215 402952, 5402637
	<b>VX12018</b> Soporte De Motor	Peso : 0,950 kg / 2.094 lb	24459797, 5684136

\* Nombres de los vehículos, marcas, modelos, símbolos y logos, número OE y otros números de terceros en el sitio web y catálogo solo son con fines de referencia.

**ASTRA H 2004 - 2009**









Imagen	Clave del Producto y Descripción	Detalles	OEM
	<b>VX12031</b> Soporte De Motor	Chasis (Delantero / Trasero) : Delantero Peso : 0,881 kg / 1.942 lb	24459788, 24459817 684535, 90538549

**ASTRA J 2009 - 2015**

Imagen	Clave del Producto y Descripción	Detalles	OEM
	<b>VX12012</b> Soporte De Motor	Posicion : Derecha Peso : 2,120 kg / 4.674 lb	13347451, 684137 684321, 684435
	<b>VX12013</b> Soporte De Motor	Posicion : Derecha Peso : 1,970 kg / 4.343 lb	13294212, 13347449 684223, 684315 684411
	<b>VX12014</b> Soporte De Motor	Posicion : Derecha Peso : 2,000 kg / 4.409 lb	13248476, 13347450 684135, 684320
	<b>VX12016</b> Soporte De Motor	Posicion : Derecha Peso : 1,655 kg / 3.649 lb	13248549, 682065
	<b>VX12017</b> Soporte De Motor	Posicion : Izquierdo Peso : 1,700 kg / 3.748 lb	13248544, 682050
	<b>VX12023</b> Soporte De Motor	Peso : 1,500 kg / 3.307 lb	13324496, 684300
	<b>VX12024</b> Soporte De Motor	Peso : 1,400 kg / 3.086 lb	13248599, 684215
	<b>VX12025</b> Soporte De Motor	Peso : 0,850 kg / 1.874 lb	13248600, 684216
	<b>VX12030</b> Soporte De Motor	Chasis (Delantero / Trasero) : Delantero Peso : 0,800 kg / 1.764 lb	13248575, 684214

\* Nombres de los vehículos, marcas, modelos, símbolos y logos, número OE y otros números de terceros en el sitio web y catálogo solo son con fines de referencia.

**ASTRA**
**J**
**2009 - 2015**

Imagen	Clave del Producto y Descripción	Detalles	OEM
	<b>VX12033</b> Soporte De Motor	Chasis (Delantero / Trasero) : Delantero Peso : 1,67 kg / 3.682 lb Nota : HYDRAULIC	1387953, 682066
	<b>VX12034</b> Soporte De Motor	Chasis (Delantero / Trasero) : Delantero Peso : 1,878 kg / 4.140 lb Nota : HYDRAULIC	13248550, 682076
	<b>VX12035</b> Soporte De Motor	Chasis (Delantero / Trasero) : Delantero Peso : 1,657 kg / 3.653 lb Nota : HYDRAULIC	13248542, 682047
	<b>VX12036</b> Soporte De Motor	Chasis (Delantero / Trasero) : Delantero Peso : 2,062 kg / 4.546 lb Nota : HYDRAULIC	13248545, 682063
	<b>VX12037</b> Soporte De Motor	Chasis (Delantero / Trasero) : Delantero Peso : 1,905 kg / 4.200 lb Nota : HYDRAULIC	13248548, 682073
	<b>VX12038</b> Soporte De Motor	Chasis (Delantero / Trasero) : Delantero Posicion : Superior Izquierdo Peso : 1,225 kg / 2.701 lb	13337422, 682075
	<b>VX12039</b> Soporte De Motor	Chasis (Delantero / Trasero) : Delantero Posicion : Superior Izquierdo Peso : 1.65 kg / 3.638 lb	13248546, 682064
	<b>VX12040</b> Soporte De Motor	Chasis (Delantero / Trasero) : Delantero Posicion : Superior Izquierdo Peso : 1.9 kg / 4.189 lb	13287957, 682067

**ASTRA**
**K**
**2016 - 2021**



Imagen	Clave del Producto y Descripción	Detalles	OEM
	<b>OP20423031</b> Terminales Completas	Peso : 1,050 kg / 2.315 lb Terminal Exterior : OP2042 Terminal Interior : OP3031	
	<b>OP20433031</b> Terminales Completas	Peso : 1,050 kg / 2.315 lb Terminal Exterior : OP2043 Terminal Interior : OP3031	

\* Nombres de los vehículos, marcas, modelos, símbolos y logos, número OE y otros números de terceros en el sitio web y catálogo solo son con fines de referencia.

**CASCADA W13 2013 - 2019**

Imagen	Clave del Producto y Descripción	Detalles	OEM
	<b>VX12016</b> Soporte De Motor	Posicion : Derecha Peso : 1,655 kg / 3.649 lb	13248549, 682065
	<b>VX12017</b> Soporte De Motor	Posicion : Izquierdo Peso : 1,700 kg / 3.748 lb	13248544, 682050
	<b>VX12025</b> Soporte De Motor	Peso : 0,850 kg / 1.874 lb	13248600, 684216
	<b>VX12030</b> Soporte De Motor	Chasis (Delantero / Trasero) : Delantero Peso : 0,800 kg / 1.764 lb	13248575, 684214
	<b>VX12036</b> Soporte De Motor	Chasis (Delantero / Trasero) : Delantero Peso : 2,062 kg / 4.546 lb Nota : HYDRAULIC	13248545, 682063



**CAVALIER II-III 1988 - 1995**

Imagen	Clave del Producto y Descripción	Detalles	OEM
	<b>VX12001</b> Soporte De Motor	Chasis (Delantero / Trasero) : Delantero Posicion : Izquierdo Peso : 0,590 kg / 1.301 lb	684643, 90372699
	<b>VX12002</b> Soporte De Motor	Chasis (Delantero / Trasero) : Delantero Posicion : Derecha Peso : 0,610 kg / 1.345 lb	684644, 90335498

**COMBO A 1993 - 1997**

Imagen	Clave del Producto y Descripción	Detalles	OEM
	<b>OP13006K</b> Cubre Polvo De Direccion	Peso : 0.098 kg / 0.216 lb	1609121





**COMBO C 2002 - 2011**

Imagen	Clave del Producto y Descripción	Detalles	OEM
	<b>VX12008</b> Soporte De Motor	Posicion : Izquierdo Peso : 2.1 kg / 4.630 lb Nota : HYDRAULIC	24463127, 5684173
	<b>OP13006K</b> Cubre Polvo De Direccion	Peso : 0.098 kg / 0.216 lb	1609121

**CORSA C 2000 - 2006**

Imagen	Clave del Producto y Descripción	Detalles	OEM
	<b>OP13006K</b> Cubre Polvo De Direccion	Peso : 0.098 kg / 0.216 lb	1609121

**CORSA D 2006 - 2014**

Imagen	Clave del Producto y Descripción	Detalles	OEM
	<b>VX12010</b> Soporte De Motor	Peso : 1.4 kg / 3.086 lb	13234038, 5684203
	<b>VX12011</b> Soporte De Motor	Chasis (Delantero / Trasero) : Delantero Peso : 1,720 kg / 3.792 lb	13130739, 13234039 5684196, 5684205
	<b>VX12015</b> Soporte De Motor	Peso : 0,555 kg / 1.224 lb	13130724, 846837
	<b>FI13016K</b> Cubre Polvo De Direccion	Peso : 0.164 kg / 0.362 lb	4066.95, 77363828 77364571

**CORSA E 2014 - 2019**







Imagen	Clave del Producto y Descripción	Detalles	OEM
	<b>FI13016K</b> Cubre Polvo De Direccion	Peso : 0.164 kg / 0.362 lb	4066.95, 77363828 77364571

\* Nombres de los vehiculos, marcas, modelos, simbolos y logos, numero OE y otros numeros de terceros en el sitio web y catalogo solo son con fines de referencia.

**INSIGNIA A 2008 - 2016**

Imagen	Clave del Producto y Descripción	Detalles	OEM
	<b>VX12022</b> Soporte De Motor	Peso : 0,840 kg / 1.852 lb	13227762, 684612 684613, 91050354
	<b>VX12026</b> Soporte De Motor	Peso : 1,470 kg / 3.241 lb	13112029, 5684143
	<b>VX12028</b> Soporte De Motor	Chasis (Delantero / Trasero) : Delantero Peso : 0,830 kg / 1.830 lb	13227769, 684616
	<b>VX12029</b> Soporte De Motor	Chasis (Delantero / Trasero) : Delantero Posicion : Inferior Peso : 0,815 kg / 1.797 lb Nota : TRANSMISSION TYPE: M32-6	13227767, 684615

**INSIGNIA B 2017 -**

Imagen	Clave del Producto y Descripción	Detalles	OEM
	<b>OP2051</b> TERMINAL EXTERIOR FRONTAL DERECHO	Peso : 0,828 kg / 1.825 lb Longitud : 112 mm / 4.41 inch	23449523
	<b>OP2052</b> TERMINAL EXTERIOR FRONTAL IZQUIERDO	Peso : 0,828 kg / 1.825 lb Longitud : 112 mm / 4.41 inch	23449522
	<b>OP3034</b> Terminal interior	Peso : 0,564 kg / 1.243 lb Longitud : 244 mm / 9.61 inch Tamaño de la Rosca : M16X1,5 Diámetro de Cuerda del Perno : M14X1,5	23449526
	<b>OP4031</b> Tornillo Estabilizador	Peso : 0,394 kg / 0.869 lb Tipo de Material : Metal Longitud : 274 mm / 10.79 inch	23322794, 84077103
	<b>OP4032</b> Tornillo Estabilizador	Peso : 0,394 kg / 0.869 lb Tipo de Material : Metal Longitud : 274 mm / 10.79 inch	23322795, 84077102
	<b>OP4033</b> Tornillo Estabilizador	Peso : 0.276 kg / 0.608 lb Longitud : 100 mm / 3.94 inch Nota : FWD	23384634



\* Nombres de los vehículos, marcas, modelos, símbolos y logos, número OE y otros números de terceros en el sitio web y catálogo solo son con fines de referencia.



**INSIGNIA B 2017 -**

Imagen	Clave del Producto y Descripción	Detalles	OEM
	<b>OP11057</b> Buje De Horquilla & Tijera	Chasis (Delantero / Trasero) : Delantero Posicion : Inferior Grande Peso : 0.69 kg / 1.521 lb	23167662*, 84198829* 84198832*, 84198833*
	<b>OP11058</b> Buje De Horquilla & Tijera	Chasis (Delantero / Trasero) : Delantero Posicion : Inferior Chico Peso : 0.54 kg / 1.190 lb	23167662*, 84198829* 84198832*, 84198833*

**MERIVA A 2003 - 2010**

Imagen	Clave del Producto y Descripción	Detalles	OEM
	<b>VX12008</b> Soporte De Motor	Posicion : Izquierdo Peso : 2.1 kg / 4.630 lb Nota : HYDRAULIC	24463127, 5684173
	<b>VX12009</b> Soporte De Motor	Posicion : Izquierdo Peso : 1,800 kg / 3.968 lb Nota : HYDRAULIC	13181023, 5684186

**MERIVA B 2010 - 2017**

Imagen	Clave del Producto y Descripción	Detalles	OEM
	<b>OP11024K</b> Buje De Torsion	Posicion : Izquierda Y Derecha Peso : 0.784 kg / 1.728 lb Nota : 2 Pieces	13110418, 13267215 402952, 5402637

**MOVANO A 1998 - 2010**

Imagen	Clave del Producto y Descripción	Detalles	OEM
	<b>RN12183</b> Buje De Torsion	Chasis (Delantero / Trasero) : Trasera Posicion : Izquierda Y Derecha Peso : 0,200 kg / 0.441 lb Tipo de Material : Rubber	5000392657
	<b>RN13022K</b> Cubre Polvo De Direccion	Peso : 0.152 kg / 0.335 lb	4501260, 6001547607 6025 370 231, 6025370231 9161560

**NOVA**
**1982 - 1993**

Imagen	Clave del Producto y Descripción	Detalles	OEM
	<b>VX12003</b> Soporte De Amortiguador	Chasis (Delantero / Trasero) : Delantero Peso : 0,920 kg / 2.028 lb	344507, 344522 90445205

**OMEGA**
**A**
**1986 - 1994**

Imagen	Clave del Producto y Descripción	Detalles	OEM
	<b>OP11005K</b> Buje De Horquilla & Tijera	Posicion : Izquierda Y Derecha Peso : 0,277 kg / 0.611 lb Nota : 2 Pieces	352342, 352343 352355, 90288207 90373854

**SENATOR**
**B**
**1986 - 1993**





Imagen	Clave del Producto y Descripción	Detalles	OEM
	<b>OP11005K</b> Buje De Horquilla & Tijera	Posicion : Izquierda Y Derecha Peso : 0,277 kg / 0.611 lb Nota : 2 Pieces	352342, 352343 352355, 90288207 90373854

**SIGNUM**
**2003 - 2008**

Imagen	Clave del Producto y Descripción	Detalles	OEM
	<b>VX12004</b> Soporte De Motor	Peso : 1,302 kg / 2.870 lb	24443128, 5684101
	<b>VX12005</b> Soporte De Motor	Peso : 1,403 kg / 3.093 lb	09156939, 5684086 9156939
	<b>VX12006</b> Soporte De Motor	Peso : 2,070 kg / 4.564 lb Nota : HYDRAULIC	09156946, 5684089 9156946
	<b>VX12007</b> Soporte De Motor	Peso : 1,434 kg / 3.161 lb Nota : HYDRAULIC	09156944, 5684088 9156944
	<b>VX12020</b> Soporte De Motor	Peso : 1,360 kg / 2.998 lb	24443129, 5684102

\* Nombres de los vehículos, marcas, modelos, símbolos y logos, número OE y otros números de terceros en el sitio web y catálogo solo son con fines de referencia.

**SIGNUM**
**2003 - 2008**

Imagen	Clave del Producto y Descripción	Detalles	OEM
	<b>VX12021</b> Soporte De Motor	Posicion : Derecha Peso : 1,900 kg / 4.189 lb	13112022, 5684648
	<b>VX12026</b> Soporte De Motor	Peso : 1,470 kg / 3.241 lb	13112029, 5684143
	<b>VX12027</b> Soporte De Motor	Posicion : Derecha Peso : 1,350 kg / 2.976 lb	13183100, 5684765
	<b>OP13005K</b> Cubre Polvo De Direccion	Peso : 0.106 kg / 0.234 lb	1609132, 77363710

**TIGRA**
**2004 - 2009**

Imagen	Clave del Producto y Descripción	Detalles	OEM
	<b>OP13006K</b> Cubre Polvo De Direccion	Peso : 0.098 kg / 0.216 lb	1609121

**OP8002 / Kit De Suspension Y Direccion**

**VECTRA**

**C**

**2002 - 2008**

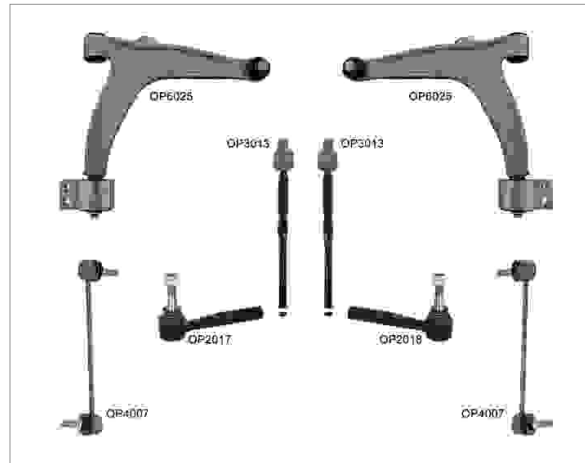



**Piezas del Kit**

Imagen	RIW Codigo / Nombre	OEM	OEM	RIW Codigo / Nombre	Imagen
	<b>OP2017</b> Terminal Exterior Frontal Derecho	1603228, 5235668 5239322, 77363712	12801423, 1603227 5235650, 5239314 77363713	<b>OP2018</b> Terminal Exterior Frontal Izquierdo	
	<b>OP3013</b> Terminal Interior Delantero	1603229, 1603351 1603415, 93172256	24417251, 350603 51741130	<b>OP4007</b> Tornillo Estabilizador Delantero	
	<b>OP6025</b> Horquillas Frontal Derecho Inferior	12796014, 12799200 352052, 51748652	12796013, 12799199 12799200, 352051 51748653	<b>OP6026</b> Horquillas Frontal Inferior Izquierdo	

\* Nombres de los vehiculos, marcas, modelos, simbolos y logos, numero OE y otros numeros de terceros en el sitio web y catalogo solo son con fines de referencia.

**VECTRA**
**C**
**2002 - 2008**

Imagen	Clave del Producto y Descripción	Detalles	OEM
	<b>VX12004</b> Soporte De Motor	Peso : 1,302 kg / 2.870 lb	24443128, 5684101
	<b>VX12005</b> Soporte De Motor	Peso : 1,403 kg / 3.093 lb	09156939, 5684086 9156939
	<b>VX12006</b> Soporte De Motor	Peso : 2,070 kg / 4.564 lb Nota : HYDRAULIC	09156946, 5684089 9156946
	<b>VX12007</b> Soporte De Motor	Peso : 1,434 kg / 3.161 lb Nota : HYDRAULIC	09156944, 5684088 9156944
	<b>VX12020</b> Soporte De Motor	Peso : 1,360 kg / 2.998 lb	24443129, 5684102
	<b>VX12021</b> Soporte De Motor	Posicion : Derecha Peso : 1,900 kg / 4.189 lb	13112022, 5684648
	<b>VX12026</b> Soporte De Motor	Peso : 1,470 kg / 3.241 lb	13112029, 5684143
	<b>OP13005K</b> Cubre Polvo De Direccion	Peso : 0.106 kg / 0.234 lb	1609132, 77363710

**VIVA**
**C16**
**2015 -**

Imagen	Clave del Producto y Descripción	Detalles	OEM
	<b>OP3033</b> Terminal interior	Peso : 0,481 kg / 1.060 lb Longitud : 248 mm / 9.76 inch	1609224, 95371542

**VIVARO A 2001 - 2014**

Imagen	Clave del Producto y Descripción	Detalles	OEM
	<b>RN12167K</b> Goma De Barra Estabilizadora	Posicion : Izquierda Y Derecha Peso : 0.15 kg / 0.331 lb Nota : 2 Pieces	4408905, 4417971 4418991, 4418992 8200048177, 8200629180 8200845492, 91166695 93861802, 93861803
	<b>RN13011K</b> Cubre Polvo De Direccion	Peso : 0.16 kg / 0.353 lb	7701472765, 7701473334

**VIVARO B 2014 - 2019**

Imagen	Clave del Producto y Descripción	Detalles	OEM
	<b>RN12167K</b> Goma De Barra Estabilizadora	Posicion : Izquierda Y Derecha Peso : 0.15 kg / 0.331 lb Nota : 2 Pieces	4408905, 4417971 4418991, 4418992 8200048177, 8200629180 8200845492, 91166695 93861802, 93861803
	<b>RN13011K</b> Cubre Polvo De Direccion	Peso : 0.16 kg / 0.353 lb	7701472765, 7701473334

**ZAFIRA A 1999 - 2005**

Imagen	Clave del Producto y Descripción	Detalles	OEM
	<b>VX12031</b> Soporte De Motor	Chasis (Delantero / Trasero) : Delantero Peso : 0,881 kg / 1.942 lb	24459788, 24459817 684535, 90538549

**ZAFIRA B 2005 - 2011**

Imagen	Clave del Producto y Descripción	Detalles	OEM
	<b>OP11024K</b> Buje De Torsion	Posicion : Izquierda Y Derecha Peso : 0.784 kg / 1.728 lb Nota : 2 Pieces	13110418, 13267215 402952, 5402637
	<b>VX12018</b> Soporte De Motor	Peso : 0,950 kg / 2.094 lb	24459797, 5684136
	<b>VX12019</b> Soporte De Motor	Posicion : Derecha Peso : 0,916 kg / 2.019 lb	13221031, 24459816 5684187

\* Nombres de los vehículos, marcas, modelos, símbolos y logos, número OE y otros números de terceros en el sitio web y catálogo solo son con fines de referencia.

**ZAFIRA**
**C P12**
**2011 -**

Imagen	Clave del Producto y Descripción	Detalles	OEM
	<b>VX12012</b> Soporte De Motor	Posicion : Derecha Peso : 2,120 kg / 4.674 lb	13347451, 684137 684321, 684435
	<b>VX12016</b> Soporte De Motor	Posicion : Derecha Peso : 1,655 kg / 3.649 lb	13248549, 682065
	<b>VX12025</b> Soporte De Motor	Peso : 0,850 kg / 1.874 lb	13248600, 684216
	<b>VX12030</b> Soporte De Motor	Chasis (Delantero / Trasero) : Delantero Peso : 0,800 kg / 1.764 lb	13248575, 684214
	<b>VX12036</b> Soporte De Motor	Chasis (Delantero / Trasero) : Delantero Peso : 2,062 kg / 4.546 lb Nota : HYDRAULIC	13248545, 682063

**RIW®**

**VOLKSWAGEN**



**ARTEON 3H7 2017 -**

Imagen	Clave del Producto y Descripción	Detalles	OEM
	<b>VW9006</b> Horquilla & Tijera	Peso : 1,992 kg / 4.392 lb Tipo de Material : Chapa Metálica	3Q0505224
	<b>VW9007</b> Horquilla & Tijera	Peso : 1,992 kg / 4.392 lb Tipo de Material : Chapa Metálica	3Q0505223
	<b>VW13006K</b> Cubre Polvo De Direccion	Peso : 0.29 kg / 0.639 lb	1K0423831A, 5C0423831

**BEETLE 5C1, 5C2 2011 -**

Imagen	Clave del Producto y Descripción	Detalles	OEM
	<b>VW12159</b> Buje De Eje	Chasis (Delantero / Trasero) : Trasera Posicion : Izquierda Y Derecha Peso : 0,130 kg / 0.287 lb	1K0505553, 1K0505553A
	<b>VW13006K</b> Cubre Polvo De Direccion	Peso : 0.29 kg / 0.639 lb	1K0423831A, 5C0423831

**VW8003 / Kit De Suspensi?n Y Direcci?n**





**BEETLE**

**9C1, 1C1**

**1998 - 2010**



**Piezas del Kit**

Imagen	RIW Codigo / Nombre	OEM	OEM	RIW Codigo / Nombre	Imagen
	<b>AU1014</b> R?tula Frontal Derecho Inferior	1J0407366A, 1J0407366AS 1J0407366B, 1J0407366C 1J0407366D, 1J0407366H	1J0407365A, 1J0407365B 1J0407365C, 1J0407365D	<b>AU1015</b> R?tula Frontal Inferior Izquierdo	
	<b>AU11002</b> Bujes Delantero	1J0407181, 1J0407181A	191407182, 357407182 357407182F	<b>AU11005</b> Bujes Frontal Central	
	<b>VW4011</b> Tornillo Estabilizador Delantero	1J0411315E, 1J0411315G 1J0422315G			

\* Nombres de los vehiculos, marcas, modelos, simbolos y logos, numero OE y otros numeros de terceros en el sitio web y catalogo solo son con fines de referencia.

**BEETLE** **9C1, 1C1** **1998 - 2010**

Imagen	Clave del Producto y Descripción	Detalles	OEM
	<b>VW13002K</b> Cubre Polvo De Direccion	Peso : 0.2 kg / 0.441 lb	1J0422831, 1J0422831B 8N0422831

**VW8003 / Kit De Suspensi?n Y Direcci?n**

**BORA**

**1998 - 2005**



**Piezas del Kit**

Imagen	RIW Codigo / Nombre	OEM	OEM	RIW Codigo / Nombre	Imagen
	<b>AU1014</b> R?tula Frontal Derecho Inferior	1J0407366A, 1J0407366AS 1J0407366B, 1J0407366C 1J0407366D, 1J0407366H	1J0407365A, 1J0407365B 1J0407365C, 1J0407365D	<b>AU1015</b> R?tula Frontal Inferior Izquierdo	
	<b>AU11002</b> Bujes Delantero	1J0407181, 1J0407181A	191407182, 357407182 357407182F	<b>AU11005</b> Bujes Frontal Central	
	<b>VW4011</b> Tornillo Estabilizador Delantero	1J0411315E, 1J0411315G 1J0422315G			

\* Nombres de los vehiculos, marcas, modelos, simbolos y logos, numero OE y otros numeros de terceros en el sitio web y catalogo solo son con fines de referencia.

**BORA** **1998 - 2005**

Imagen	Clave del Producto y Descripción	Detalles	OEM
	<b>VW13002K</b> Cubre Polvo De Direccion	Peso : 0.2 kg / 0.441 lb	1J0422831, 1J0422831B 8N0422831

**CADDY** **2004 - 2020**
**III TYP 2K**

Imagen	Clave del Producto y Descripción	Detalles	OEM
	<b>VW13006K</b> Cubre Polvo De Direccion	Peso : 0.29 kg / 0.639 lb	1K0423831A, 5C0423831

**CC** **2011 - 2016**
**358**

Imagen	Clave del Producto y Descripción	Detalles	OEM
	<b>VW12159</b> Buje De Eje	Chasis (Delantero / Trasero) : Trasera Posicion : Izquierda Y Derecha Peso : 0,130 kg / 0.287 lb	1K0505553, 1K0505553A
	<b>AU12024</b> Buje De Torsion	Chasis (Delantero / Trasero) : Trasera Posicion : Izquierda Y Derecha Peso : 0.557 kg / 1.228 lb	1K0505145F, 1K0505145H 1K0505145K
	<b>VW13006K</b> Cubre Polvo De Direccion	Peso : 0.29 kg / 0.639 lb	1K0423831A, 5C0423831

**CRAFTER** **2016 -**
**SY, SZ**

Imagen	Clave del Producto y Descripción	Detalles	OEM
	<b>VW1041</b> Rotula	Peso : 0,597 kg / 1.316 lb	2N0407361A
	<b>VW4034</b> Tornillo Estabilizador	Peso : 0.58 kg / 1.279 lb	2N0505465A
	<b>VW11078</b> Buje De Tornillo Estabilizador	Chasis (Delantero / Trasero) : Trasera Posicion : Trasera Peso : 0.12 kg / 0.265 lb Longitud : VW4034 mm / 0.00 inch	2N0505465A*

\* Nombres de los vehiculos, marcas, modelos, simbolos y logos, numero OE y otros numeros de terceros en el sitio web y catalogo solo son con fines de referencia.

**CRAFTER SY, SZ 2016 -**

Imagen	Clave del Producto y Descripción	Detalles	OEM
	<b>VW11079</b> Buje De Tornillo Estabilizador	Chasis (Delantero / Trasero) : Trasera Posicion : Trasera Peso : 0.11 kg / 0.243 lb	2N0505465B*

**DERBY II 1994 - 2009**

Imagen	Clave del Producto y Descripción	Detalles	OEM
	<b>VW12068K</b> Buje De Torsion	Chasis (Delantero / Trasero) : Trasera Posicion : Izquierda Y Derecha Peso : 0.332 kg / 0.732 lb	6N0501541, 6N0501541D

**EOS 1F7, 1F8 2006 - 2016**

Imagen	Clave del Producto y Descripción	Detalles	OEM
	<b>VW12159</b> Buje De Eje	Chasis (Delantero / Trasero) : Trasera Posicion : Izquierda Y Derecha Peso : 0,130 kg / 0.287 lb	1K0505553, 1K0505553A
	<b>VW13006K</b> Cubre Polvo De Direccion	Peso : 0.29 kg / 0.639 lb	1K0423831A, 5C0423831



**SK8001 / Kit De Suspension Y Direccion**
**FOX**
**2003 - 2022**

**Piezas del Kit**

Imagen	RIW Codigo / Nombre	OEM	OEM	RIW Codigo / Nombre	Imagen
	<b>AU4001</b> Tornillo Estabilizador Delantero	893407465, 893407465A 8A0407465, 8A0407465B 8A0407465C	5Z0423812, 6Q0419812C 6Q0423812, 6Q0423812A 6Q0423812C, 6Q0423812D 6R0423812, 8Z0423811A	<b>SK2003</b> Terminal Exterior Frontal Derecho	
	<b>SK2004</b> Terminal Exterior Frontal Izquierdo	5Z0423811, 6Q0419811C 6Q0423811, 6Q0423811A 6Q0423811C, 6Q0423811D 6R0423811, 8Z0423812A	6Q0 423 821 B, 6Q0423821B 6X0422803, 6X0422804 6X0422807, 6X0422821	<b>SK3003</b> Terminal Interior Delantero	
	<b>SK6009</b> Horquillas Frontal Derecho Inferior	6N0407151, 6Q0407151D* 6Q0407151D, 6Q0407151E* 6Q0407151E, 6Q0407151L 6Q0407151Z, 6Q0407366A*	6N040711, 6Q0407151D* 6Q0407151D, 6Q0407151E* 6Q0407151E, 6Q0407151L 6Q0407151Z, 6Q0407365A*	<b>SK6010</b> Horquillas Frontal Inferior Izquierdo	

**VW8003 / Kit De Suspensi?n Y Direccion**

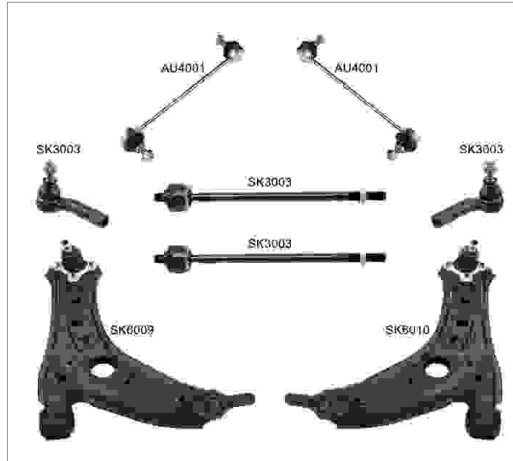
**GOLF**

**IV MK4, A4**

**1998 - 2003**



**Piezas del Kit**

Imagen	RIW Codigo / Nombre	OEM	OEM	RIW Codigo / Nombre	Imagen
	<b>AU1014</b> R?tula Frontal Derecho Inferior	1J0407366A, 1J0407366AS 1J0407366B, 1J0407366C 1J0407366D, 1J0407366H	1J0407365A, 1J0407365B 1J0407365C, 1J0407365D	<b>AU1015</b> R?tula Frontal Inferior Izquierdo	
	<b>AU11002</b> Bujes Delantero	1J0407181, 1J0407181A	191407182, 357407182 357407182F	<b>AU11005</b> Bujes Frontal Central	
	<b>VW4011</b> Tornillo Estabilizador Delantero	1J0411315E, 1J0411315G 1J0422315G			

\* Nombres de los vehiculos, marcas, modelos, simbolos y logos, numero OE y otros numeros de terceros en el sitio web y catalogo solo son con fines de referencia.



**GOLF IV MK4, A4 1998 - 2003**

Imagen	Clave del Producto y Descripción	Detalles	OEM
	<b>VW13002K</b> Cubre Polvo De Direccion	Peso : 0.2 kg / 0.441 lb	1J0422831, 1J0422831B 8N0422831

**GOLF V MK5, A5 2003 - 2009**

Imagen	Clave del Producto y Descripción	Detalles	OEM
	<b>VW12159</b> Buje De Eje	Chasis (Delantero / Trasero) : Trasera Posicion : Izquierda Y Derecha Peso : 0,130 kg / 0.287 lb	1K0505553, 1K0505553A
	<b>AU12024</b> Buje De Torsion	Chasis (Delantero / Trasero) : Trasera Posicion : Izquierda Y Derecha Peso : 0.557 kg / 1.228 lb	1K0505145F, 1K0505145H 1K0505145K
	<b>VW13006K</b> Cubre Polvo De Direccion	Peso : 0.29 kg / 0.639 lb	1K0423831A, 5C0423831

**GOLF VI MK6, A6 2009 - 2012**

Imagen	Clave del Producto y Descripción	Detalles	OEM
	<b>VW12159</b> Buje De Eje	Chasis (Delantero / Trasero) : Trasera Posicion : Izquierda Y Derecha Peso : 0,130 kg / 0.287 lb	1K0505553, 1K0505553A
	<b>AU12024</b> Buje De Torsion	Chasis (Delantero / Trasero) : Trasera Posicion : Izquierda Y Derecha Peso : 0.557 kg / 1.228 lb	1K0505145F, 1K0505145H 1K0505145K
	<b>VW13006K</b> Cubre Polvo De Direccion	Peso : 0.29 kg / 0.639 lb	1K0423831A, 5C0423831

**GOLF VII MK7, MQB 2012 - 2020**

Imagen	Clave del Producto y Descripción	Detalles	OEM
	<b>AU11070</b> Buje De Horquilla & Tijera	Chasis (Delantero / Trasero) : Trasera Posicion : Inferior Peso : 0,100 kg / 0.220 lb	5Q0505171, 5Q0505311C 5Q0505311CSK, 5Q0505311D 5Q0505311DSK

\* Nombres de los vehiculos, marcas, modelos, simbolos y logos, numero OE y otros numeros de terceros en el sitio web y catalogo solo son con fines de referencia.

**GOLF VII MK7, MQB 2012 - 2020**

Imagen	Clave del Producto y Descripción	Detalles	OEM
	<b>VW12159</b> Buje De Eje	Chasis (Delantero / Trasero) : Trasera Posicion : Izquierda Y Derecha Peso : 0,130 kg / 0.287 lb	1K0505553, 1K0505553A
	<b>VW13006K</b> Cubre Polvo De Direccion	Peso : 0.29 kg / 0.639 lb	1K0423831A, 5C0423831

**GTI MK5, A5 2006 - 2009**

Imagen	Clave del Producto y Descripción	Detalles	OEM
	<b>VW13006K</b> Cubre Polvo De Direccion	Peso : 0.29 kg / 0.639 lb	1K0423831A, 5C0423831

**VW8003 / Kit De Suspensi?n Y Direccion**

**JETTA**

**MK4, A4**

**1999 - 2004**



**Piezas del Kit**

Imagen	RIW Codigo / Nombre	OEM	OEM	RIW Codigo / Nombre	Imagen
	<b>AU1014</b> R?tula Frontal Derecho Inferior	1J0407366A, 1J0407366AS 1J0407366B, 1J0407366C 1J0407366D, 1J0407366H	1J0407365A, 1J0407365B 1J0407365C, 1J0407365D	<b>AU1015</b> R?tula Frontal Inferior Izquierdo	
	<b>AU11002</b> Bujes Delantero	1J0407181, 1J0407181A	191407182, 357407182 357407182F	<b>AU11005</b> Bujes Frontal Central	
	<b>VW4011</b> Tornillo Estabilizador Delantero	1J0411315E, 1J0411315G 1J0422315G			

\* Nombres de los vehiculos, marcas, modelos, simbolos y logos, numero OE y otros numeros de terceros en el sitio web y catalogo solo son con fines de referencia.

**JETTA MK5, A5 III 1K2 2005 - 2010**

Imagen	Clave del Producto y Descripción	Detalles	OEM
	<b>VW12159</b> Buje De Eje	Chasis (Delantero / Trasero) : Trasera Posicion : Izquierda Y Derecha Peso : 0,130 kg / 0.287 lb	1K0505553, 1K0505553A
	<b>VW13006K</b> Cubre Polvo De Direccion	Peso : 0.29 kg / 0.639 lb	1K0423831A, 5C0423831

**JETTA MK6, A6 IV 162 2010 - 2017**

Imagen	Clave del Producto y Descripción	Detalles	OEM
	<b>VW12159</b> Buje De Eje	Chasis (Delantero / Trasero) : Trasera Posicion : Izquierda Y Derecha Peso : 0,130 kg / 0.287 lb	1K0505553, 1K0505553A
	<b>VW13006K</b> Cubre Polvo De Direccion	Peso : 0.29 kg / 0.639 lb	1K0423831A, 5C0423831

**LT II 1996 - 2006**

Imagen	Clave del Producto y Descripción	Detalles	OEM
	<b>ME12060</b> Goma De Barra Estabilizadora	Chasis (Delantero / Trasero) : Trasera Peso : 0.1 kg / 0.220 lb Tipo de Material : Rubber	2D0511413, 6013210350
	<b>ME12060K</b> Goma De Barra Estabilizadora	Chasis (Delantero / Trasero) : Trasera Peso : 0.2 kg / 0.441 lb Tipo de Material : Rubber Nota : 2 Pieces	2D0511413, 6013210350

**LUPO 6X1, 6E1 1998 - 2005**

Imagen	Clave del Producto y Descripción	Detalles	OEM
	<b>VW12068K</b> Buje De Torsion	Chasis (Delantero / Trasero) : Trasera Posicion : Izquierda Y Derecha Peso : 0.332 kg / 0.732 lb	6N0501541, 6N0501541D

**MULTIVAN V 7HM, 7HN, 7HF, 7EF, 7EM, 7E 2003 - 2015**

Imagen	Clave del Producto y Descripción	Detalles	OEM
	<b>VW1030K</b> Rotula	Peso : 0,600 kg / 1.323 lb Medida de Cono : Ø18,3 Diámetro del Horificio de Cono : Ø13 Diámetro de Cuerda del Perno : M14X1,5	7H8407361, 7H8407361A
	<b>VW6061</b> Horquilla & Tijera	Peso : 8,026 kg / 17.694 lb Tipo de Material : Döküm Çelik	7E0407152B
	<b>VW6062</b> Horquilla & Tijera	Peso : 8,026 kg / 17.694 lb Tipo de Material : Döküm Çelik	7E0407151C

**PASSAT B3 1988 - 1994**

Imagen	Clave del Producto y Descripción	Detalles	OEM
	<b>VW12011K</b> Buje De Puente	Chasis (Delantero / Trasero) : Trasera Posicion : Izquierda Y Derecha Peso : 0.536 kg / 1.182 lb	333501541, 357501541 357501541A, 3A0501541

**PASSAT B4 1994 - 1997**

Imagen	Clave del Producto y Descripción	Detalles	OEM
	<b>VW12011K</b> Buje De Puente	Chasis (Delantero / Trasero) : Trasera Posicion : Izquierda Y Derecha Peso : 0.536 kg / 1.182 lb	333501541, 357501541 357501541A, 3A0501541

**PASSAT B6 2005 - 2010**

Imagen	Clave del Producto y Descripción	Detalles	OEM
	<b>VW12159</b> Buje De Eje	Chasis (Delantero / Trasero) : Trasera Posicion : Izquierda Y Derecha Peso : 0,130 kg / 0.287 lb	1K0505553, 1K0505553A
	<b>AU12024</b> Buje De Torsion	Chasis (Delantero / Trasero) : Trasera Posicion : Izquierda Y Derecha Peso : 0.557 kg / 1.228 lb	1K0505145F, 1K0505145H 1K0505145K
	<b>VW13006K</b> Cubre Polvo De Direccion	Peso : 0.29 kg / 0.639 lb	1K0423831A, 5C0423831

\* Nombres de los vehiculos, marcas, modelos, simbolos y logos, numero OE y otros numeros de terceros en el sitio web y catalogo solo son con fines de referencia.

**PASSAT B7 2010 - 2014**

Imagen	Clave del Producto y Descripción	Detalles	OEM
	<b>VW12159</b> Buje De Eje	Chasis (Delantero / Trasero) : Trasera Posicion : Izquierda Y Derecha Peso : 0,130 kg / 0.287 lb	1K0505553, 1K0505553A
	<b>AU12024</b> Buje De Torsion	Chasis (Delantero / Trasero) : Trasera Posicion : Izquierda Y Derecha Peso : 0.557 kg / 1.228 lb	1K0505145F, 1K0505145H 1K0505145K
	<b>VW13006K</b> Cubre Polvo De Direccion	Peso : 0.29 kg / 0.639 lb	1K0423831A, 5C0423831

**PASSAT B8 2015 - 2023**

Imagen	Clave del Producto y Descripción	Detalles	OEM
	<b>VW9006</b> Horquilla & Tijera	Peso : 1,992 kg / 4.392 lb Tipo de Material : Chapa Metálica	3Q0505224
	<b>VW9007</b> Horquilla & Tijera	Peso : 1,992 kg / 4.392 lb Tipo de Material : Chapa Metálica	3Q0505223
	<b>VW13006K</b> Cubre Polvo De Direccion	Peso : 0.29 kg / 0.639 lb	1K0423831A, 5C0423831

**POLO III 6N1 1994 - 2001**

Imagen	Clave del Producto y Descripción	Detalles	OEM
	<b>VW12068K</b> Buje De Torsion	Chasis (Delantero / Trasero) : Trasera Posicion : Izquierda Y Derecha Peso : 0.332 kg / 0.732 lb	6N0501541, 6N0501541D









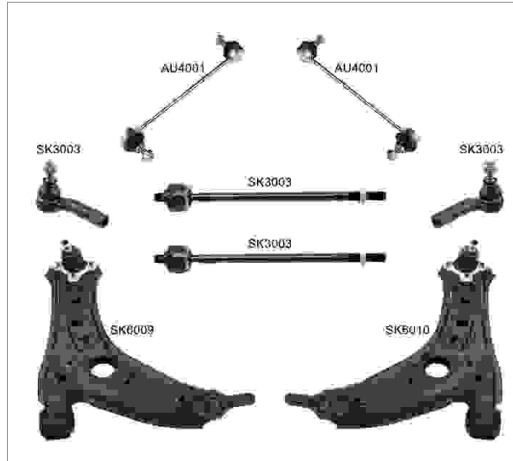

**SK8001 / Kit De Suspension Y Direccion**
**POLO**
**IV 9N**
**2001 - 2009**

**Piezas del Kit**

Imagen	RIWCodigo / Nombre	OEM	OEM	RIWCodigo / Nombre	Imagen
	<b>AU4001</b> Tornillo Estabilizador Delantero	893407465, 893407465A 8A0407465, 8A0407465B 8A0407465C	5Z0423812, 6Q0419812C 6Q0423812, 6Q0423812A 6Q0423812C, 6Q0423812D 6R0423812, 8Z0423811A	<b>SK2003</b> Terminal Exterior Frontal Derecho	
	<b>SK2004</b> Terminal Exterior Frontal Izquierdo	5Z0423811, 6Q0419811C 6Q0423811, 6Q0423811A 6Q0423811C, 6Q0423811D 6R0423811, 8Z0423812A	6Q0 423 821 B, 6Q0423821B 6X0422803, 6X0422804 6X0422807, 6X0422821	<b>SK3003</b> Terminal Interior Delantero	
	<b>SK6009</b> Horquillas Frontal Derecho Inferior	6N0407151, 6Q0407151D* 6Q0407151D, 6Q0407151E* 6Q0407151E, 6Q0407151L 6Q0407151Z, 6Q0407366A*	6N040711, 6Q0407151D* 6Q0407151D, 6Q0407151E* 6Q0407151E, 6Q0407151L 6Q0407151Z, 6Q0407365A*	<b>SK6010</b> Horquillas Frontal Inferior Izquierdo	

POLO		VI		2017 -
Imagen	Clave del Producto y Descripción	Detalles	OEM	
	<b>VW3025</b> Terminal interior	Peso : 0,676 kg / 1.490 lb Longitud : 311 mm / 12.24 inch Tamaño de la Rosca : M14X1,5 Diámetro de Cuerda del Perno : M16X1,5	2Q0423810D	
	<b>VW6063</b> Horquilla & Tijera	Peso : 3,004 kg / 6.623 lb Tipo de Material : Chapa Metálica	2Q0407152B	
	<b>VW6063J</b> Horquilla & Tijera	Peso : 2,439 kg / 5.377 lb Tipo de Material : Chapa Metálica	2Q0407152B	
	<b>VW6064</b> Horquilla & Tijera	Peso : 3,004 kg / 6.623 lb Tipo de Material : Chapa Metálica	2Q0407151B	
	<b>VW6064J</b> Horquilla & Tijera	Peso : 2,439 kg / 5.377 lb Tipo de Material : Chapa Metálica	2Q0407151B	
	<b>VW6065</b> Horquilla & Tijera	Peso : 3,57 kg / 7.871 lb Tipo de Material : Chapa Metálica	2Q0407152C	
	<b>VW6065J</b> Horquilla & Tijera	Peso : 2,964 kg / 6.535 lb Tipo de Material : Chapa Metálica	2Q0407152C	
	<b>VW6066</b> Horquilla & Tijera	Peso : 3,57 kg / 7.871 lb Tipo de Material : Chapa Metálica	2Q0407151C	
	<b>VW6066J</b> Horquilla & Tijera	Peso : 2,964 kg / 6.535 lb Tipo de Material : Chapa Metálica	2Q0407151C	

**SCIROCCO** **III 137** **2008 - 2017**

Imagen	Clave del Producto y Descripción	Detalles	OEM
	<b>VW12159</b> Buje De Eje	Chasis (Delantero / Trasero) : Trasera Posicion : Izquierda Y Derecha Peso : 0,130 kg / 0.287 lb	1K0505553, 1K0505553A

\* Nombres de los vehículos, marcas, modelos, símbolos y logos, número OE y otros números de terceros en el sitio web y catálogo solo son con fines de referencia.



**SCIROCCO**
**III 137**
**2008 - 2017**

Imagen	Clave del Producto y Descripción	Detalles	OEM
	<b>VW13006K</b> Cubre Polvo De Direccion	Peso : 0.29 kg / 0.639 lb	1K0423831A, 5C0423831

**SHARAN**
**7N1, 7N2**
**2010 - 2022**

Imagen	Clave del Producto y Descripción	Detalles	OEM
	<b>VW12159</b> Buje De Eje	Chasis (Delantero / Trasero) : Trasera Posicion : Izquierda Y Derecha Peso : 0,130 kg / 0.287 lb	1K0505553, 1K0505553A
	<b>AU12024</b> Buje De Torsion	Chasis (Delantero / Trasero) : Trasera Posicion : Izquierda Y Derecha Peso : 0.557 kg / 1.228 lb	1K0505145F, 1K0505145H 1K0505145K
	<b>VW13006K</b> Cubre Polvo De Direccion	Peso : 0.29 kg / 0.639 lb	1K0423831A, 5C0423831

**T-CROSS**
**C11**
**2019 -**

Imagen	Clave del Producto y Descripción	Detalles	OEM
	<b>VW3025</b> Terminal interior	Peso : 0,676 kg / 1.490 lb Longitud : 311 mm / 12.24 inch Tamaño de la Rosca : M14X1,5 Diámetro de Cuerda del Perno : M16X1,5	2Q0423810D
	<b>VW6063</b> Horquilla & Tijera	Peso : 3,004 kg / 6.623 lb Tipo de Material : Chapa Metálica	2Q0407152B
	<b>VW6063J</b> Horquilla & Tijera	Peso : 2,439 kg / 5.377 lb Tipo de Material : Chapa Metálica	2Q0407152B
	<b>VW6064</b> Horquilla & Tijera	Peso : 3,004 kg / 6.623 lb Tipo de Material : Chapa Metálica	2Q0407151B
	<b>VW6064J</b> Horquilla & Tijera	Peso : 2,439 kg / 5.377 lb Tipo de Material : Chapa Metálica	2Q0407151B

\* Nombres de los vehículos, marcas, modelos, símbolos y logos, número OE y otros números de terceros en el sitio web y catálogo solo son con fines de referencia.

**TIGUAN I 5N 2007 - 2016**

Imagen	Clave del Producto y Descripción	Detalles	OEM
	<b>VW12159</b> Buje De Eje	Chasis (Delantero / Trasero) : Trasera Posicion : Izquierda Y Derecha Peso : 0,130 kg / 0.287 lb	1K0505553, 1K0505553A
	<b>AU12024</b> Buje De Torsion	Chasis (Delantero / Trasero) : Trasera Posicion : Izquierda Y Derecha Peso : 0.557 kg / 1.228 lb	1K0505145F, 1K0505145H 1K0505145K
	<b>VW13006K</b> Cubre Polvo De Direccion	Peso : 0.29 kg / 0.639 lb	1K0423831A, 5C0423831

**TIGUAN II AD1 2016 - 2023**

Imagen	Clave del Producto y Descripción	Detalles	OEM
	<b>VW13006K</b> Cubre Polvo De Direccion	Peso : 0.29 kg / 0.639 lb	1K0423831A, 5C0423831

**TOUAREG 7LA, 7L6, 7L7 2002 - 2010**

Imagen	Clave del Producto y Descripción	Detalles	OEM
	<b>VW6067</b> Horquilla & Tijera	Peso : 8,834 kg / 19.476 lb Tipo de Material : Döküm Çelik	7L0407152F, 7L0407152J 7L0407152K, 95534101860 95534101861
	<b>VW6068</b> Horquilla & Tijera	Peso : 8,834 kg / 19.476 lb Tipo de Material : Döküm Çelik	7L0407151F, 7L0407151J 7L0407151K, 95534101760 95534101761

**TOUAREG CR7 2018 -**

Imagen	Clave del Producto y Descripción	Detalles	OEM
	<b>AU5075</b> Horquilla & Tijera	Peso : 0.55 kg / 1.213 lb Tipo de Material : Aluminio	4M0407510B, 4M0407510C 80A407510A
	<b>AU5076</b> Horquilla & Tijera	Peso : 0.55 kg / 1.213 lb Tipo de Material : Aluminio	4M0407509B, 4M0407509C 80A407509A

\* Nombres de los vehículos, marcas, modelos, símbolos y logos, número OE y otros números de terceros en el sitio web y catálogo solo son con fines de referencia.

**TOUAREG CR7 2018 -**

Imagen	Clave del Producto y Descripción	Detalles	OEM
	<b>AU5077</b> Horquilla & Tijera	Peso : 0.56 kg / 1.235 lb Tipo de Material : Aluminio	4M0407506B, 4M0407506C 80A407506A
	<b>AU5078</b> Horquilla & Tijera	Peso : 0.56 kg / 1.235 lb Tipo de Material : Aluminio	4M0407505B, 4M0407505C 80A407505A

**TOURAN 1T1, 1T2 2003 - 2010**

Imagen	Clave del Producto y Descripción	Detalles	OEM
	<b>VW12159</b> Buje De Eje	Chasis (Delantero / Trasero) : Trasera Posicion : Izquierda Y Derecha Peso : 0,130 kg / 0.287 lb	1K0505553, 1K0505553A
	<b>VW13006K</b> Cubre Polvo De Direccion	Peso : 0.29 kg / 0.639 lb	1K0423831A, 5C0423831

**TOURAN 1T3 2010 - 2015**

Imagen	Clave del Producto y Descripción	Detalles	OEM
	<b>VW12159</b> Buje De Eje	Chasis (Delantero / Trasero) : Trasera Posicion : Izquierda Y Derecha Peso : 0,130 kg / 0.287 lb	1K0505553, 1K0505553A
	<b>VW13006K</b> Cubre Polvo De Direccion	Peso : 0.29 kg / 0.639 lb	1K0423831A, 5C0423831

**TOURAN 5T1 2015 -**

Imagen	Clave del Producto y Descripción	Detalles	OEM
	<b>VW13006K</b> Cubre Polvo De Direccion	Peso : 0.29 kg / 0.639 lb	1K0423831A, 5C0423831

**TRANSPORTER V T5 2003 - 2011**

Imagen	Clave del Producto y Descripción	Detalles	OEM
	<b>VW1030K</b> Rotula	Peso : 0,600 kg / 1.323 lb Medida de Cono : Ø18,3 Diámetro del Horificio de Cono : Ø13 Diámetro de Cuerda del Perno : M14X1,5	7H8407361, 7H8407361A

**TRANSPORTER VI T5, FACELIFT 2011 - 2016**

Imagen	Clave del Producto y Descripción	Detalles	OEM
	<b>VW6061</b> Horquilla & Tijera	Peso : 8,026 kg / 17.694 lb Tipo de Material : Döküm Çelik	7E0407152B
	<b>VW6062</b> Horquilla & Tijera	Peso : 8,026 kg / 17.694 lb Tipo de Material : Döküm Çelik	7E0407151C

**TRANSPORTER VII T6 2016 - 2021**

Imagen	Clave del Producto y Descripción	Detalles	OEM
	<b>VW1030K</b> Rotula	Peso : 0,600 kg / 1.323 lb Medida de Cono : Ø18,3 Diámetro del Horificio de Cono : Ø13 Diámetro de Cuerda del Perno : M14X1,5	7H8407361, 7H8407361A

**T-ROC A11 2018 -**

Imagen	Clave del Producto y Descripción	Detalles	OEM
	<b>AU11070</b> Buje De Horquilla & Tijera	Chasis (Delantero / Trasero) : Trasera Posicion : Inferior Peso : 0,100 kg / 0.220 lb	5Q0505171, 5Q0505311C 5Q0505311CSK, 5Q0505311D 5Q0505311DSK

**RIW<sup>®</sup>**

**VOLVO**

**C70** | **1998 - 2005**

Imagen	Clave del Producto y Descripción	Detalles	OEM
	<b>VO12005</b> Buje De Puente	Chasis (Delantero / Trasero) : Delantero Posicion : Izquierda Y Derecha Peso : 0.3 kg / 0.661 lb	3507923

**S60** | **2000 - 2010**

Imagen	Clave del Producto y Descripción	Detalles	OEM
	<b>VO12005</b> Buje De Puente	Chasis (Delantero / Trasero) : Delantero Posicion : Izquierda Y Derecha Peso : 0.3 kg / 0.661 lb	3507923

**S70** | **1996 - 2000**

Imagen	Clave del Producto y Descripción	Detalles	OEM
	<b>VO12005</b> Buje De Puente	Chasis (Delantero / Trasero) : Delantero Posicion : Izquierda Y Derecha Peso : 0.3 kg / 0.661 lb	3507923

**S80** | **ITS, XY** | **1998 - 2006**

Imagen	Clave del Producto y Descripción	Detalles	OEM
	<b>VO12005</b> Buje De Puente	Chasis (Delantero / Trasero) : Delantero Posicion : Izquierda Y Derecha Peso : 0.3 kg / 0.661 lb	3507923

**V70** | **LV** | **1996 - 2000**

Imagen	Clave del Producto y Descripción	Detalles	OEM
	<b>VO12005</b> Buje De Puente	Chasis (Delantero / Trasero) : Delantero Posicion : Izquierda Y Derecha Peso : 0.3 kg / 0.661 lb	3507923

**V90** | **II** | **2016 -**

Imagen	Clave del Producto y Descripción	Detalles	OEM
	<b>VO2017</b> Terminal Exterior	Peso : 0,828 kg / 1.825 lb Longitud : 169,5 mm / 6.67 inch	31429236, 31476318 31476416

\* Nombres de los vehículos, marcas, modelos, símbolos y logos, número OE y otros números de terceros en el sitio web y catálogo solo son con fines de referencia.

**V90** **II** **2016 -**

Imagen	Clave del Producto y Descripción	Detalles	OEM
	<b>VO2018</b> Terminal Exterior	Peso : 0,828 kg / 1.825 lb Longitud : 169,5 mm / 6.67 inch	31429235, 31476317 31476415

**XC60** **II** **2017 -**

Imagen	Clave del Producto y Descripción	Detalles	OEM
	<b>VO2017</b> Terminal Exterior	Peso : 0,828 kg / 1.825 lb Longitud : 169,5 mm / 6.67 inch	31429236, 31476318 31476416
	<b>VO2018</b> Terminal Exterior	Peso : 0,828 kg / 1.825 lb Longitud : 169,5 mm / 6.67 inch	31429235, 31476317 31476415

**XC90** **I** **2002 - 2014**

Imagen	Clave del Producto y Descripción	Detalles	OEM
	<b>VO12005</b> Buje De Puente	Chasis (Delantero / Trasero) : Delantero Posicion : Izquierda Y Derecha Peso : 0.3 kg / 0.661 lb	3507923

**XC90** **II** **2015 -**

Imagen	Clave del Producto y Descripción	Detalles	OEM
	<b>VO2017</b> Terminal Exterior	Peso : 0,828 kg / 1.825 lb Longitud : 169,5 mm / 6.67 inch	31429236, 31476318 31476416
	<b>VO2018</b> Terminal Exterior	Peso : 0,828 kg / 1.825 lb Longitud : 169,5 mm / 6.67 inch	31429235, 31476317 31476415

**RIW<sup>®</sup>**

**NOTAS**



Codigo del Producto	Informacion Adicional
<b>AF2014</b> Terminal Exterior	ALFA ROMEO GT YEARS ONLY: 2007-2010
<b>AF2014</b> Terminal Exterior	ALFA ROMEO GT YEARS ONLY: 2007-2010
<b>AF2015</b> Terminal Exterior	ALFA ROMEO GT YEARS ONLY: 2007-2010
<b>AF2015</b> Terminal Exterior	ALFA ROMEO GT YEARS ONLY: 2007-2010
<b>AU11013K</b> Buje De Horquilla & Tijera	2 Pieces
<b>AU12025</b> Soporte De Amortiguador	WITHOUT AWD
<b>AU4034</b> Tornillo Estabilizador	FOR ARMOURED VEHICLES
<b>AU5071</b> Horquilla & Tijera	ALUMINUM
<b>AU5071</b> Horquilla & Tijera	ALUMINUM
<b>AU5072</b> Horquilla & Tijera	ALUMINUM
<b>AU5072</b> Horquilla & Tijera	ALUMINUM
<b>AU5073</b> Horquilla & Tijera	AUDI A4 and AUDI A5 YEAR ONLY: 2011-2015
<b>AU5073</b> Horquilla & Tijera	AUDI A4 and AUDI A5 YEAR ONLY: 2011-2015
<b>AU5074</b> Horquilla & Tijera	AUDI A4 and AUDI A5 YEAR ONLY: 2011-2015
<b>AU5074</b> Horquilla & Tijera	AUDI A4 and AUDI A5 YEAR ONLY: 2011-2015
<b>AU9020</b> Horquilla & Tijera	WITH AIR SUSPENSION
<b>BW1017</b> Rotula	4x4

Codigo del Producto	Informacion Adicional
<b>BW1018</b> Rotula	4x4
<b>BW11802</b> BUJES	KIT = BW11025 and BW11026
<b>BW20383011</b> Terminales Completas	xDrive
<b>BW20393011</b> Terminales Completas	xDrive
<b>BW2041</b> Terminal Exterior	8 SERIES and M8 : ONLY FOR xDRIVE
<b>BW2042</b> Terminal Exterior	8 SERIES and M8 : ONLY FOR xDRIVE
<b>BW2043</b> Terminal Exterior	xdrive
<b>BW2043</b> Terminal Exterior	xdrive
<b>BW20433013</b> Terminales Completas	xdrive
<b>BW2044</b> Terminal Exterior	xdrive
<b>BW2044</b> Terminal Exterior	xdrive
<b>BW20443013</b> Terminales Completas	xdrive
<b>BW3011</b> Terminal interior	xdrive
<b>BW3012</b> Terminal interior	GRAN TURISMO
<b>BW3013</b> Terminal interior	xdrive
<b>BW4069</b> Tornillo Estabilizador	RWD
<b>BW4069</b> Tornillo Estabilizador	RWD

Codigo del Producto	Informacion Adicional
<b>BW4070</b> Tornillo Estabilizador	xdrive
<b>BW5085</b> Horquilla & Tijera	xDrive
<b>BW5086</b> Horquilla & Tijera	xDrive
<b>BW5087</b> Horquilla & Tijera	RWD
<b>BW5088</b> Horquilla & Tijera	RWD
<b>BW8009</b> KIT DE SUSPENSION Y DIRECCION	BW4005 (X2) / OTHERS (X1)
<b>BW8010</b> KIT DE SUSPENSION Y DIRECCION	AU4001 (X2) / OTHERS (X1)
<b>CD2003</b> Terminal Exterior	4X2
<b>CD2004</b> Terminal Exterior	4X2
<b>CD2005</b> Terminal Exterior	4X4
<b>CD2006</b> Terminal Exterior	4X4
<b>CD4004</b> Tornillo Estabilizador	HEAVY DUTY DESIGN / BUICK RIVIERA YEARS ONLY: 1979-1989 / CADILLAC ELDORADO YEARS ONLY: 1979-1989 / CADILLAC SEVILLE YEARS ONLY: 1980-1989 / FORD GRANADA YEARS ONLY: 1975-1980 / OLDSMOBILE TORONADO YEARS ONLY: 1979-1989
<b>CI6029</b> Horquilla & Tijera	REINFORCED SUSPENSION
<b>CI6029J</b> Horquilla & Tijera	REINFORCED SUSPENSION
<b>CI6030</b> Horquilla & Tijera	REINFORCED SUSPENSION
<b>CI6030J</b> Horquilla & Tijera	REINFORCED SUSPENSION
<b>CI6033</b> Horquilla & Tijera	METAL

Codigo del Producto	Informacion Adicional
<b>CI6034</b> Horquilla & Tijera	METAL
<b>CV1027</b> Rotula	CHEVROLET HHR YEAR: 2008-2010
<b>CV1034</b> RÓTULA FRONTAL INFERIOR	FOR CHEVROLET BISCAYNE ONLY: 1971-1972 / CHEVROLET ASTRO ONLY: 2WD / FOR GMC SAFARI ONLY: 2WD
<b>CV1037</b> Rotula	4X2
<b>CV11802</b> Buje De Horquilla & Tijera	KIT = CV11030 + CV11031
<b>CV3030</b> Terminal interior	BUICK LESABRE YEARS ONLY: 2000-2003
<b>CV3036</b> Terminal interior	CHEVROLET SILVERADO 2500 YEARS ONLY: 2011-2019 / CHEVROLET SILVERADO 3500 YEARS ONLY: 2011-2019 / GMC SIERRA 2500 YEARS ONLY: 2011-2019 / GMC SIERRA 3500 YEARS ONLY: 2011-2019
<b>CV4054</b> Tornillo Estabilizador	CHEVROLET EQUINOX YEARS ONLY: 2005-2006
<b>CV4055</b> Tornillo Estabilizador	4X4 / WITHOUT ZQ8 SUSPENSION PACKAGE / ISUZU HOMBRE YEARS ONLY: 1998-2000
<b>CV4056</b> Tornillo Estabilizador	CHEVROLET TRAILBLAZER YEARS ONLY: 2008-2009 / GMC ENVOY YEARS ONLY: 2008-2009 / OLDSMOBILE VISTA CRUISER YEARS ONLY: 1971-194 / PLYMOUTH VALIANT YEARS ONLY: 1965-1972 / SAAB 9-7X YEARS ONLY: 2008-2009
<b>CV6050</b> Horquilla & Tijera	CHEVROLET HHR YEAR: 2008-2010
<b>CV6050</b> Horquilla & Tijera	CHEVROLET HHR YEAR: 2008-2010
<b>CV6051</b> Horquilla & Tijera	CHEVROLET HHR YEAR: 2008-2010
<b>CV6051</b> Horquilla & Tijera	CHEVROLET HHR YEAR: 2008-2010
<b>CV9004</b> Horquilla & Tijera	WITH 4-WHEEL DISC
<b>CV9005</b> Horquilla & Tijera	WITH 4-WHEEL DISC
<b>CV9006</b> Horquilla & Tijera	WITHOUT 4-WHEEL DISC

Codigo del Producto	Informacion Adicional
<b>CV9007</b> Horquilla & Tijera	WITHOUT 4-WHEEL DISC
<b>DO1006</b> RÓTULA FRONTAL INFERIOR	DODGE DAKOTA YEAR ONLY: 2000-2004 / DODGE DURANGO YEAR ONLY: 2000-2003 / FOR RWD
<b>DO1007</b> Rotula	2WD
<b>DO1009</b> Rotula	WITH 8 LUG WHEELS"" / 4WD
<b>DO1010</b> Rotula	PICK-UP / 4WD / DODGE RAM 2500 and RAM 3500 YEARS ONLY: 2000-2002
<b>DO1011</b> Rotula	4WD / DODGE DAKOTA YEARS ONLY: 2000-2004 / DODGE DURANGO YEARS ONLY: 2000-2003
<b>DO11010K</b> Buje De Horquilla & Tijera	2 PIECES IN 1 BOX
<b>DO11011K</b> Buje De Horquilla & Tijera	2 PIECES IN 1 BOX
<b>DO3007</b> Terminal interior	15MM THREAD / DODGE DURANGO YEARS ONLY: 2007-2009
<b>DO4012</b> Tornillo Estabilizador	2WD
<b>DO4013</b> Tornillo Estabilizador	4WD
<b>DO4014</b> Tornillo Estabilizador	4WD
<b>DO4015</b> Tornillo Estabilizador	4WD
<b>DO4016</b> Tornillo Estabilizador	2WD
<b>FI12014A</b> Soporte De Amortiguador	WITH UPGRADED BEARING VERSION
<b>FI12015A</b> Soporte De Amortiguador	WITH UPGRADED BEARING VERSION
<b>FI12804</b> Soporte De Amortiguador	FI12014 + FI12015 KIT

Codigo del Producto	Informacion Adicional
<b>FI12804</b> Soporte De Amortiguador	KIT = FI12014 FI12015
<b>FI12804A</b> Soporte De Amortiguador	KIT = FI12014A FI12015A
<b>FI13016K</b> Cubre Polvo De Direccion	2 Pieces
<b>FI3041</b> Terminal interior	WITHOUT POWER STEERING
<b>FI4029</b> Tornillo Estabilizador	YEARS: FROM 2018 -
<b>FI6111</b> Horquilla & Tijera	CASTING / ONLY FOR XENON HEADLAMPS : PAIR = FI6075
<b>FI8002</b> KIT DE SUSPENSION Y DIRECCION	FI2019 (X2) / FI3018 (X2) / FI4007 (X2) / OTHERS (X1)
<b>FO1001</b> RÓTULA FRONTAL INFERIOR	ONLY FOR 1.6i / YEAR ONLY: 2003-2008
<b>FO1054</b> Rotula	4X2
<b>FO1055</b> Rotula	WITH SINGLE AND DUAL REAR WHEELS
<b>FO12064</b> Soporte De Motor	FORD C-MAX YEARS: ONLY FROM 2015 - / FORD FOCUS YEARS: ONLY FROM 2015 - / FORD FOCUS YEARS: ONLY FROM 2016 - / FORD TRANSIT CONNECT YEARS: ONLY FROM 2016 -
<b>FO13003K</b> Cubre Polvo De Direccion	2 Pieces
<b>FO2077</b> TERMINAL EXTERIOR FRONTAL EXTERIOR	MERCURY COLONY PARK YEAR ONLY: 1987-1991
<b>FO2079</b> TERMINAL EXTERIOR FRONTAL EXTERIOR	WITHOUT HEIGHT PACKAGE / EURO MARKET
<b>FO2091</b> Terminal Exterior	4WD / EURO MADE
<b>FO2092</b> Terminal Exterior	WITH SPORT PACKAGE
<b>FO3051</b> Terminal interior	HYDRO PS / 4WD

Codigo del Producto	Informacion Adicional
<b>FO3054</b> Terminal interior	YEAR ONLY: 2010-2012
<b>FO4079</b> Tornillo Estabilizador	HEAVY DUTY DESIGN / SEDAN / LINCOLN CONTINENTAL YEARS ONLY: 1984-1991
<b>FO4080</b> Tornillo Estabilizador	FORD GRANADA YEARS ONLY: 1981-1982 / FORD LTD YEARS ONLY: 1984-1985 / FORD THUNDERBIRD YEARS ONLY: 1987-1988
<b>FO5018</b> Horquilla & Tijera	WITH PERFORMANCE PACKAGE
<b>FO5019</b> Horquilla & Tijera	WITH PERFORMANCE PACKAGE
<b>FO6107K</b> Horquilla & Tijera	WITH BIG BUSHING
<b>FO6107K</b> Horquilla & Tijera	WITH BIG BUSHING
<b>FO6108K</b> Horquilla & Tijera	WITH BIG BUSHING
<b>FO6108K</b> Horquilla & Tijera	WITH BIG BUSHING
<b>FO6132</b> Horquilla & Tijera	FORD KA YEARS ONLY: 2003-2008 / ONLY 1.6
<b>FO6133</b> Horquilla & Tijera	FORD KA YEARS ONLY: 2003-2008 / ONLY 1.6
<b>FO6134</b> Horquilla & Tijera	WITH ADJUSTABLE SUSPENSION / FORD EXPEDITION YEARS ONLY: 2005-2006 / LINCOLN NAVIGATOR YEARS ONLY: 2005-2006
<b>FO6134</b> Horquilla & Tijera	WITH ADJUSTABLE SUSPENSION / FORD EXPEDITION YEARS ONLY: 2005-2006 / LINCOLN NAVIGATOR YEARS ONLY: 2005-2006
<b>FO6135</b> Horquilla & Tijera	WITH ADJUSTABLE SUSPENSION / FORD EXPEDITION YEARS ONLY: 2005-2006 / LINCOLN NAVIGATOR YEARS ONLY: 2005-2006
<b>FO6135</b> Horquilla & Tijera	WITH ADJUSTABLE SUSPENSION / FORD EXPEDITION YEARS ONLY: 2005-2006 / LINCOLN NAVIGATOR YEARS ONLY: 2005-2006
<b>FO8003</b> KIT DE SUSPENSION Y DIRECCION	FO3010 (X2) / FO4033A (X2) / OTHERS (X1)
<b>FO9030</b> Horquilla & Tijera	WITHOUT PERFORMANCE PACKAGE

Codigo del Producto	Informacion Adicional
<b>HM2002</b> Terminal Exterior	H3T VERSION & FOR USE WITH 16MM INNER TIE RODS
<b>HN4062</b> Tornillo Estabilizador	HONDA FIT YEARS ONLY: 2015 -
<b>HN4063</b> Tornillo Estabilizador	HONDA FIT YEARS ONLY: 2015 -
<b>HN8001</b> KIT DE SUSPENSION Y DIRECCION	HN3017 (X2) / OTHERS (X1)
<b>HY1031</b> Rotula	FOR USA MARKET
<b>HY1032</b> Rotula	FOR USA MARKET
<b>HY6089J</b> HORQUILLAS FRONTAL DERECHO INFERIOR	EURO TYPE
<b>HY6090J</b> HORQUILLAS FRONTAL INFERIOR IZQUIERDO	EURO TYPE
<b>HY6103</b> Horquilla & Tijera	ALUMINUM
<b>HY6103</b> Horquilla & Tijera	ALUMINUM
<b>HY6104</b> Horquilla & Tijera	ALUMINUM
<b>HY6104</b> Horquilla & Tijera	ALUMINUM
<b>HY8001</b> KIT DE SUSPENSION Y DIRECCION	HY2004 (X2) / HY3003 (X2) / OTHERS (X1)
<b>IN3001</b> Terminal interior	YEAR ONLY: 2008-2012
<b>JG12001</b> Goma De Barra Estabilizadora	D=Ø19
<b>JG12001</b> Goma De Barra Estabilizadora	D=Ø19
<b>JG12001K</b> Goma De Barra Estabilizadora	2 PIECES IN 1 BOX / D=Ø19



Codigo del Producto	Informacion Adicional
<b>JG12001K</b> Goma De Barra Estabilizadora	2 PIECES IN 1 BOX / D=Ø19
<b>JG12002K</b> Goma De Barra Estabilizadora	2 PIECES IN 1 BOX
<b>JG12002K</b> Goma De Barra Estabilizadora	2 PIECES IN 1 BOX
<b>JG6004</b> Horquilla & Tijera	ALUMINIUM
<b>JG6005</b> Horquilla & Tijera	ALUMINIUM
<b>JP11005K</b> Buje De Horquilla & Tijera	JP11005 (X2)
<b>JP4020</b> Tornillo Estabilizador	JEEP CHEROKEE YEARS ONLY: 1991-2001 / JEEP COMANCHE YEARS ONLY: 1991-1992 / JEEP GRAND CHEROKEE YEARS ONLY: 1993-1998
<b>JP4020</b> Tornillo Estabilizador	JEEP CHEROKEE YEARS ONLY: 1991-2001 / JEEP COMANCHE YEARS ONLY: 1991-1992 / JEEP GRAND CHEROKEE YEARS ONLY: 1993-1998
<b>JP8001</b> KIT DE SUSPENSION Y DIRECCION	CY2002 (X2) / JP3004 (X2) / JP4010 (X2) / OTHERS (X1)
<b>KI3026</b> Terminal interior	KIA PICANTO YEAR ONLY: 2015-2017
<b>KI3026</b> Terminal interior	KIA PICANTO YEAR ONLY: 2015-2017
<b>KI6044</b> Horquilla & Tijera	YEARS ONLY : 2002-2006
<b>KI6045</b> Horquilla & Tijera	YEARS ONLY : 2002-2006
<b>KI6046</b> Horquilla & Tijera	YEARS ONLY : 2006-2009
<b>KI6047</b> Horquilla & Tijera	YEARS ONLY : 2006-2009
<b>LC20012002</b> Terminales Completas	TIE ROD END = LC2001 and LC2002
<b>LC2002</b> Terminal Exterior	TORSION BAR

Codigo del Producto	Informacion Adicional
<b>LR11019</b> Buje De Tornillo Estabilizador	LINK STABILIZER = LR4012
<b>LX1003</b> Rotula	AWD
<b>LX2003</b> Terminal Exterior	4X4
<b>LX2003</b> Terminal Exterior	4X4
<b>LX2004</b> Terminal Exterior	4X4
<b>LX2004</b> Terminal Exterior	4X4
<b>LX4018</b> Tornillo Estabilizador	AIR SUSPENSION / 4X4 / LEXUS RX (350) YEARS ONLY: 2010-2011 / LEXUS RX (450H) YEARS ONLY: 2010-2011
<b>LX4018</b> Tornillo Estabilizador	AIR SUSPENSION / 4X4 / LEXUS RX (350) YEARS ONLY: 2010-2011 / LEXUS RX (450H) YEARS ONLY: 2010-2011
<b>LX4019</b> Tornillo Estabilizador	AIR SUSPENSION / 4X4 / LEXUS RX (350) YEARS ONLY: 2010-2011 / LEXUS RX (450H) YEARS ONLY: 2010-2011
<b>LX4019</b> Tornillo Estabilizador	AIR SUSPENSION / 4X4 / LEXUS RX (350) YEARS ONLY: 2010-2011 / LEXUS RX (450H) YEARS ONLY: 2010-2011
<b>LX4020</b> Tornillo Estabilizador	LEXUS IS (II) (XE20) YEAR ONLY: 2006-2008
<b>LX4021</b> Tornillo Estabilizador	LEXUS IS (II) (XE20) YEAR ONLY: 2006-2008
<b>ME1028</b> Rotula	RWD / CENTER BALL JOINT
<b>ME1028</b> Rotula	RWD / CENTER BALL JOINT
<b>ME11008K</b> Buje De Horquilla & Tijera	2 Pieces
<b>ME11048K</b> Buje De Horquilla & Tijera	2 Pieces
<b>ME12060K</b> Goma De Barra Estabilizadora	2 Pieces

Codigo del Producto	Informacion Adicional
<b>ME20553020</b> Terminales Completas	RWD
<b>ME20563020</b> Terminales Completas	RWD
<b>ME20623019</b> Terminales Completas	4 MATIC
<b>ME20633019</b> Terminales Completas	4 MATIC
<b>ME20683025</b> Terminales Completas	4WD / 4 MATIC / ELECTRIC POWER SYSTEM / WITH ASD
<b>ME20693025</b> Terminales Completas	4WD / 4 MATIC / ELECTRIC POWER SYSTEM / WITH ASD
<b>ME2074</b> Terminal Exterior	4X4
<b>ME2074</b> Terminal Exterior	4X4
<b>ME2075</b> Terminal Exterior	4X4
<b>ME2075</b> Terminal Exterior	4X4
<b>ME2076</b> Terminal Exterior	RWD
<b>ME4105</b> Tornillo Estabilizador	4 MATIC / ONLY FOR YEAR: 2011-2014
<b>ME4106</b> Tornillo Estabilizador	4 MATIC / ONLY FOR YEAR: 2011-2014
<b>ME4109</b> Tornillo Estabilizador	METAL
<b>ME9019</b> Horquilla & Tijera	METAL
<b>MI11019</b> Buje De Horquilla & Tijera	SMALL
<b>MI11020</b> Buje De Horquilla & Tijera	BIG

Codigo del Producto	Informacion Adicional
<b>MI4037</b> Tornillo Estabilizador	FOR SPORT MODEL
<b>MI4037</b> Tornillo Estabilizador	FOR SPORT MODEL
<b>MI4040</b> Tornillo Estabilizador	4WD
<b>MI4040</b> Tornillo Estabilizador	4WD
<b>MI6048</b> Horquilla & Tijera	METAL
<b>MI6049</b> Horquilla & Tijera	METAL
<b>MZ8001</b> KIT DE SUSPENSION Y DIRECCION	MZ3011 (X2) / MZ4015 (X2) / OTHERS (X1)
<b>MZ8002</b> KIT DE SUSPENSION Y DIRECCION	MZ3017 (X2) / MZ5001 (X2) / OTHERS (X1)
<b>NS13006K</b> Cubre Polvo De Direccion	2 Pieces
<b>NS3036</b> Terminal interior	ONLY FOR HB
<b>NS3036</b> Terminal interior	ONLY FOR HB
<b>NS3038</b> Terminal interior	POWER STEERING
<b>NS5001</b> Horquilla & Tijera	NISSAN 350Z YEARS ONLY: 2003-2004 / INFINITI G35 YEARS ONLY: 2003-2004
<b>NS5001</b> Horquilla & Tijera	NISSAN 350Z YEARS ONLY: 2003-2004 / INFINITI G35 YEARS ONLY: 2003-2004
<b>NS5002</b> Horquilla & Tijera	NISSAN 350Z YEARS ONLY: 2003-2004 / INFINITI G35 YEARS ONLY: 2003-2004
<b>NS5002</b> Horquilla & Tijera	NISSAN 350Z YEARS ONLY: 2003-2004 / INFINITI G35 YEARS ONLY: 2003-2004
<b>NS6080</b> Horquilla & Tijera	ALUMINUM

Codigo del Producto	Informacion Adicional
<b>NS6080</b> Horquilla & Tijera	ALUMINUM
<b>NS6081</b> Horquilla & Tijera	ALUMINUM
<b>NS6081</b> Horquilla & Tijera	ALUMINUM
<b>NS8001</b> KIT DE SUSPENSION Y DIRECCION	NS3022 (X2) / NS4009 (X2) / OTHERS (X1)
<b>OP11005K</b> Buje De Horquilla & Tijera	2 Pieces
<b>OP11024K</b> Buje De Torsion	2 Pieces
<b>OP13005K</b> Cubre Polvo De Direccion	2 Pieces
<b>OP13006K</b> Cubre Polvo De Direccion	2 Pieces
<b>OP3035</b> Terminal interior	TRW STEERING REDUCED RACK
<b>OP4033</b> Tornillo Estabilizador	FWD
<b>OP4033</b> Tornillo Estabilizador	FWD
<b>OP8001</b> KIT DE SUSPENSION Y DIRECCION	OP2002 (X2) / OP3004 (X2) / OP4004 (X2) / OTHERS (X1)
<b>OP8002</b> KIT DE SUSPENSION Y DIRECCION	OP3013 (X2) / OP4007 (X2) / OTHERS (X1)
<b>PO4015</b> Tornillo Estabilizador	FOR 4WD and TURBO
<b>PO4015</b> Tornillo Estabilizador	FOR 4WD and TURBO
<b>RN12167K</b> Goma De Barra Estabilizadora	2 Pieces
<b>RN13003K</b> Cubre Polvo De Direccion	2 Pieces

Codigo del Producto	Informacion Adicional
<b>RN13004K</b> Cubre Polvo De Direccion	2 Pieces
<b>RN13011K</b> Cubre Polvo De Direccion	2 Pieces
<b>RN13022K</b> Cubre Polvo De Direccion	2 Pieces
<b>RN3023</b> Terminal interior	ONLY FOR RX4 / SMI STEERING
<b>RN8001</b> KIT DE SUSPENSION Y DIRECCION	RN3869 (X2) / RN4005 (X2) / OTHERS (X1)
<b>SK8001</b> KIT DE SUSPENSION Y DIRECCION	SK3003 (X2) / AU4001 (X2) / OTHERS (X1)
<b>SM6007</b> Horquilla & Tijera	STANDARD VERSION
<b>SM6008</b> Horquilla & Tijera	STANDARD VERSION
<b>SM6009</b> Horquilla & Tijera	FOR 16"WHEEL
<b>SM6010</b> Horquilla & Tijera	FOR 16"WHEEL
<b>TO1056</b> Rótula	HILUX YEAR ONLY: 1989-2005
<b>TO20023830</b> Terminales Completas	LEXUS RX (300) YEARS ONLY: 1999-2003
<b>TO2089</b> Terminal Exterior	USA BUILT / FOR USA MARKET / TOYOTA COROLLA YEAR ONLY: 2009-
<b>TO2090</b> Terminal Exterior	JAPAN BUILT / FOR USA MARKET / YEAR ONLY: 2007-2013
<b>TO2094</b> Terminal Exterior	RWD / X-RUNNER
<b>TO6101</b> Horquilla & Tijera	JAPAN BUILT / USA MARKET
<b>TO6101J</b> Horquilla & Tijera	JAPAN BUILT / USA MARKET

Codigo del Producto	Informacion Adicional
<b>TO6102</b> Horquilla & Tijera	JAPAN BUILT / USA MARKET
<b>TO6102J</b> Horquilla & Tijera	JAPAN BUILT / USA MARKET
<b>TO6103</b> Horquilla & Tijera	USA MARKET / JAPAN BUILT
<b>TO6104</b> Horquilla & Tijera	USA MARKET / JAPAN BUILT
<b>TO9015</b> Horquilla & Tijera	USA BUILT / SE MODEL
<b>VW12011K</b> Buje De Puente	2 Pieces
<b>VW12068K</b> Buje De Torsion	2 Pieces
<b>VW13002K</b> Cubre Polvo De Direccion	2 Pieces
<b>VW13006K</b> Cubre Polvo De Direccion	2 Pieces
<b>VW6061</b> Horquilla & Tijera	MAX 2,6T & 3.0T
<b>VW6062</b> Horquilla & Tijera	MAX 2,6T & 3.0T
<b>VW6063</b> Horquilla & Tijera	1.0 TSI
<b>VW6063</b> Horquilla & Tijera	1.0 TSI
<b>VW6063J</b> Horquilla & Tijera	1.0 TSI
<b>VW6063J</b> Horquilla & Tijera	1.0 TSI
<b>VW6064</b> Horquilla & Tijera	1.0 TSI
<b>VW6064</b> Horquilla & Tijera	1.0 TSI

Codigo del Producto	Informacion Adicional
<b>VW6064J</b> Horquilla & Tijera	1.0 TSI
<b>VW6064J</b> Horquilla & Tijera	1.0 TSI
<b>VW6067</b> Horquilla & Tijera	RUSSIA MARKET / PORSCHE CAYENNE YEARS ONLY: 2008-2010 / VOLKSWAGEN TOUAREG YEARS ONLY: 2008-2010
<b>VW6068</b> Horquilla & Tijera	RUSSIA MARKET / PORSCHE CAYENNE YEARS ONLY: 2008-2010 / VOLKSWAGEN TOUAREG YEARS ONLY: 2008-2010
<b>VW8003</b> Kit De Suspensión y Direccion	KIT = AU1014 (X1) / AU1015 (X1) / VW4011 (X2) / AU11002 (X2) / AU11005 (X2)
<b>VX12006</b> Soporte De Motor	HYDRAULIC
<b>VX12007</b> Soporte De Motor	HYDRAULIC
<b>VX12008</b> Soporte De Motor	HYDRAULIC
<b>VX12009</b> Soporte De Motor	HYDRAULIC
<b>VX12028</b> Soporte De Motor	BUICK REGAL YEARS ONLY: 2011-2013 / CADILLAC SRX YEARS ONLY: 2010-2011
<b>VX12029</b> Soporte De Motor	TRANSMISSION TYPE: M32-6
<b>VX12033</b> Soporte De Motor	HYDRAULIC
<b>VX12033</b> Soporte De Motor	HYDRAULIC
<b>VX12034</b> Soporte De Motor	HYDRAULIC
<b>VX12035</b> Soporte De Motor	HYDRAULIC
<b>VX12036</b> Soporte De Motor	HYDRAULIC
<b>VX12037</b> Soporte De Motor	HYDRAULIC