

# RIW

STEERING & SUSPENSION  
MANUFACTURER



# AUDI PRODUCT CATALOG



## Products

- Ball Joint
- Tie Rod End
- Axial Joint
- Link Stabilizer
- Control Arm
- Center Rod
- Stabilizer Mounting
- Suspension Kit
- Bush
- Tie Rod Assembly
- Mounting
- Steering Bellow
- Axle Bellow



### Hakkımızda

RIW, otomotiv yedek parça yenileme sektöründe binek ve hafif ticari araçların süspansiyon ve direksiyon parçalarını yüksek kalitede üreten ve son kullanıcının aracını güvenle kullanmasını amaçlayan ayrıca otomotiv endüstrisine ve ülke ekonomisine fayda sağlamayı kendine ilke edinen bir organizasyondur. Rotil, rotbaşı, rotmili, rot-takımı, zrot, askı rotu, ara rot, denge kolu, salıncak, burç, kauçuk ve takoz ürünlerinin montaj ve üretimlerini gerçekleştiren RIW, dünyadaki en geniş ürün çeşitliliğine sahip süspansiyon ve direksiyon parçaları üreticilerinden biridir.

Ürün çeşitliliğinin genişliği, yüksek ürün kalitesi, uygun fiyatları ve müşteri odaklı çalışmaları sonucunda Türkiye'nin en büyük yedek parça firmaları arasında yer almaktadır. Binek ve hafif ticari araçların süspansiyon ve direksiyon parçaları üretiminde Araştırma ve Geliştirme odaklı çalışmalarını en ileri ve teknolojik şartlarda yürütülmesiyle RIW Türkiye'nin en modern yedek parça üreticisidir.

RIW, firma kültüründe, teknoloji, kalite ve müşteri memnuniyetini ön planda tutularak, Türkiye'de ve dünyanın birçok ülkesinde pazarın güvenle tedarik ettiği bir markadır. RIW, modern üretim tesislerinde bulunan son teknoloji makina parkı avantajıyla tasarımdan üretime, üretimden kaliteye, paketlemeden sevkiyata, pazarlamadan satışa bütün operasyonel aşamaların yanı sıra satış sonrası hizmetlerini ve bütün bunları sağlarken göz önünde bulundurduğu çalışan memnuniyeti ve güvenliğini her zaman iyiye ve ileriye götürme prensibi sayesinde Dünya genelinde 60 'ın üzerinde ülkede saygı değer bir marka olmayı başarmıştır.

### Misyon

Dünya otomotiv yenileme sektörüne yüksek kalitede ve pazarda her zaman ilk kez geliştirilen ürünleri sunmak ve ayrıca pazardaki ürün kalitesini yükseltmek.

### Vizyon

İleri teknoloji ve sektörel deneyimin ortaya çıkardığı "RIW Standartlarından" bütün dünyanın faydalanması.

### Üretim Stratejisi

Ürün dizaynı, kalıp tasarımı, talaşlı imalat, sıcak ve soğuk dövme, alüminyum dövme, dikey ve yatay kol işleme, salıncak imalatı, kaynak, boyama, kaplama ve paketlemeden oluşan çeşitli üretim aşamaları hemen hemen her bölümün kendi tesisinde RIW mühendislerinin kontrolünde gerçekleşir. RIW üretimdeki her aşamayı farklı bir ünite olarak kabul eder ve müşteriye en hızlı ve en kaliteli ürünü sunmak için her birimin kendi planlamasını ayrı bir birim olarak hareket etmesi tezini savunur. Bu sayede büyük sermayelere ulaşmanın zor olduğu rekabetçi Pazar şartlarında RIW yatırımlarını kalitenin kontrolü ve yükseltilmesi doğrultusunda gerçekleştirir.

Üretimdeki her aşamanın bir çatı altında toplanmasını amaçlayan zihniyetin tam tersine RIW deneyimli mühendisleri sayesinde hammadde ve yarı mamül tedarikçilerinin sürekli denetlenmesini sağlar ve bu sayede kaliteyi her zaman kontrol altında tutar. Bu sistemle kalite testlerinin her aşamada uygulanması için kullanılan son teknoloji makine ve test cihazları sayesinde RIW müşterisine her zaman %100 kontrol edilmiş ürünler sunar ve ayrıca hem hata riskini sıfıra indirir hem de üretilen mamüllerin maliyetlerini düşürerek müşterisine en yüksek kaliteyi en uygun ve rekabetçi fiyatlarda sunmayı hedefler.

### Toplam Kalite Anlayışı

Toplam kalite anlayışını kendine amaç edinen RIW, yapılan yatırımlar ve kalite çalışmaları sonucunda, üretim kapasitesini devamlı arttırmış ve dünya pazarında aranan bir marka haline gelmiştir. Güvenlik parçaları üreticisi olmak bilinciyle hareket eden RIW, yüksek kalitedeki ürünlerini Avrupa, Kuzey Afrika, Ortadoğu, Avustralya, Kuzey ve Güney Amerika da yer alan birçok ülkeye aktif olarak ihraç etmektedir.

Üretimin başlangıcından bitimine kadar olan tüm aşamalarda RIW, ürünlerinin kalitesini yakından takip etmekte ve müşterilerine güvenilir ve yüksek kaliteli ürünlerin sunulduğundan emin olmaktadır. Doğru kaliteyi buluna kadar bütün testler ve işlemler, yüksek deneyime sahip RIW mühendisleri tarafından uygulanmaktadır.

### Hakkımızda

RIW, otomotiv yedek parça yenileme sektöründe binek ve hafif ticari araçların süspansiyon ve direksiyon parçalarını yüksek kalitede üreten ve son kullanıcının aracını güvenle kullanmasını amaçlayan ayrıca otomotiv endüstrisine ve ülke ekonomisine fayda sağlamayı kendine ilke edinen bir organizasyondur. Rotil, rotbaşı, rotmili, rot-takımı, zrot, askı rotu, ara rot, denge kolu, salıncak, burç, kauçuk ve takoz ürünlerinin montaj ve üretimlerini gerçekleştiren RIW, dünyadaki en geniş ürün çeşitliliğine sahip süspansiyon ve direksiyon parçaları üreticilerinden biridir.

Ürün çeşitliliğinin genişliği, yüksek ürün kalitesi, uygun fiyatları ve müşteri odaklı çalışmaları sonucunda Türkiye'nin en büyük yedek parça firmaları arasında yer almaktadır. Binek ve hafif ticari araçların süspansiyon ve direksiyon parçaları üretiminde Araştırma ve Geliştirme odaklı çalışmalarını en ileri ve teknolojik şartlarda yürütülmesiyle RIW Türkiye'nin en modern yedek parça üreticisidir.

RIW, firma kültüründe, teknoloji, kalite ve müşteri memnuniyetini ön planda tutularak, Türkiye'de ve dünyanın birçok ülkesinde pazarın güvenle tedarik ettiği bir markadır. RIW, modern üretim tesislerinde bulunan son teknoloji makina parkı avantajıyla tasarımdan üretime, üretimden kaliteye, paketlenmeden sevkiyata, pazarlamadan satışa bütün operasyonel aşamaların yanı sıra satış sonrası hizmetlerini ve bütün bunları sağlarken göz önünde bulundurduğu çalışan memnuniyeti ve güvenliğini her zaman iyiye ve ileriye götürme prensibi sayesinde Dünya genelinde 60 'ın üzerinde ülkede saygı değer bir marka olmayı başarmıştır.

### Misyon

Dünya otomotiv yenileme sektörüne yüksek kalitede ve pazarda her zaman ilk kez geliştirilen ürünleri sunmak ve ayrıca pazardaki ürün kalitesini yükseltmek.

### Vizyon

İleri teknoloji ve sektörel deneyimin ortaya çıkardığı "RIW Standartlarından" bütün dünyanın faydalanması.

### Üretim Stratejisi

Ürün dizaynı, kalıp tasarımı, talaşlı imalat, sıcak ve soğuk dövme, alüminyum dövme, dikey ve yatay kol işleme, salıncak imalatı, kaynak, boyama, kaplama ve paketlenmeden oluşan çeşitli üretim aşamaları hemen hemen her bölümün kendi tesisinde RIW mühendislerinin kontrolünde gerçekleşir. RIW üretimdeki her aşamayı farklı bir ünite olarak kabul eder ve müşteriye en hızlı ve en kaliteli ürünü sunmak için her birimin kendi planlamasını ayrı bir birim olarak hareket etmesi tezini savunur. Bu sayede büyük sermayelere ulaşmanın zor olduğu rekabetçi Pazar şartlarında RIW yatırımlarını kalitenin kontrolü ve yükseltilmesi doğrultusunda gerçekleştirir.

Üretimdeki her aşamanın bir çatı altında toplanmasını amaçlayan zihniyetin tam tersine RIW deneyimli mühendisleri sayesinde hammadde ve yarı mamül tedarikçilerinin sürekli denetlenmesini sağlar ve bu sayede kaliteyi her zaman kontrol altında tutar. Bu sistemle kalite testlerinin her aşamada uygulanması için kullanılan son teknoloji makine ve test cihazları sayesinde RIW müşterisine her zaman %100 kontrol edilmiş ürünler sunar ve ayrıca hem hata riskini sıfıra indirir hem de üretilen mamüllerin maliyetlerini düşürerek müşterisine en yüksek kaliteyi en uygun ve rekabetçi fiyatlarda sunmayı hedefler.

### Toplam Kalite Anlayışı

Toplam kalite anlayışını kendine amaç edinen RIW, yapılan yatırımlar ve kalite çalışmaları sonucunda, üretim kapasitesini devamlı arttırmış ve dünya pazarında aranan bir marka haline gelmiştir. Güvenlik parçaları üreticisi olmak bilinciyle hareket eden RIW, yüksek kalitedeki ürünlerini Avrupa, Kuzey Afrika, Ortadoğu, Avustralya, Kuzey ve Güney Amerika da yer alan birçok ülkeye aktif olarak ihraç etmektedir.

Üretimin başlangıcından bitimine kadar olan tüm aşamalarda RIW, ürünlerinin kalitesini yakından takip etmekte ve müşterilerine güvenilir ve yüksek kaliteli ürünlerin sunulduğundan emin olmaktadır. Doğru kaliteyi buluna kadar bütün testler ve işlemler, yüksek deneyime sahip RIW mühendisleri tarafından uygulanmaktadır.

- The codes which has 6 characters are suspension parts (Additional codes are exceptional)
- The codes which has 7 characters are rubber parts (Additional codes are exceptional)
- There is no any specific code for Rod Assembly.
- Rod Assembly codes are the combine of Tie Rod End and Axial Joint.
- Same parts which are used at the different cars might have the same code.

## PE 6 001 J

### Brand

<b>AC</b> ACURA	<b>DC</b> DACIA	<b>IS</b> ISUZU	<b>LE</b> LEYLAND	<b>PE</b> PEUGEOT	<b>SM</b> SMART
<b>AF</b> ALFA ROMEO	<b>DW</b> DAEWOO	<b>IV</b> IVECO	<b>LC</b> LINCOLN	<b>PO</b> PORSCHE	<b>SY</b> SSANGYONG
<b>AU</b> AUDI	<b>DH</b> DAIHATSU	<b>JG</b> JAGUAR	<b>LO</b> LOTUS	<b>PR</b> PROTON	<b>SU</b> SUBARU
<b>BW</b> BMW	<b>DO</b> DODGE	<b>JP</b> JEEP	<b>MZ</b> MAZDA	<b>RE</b> RENAULT	<b>SZ</b> SUZUKI
<b>BU</b> BUICK	<b>FI</b> FIAT	<b>KI</b> KIA	<b>ME</b> MERCEDES	<b>RR</b> ROLLS-ROYCE	<b>TO</b> TOYOTA
<b>CD</b> CADILLAC	<b>FO</b> FORD	<b>LD</b> LADA	<b>MC</b> MINI COOPER	<b>RO</b> ROVER	<b>VA</b> VAUXHALL
<b>CV</b> CHEVROLET	<b>HN</b> HONDA	<b>LR</b> LAND ROVER	<b>MI</b> MITSUBISHI	<b>SA</b> SAAB	<b>VW</b> VOLKSWAGEN
<b>CY</b> CHRYSLER	<b>HY</b> HYUNDAI	<b>LV</b> LDV	<b>NS</b> NISSAN	<b>SE</b> SEAT	<b>VO</b> VOLVO
<b>CI</b> CITROËN	<b>IK</b> IKCO	<b>LX</b> LEXUS	<b>OP</b> OPEL	<b>SK</b> SKODA	

PE

### Product Group

<b>1</b> BALL JOINT	<b>7</b> CENTER ROD & DRAG LINK	<b>23</b> TIE ROD ASSEMBLY
<b>2</b> TIE ROD END	<b>8</b> SUSPENSION KITS	<b>12</b> MOUNTING & RUBBER SUPPORT
<b>3</b> AXIAL JOINT (INNER TIE ROD)	<b>9</b> REAR WISHBONE AND CONTROL ARM	<b>128</b> MOUNTING or RUBBER SUPPORT KIT
<b>4</b> LINK STABILIZER	<b>10</b> BUSH	<b>13</b> BELLOW STEERING
<b>5</b> CONTROL ARM	<b>11</b> BUSH	<b>14</b> BELLOW DRIVE SHAFT
<b>6</b> WISHBONE	<b>118</b> REPAIR & BUSH KIT	

6

### Numbers

001 Any Number ■

### Option











#### ADDITIONALS CODES AND MEANINGS

<b>K</b> K FOR BALL JOINTS	<b>B</b> B FOR WISHBONE and CONTROL ARMS
VW1012K 1 = BALL JOINT K = WITH EXTRA ACCESSORIES	BW5005B 5 = CONTROL ARM B = WITHOUT BUSHING
VW1012 1 = BALL JOINT	BW5005 5 = CONTROL ARM (The similar as OE part)
<b>J</b> J FOR WISHBONES	<b>K</b> K FOR MOUNTINGS (RUBBER PARTS)
PE6001J 6 = WISHBONE J = WITHOUT BALL JOINT	CV12005K 12 = MOUNTING K = KIT, 2 PIECES or WITH EXTRA ACCESSORIES
PE6001 6 = WISHBONE (The similar as the OE part)	CV12005 12 = MOUNTING (The similar as OE part)
<b>K</b> K FOR WISHBONES or CONTROL ARMS (5,6 or 9)	<b>A</b> THE PRODUCT HAS DIFFERENT OPTION
BW6005K 6 = WISHBONE K = WITH EXTRA ACCESSORIES	FO4030A 4 = LINK STABILIZER A = OPTION (metal, rubber), plastic etc)
BW6005 6 = WISHBONE	FO4030 4 = LINK STABILIZER (The similar as OE part)





J

**RIW®**





**AUDI**

Resim	Ürün Kodu ve Açıklaması	Detay	OEM
	<b>AU2316</b> ROTBAŞI SOL RB2316	Ağırlık : 0,335 kg / 0.739 lb Uzunluk : 74 mm / 2.91 inch Gövde Diş Çapı : M18X1,5 Aşık Diş Çapı : M12X1,5 Aşık Konik Çapı : Ø12,6	4A0419811A
	<b>AU2317</b> ROTBAŞI SAĞ RB2317	Ağırlık : 0,337 kg / 0.743 lb Uzunluk : 74 mm / 2.91 inch Gövde Diş Çapı : M18X1,5 Aşık Diş Çapı : M12X1,5 Aşık Konik Çapı : Ø12,6	4A0419812A
	<b>AU4002</b> Z ROT ARKA SAĞ - SOL METAL RB2919	Ağırlık : 0,266 kg / 0.586 lb Malzeme Türü : Metal Uzunluk : 122 mm / 4.80 inch Aşık Diş Çapı : M10X1,5	4A0505389
	<b>AU5005</b> SALINCAK ÖN SAĞ RB2614	Malzeme Türü : Dövme Çelik	4A0407152
	<b>AU5006</b> SALINCAK ÖN SOL RB2613	Malzeme Türü : Dövme Çelik	4A0407151
	<b>AU11008</b> SALINCAK VE DENGE KOLU BURCU ARKA SOL VE SAĞ	Şasi (Ön / Arka) : ARKA Yön : Sol Ve Sağ Ağırlık : 0,269 kg / 0.593 lb	4A0511247
	<b>AU11011</b> SALINCAK VE DENGE KOLU BURCU ÖN SOL VE SAĞ B22122	Şasi (Ön / Arka) : ÖN Yön : Sol Ve Sağ Ağırlık : 0,322 kg / 0.710 lb	4A0407183C, 4A0407183D
	<b>AU11013</b> SALINCAK VE DENGE KOLU BURCU ÖN ORTA SOL VE SAĞ B22121	Şasi (Ön / Arka) : ÖN Yön : Orta Sol Ve Sağ Ağırlık : 0,095 kg / 0.209 lb	4A0407181, 4A0407181A
	<b>AU11013K</b> SALINCAK VE DENGE KOLU BURCU ÖN ORTA SOL VE SAĞ	Şasi (Ön / Arka) : ÖN Yön : Orta Sol Ve Sağ Ağırlık : 0,095 kg / 0.209 lb Not : 2 Pieces	4A0407181, 4A0407181A
	<b>AU12003</b> VİRAJ DEMİR LASTİĞİ SOL VE SAĞ	Şasi (Ön / Arka) : ÖN Yön : Sol Ve Sağ Ağırlık : 0,130 kg / 0.287 lb	4A0411327A
	<b>VW12022</b> AMORTİSÖR TAKOZU SOL VE SAĞ AMORTİSÖR TAKOZU	Yön : Sol Ve Sağ Ağırlık : 0.44 kg / 0.970 lb Not : AMORTİSÖR TAKOZU	4D0412377F

**100**
**1991 - 1994**

Resim	Ürün Kodu ve Açıklaması	Detay	OEM
	<b>AU11027</b> ŞANZIMAN TAKOZU SOL VE SAĞ	Yön : Sol Ve Sağ Ağırlık : 0,256 kg / 0.564 lb	443399419
	<b>AU11031</b> ŞANZIMAN TAKOZU SOL VE SAĞ	Yön : Sol Ve Sağ Ağırlık : 0,188 kg / 0.414 lb	431399415B, 443399415A
	<b>AU12016</b> ŞANZIMAN TAKOZU SOL VE SAĞ ŞANZUMAN TAKOZU	Yön : Sol Ve Sağ Ağırlık : 0,267 kg / 0.589 lb Not : ŞANZUMAN TAKOZU	431399151D
	<b>AU12017</b> ŞANZIMAN TAKOZU SOL VE SAĞ ŞANZUMAN TAKOZU	Yön : Sol Ve Sağ Ağırlık : 0,535 kg / 1.179 lb Not : ŞANZUMAN TAKOZU	4A0399151D, 4A0399151K
	<b>VW14001</b> AKS KÖRÜĞÜ +KELEPÇE+YAĞ. DIŞ	Ağırlık : 0.14 kg / 0.309 lb	441 407 203A, 441407203A

**100**
**43, C2**
**1976 - 1982**

Resim	Ürün Kodu ve Açıklaması	Detay	OEM
	<b>AU2312</b> ROTBAŞI SAĞ RB2312	Ağırlık : 0,297 kg / 0.655 lb Uzunluk : 73 mm / 2.87 inch Gövde Diş Çapı : M14X1,5 Aşık Diş Çapı : M12X1,5 Aşık Konik Çapı : Ø12,6	443419812A, 443419812C
	<b>AU2313</b> ROTBAŞI SOL RB2313	Ağırlık : 0,306 kg / 0.675 lb Uzunluk : 73 mm / 2.87 inch Gövde Diş Çapı : M14X1,5 Aşık Diş Çapı : M12X1,5 Aşık Konik Çapı : Ø12,6	443419811A, 443419811C 443419811D
	<b>AU2314</b> ROTBAŞI SAĞ RB2314	Ağırlık : 0,302 kg / 0.666 lb Uzunluk : 73 mm / 2.87 inch Gövde Diş Çapı : M16X1,5 Aşık Diş Çapı : M12X1,5 Aşık Konik Çapı : Ø12,6	443419812B, 443419812D
	<b>AU2315</b> ROTBAŞI SOL RB2315	Ağırlık : 0,307 kg / 0.677 lb Uzunluk : 73 mm / 2.87 inch Gövde Diş Çapı : M16X1,5 Aşık Diş Çapı : M12X1,5 Aşık Konik Çapı : Ø12,6	443419811B, 443419811D
	<b>AU5001</b> SALINCAK ÖN SAĞ RB2612	Malzeme Türü : Dövme Çelik	437407152A, 437407156A

\* Bu sayfada ve katalogdaki tüm araçların adları, markaları, modelleri, sembolleri, logoları, orjinal numaraları (oe) ve diğer üçüncü parti numaraları sadece referans amaçlı kullanılmaktadır.

**100** **43, C2** **1976 - 1982**

Resim	Ürün Kodu ve Açıklaması	Detay	OEM
	<b>AU5002</b> SALINCAK ÖN SOL RB2611	Malzeme Türü : Dövme Çelik	437407151A, 437407155A
	<b>AU5003</b> SALINCAK ÖN SAĞ	Malzeme Türü : Dövme Çelik	437407152, 437407156
	<b>AU5004</b> SALINCAK ÖN SOL	Malzeme Türü : Dövme Çelik	437407151, 437407155
	<b>AU11009</b> SALINCAK VE DENGİ KOLU BURCU ARKA SOL VE SAĞ B22177	Şasi (Ön / Arka) : ARKA Yön : Sol Ve Sağ Ağırlık : 0,218 kg / 0.481 lb	431407183A
	<b>AU11010</b> SALINCAK VE DENGİ KOLU BURCU ÖN ORTA SOL VE SAĞ B22176	Şasi (Ön / Arka) : ÖN Yön : Orta Sol Ve Sağ Ağırlık : 0,092 kg / 0.203 lb Not : ORTA	431407181F, 431407182 431407201C
	<b>AU12034</b> ŞANZIMAN TAKOZU	Ağırlık : 0,556 kg / 1.226 lb	811199339A, 811199339B 823199339A
	<b>AU12012</b> EGSOZ TAKOZU ÖN SOL VE SAĞ EGSOZ LASTİĞİ	Şasi (Ön / Arka) : ÖN Yön : Sol Ve Sağ Ağırlık : 0.034 kg / 0.075 lb Not : EGSOZ LASTİĞİ	191253147B, 4A0253147A
	<b>OP14003</b> AKS KÖRÜĞÜ +KELEPÇE+YAĞ. AKS KÖRÜĞÜ DIŞ	Ağırlık : 0.2 kg / 0.441 lb	1603180
	<b>RN14006</b> AKS KÖRÜĞÜ +KELEPÇE+YAĞ. DIŞ	Ağırlık : 0.2 kg / 0.441 lb	1603180, 1603204 16410170470106*, 16500170470106* 1H0498203, 271648 271649, 321498203A 431498203C, 443498203D

**100** **44, 44Q, C3** **1982 - 1991**

Resim	Ürün Kodu ve Açıklaması	Detay	OEM
	<b>AU2312</b> ROTBAŞI SAĞ RB2312	Ağırlık : 0,297 kg / 0.655 lb Uzunluk : 73 mm / 2.87 inch Gövde Diş Çapı : M14X1,5 Aşık Diş Çapı : M12X1,5 Aşık Konik Çapı : Ø12,6	443419812A, 443419812C

\* Bu sayfada ve katalogdaki tüm araçların adları, markaları, modelleri, sembolleri, logoları, orijinal numaraları (oe) ve diğer üçüncü parti numaraları sadece referans amaçlı kullanılmaktadır.









**100**
**44, 44Q, C3**
**1982 - 1991**





Resim	Ürün Kodu ve Açıklaması	Detay	OEM
	<b>AU2313</b> ROTBAŞI SOL RB2313	Ağırlık : 0,306 kg / 0.675 lb Uzunluk : 73 mm / 2.87 inch Gövde Diş Çapı : M14X1,5 Aşık Diş Çapı : M12X1,5 Aşık Konik Çapı : Ø12,6	443419811A, 443419811C 443419811D
	<b>AU2314</b> ROTBAŞI SAĞ RB2314	Ağırlık : 0,302 kg / 0.666 lb Uzunluk : 73 mm / 2.87 inch Gövde Diş Çapı : M16X1,5 Aşık Diş Çapı : M12X1,5 Aşık Konik Çapı : Ø12,6	443419812B, 443419812D
	<b>AU2315</b> ROTBAŞI SOL RB2315	Ağırlık : 0,307 kg / 0.677 lb Uzunluk : 73 mm / 2.87 inch Gövde Diş Çapı : M16X1,5 Aşık Diş Çapı : M12X1,5 Aşık Konik Çapı : Ø12,6	443419811B, 443419811D
	<b>AU5001</b> SALINCAK ÖN SAĞ RB2612	Malzeme Türü : Dövme Çelik	437407152A, 437407156A
	<b>AU5002</b> SALINCAK ÖN SOL RB2611	Malzeme Türü : Dövme Çelik	437407151A, 437407155A
	<b>AU5003</b> SALINCAK ÖN SAĞ	Malzeme Türü : Dövme Çelik	437407152, 437407156
	<b>AU5004</b> SALINCAK ÖN SOL	Malzeme Türü : Dövme Çelik	437407151, 437407155
	<b>AU11009</b> SALINCAK VE DENGİ KOLU BURCU ARKA SOL VE SAĞ B22177	Şasi (Ön / Arka) : ARKA Yön : Sol Ve Sağ Ağırlık : 0,218 kg / 0.481 lb	431407183A
	<b>AU11010</b> SALINCAK VE DENGİ KOLU BURCU ÖN ORTA SOL VE SAĞ B22176	Şasi (Ön / Arka) : ÖN Yön : Orta Sol Ve Sağ Ağırlık : 0,092 kg / 0.203 lb Not : ORTA	431407181F, 431407182 431407201C
	<b>AU11028</b> BEŞİK (TRAVERS) BURCU SOL VE SAĞ	Yön : Sol Ve Sağ Ağırlık : 0,218 kg / 0.481 lb Not : AKS KOVANI TAKOZU	431511247C
	<b>AU11038</b> BEŞİK (TRAVERS) BURCU SOL VE SAĞ	Yön : Sol Ve Sağ Ağırlık : 0,091 kg / 0.201 lb Not : ARKA AKS KOVANI LASTİK	443511247D

\* Bu sayfada ve katalogdaki tüm araçların adları, markaları, modelleri, sembolleri, logoları, orijinal numaraları (oe) ve diğer üçüncü parti numaraları sadece referans amaçlı kullanılmaktadır.











**100**
**44, 44Q, C3**
**1982 - 1991**

Resim	Ürün Kodu ve Açıklaması	Detay	OEM
	<b>AU12018</b> VİRAJ DEMİR LASTİĞİ SOL VE SAĞ	Şasi (Ön / Arka) : ÖN Yön : Sol Ve Sağ Ağırlık : 0,076 kg / 0.168 lb Not : KAÇUK	431411327A
	<b>AU12018K</b> VİRAJ DEMİR LASTİĞİ SOL VE SAĞ	Şasi (Ön / Arka) : ÖN Yön : Sol Ve Sağ Ağırlık : 0.152 kg / 0.335 lb Not : KAÇUK	431411327A
	<b>AU11027</b> ŞANZIMAN TAKOZU SOL VE SAĞ	Yön : Sol Ve Sağ Ağırlık : 0.256 kg / 0.564 lb	443399419
	<b>AU11031</b> ŞANZIMAN TAKOZU SOL VE SAĞ	Yön : Sol Ve Sağ Ağırlık : 0,188 kg / 0.414 lb	431399415B, 443399415A
	<b>AU12016</b> ŞANZIMAN TAKOZU SOL VE SAĞ ŞANZUMAN TAKOZU	Yön : Sol Ve Sağ Ağırlık : 0,267 kg / 0.589 lb Not : ŞANZUMAN TAKOZU	431399151D
	<b>AU12034</b> ŞANZIMAN TAKOZU	Ağırlık : 0,556 kg / 1.226 lb	811199339A, 811199339B 823199339A







**80**
**1974 - 1981**

Resim	Ürün Kodu ve Açıklaması	Detay	OEM
	<b>AU1001</b> ROTİL SAĞ-SOL ALT RB2511	Ağırlık : 0,45 kg / 0.992 lb Bağlantı Delik Çapı : Ø10,5	823407365A, 823407365C
	<b>AU1002</b> ROTİL ÖN SAĞ - SOL RB2512	Ağırlık : 0,46 kg / 1.014 lb Bağlantı Delik Çapı : Ø10,5	321413025B, 321413026B 823407365E
	<b>AU2213</b> ROTBAŞI ÖN SAĞ - SOL RB2213	Ağırlık : 0,315 kg / 0.694 lb Uzunluk : 100 mm / 3.94 inch Gövde Diş Çapı : M14X1,5 Aşık Diş Çapı : M10X1 Aşık Konik Çapı : Ø10,6	321419811, 811419812 823419811, 861419802 861419812
	<b>AU6001</b> SALINCAK ÖN	Ağırlık : 2,31 kg / 5.093 lb Malzeme Türü : Sac Metal	3074071551C*, 811407147B* 893407147G*



\* Bu sayfada ve katalogdaki tüm araçların adları, markaları, modelleri, sembolleri, logoları, orjinal numaraları (oe) ve diğer üçüncü parti numaraları sadece referans amaçlı kullanılmaktadır.

Resim	Ürün Kodu ve Açıklaması	Detay	OEM
	<b>AU6001J</b> SALINCAK ÖN RB3102	Ağırlık : 1,866 kg / 4.114 lb Malzeme Türü : Sac Metal	3074071551C, 811407147B 893407147G
	<b>AU11046</b> SALINCAK VE DENGE KOLU BURCU SOL VE SAĞ	Yön : Sol Ve Sağ Ağırlık : 0,118 kg / 0.260 lb	811407181, 811407181A
	<b>AU11046K</b> SALINCAK VE DENGE KOLU BURCU SOL VE SAĞ	Yön : Sol Ve Sağ Ağırlık : 0,236 kg / 0.520 lb	811407181, 811407181A
	<b>AU12007</b> VİRAJ DEMİR LASTİĞİ SOL VE SAĞ RUBBER	Şasi (Ön / Arka) : ÖN Yön : Sol Ve Sağ Ağırlık : 0,02 kg / 0.044 lb Malzeme Türü : Rubber	823411327B
	<b>AU12007K</b> VİRAJ DEMİR LASTİĞİ SOL VE SAĞ RUBBER	Şasi (Ön / Arka) : ÖN Yön : Sol Ve Sağ Ağırlık : 0,04 kg / 0.088 lb Malzeme Türü : Rubber	823411327B*, 823411327B
	<b>AU12008</b> VİRAJ DEMİR LASTİĞİ SOL VE SAĞ RUBBER	Şasi (Ön / Arka) : ÖN Yön : Sol Ve Sağ Ağırlık : 0,03 kg / 0.066 lb Malzeme Türü : Rubber	823411313A*, 823411313A
	<b>AU12008K</b> VİRAJ DEMİR LASTİĞİ SOL VE SAĞ RUBBER	Şasi (Ön / Arka) : ÖN Yön : Sol Ve Sağ Ağırlık : 0,06 kg / 0.132 lb Malzeme Türü : Rubber	823411313A*
	<b>VW12104</b> AMORTİSÖR TAKOZU SOL VE SAĞ AMORTİSÖR TABLASI	Yön : Sol Ve Sağ Ağırlık : 0,257 kg / 0.567 lb Not : AMORTİSÖR TABLASI	811412323C, 811412323D 8A0412323B, 8A0412323D
	<b>VW12104K</b> AMORTİSÖR TAKOZU SOL VE SAĞ 2 PCS	Yön : Sol Ve Sağ Ağırlık : 0,514 kg / 1.133 lb Not : 2 PCS	811412323C, 811412323D 8A0412323B, 8A0412323D
	<b>AU12009</b> MOTOR TAKOZU ÖN SOL VE SAĞ	Şasi (Ön / Arka) : ÖN Yön : Sol Ve Sağ Ağırlık : 0,464 kg / 1.023 lb	823199381B, 893199381B
	<b>AU12034</b> ŞANZİMAN TAKOZU	Ağırlık : 0,556 kg / 1.226 lb	811199339A, 811199339B 823199339A

\* Bu sayfada ve katalogdaki tüm araçların adları, markaları, modelleri, sembolleri, logoları, orijinal numaraları (oe) ve diğer üçüncü parti numaraları sadece referans amaçlı kullanılmaktadır.

Resim	Ürün Kodu ve Açıklaması	Detay	OEM
	<b>AU1003</b> ROTİL ÖN SAĞ RB2515	Ağırlık : 0,58 kg / 1.279 lb Bağlantı Delik Çapı : Ø10,5	855407366A, 855407366B
	<b>AU1004</b> ROTİL ÖN SOL RB2514	Ağırlık : 0,58 kg / 1.279 lb Bağlantı Delik Çapı : Ø10,5	855407365A, 855407365B
	<b>AU2311</b> ROTBAŞI ÖN SAĞ - SOL RB2311	Ağırlık : 0,218 kg / 0.481 lb Uzunluk : 75 mm / 2.95 inch Gövde Diş Çapı : M14X1,5 Aşık Diş Çapı : M10X1 Aşık Konik Çapı : Ø11	811419812A, 811419812B 8A0419812
	<b>AU4001</b> Z ROT SOL VE SAĞ METAL RB2911	Ağırlık : 0,357 kg / 0.787 lb Malzeme Türü : Metal Uzunluk : 270 mm / 10.63 inch Aşık Diş Çapı : M10X1,5	893407465, 893407465A 8A0407465, 8A0407465B 8A0407465C
	<b>AU4001A</b> Z ROT ÖN PLASTİK	Ağırlık : 0,295 kg / 0.650 lb Malzeme Türü : Plastik Uzunluk : 317 mm / 12.48 inch	893407465, 893407465A 8A0407465, 8A0407465B 8A0407465C
	<b>AU4022</b> Z ROT ARKA	Ağırlık : 0.873 kg / 1.925 lb	893505389, 895505389
	<b>AU6002</b> SALINCAK ÖN SAĞ	Ağırlık : 2,816 kg / 6.208 lb Malzeme Türü : Sac Metal	893407148C*
	<b>AU6002J</b> SALINCAK ÖN SAĞ RB3105	Ağırlık : 2,226 kg / 4.907 lb Malzeme Türü : Sac Metal	893407148C
	<b>AU6003</b> SALINCAK ÖN SOL	Ağırlık : 2,816 kg / 6.208 lb Malzeme Türü : Sac Metal	893407147C*
	<b>AU6003J</b> SALINCAK ÖN SOL RB3106	Ağırlık : 2,147 kg / 4.733 lb Malzeme Türü : Sac Metal	893407147C, 893407147E
	<b>AU11001</b> SALINCAK VE DENGİ KOLU BURCU ÖN İÇ SOL VE SAĞ B22128	Şasi (Ön / Arka) : ÖN Yön : İç Sol Ve Sağ Ağırlık : 0,158 kg / 0.348 lb Not : L=44mm/İN D=Ø10,2mm/O D=Ø37,1m	857407181, 8A0407181

\* Bu sayfada ve katalogdaki tüm araçların adları, markaları, modelleri, sembolleri, logoları, orjinal numaraları (oe) ve diğer üçüncü parti numaraları sadece referans amaçlı kullanılmaktadır.

Resim	Ürün Kodu ve Açıklaması	Detay	OEM
	<b>AU12015</b> TAŞIYICI DESTEK BURÇLARI ARKA SOL VE SAĞ	Şasi (Ön / Arka) : ARKA Yön : Sol Ve Sağ Ağırlık : 0,12 kg / 0.265 lb	811511247
	<b>AU12015K</b> TAŞIYICI DESTEK BURÇLARI ARKA SOL VE SAĞ	Şasi (Ön / Arka) : ARKA Yön : Sol Ve Sağ Ağırlık : 0,24 kg / 0.529 lb	811511247
	<b>AU12007</b> VİRAJ DEMİR LASTİĞİ SOL VE SAĞ RUBBER	Şasi (Ön / Arka) : ÖN Yön : Sol Ve Sağ Ağırlık : 0,02 kg / 0.044 lb Malzeme Türü : Rubber	823411327B
	<b>AU12007K</b> VİRAJ DEMİR LASTİĞİ SOL VE SAĞ RUBBER	Şasi (Ön / Arka) : ÖN Yön : Sol Ve Sağ Ağırlık : 0,04 kg / 0.088 lb Malzeme Türü : Rubber	823411327B*, 823411327B
	<b>AU12008</b> VİRAJ DEMİR LASTİĞİ SOL VE SAĞ RUBBER	Şasi (Ön / Arka) : ÖN Yön : Sol Ve Sağ Ağırlık : 0,03 kg / 0.066 lb Malzeme Türü : Rubber	823411313A*, 823411313A
	<b>AU12008K</b> VİRAJ DEMİR LASTİĞİ SOL VE SAĞ RUBBER	Şasi (Ön / Arka) : ÖN Yön : Sol Ve Sağ Ağırlık : 0,06 kg / 0.132 lb Malzeme Türü : Rubber	823411313A*
	<b>VW12104</b> AMORTİSÖR TAKOZU SOL VE SAĞ AMORTİSOR TABLASI	Yön : Sol Ve Sağ Ağırlık : 0,257 kg / 0.567 lb Not : AMORTİSOR TABLASI	811412323C, 811412323D 8A0412323B, 8A0412323D
	<b>VW12104K</b> AMORTİSÖR TAKOZU SOL VE SAĞ 2 PCS	Yön : Sol Ve Sağ Ağırlık : 0,514 kg / 1.133 lb Not : 2 PCS	811412323C, 811412323D 8A0412323B, 8A0412323D
	<b>AU12009</b> MOTOR TAKOZU ÖN SOL VE SAĞ	Şasi (Ön / Arka) : ÖN Yön : Sol Ve Sağ Ağırlık : 0,464 kg / 1.023 lb	823199381B, 893199381B
	<b>AU12010</b> MOTOR TAKOZU ÖN SOL VE SAĞ ŞANZUMAN TAKOZU	Şasi (Ön / Arka) : ÖN Yön : Sol Ve Sağ Ağırlık : 0,4 kg / 0.882 lb Not : ŞANZUMAN TAKOZU	893399151A
	<b>AU12013</b> MOTOR TAKOZU ÖN SOL VE SAĞ VERS BURCU	Şasi (Ön / Arka) : ÖN Yön : Sol Ve Sağ Ağırlık : 0,129 kg / 0.284 lb Not : VERS BURCU	811199415A, 893199415

\* Bu sayfada ve katalogdaki tüm araçların adları, markaları, modelleri, sembolleri, logoları, orjinal numaraları (oe) ve diğer üçüncü parti numaraları sadece referans amaçlı kullanılmaktadır.



**80**
**1981 - 1988**

Resim	Ürün Kodu ve Açıklaması	Detay	OEM
	<b>AU12014</b> MOTOR TAKOZU ÖN SOL VE SAĞ TRAVERS BURCU ARKA	Şasi (Ön / Arka) : ÖN Yön : Sol Ve Sağ Ağırlık : 0,118 kg / 0.260 lb Not : TRAVERS BURCU ARKA	811199419B, 811199419C 893199419
	<b>AU12011</b> ŞANZIMAN TAKOZU SOL VE SAĞ ŞANZUMAN TAKOZU	Şasi (Ön / Arka) : ÖN Yön : Sol Ve Sağ Ağırlık : 0,26 kg / 0.573 lb Not : ŞANZUMAN TAKOZU	811399151B
	<b>AU12016</b> ŞANZIMAN TAKOZU SOL VE SAĞ ŞANZUMAN TAKOZU	Yön : Sol Ve Sağ Ağırlık : 0,267 kg / 0.589 lb Not : ŞANZUMAN TAKOZU	431399151D
	<b>AU12034</b> ŞANZIMAN TAKOZU	Ağırlık : 0,556 kg / 1.226 lb	811199339A, 811199339B 823199339A
	<b>AU12012</b> EGSOZ TAKOZU ÖN SOL VE SAĞ EGSOZ LASTİĞİ	Şasi (Ön / Arka) : ÖN Yön : Sol Ve Sağ Ağırlık : 0,034 kg / 0.075 lb Not : EGSOZ LASTİĞİ	191253147B, 4A0253147A
	<b>OP14003</b> AKS KÖRÜĞÜ +KELEPÇE+YAĞ. AKS KÖRÜĞÜ DIŞ	Ağırlık : 0.2 kg / 0.441 lb	1603180
	<b>RN14006</b> AKS KÖRÜĞÜ +KELEPÇE+YAĞ. DIŞ	Ağırlık : 0.2 kg / 0.441 lb	1603180, 1603204 16410170470106*, 16500170470106* 1H0498203, 271648 271649, 321498203A 431498203C, 443498203D
	<b>VW14013</b> AKS KÖRÜĞÜ +KELEPÇE+YAĞ. YAĞ+KELEPÇE	Ağırlık : 0.156 kg / 0.344 lb	113501149, 171407283A
	<b>VW14014</b> AKS KÖRÜĞÜ +KELEPÇE+YAĞ. YAĞ+KELEPÇE	Ağırlık : 0.28 kg / 0.617 lb	191498203C, 71498203

**80**
**1989 - 1991**

Resim	Ürün Kodu ve Açıklaması	Detay	OEM
	<b>AU1005</b> ROTİL ÖN SAĞ RB2517	Ağırlık : 0,59 kg / 1.301 lb Bağlantı Delik Çapı : Ø10,5	893407366, 893407366F

\* Bu sayfada ve katalogdaki tüm araçların adları, markaları, modelleri, sembolleri, logoları, orjinal numaraları (oe) ve diğer üçüncü parti numaraları sadece referans amaçlı kullanılmaktadır.

Resim	Ürün Kodu ve Açıklaması	Detay	OEM
	<b>AU1006</b> ROTİL ÖN SOL RB2516	Ağırlık : 0,59 kg / 1.301 lb Bağlantı Delik Çapı : Ø10,5	893407365, 893407365B 893407365F
	<b>AU1007</b> ROTİL SAĞ RB2521	Ağırlık : 0,485 kg / 1.069 lb Bağlantı Delik Çapı : Ø10,5	893407366A
	<b>AU1008</b> ROTİL SOL RB2520	Ağırlık : 0,485 kg / 1.069 lb Bağlantı Delik Çapı : Ø10,5	893407365A
	<b>AU1009</b> ROTİL SAĞ RB2523	Ağırlık : 0,53 kg / 1.168 lb Bağlantı Delik Çapı : Ø10,5	855407366
	<b>AU1010</b> ROTİL SOL RB2522	Ağırlık : 0,53 kg / 1.168 lb Bağlantı Delik Çapı : Ø10,5	855407365
	<b>AU2311</b> ROTBAŞI ÖN SAĞ - SOL RB2311	Ağırlık : 0,218 kg / 0.481 lb Uzunluk : 75 mm / 2.95 inch Gövde Diş Çapı : M14X1,5 Aşık Diş Çapı : M10X1 Aşık Konik Çapı : Ø11	811419812A, 811419812B 8A0419812
	<b>AU4001</b> Z ROT SOL VE SAĞ METAL RB2911	Ağırlık : 0,357 kg / 0.787 lb Malzeme Türü : Metal Uzunluk : 270 mm / 10.63 inch Aşık Diş Çapı : M10X1,5	893407465, 893407465A 8A0407465, 8A0407465B 8A0407465C
	<b>AU4001A</b> Z ROT ÖN PLASTİK	Ağırlık : 0,295 kg / 0.650 lb Malzeme Türü : Plastik Uzunluk : 317 mm / 12.48 inch	893407465, 893407465A 8A0407465, 8A0407465B 8A0407465C
	<b>AU6004</b> SALINCAK ÖN SAĞ	Ağırlık : 2,817 kg / 6.210 lb Malzeme Türü : Sac Metal	893407148E*
	<b>AU6004J</b> SALINCAK ÖN SAĞ RB3107	Ağırlık : 2,185 kg / 4.817 lb Malzeme Türü : Sac Metal	893407148E
	<b>AU6005</b> SALINCAK ÖN SOL	Ağırlık : 2,77 kg / 6.107 lb Malzeme Türü : Sac Metal	893407147E*, 893407147E

\* Bu sayfada ve katalogdaki tüm araçların adları, markaları, modelleri, sembolleri, logoları, orjinal numaraları (oe) ve diğer üçüncü parti numaraları sadece referans amaçlı kullanılmaktadır.

Resim	Ürün Kodu ve Açıklaması	Detay	OEM
	<b>AU6005J</b> SALINCAK ÖN SOL	Ağırlık : 2,178 kg / 4.802 lb Malzeme Türü : Sac Metal	893407147E
	<b>AU11001</b> SALINCAK VE DENGE KOLU BURCU ÖN İÇ SOL VE SAĞ B22128	Şasi (Ön / Arka) : ÖN Yön : İç Sol Ve Sağ Ağırlık : 0,158 kg / 0.348 lb Not : L=44mm/IN D=Ø10,2mm/O D=Ø37,1m	857407181, 8A0407181
	<b>AU12007</b> VİRAJ DEMİR LASTİĞİ SOL VE SAĞ RUBBER	Şasi (Ön / Arka) : ÖN Yön : Sol Ve Sağ Ağırlık : 0,02 kg / 0.044 lb Malzeme Türü : Rubber	823411327B
	<b>AU12007K</b> VİRAJ DEMİR LASTİĞİ SOL VE SAĞ RUBBER	Şasi (Ön / Arka) : ÖN Yön : Sol Ve Sağ Ağırlık : 0,04 kg / 0.088 lb Malzeme Türü : Rubber	823411327B*, 823411327B
	<b>AU12008</b> VİRAJ DEMİR LASTİĞİ SOL VE SAĞ RUBBER	Şasi (Ön / Arka) : ÖN Yön : Sol Ve Sağ Ağırlık : 0,03 kg / 0.066 lb Malzeme Türü : Rubber	823411313A*, 823411313A
	<b>AU12008K</b> VİRAJ DEMİR LASTİĞİ SOL VE SAĞ RUBBER	Şasi (Ön / Arka) : ÖN Yön : Sol Ve Sağ Ağırlık : 0,06 kg / 0.132 lb Malzeme Türü : Rubber	823411313A*
	<b>VW12104</b> AMORTİSÖR TAKOZU SOL VE SAĞ AMORTİSOR TABLASI	Yön : Sol Ve Sağ Ağırlık : 0,257 kg / 0.567 lb Not : AMORTİSOR TABLASI	811412323C, 811412323D 8A0412323B, 8A0412323D
	<b>VW12104K</b> AMORTİSÖR TAKOZU SOL VE SAĞ 2 PCS	Yön : Sol Ve Sağ Ağırlık : 0,514 kg / 1.133 lb Not : 2 PCS	811412323C, 811412323D 8A0412323B, 8A0412323D
	<b>AU12009</b> MOTOR TAKOZU ÖN SOL VE SAĞ	Şasi (Ön / Arka) : ÖN Yön : Sol Ve Sağ Ağırlık : 0,464 kg / 1.023 lb	823199381B, 893199381B
	<b>AU12010</b> MOTOR TAKOZU ÖN SOL VE SAĞ ŞANZUMAN TAKOZU	Şasi (Ön / Arka) : ÖN Yön : Sol Ve Sağ Ağırlık : 0,4 kg / 0.882 lb Not : ŞANZUMAN TAKOZU	893399151A
	<b>AU12013</b> MOTOR TAKOZU ÖN SOL VE SAĞ VERS BURCU	Şasi (Ön / Arka) : ÖN Yön : Sol Ve Sağ Ağırlık : 0,129 kg / 0.284 lb Not : VERS BURCU	811199415A, 893199415

\* Bu sayfada ve katalogdaki tüm araçların adları, markaları, modelleri, sembolleri, logoları, orjinal numaraları (oe) ve diğer üçüncü parti numaraları sadece referans amaçlı kullanılmaktadır.



**80**
**1989 - 1991**

Resim	Ürün Kodu ve Açıklaması	Detay	OEM
	<b>AU12014</b> MOTOR TAKOZU ÖN SOL VE SAĞ TRAVERS BURCU ARKA	Şasi (Ön / Arka) : ÖN Yön : Sol Ve Sağ Ağırlık : 0,118 kg / 0.260 lb Not : TRAVERS BURCU ARKA	811199419B, 811199419C 893199419
	<b>AU12011</b> ŞANZIMAN TAKOZU SOL VE SAĞ ŞANZUMAN TAKOZU	Şasi (Ön / Arka) : ÖN Yön : Sol Ve Sağ Ağırlık : 0,26 kg / 0.573 lb Not : ŞANZUMAN TAKOZU	811399151B
	<b>AU12034</b> ŞANZIMAN TAKOZU	Ağırlık : 0,556 kg / 1.226 lb	811199339A, 811199339B 823199339A
	<b>AU12012</b> EGSOZ TAKOZU ÖN SOL VE SAĞ EGSOZ LASTİĞİ	Şasi (Ön / Arka) : ÖN Yön : Sol Ve Sağ Ağırlık : 0.034 kg / 0.075 lb Not : EGSOZ LASTİĞİ	191253147B, 4A0253147A
	<b>OP14003</b> AKS KÖRÜĞÜ +KELEPÇE+YAĞ. AKS KÖRÜĞÜ DİŞ	Ağırlık : 0.2 kg / 0.441 lb	1603180
	<b>RN14006</b> AKS KÖRÜĞÜ +KELEPÇE+YAĞ. DİŞ	Ağırlık : 0.2 kg / 0.441 lb	1603180, 1603204 16410170470106*, 16500170470106* 1H0498203, 271648 271649, 321498203A
	<b>VW14013</b> AKS KÖRÜĞÜ +KELEPÇE+YAĞ. YAĞ+KELEPÇE	Ağırlık : 0.156 kg / 0.344 lb	113501149, 171407283A
	<b>VW14014</b> AKS KÖRÜĞÜ +KELEPÇE+YAĞ. YAĞ+KELEPÇE	Ağırlık : 0.28 kg / 0.617 lb	191498203C, 71498203







**80**
**1992 - 1994**

Resim	Ürün Kodu ve Açıklaması	Detay	OEM
	<b>AU1011</b> ROTİL ÖN SOL RB2524	Ağırlık : 0,565 kg / 1.246 lb Bağlantı Delik Çapı : Ø10,5	893.407.365B, 893.407.365D 893407365B, 893407365D 894407365E, 895407365 8A0.407.365, 8A0407365
	<b>AU1012</b> ROTİL ÖN SAĞ RB2525	Ağırlık : 0,565 kg / 1.246 lb Bağlantı Delik Çapı : Ø10,5	893407366B, 894407366E 895407366, 8A0.407.366 8A0407366

\* Bu sayfada ve katalogdaki tüm araçların adları, markaları, modelleri, sembolleri, logoları, orjinal numaraları (oe) ve diğer üçüncü parti numaraları sadece referans amaçlı kullanılmaktadır.

Resim	Ürün Kodu ve Açıklaması	Detay	OEM
	<b>AU2311</b> ROTBAŞI ÖN SAĞ - SOL RB2311	Ağırlık : 0,218 kg / 0.481 lb Uzunluk : 75 mm / 2.95 inch Gövde Diş Çapı : M14X1,5 Aşık Diş Çapı : M10X1 Aşık Konik Çapı : Ø11	811419812A, 811419812B 8A0419812
	<b>AU4001</b> Z ROT SOL VE SAĞ METAL RB2911	Ağırlık : 0,357 kg / 0.787 lb Malzeme Türü : Metal Uzunluk : 270 mm / 10.63 inch Aşık Diş Çapı : M10X1,5	893407465, 893407465A 8A0407465, 8A0407465B 8A0407465C
	<b>AU4001A</b> Z ROT ÖN PLASTİK	Ağırlık : 0,295 kg / 0.650 lb Malzeme Türü : Plastik Uzunluk : 317 mm / 12.48 inch	893407465, 893407465A 8A0407465, 8A0407465B 8A0407465C
	<b>AU4003</b> Z ROT SAĞ RB2913	Ağırlık : 0,406 kg / 0.895 lb Uzunluk : 226,5 mm / 8.92 inch Aşık Diş Çapı : M10X1,5	8A0505466C, 8D0505466
	<b>AU4004</b> Z ROT SOL RB2914	Ağırlık : 0,404 kg / 0.891 lb Uzunluk : 226,5 mm / 8.92 inch Aşık Diş Çapı : M10X1,5	8A0505465C, 8D0505465
	<b>AU6006</b> SALINCAK ÖN SAĞ	Ağırlık : 2,596 kg / 5.723 lb Malzeme Türü : Sac Metal	895407148A*, 895407148A
	<b>AU6006J</b> SALINCAK ÖN SAĞ RB3109	Ağırlık : 1,947 kg / 4.292 lb Malzeme Türü : Sac Metal	895407148A
	<b>AU6007</b> SALINCAK ÖN SOL	Ağırlık : 2,672 kg / 5.891 lb Malzeme Türü : Sac Metal	895407147A*, 895407147A
	<b>AU6007J</b> SALINCAK ÖN SOL RB3108	Ağırlık : 1,987 kg / 4.381 lb Malzeme Türü : Sac Metal	895407147A
	<b>AU11001</b> SALINCAK VE DENGE KOLU BURCU ÖN İÇ SOL VE SAĞ B22128	Şasi (Ön / Arka) : ÖN Yön : İç Sol Ve Sağ Ağırlık : 0,158 kg / 0.348 lb Not : L=44mm/IN D=Ø10,2mm/O D=Ø37,1m	857407181, 8A0407181
	<b>AU11030</b> SALINCAK VE DENGE KOLU BURCU SOL VE SAĞ	Yön : Sol Ve Sağ Ağırlık : 0,21 kg / 0.463 lb	893407181

\* Bu sayfada ve katalogdaki tüm araçların adları, markaları, modelleri, sembolleri, logoları, orjinal numaraları (oe) ve diğer üçüncü parti numaraları sadece referans amaçlı kullanılmaktadır.







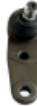

Resim	Ürün Kodu ve Açıklaması	Detay	OEM
	<b>AU11024</b> Z-ROT BURCU ARKA	Şasi (Ön / Arka) : ARKA Ağırlık : 0.55 kg / 1.213 lb Uzunluk : AU4003 mm / 0.00 inch Aşık Diş Çapı : AU4004	8A0505465C*, 8A0505466C* 8D0505465*, 8D0505466*
	<b>AU12002</b> BEŞİK (TRAVERS) BURCU ARKA SOL VE SAĞ	Şasi (Ön / Arka) : ARKA Yön : Sol Ve Sağ Ağırlık : 0.53 kg / 1.168 lb	8A0501541
	<b>VW12020</b> VİRAJ DEMİR LASTİĞİ SOL VE SAĞ RUBBER	Şasi (Ön / Arka) : ÖN Yön : Sol Ve Sağ Ağırlık : 0.07 kg / 0.154 lb Malzeme Türü : Rubber Not : VİRAJ ORTA LASTİĞİ	8D0511327C
	<b>VW12020K</b> VİRAJ DEMİR LASTİĞİ SOL VE SAĞ RUBBER	Şasi (Ön / Arka) : ÖN Yön : Sol Ve Sağ Ağırlık : 0.14 kg / 0.309 lb Malzeme Türü : Rubber	8D0511327C*
	<b>VW12104</b> AMORTİSÖR TAKOZU SOL VE SAĞ AMORTİSÖR TABLASI	Yön : Sol Ve Sağ Ağırlık : 0,257 kg / 0.567 lb Not : AMORTİSÖR TABLASI	811412323C, 811412323D 8A0412323B, 8A0412323D
	<b>VW12104K</b> AMORTİSÖR TAKOZU SOL VE SAĞ 2 PCS	Yön : Sol Ve Sağ Ağırlık : 0.514 kg / 1.133 lb Not : 2 PCS	811412323C, 811412323D 8A0412323B, 8A0412323D
	<b>AU12013</b> MOTOR TAKOZU ÖN SOL VE SAĞ VERS BURCU	Şasi (Ön / Arka) : ÖN Yön : Sol Ve Sağ Ağırlık : 0,129 kg / 0.284 lb Not : VERS BURCU	811199415A, 893199415
	<b>AU12014</b> MOTOR TAKOZU ÖN SOL VE SAĞ TRAVERS BURCU ARKA	Şasi (Ön / Arka) : ÖN Yön : Sol Ve Sağ Ağırlık : 0,118 kg / 0.260 lb Not : TRAVERS BURCU ARKA	811199419B, 811199419C 893199419
	<b>AU12034</b> ŞANZİMAN TAKOZU	Ağırlık : 0,556 kg / 1.226 lb	811199339A, 811199339B 823199339A
	<b>RN14006</b> AKS KÖRÜĞÜ +KELEPÇE+YAĞ. DIŞ	Ağırlık : 0.2 kg / 0.441 lb	1603180, 1603204 16410170470106*, 16500170470106* 1H0498203, 271648 271649, 321498203A 431498203C, 443498203D
	<b>VW14001</b> AKS KÖRÜĞÜ +KELEPÇE+YAĞ. DIŞ	Ağırlık : 0.14 kg / 0.309 lb	441 407 203A, 441407203A

\* Bu sayfada ve katalogdaki tüm araçların adları, markaları, modelleri, sembolleri, logoları, orjinal numaraları (oe) ve diğer üçüncü parti numaraları sadece referans amaçlı kullanılmaktadır.

**80**
**1992 - 1994**





Resim	Ürün Kodu ve Açıklaması	Detay	OEM
	<b>VW14013</b> AKS KÖRÜĞÜ +KELEPÇE+YAĞ. YAĞ+KELEPÇE	Ağırlık : 0.156 kg / 0.344 lb	113501149, 171407283A

**90**
**1974 - 1981**





Resim	Ürün Kodu ve Açıklaması	Detay	OEM
	<b>AU1001</b> ROTİL SAĞ-SOL ALT RB2511	Ağırlık : 0,45 kg / 0.992 lb Bağlantı Delik Çapı : Ø10,5	823407365A, 823407365C
	<b>AU1002</b> ROTİL ÖN SAĞ - SOL RB2512	Ağırlık : 0,46 kg / 1.014 lb Bağlantı Delik Çapı : Ø10,5	321413025B, 321413026B 823407365E
	<b>AU2213</b> ROTBAŞI ÖN SAĞ - SOL RB2213	Ağırlık : 0,315 kg / 0.694 lb Uzunluk : 100 mm / 3.94 inch Gövde Diş Çapı : M14X1,5 Aşık Diş Çapı : M10X1 Aşık Konik Çapı : Ø10,6	321419811, 811419812 823419811, 861419802 861419812
	<b>AU6001</b> SALINCAK ÖN	Ağırlık : 2,31 kg / 5.093 lb Malzeme Türü : Sac Metal	3074071551C*, 811407147B* 893407147G*
	<b>AU6001J</b> SALINCAK ÖN RB3102	Ağırlık : 1,866 kg / 4.114 lb Malzeme Türü : Sac Metal	3074071551C, 811407147B 893407147G
	<b>AU11046</b> SALINCAK VE DENGE KOLU BURCU SOL VE SAĞ	Yön : Sol Ve Sağ Ağırlık : 0,118 kg / 0.260 lb	811407181, 811407181A
	<b>AU11046K</b> SALINCAK VE DENGE KOLU BURCU SOL VE SAĞ	Yön : Sol Ve Sağ Ağırlık : 0,236 kg / 0.520 lb	811407181, 811407181A
	<b>AU12007</b> VİRAJ DEMİR LASTİĞİ SOL VE SAĞ RUBBER	Şasi (Ön / Arka) : ÖN Yön : Sol Ve Sağ Ağırlık : 0,02 kg / 0.044 lb Malzeme Türü : Rubber	823411327B
	<b>AU12007K</b> VİRAJ DEMİR LASTİĞİ SOL VE SAĞ RUBBER	Şasi (Ön / Arka) : ÖN Yön : Sol Ve Sağ Ağırlık : 0.04 kg / 0.088 lb Malzeme Türü : Rubber	823411327B*, 823411327B

\* Bu sayfada ve katalogdaki tüm araçların adları, markaları, modelleri, sembolleri, logoları, orjinal numaraları (oe) ve diğer üçüncü parti numaraları sadece referans amaçlı kullanılmaktadır.

**90**
**1974 - 1981**

Resim	Ürün Kodu ve Açıklaması	Detay	OEM
	<b>AU12008</b> VİRAJ DEMİR LASTİĞİ SOL VE SAĞ RUBBER	Şasi (Ön / Arka) : ÖN Yön : Sol Ve Sağ Ağırlık : 0,03 kg / 0.066 lb Malzeme Türü : Rubber	823411313A*, 823411313A
	<b>AU12008K</b> VİRAJ DEMİR LASTİĞİ SOL VE SAĞ RUBBER	Şasi (Ön / Arka) : ÖN Yön : Sol Ve Sağ Ağırlık : 0.06 kg / 0.132 lb Malzeme Türü : Rubber	823411313A*
	<b>VW12104</b> AMORTİSÖR TAKOZU SOL VE SAĞ AMORTİSOR TABLASI	Yön : Sol Ve Sağ Ağırlık : 0,257 kg / 0.567 lb Not : AMORTİSOR TABLASI	811412323C, 811412323D 8A0412323B, 8A0412323D
	<b>VW12104K</b> AMORTİSÖR TAKOZU SOL VE SAĞ 2 PCS	Yön : Sol Ve Sağ Ağırlık : 0.514 kg / 1.133 lb Not : 2 PCS	811412323C, 811412323D 8A0412323B, 8A0412323D
	<b>AU12009</b> MOTOR TAKOZU ÖN SOL VE SAĞ	Şasi (Ön / Arka) : ÖN Yön : Sol Ve Sağ Ağırlık : 0,464 kg / 1.023 lb	823199381B, 893199381B

**90**
**1981 - 1988**

Resim	Ürün Kodu ve Açıklaması	Detay	OEM
	<b>AU1003</b> ROTİL ÖN SAĞ RB2515	Ağırlık : 0,58 kg / 1.279 lb Bağlantı Delik Çapı : Ø10,5	855407366A, 855407366B
	<b>AU1004</b> ROTİL ÖN SOL RB2514	Ağırlık : 0,58 kg / 1.279 lb Bağlantı Delik Çapı : Ø10,5	855407365A, 855407365B
	<b>AU2311</b> ROTBAŞI ÖN SAĞ - SOL RB2311	Ağırlık : 0,218 kg / 0.481 lb Uzunluk : 75 mm / 2.95 inch Gövde Diş Çapı : M14X1,5 Aşık Diş Çapı : M10X1 Aşık Konik Çapı : Ø11	811419812A, 811419812B 8A0419812
	<b>AU4001</b> Z ROT SOL VE SAĞ METAL RB2911	Ağırlık : 0,357 kg / 0.787 lb Malzeme Türü : Metal Uzunluk : 270 mm / 10.63 inch Aşık Diş Çapı : M10X1,5	893407465, 893407465A 8A0407465, 8A0407465B 8A0407465C
	<b>AU4001A</b> Z ROT ÖN PLASTİK	Ağırlık : 0,295 kg / 0.650 lb Malzeme Türü : Plastik Uzunluk : 317 mm / 12.48 inch	893407465, 893407465A 8A0407465, 8A0407465B 8A0407465C

\* Bu sayfada ve katalogdaki tüm araçların adları, markaları, modelleri, sembolleri, logoları, orjinal numaraları (oe) ve diğer üçüncü parti numaraları sadece referans amaçlı kullanılmaktadır.





Resim	Ürün Kodu ve Açıklaması	Detay	OEM
	<b>AU4022</b> Z ROT ARKA	Ağırlık : 0.873 kg / 1.925 lb	893505389, 895505389
	<b>AU6002</b> SALINCAK ÖN SAĞ	Ağırlık : 2,816 kg / 6.208 lb Malzeme Türü : Sac Metal	893407148C*
	<b>AU6002J</b> SALINCAK ÖN SAĞ RB3105	Ağırlık : 2,226 kg / 4.907 lb Malzeme Türü : Sac Metal	893407148C
	<b>AU6003</b> SALINCAK ÖN SOL	Ağırlık : 2,816 kg / 6.208 lb Malzeme Türü : Sac Metal	893407147C*
	<b>AU6003J</b> SALINCAK ÖN SOL RB3106	Ağırlık : 2,147 kg / 4.733 lb Malzeme Türü : Sac Metal	893407147C, 893407147E
	<b>AU11001</b> SALINCAK VE DENGE KOLU BURCU ÖN İÇ SOL VE SAĞ B22128	Şasi (Ön / Arka) : ÖN Yön : İç Sol Ve Sağ Ağırlık : 0,158 kg / 0.348 lb Not : L=44mm/İN D=Ø10,2mm/O D=Ø37,1m	857407181, 8A0407181
	<b>AU12015</b> TAŞIYICI DESTEK BURÇLARI ARKA SOL VE SAĞ	Şasi (Ön / Arka) : ARKA Yön : Sol Ve Sağ Ağırlık : 0,12 kg / 0.265 lb	811511247
	<b>AU12015K</b> TAŞIYICI DESTEK BURÇLARI ARKA SOL VE SAĞ	Şasi (Ön / Arka) : ARKA Yön : Sol Ve Sağ Ağırlık : 0,24 kg / 0.529 lb	811511247
	<b>AU12007</b> VİRAJ DEMİR LASTİĞİ SOL VE SAĞ RUBBER	Şasi (Ön / Arka) : ÖN Yön : Sol Ve Sağ Ağırlık : 0,02 kg / 0.044 lb Malzeme Türü : Rubber	823411327B
	<b>AU12007K</b> VİRAJ DEMİR LASTİĞİ SOL VE SAĞ RUBBER	Şasi (Ön / Arka) : ÖN Yön : Sol Ve Sağ Ağırlık : 0.04 kg / 0.088 lb Malzeme Türü : Rubber	823411327B*, 823411327B
	<b>AU12008</b> VİRAJ DEMİR LASTİĞİ SOL VE SAĞ RUBBER	Şasi (Ön / Arka) : ÖN Yön : Sol Ve Sağ Ağırlık : 0,03 kg / 0.066 lb Malzeme Türü : Rubber	823411313A*, 823411313A

\* Bu sayfada ve katalogdaki tüm araçların adları, markaları, modelleri, sembolleri, logoları, orjinal numaraları (oe) ve diğer üçüncü parti numaraları sadece referans amaçlı kullanılmaktadır.







Resim	Ürün Kodu ve Açıklaması	Detay	OEM
	<b>AU12008K</b> VİRAJ DEMİR LASTİĞİ SOL VE SAĞ RUBBER	Şasi (Ön / Arka) : ÖN Yön : Sol Ve Sağ Ağırlık : 0.06 kg / 0.132 lb Malzeme Türü : Rubber	823411313A*
	<b>VW12104</b> AMORTİSÖR TAKOZU SOL VE SAĞ AMORTİSOR TABLASI	Yön : Sol Ve Sağ Ağırlık : 0,257 kg / 0.567 lb Not : AMORTİSOR TABLASI	811412323C, 811412323D 8A0412323B, 8A0412323D
	<b>VW12104K</b> AMORTİSÖR TAKOZU SOL VE SAĞ 2 PCS	Yön : Sol Ve Sağ Ağırlık : 0.514 kg / 1.133 lb Not : 2 PCS	811412323C, 811412323D 8A0412323B, 8A0412323D
	<b>AU12009</b> MOTOR TAKOZU ÖN SOL VE SAĞ	Şasi (Ön / Arka) : ÖN Yön : Sol Ve Sağ Ağırlık : 0,464 kg / 1.023 lb	823199381B, 893199381B
	<b>AU12010</b> MOTOR TAKOZU ÖN SOL VE SAĞ ŞANZUMAN TAKOZU	Şasi (Ön / Arka) : ÖN Yön : Sol Ve Sağ Ağırlık : 0,4 kg / 0.882 lb Not : ŞANZUMAN TAKOZU	893399151A
	<b>AU12013</b> MOTOR TAKOZU ÖN SOL VE SAĞ VERS BURCU	Şasi (Ön / Arka) : ÖN Yön : Sol Ve Sağ Ağırlık : 0,129 kg / 0.284 lb Not : VERS BURCU	811199415A, 893199415
	<b>AU12014</b> MOTOR TAKOZU ÖN SOL VE SAĞ TRAVERS BURCU ARKA	Şasi (Ön / Arka) : ÖN Yön : Sol Ve Sağ Ağırlık : 0,118 kg / 0.260 lb Not : TRAVERS BURCU ARKA	811199419B, 811199419C 893199419
	<b>AU12011</b> ŞANZİMAN TAKOZU SOL VE SAĞ ŞANZUMAN TAKOZU	Şasi (Ön / Arka) : ÖN Yön : Sol Ve Sağ Ağırlık : 0,26 kg / 0.573 lb Not : ŞANZUMAN TAKOZU	811399151B
	<b>AU12016</b> ŞANZİMAN TAKOZU SOL VE SAĞ ŞANZUMAN TAKOZU	Yön : Sol Ve Sağ Ağırlık : 0,267 kg / 0.589 lb Not : ŞANZUMAN TAKOZU	431399151D
	<b>AU12034</b> ŞANZİMAN TAKOZU	Ağırlık : 0,556 kg / 1.226 lb	811199339A, 811199339B 823199339A
	<b>AU12012</b> EGSOZ TAKOZU ÖN SOL VE SAĞ EGSOZ LASTİĞİ	Şasi (Ön / Arka) : ÖN Yön : Sol Ve Sağ Ağırlık : 0.034 kg / 0.075 lb Not : EGSOZ LASTİĞİ	191253147B, 4A0253147A

\* Bu sayfada ve katalogdaki tüm araçların adları, markaları, modelleri, sembolleri, logoları, orjinal numaraları (oe) ve diğer üçüncü parti numaraları sadece referans amaçlı kullanılmaktadır.

**90**
**1981 - 1988**











Resim	Ürün Kodu ve Açıklaması	Detay	OEM
	<b>OP14003</b> AKS KÖRÜĞÜ +KELEPÇE+YAĞ. AKS KÖRÜĞÜ DIŞ	Ağırlık : 0.2 kg / 0.441 lb	1603180
	<b>RN14006</b> AKS KÖRÜĞÜ +KELEPÇE+YAĞ. DIŞ	Ağırlık : 0.2 kg / 0.441 lb	1603180, 1603204 16410170470106*, 16500170470106* 1H0498203, 271648 271649, 321498203A
	<b>VW14013</b> AKS KÖRÜĞÜ +KELEPÇE+YAĞ. YAĞ+KELEPÇE	Ağırlık : 0.156 kg / 0.344 lb	113501149, 171407283A
	<b>VW14014</b> AKS KÖRÜĞÜ +KELEPÇE+YAĞ. YAĞ+KELEPÇE	Ağırlık : 0.28 kg / 0.617 lb	191498203C, 71498203

**90**
**1989 - 1991**

Resim	Ürün Kodu ve Açıklaması	Detay	OEM
	<b>AU1005</b> ROTİL ÖN SAĞ RB2517	Ağırlık : 0,59 kg / 1.301 lb Bağlantı Delik Çapı : Ø10,5	893407366, 893407366F
	<b>AU1006</b> ROTİL ÖN SOL RB2516	Ağırlık : 0,59 kg / 1.301 lb Bağlantı Delik Çapı : Ø10,5	893407365, 893407365B 893407365F
	<b>AU1007</b> ROTİL SAĞ RB2521	Ağırlık : 0,485 kg / 1.069 lb Bağlantı Delik Çapı : Ø10,5	893407366A
	<b>AU1008</b> ROTİL SOL RB2520	Ağırlık : 0,485 kg / 1.069 lb Bağlantı Delik Çapı : Ø10,5	893407365A
	<b>AU1009</b> ROTİL SAĞ RB2523	Ağırlık : 0,53 kg / 1.168 lb Bağlantı Delik Çapı : Ø10,5	855407366
	<b>AU1010</b> ROTİL SOL RB2522	Ağırlık : 0,53 kg / 1.168 lb Bağlantı Delik Çapı : Ø10,5	855407365

\* Bu sayfada ve katalogdaki tüm araçların adları, markaları, modelleri, sembolleri, logoları, orjinal numaraları (oe) ve diğer üçüncü parti numaraları sadece referans amaçlı kullanılmaktadır.

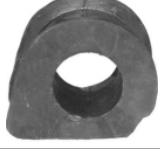

Resim	Ürün Kodu ve Açıklaması	Detay	OEM
	<b>AU2311</b> ROTBAŞI ÖN SAĞ - SOL RB2311	Ağırlık : 0,218 kg / 0.481 lb Uzunluk : 75 mm / 2.95 inch Gövde Diş Çapı : M14X1,5 Aşık Diş Çapı : M10X1 Aşık Konik Çapı : Ø11	811419812A, 811419812B 8A0419812
	<b>AU4001</b> Z ROT SOL VE SAĞ METAL RB2911	Ağırlık : 0,357 kg / 0.787 lb Malzeme Türü : Metal Uzunluk : 270 mm / 10.63 inch Aşık Diş Çapı : M10X1,5	893407465, 893407465A 8A0407465, 8A0407465B 8A0407465C
	<b>AU4001A</b> Z ROT ÖN PLASTİK	Ağırlık : 0,295 kg / 0.650 lb Malzeme Türü : Plastik Uzunluk : 317 mm / 12.48 inch	893407465, 893407465A 8A0407465, 8A0407465B 8A0407465C
	<b>AU6004</b> SALINCAK ÖN SAĞ	Ağırlık : 2,817 kg / 6.210 lb Malzeme Türü : Sac Metal	893407148E*
	<b>AU6004J</b> SALINCAK ÖN SAĞ RB3107	Ağırlık : 2,185 kg / 4.817 lb Malzeme Türü : Sac Metal	893407148E
	<b>AU6005</b> SALINCAK ÖN SOL	Ağırlık : 2,77 kg / 6.107 lb Malzeme Türü : Sac Metal	893407147E*, 893407147E
	<b>AU6005J</b> SALINCAK ÖN SOL	Ağırlık : 2,178 kg / 4.802 lb Malzeme Türü : Sac Metal	893407147E
	<b>AU11001</b> SALINCAK VE DENGE KOLU BURCU ÖN İÇ SOL VE SAĞ B22128	Şasi (Ön / Arka) : ÖN Yön : İç Sol Ve Sağ Ağırlık : 0,158 kg / 0.348 lb Not : L=44mm/IN D=Ø10,2mm/O D=Ø37,1m	857407181, 8A0407181
	<b>AU12007</b> VİRAJ DEMİR LASTİĞİ SOL VE SAĞ RUBBER	Şasi (Ön / Arka) : ÖN Yön : Sol Ve Sağ Ağırlık : 0,02 kg / 0.044 lb Malzeme Türü : Rubber	823411327B
	<b>AU12007K</b> VİRAJ DEMİR LASTİĞİ SOL VE SAĞ RUBBER	Şasi (Ön / Arka) : ÖN Yön : Sol Ve Sağ Ağırlık : 0.04 kg / 0.088 lb Malzeme Türü : Rubber	823411327B*, 823411327B
	<b>AU12008</b> VİRAJ DEMİR LASTİĞİ SOL VE SAĞ RUBBER	Şasi (Ön / Arka) : ÖN Yön : Sol Ve Sağ Ağırlık : 0,03 kg / 0.066 lb Malzeme Türü : Rubber	823411313A*, 823411313A



\* Bu sayfada ve katalogdaki tüm araçların adları, markaları, modelleri, sembolleri, logoları, orijinal numaraları (oe) ve diğer üçüncü parti numaraları sadece referans amaçlı kullanılmaktadır.

**90**
**1989 - 1991**

Resim	Ürün Kodu ve Açıklaması	Detay	OEM
	<b>AU12008K</b> VİRAJ DEMİR LASTİĞİ SOL VE SAĞ RUBBER	Şasi (Ön / Arka) : ÖN Yön : Sol Ve Sağ Ağırlık : 0.06 kg / 0.132 lb Malzeme Türü : Rubber	823411313A*
	<b>VW12104</b> AMORTİSÖR TAKOZU SOL VE SAĞ AMORTİSOR TABLASI	Yön : Sol Ve Sağ Ağırlık : 0,257 kg / 0.567 lb Not : AMORTİSOR TABLASI	811412323C, 811412323D 8A0412323B, 8A0412323D
	<b>VW12104K</b> AMORTİSÖR TAKOZU SOL VE SAĞ 2 PCS	Yön : Sol Ve Sağ Ağırlık : 0.514 kg / 1.133 lb Not : 2 PCS	811412323C, 811412323D 8A0412323B, 8A0412323D
	<b>AU12009</b> MOTOR TAKOZU ÖN SOL VE SAĞ	Şasi (Ön / Arka) : ÖN Yön : Sol Ve Sağ Ağırlık : 0,464 kg / 1.023 lb	823199381B, 893199381B
	<b>AU12010</b> MOTOR TAKOZU ÖN SOL VE SAĞ ŞANZUMAN TAKOZU	Şasi (Ön / Arka) : ÖN Yön : Sol Ve Sağ Ağırlık : 0,4 kg / 0.882 lb Not : ŞANZUMAN TAKOZU	893399151A
	<b>AU12013</b> MOTOR TAKOZU ÖN SOL VE SAĞ VERS BURCU	Şasi (Ön / Arka) : ÖN Yön : Sol Ve Sağ Ağırlık : 0,129 kg / 0.284 lb Not : VERS BURCU	811199415A, 893199415
	<b>AU12014</b> MOTOR TAKOZU ÖN SOL VE SAĞ TRAVERS BURCU ARKA	Şasi (Ön / Arka) : ÖN Yön : Sol Ve Sağ Ağırlık : 0,118 kg / 0.260 lb Not : TRAVERS BURCU ARKA	811199419B, 811199419C 893199419
	<b>AU12011</b> ŞANZİMAN TAKOZU SOL VE SAĞ ŞANZUMAN TAKOZU	Şasi (Ön / Arka) : ÖN Yön : Sol Ve Sağ Ağırlık : 0,26 kg / 0.573 lb Not : ŞANZUMAN TAKOZU	811399151B
	<b>AU12034</b> ŞANZİMAN TAKOZU	Ağırlık : 0,556 kg / 1.226 lb	811199339A, 811199339B 823199339A
	<b>AU12012</b> EGSOZ TAKOZU ÖN SOL VE SAĞ EGSOZ LASTİĞİ	Şasi (Ön / Arka) : ÖN Yön : Sol Ve Sağ Ağırlık : 0.034 kg / 0.075 lb Not : EGSOZ LASTİĞİ	191253147B, 4A0253147A
	<b>OP14003</b> AKS KÖRÜĞÜ +KELEPÇE+YAĞ. AKS KÖRÜĞÜ DIŞ	Ağırlık : 0.2 kg / 0.441 lb	1603180

\* Bu sayfada ve katalogdaki tüm araçların adları, markaları, modelleri, sembolleri, logoları, orjinal numaraları (oe) ve diğer üçüncü parti numaraları sadece referans amaçlı kullanılmaktadır.

**90**
**1989 - 1991**

Resim	Ürün Kodu ve Açıklaması	Detay	OEM
	<b>RN14006</b> AKS KÖRÜĞÜ +KELEPÇE+YAĞ. DIŞ	Ağırlık : 0.2 kg / 0.441 lb	1603180, 1603204 16410170470106*, 16500170470106* 1H0498203, 271648 271649, 321498203A 431498203C, 443498203D
	<b>VW14013</b> AKS KÖRÜĞÜ +KELEPÇE+YAĞ. YAĞ+KELEPÇE	Ağırlık : 0.156 kg / 0.344 lb	113501149, 171407283A
	<b>VW14014</b> AKS KÖRÜĞÜ +KELEPÇE+YAĞ. YAĞ+KELEPÇE	Ağırlık : 0.28 kg / 0.617 lb	191498203C, 71498203

**90**
**1992 - 1994**







Resim	Ürün Kodu ve Açıklaması	Detay	OEM
	<b>AU1011</b> ROTİL ÖN SOL RB2524	Ağırlık : 0,565 kg / 1.246 lb Bağlantı Delik Çapı : Ø10,5	893.407.365B, 893.407.365D 893407365B, 893407365D 894407365E, 895407365 8A0.407.365, 8A0407365
	<b>AU1012</b> ROTİL ÖN SAĞ RB2525	Ağırlık : 0,565 kg / 1.246 lb Bağlantı Delik Çapı : Ø10,5	893407366B, 894407366E 895407366, 8A0.407.366 8A0407366
	<b>AU2311</b> ROTBAŞI ÖN SAĞ - SOL RB2311	Ağırlık : 0,218 kg / 0.481 lb Uzunluk : 75 mm / 2.95 inch Gövde Diş Çapı : M14X1,5 Aşık Diş Çapı : M10X1 Aşık Konik Çapı : Ø11	811419812A, 811419812B 8A0419812
	<b>AU4001</b> Z ROT SOL VE SAĞ METAL RB2911	Ağırlık : 0,357 kg / 0.787 lb Malzeme Türü : Metal Uzunluk : 270 mm / 10.63 inch Aşık Diş Çapı : M10X1,5	893407465, 893407465A 8A0407465, 8A0407465B 8A0407465C
	<b>AU4001A</b> Z ROT ÖN PLASTİK	Ağırlık : 0,295 kg / 0.650 lb Malzeme Türü : Plastik Uzunluk : 317 mm / 12.48 inch	893407465, 893407465A 8A0407465, 8A0407465B 8A0407465C
	<b>AU4003</b> Z ROT SAĞ RB2913	Ağırlık : 0,406 kg / 0.895 lb Uzunluk : 226,5 mm / 8.92 inch Aşık Diş Çapı : M10X1,5	8A0505466C, 8D0505466
	<b>AU4004</b> Z ROT SOL RB2914	Ağırlık : 0,404 kg / 0.891 lb Uzunluk : 226,5 mm / 8.92 inch Aşık Diş Çapı : M10X1,5	8A0505465C, 8D0505465

\* Bu sayfada ve katalogdaki tüm araçların adları, markaları, modelleri, sembolleri, logoları, orijinal numaraları (oe) ve diğer üçüncü parti numaraları sadece referans amaçlı kullanılmaktadır.





Resim	Ürün Kodu ve Açıklaması	Detay	OEM
	<b>AU6006</b> SALINCAK ÖN SAĞ	Ağırlık : 2,596 kg / 5.723 lb Malzeme Türü : Sac Metal	895407148A*, 895407148A
	<b>AU6006J</b> SALINCAK ÖN SAĞ RB3109	Ağırlık : 1,947 kg / 4.292 lb Malzeme Türü : Sac Metal	895407148A
	<b>AU6007</b> SALINCAK ÖN SOL	Ağırlık : 2,672 kg / 5.891 lb Malzeme Türü : Sac Metal	895407147A*, 895407147A
	<b>AU6007J</b> SALINCAK ÖN SOL RB3108	Ağırlık : 1,987 kg / 4.381 lb Malzeme Türü : Sac Metal	895407147A
	<b>AU11001</b> SALINCAK VE DENGE KOLU BURCU ÖN İÇ SOL VE SAĞ B22128	Şasi (Ön / Arka) : ÖN Yön : İç Sol Ve Sağ Ağırlık : 0,158 kg / 0.348 lb Not : L=44mm/İN D=Ø10,2mm/O D=Ø37,1m	857407181, 8A0407181
	<b>AU11030</b> SALINCAK VE DENGE KOLU BURCU SOL VE SAĞ	Yön : Sol Ve Sağ Ağırlık : 0,21 kg / 0.463 lb	893407181
	<b>AU11024</b> Z-ROT BURCU ARKA	Şasi (Ön / Arka) : ARKA Ağırlık : 0.55 kg / 1.213 lb Uzunluk : AU4003 mm / 0.00 inch Aşık Diş Çapı : AU4004	8A0505466C*, 8A0505466C* 8D0505465*, 8D0505466*
	<b>AU12002</b> BEŞİK (TRAVERS) BURCU ARKA SOL VE SAĞ	Şasi (Ön / Arka) : ARKA Yön : Sol Ve Sağ Ağırlık : 0.53 kg / 1.168 lb	8A0501541
	<b>VW12020</b> VİRAJ DEMİR LASTİĞİ SOL VE SAĞ RUBBER	Şasi (Ön / Arka) : ÖN Yön : Sol Ve Sağ Ağırlık : 0.07 kg / 0.154 lb Malzeme Türü : Rubber Not : VİRAJ ORTA LASTİĞİ	8D0511327C
	<b>VW12020K</b> VİRAJ DEMİR LASTİĞİ SOL VE SAĞ RUBBER	Şasi (Ön / Arka) : ÖN Yön : Sol Ve Sağ Ağırlık : 0.14 kg / 0.309 lb Malzeme Türü : Rubber	8D0511327C*
	<b>VW12104</b> AMORTİSÖR TAKOZU SOL VE SAĞ AMORTİSOR TABLASI	Yön : Sol Ve Sağ Ağırlık : 0,257 kg / 0.567 lb Not : AMORTİSOR TABLASI	811412323C, 811412323D 8A0412323B, 8A0412323D

\* Bu sayfada ve katalogdaki tüm araçların adları, markaları, modelleri, sembolleri, logoları, orijinal numaraları (oe) ve diğer üçüncü parti numaraları sadece referans amaçlı kullanılmaktadır.











**90**
**1992 - 1994**

Resim	Ürün Kodu ve Açıklaması	Detay	OEM
	<b>VW12104K</b> AMORTİSÖR TAKOZU SOL VE SAĞ 2 PCS	Yön : Sol Ve Sağ Ağırlık : 0.514 kg / 1.133 lb Not : 2 PCS	811412323C, 811412323D 8A0412323B, 8A0412323D
	<b>AU12013</b> MOTOR TAKOZU ÖN SOL VE SAĞ VERS BURCU	Şasi (Ön / Arka) : ÖN Yön : Sol Ve Sağ Ağırlık : 0,129 kg / 0.284 lb Not : VERS BURCU	811199415A, 893199415
	<b>AU12014</b> MOTOR TAKOZU ÖN SOL VE SAĞ TRAVERS BURCU ARKA	Şasi (Ön / Arka) : ÖN Yön : Sol Ve Sağ Ağırlık : 0,118 kg / 0.260 lb Not : TRAVERS BURCU ARKA	811199419B, 811199419C 893199419
	<b>RN14006</b> AKS KÖRÜĞÜ +KELEPÇE+YAĞ. DIŞ	Ağırlık : 0.2 kg / 0.441 lb	1603180, 1603204 16410170470106*, 16500170470106* 1H0498203, 271648 271649, 321498203A 431498203C, 443498203D
	<b>VW14001</b> AKS KÖRÜĞÜ +KELEPÇE+YAĞ. DIŞ	Ağırlık : 0.14 kg / 0.309 lb	441 407 203A, 441407203A
	<b>VW14013</b> AKS KÖRÜĞÜ +KELEPÇE+YAĞ. YAĞ+KELEPÇE	Ağırlık : 0.156 kg / 0.344 lb	113501149, 171407283A

**A1**
**8X**
**2010 - 2019**

Resim	Ürün Kodu ve Açıklaması	Detay	OEM
	<b>SK1025</b> ROTİL SAĞ	Ağırlık : 0,59 kg / 1.301 lb Konik Ölçüsü : Ø15 Bağlantı Delik Çapı : Ø10,5 Aşık Diş Çapı : M12X1,5	5U0407366A, 6R0407366 6R0407366A, 6R0407366B
	<b>SK1026</b> ROTİL ÖN ALT SOL Ø15	Ağırlık : 0,59 kg / 1.301 lb Konik Ölçüsü : Ø15 Bağlantı Delik Çapı : Ø10,5 Aşık Diş Çapı : M12X1,5	5U0407365A, 6R0407365 6R0407365A, 6R0407365B
	<b>AU2009</b> ROTBAŞI SAĞ UZUN RD0332	Ağırlık : 0,37 kg / 0.816 lb Uzunluk : 92 mm / 3.62 inch Gövde Diş Çapı : M14X1,5 Aşık Diş Çapı : M12X1,5 Aşık Konik Çapı : Ø13,3	1J0422812B, 3A0422812B 6R0423812A
	<b>AU2010</b> ROTBAŞI SOL RD0331	Ağırlık : 0,375 kg / 0.827 lb Uzunluk : 92 mm / 3.62 inch Gövde Diş Çapı : M14X1,5 Aşık Diş Çapı : M12X1,5 Aşık Konik Çapı : Ø13,2	1J0422811B, 1JD422811 3A0422811B, 6R0423811A



\* Bu sayfada ve katalogdaki tüm araçların adları, markaları, modelleri, sembolleri, logoları, orjinal numaraları (oe) ve diğer üçüncü parti numaraları sadece referans amaçlı kullanılmaktadır.

A1	8X	2010 - 2019	
Resim	Ürün Kodu ve Açıklaması	Detay	OEM
	<b>AU3012</b> ROTMİLİ SAĞ-SOL M14X1,5 L=312MM	Ağırlık : 0,6 kg / 1.323 lb Uzunluk : 312 mm / 12.28 inch Gövde Diş Çapı : M14X1,5 Aşık Diş Çapı : M14X1,5	6C0423810A, 6C0423810B 6C0423810C
	<b>VW3017</b> ROTMİLİ ÖN M14X1.5 313	Ağırlık : 0,6 kg / 1.323 lb Uzunluk : 313 mm / 12.32 inch Gövde Diş Çapı : M14X1,5 Aşık Diş Çapı : M14X1,5	6R0423803, 6R0423803C 6R0423804, 6R0423804B 6R0423804C, 6R0423810 8Z0419810C, 8Z0423803
	<b>AU2009VW3017</b> ROT TAKIMI ÖN AKS SAĞ	Ağırlık : 0,97 kg / 2.138 lb Rotbaşı : AU2009 Rotmili : VW3017	6R0423804B
	<b>AU2010VW3017</b> ROT TAKIMI SOL KOMPLE	Ağırlık : 0,97 kg / 2.138 lb Rotbaşı : AU2010 Rotmili : VW3017	6R0423803B
	<b>AU4028</b> Z ROT ÖN	Ağırlık : 0,368 kg / 0.811 lb Malzeme Türü : Metal Uzunluk : 270 mm / 10.63 inch Aşık Diş Çapı : M10X1,5	6Q0411315L, 6Q0411315N 8Z0411315D
	<b>AU9009</b> SALINCAK ALT SOL VE SAĞ	Ağırlık : 2,910 kg / 6.415 lb Malzeme Türü : Sac Metal	5Q0505311C, 5Q0505311D
	<b>AU9023</b> SALINCAK ARKA ALT ÖNDEN SAĞ	Ağırlık : 1,822 kg / 4.017 lb Malzeme Türü : Sac Metal	6R0505224
	<b>AU9024</b> SALINCAK ARKA ALT ÖNDEN SOL	Ağırlık : 1,822 kg / 4.017 lb Malzeme Türü : Sac Metal	6R0505223
	<b>VW6034</b> SALINCAK ÖN SAĞ	Ağırlık : 3,495 kg / 7.705 lb Malzeme Türü : Sac Metal	6R0407152A**, 6R0407152A 6R0407152B**, 6R0407152C** 6R0407152C, 6R0407152E 6R0407152F**
	<b>VW6034J</b> SALINCAK ÖN SAĞ	Ağırlık : 3 kg / 6.614 lb Malzeme Türü : Sac Metal	6R0407152A, 6R0407152B 6R0407152C, 6R0407152F
	<b>VW6035</b> SALINCAK ÖN SOL	Ağırlık : 3,495 kg / 7.705 lb Malzeme Türü : Sac Metal	6R0407151A**, 6R0407151A 6R0407151B**, 6R0407151C** 6R0407151C, 6R0407151E 6R0407151F**

\* Bu sayfada ve katalogdaki tüm araçların adları, markaları, modelleri, sembolleri, logoları, orjinal numaraları (oe) ve diğer üçüncü parti numaraları sadece referans amaçlı kullanılmaktadır.

A1	8X	2010 - 2019	
Resim	Ürün Kodu ve Açıklaması	Detay	OEM
	<b>VW6035J</b> SALINCAK ÖN SOL	Ağırlık : 3,5 kg / 7.716 lb Malzeme Türü : Sac Metal	6R0407151A, 6R0407151B 6R0407151C, 6R0407151F
	<b>AU11002</b> SALINCAK VE DENGE KOLU BURCU ÖN SOL VE SAĞ B22117	Şasi (Ön / Arka) : ÖN Yön : Sol Ve Sağ Ağırlık : 0,108 kg / 0.238 lb	1J0407181, 1J0407181A
	<b>AU11005</b> SALINCAK VE DENGE KOLU BURCU ÖN ORTA SOL VE SAĞ B40115	Şasi (Ön / Arka) : ÖN Yön : Orta Sol Ve Sağ Ağırlık : 0,111 kg / 0.245 lb Not : VW6014 - VW60614J	191407182, 357407182 357407182F
	<b>AU11052</b> SALINCAK VE DENGE KOLU BURCU SOL VE SAĞ	Yön : Sol Ve Sağ Ağırlık : 0,178 kg / 0.392 lb	1K0505541B, 1K0505541C 1K0505541D
	<b>AU11070</b> SALINCAK VE DENGE KOLU BURCU ARKA ALT	Şasi (Ön / Arka) : ARKA Yön : Alt Ağırlık : 0,100 kg / 0.220 lb	5Q0505171, 5Q0505311C 5Q0505311CSK, 5Q0505311D 5Q0505311DSK
	<b>AU11088</b> SALINCAK VE DENGE KOLU BURCU ARKA	Şasi (Ön / Arka) : ARKA Ağırlık : 0,165 kg / 0.364 lb	1K0505541C, 1K0505541D 3C0505541
	<b>VW11037</b> SALINCAK VE DENGE KOLU BURCU SOL VE SAĞ	Yön : Sol Ve Sağ Ağırlık : 0.11 kg / 0.243 lb	1K0505279A
	<b>VW12159</b> TAŞIYICI DESTEK BURÇLARI ARKA SOL VE SAĞ	Şasi (Ön / Arka) : ARKA Yön : Sol Ve Sağ Ağırlık : 0,130 kg / 0.287 lb	1K0505553, 1K0505553A
	<b>AU12024</b> TORSİYON BURCU ARKA SOL VE SAĞ	Şasi (Ön / Arka) : ARKA Yön : Sol Ve Sağ Ağırlık : 0.557 kg / 1.228 lb	1K0505145F, 1K0505145H 1K0505145K
	<b>VW12024</b> VİRAJ DEMİR LASTİĞİ SOL VE SAĞ RUBBER	Şasi (Ön / Arka) : ÖN Yön : Sol Ve Sağ Ağırlık : 0.03 kg / 0.066 lb Malzeme Türü : Rubber Not : VİRAJ LASTİĞİ	6Q0411303AA, 6Q0411303AD 6Q0411305H, 6Q0411314M 6Q0411314Q
	<b>VW12024K</b> VİRAJ DEMİR LASTİĞİ SOL VE SAĞ RUBBER	Şasi (Ön / Arka) : ÖN Yön : Sol Ve Sağ Ağırlık : 0.06 kg / 0.132 lb Malzeme Türü : Rubber Not : VİRAJ LASTİĞİ (İKİLİ)	6Q0411303AA*, 6Q0411303AA 6Q0411303AD*, 6Q0411303AD 6Q0411305H*, 6Q0411305H 6Q0411314M*, 6Q0411314M 6Q0411314Q*, 6Q0411314Q





\* Bu sayfada ve katalogdaki tüm araçların adları, markaları, modelleri, sembolleri, logoları, orjinal numaraları (oe) ve diğer üçüncü parti numaraları sadece referans amaçlı kullanılmaktadır.

A1	8X	2010 - 2019	
Resim	Ürün Kodu ve Açıklaması	Detay	OEM
	<b>SK12002</b> AMORTİSÖR TAKOZU ARKA SOL VE SAĞ 1.2 / 1.4TSI / 1.6TDI / 1.2TDI	Şasi (Ön / Arka) : ARKA Yön : Sol Ve Sağ Ağırlık : 0,305 kg / 0.672 lb Not : 1.2 / 1.4TSI / 1.6TDI / 1.2TDI	1J0513353A, 1J0513353B 1J0513353C, 1J0513353G 6QE513353, 6R0513353 6R0513353B
	<b>VW12061</b> AMORTİSÖR TAKOZU SOL VE SAĞ AMORTİSÖR TAKOZU	Yön : Sol Ve Sağ Ağırlık : 0.27 kg / 0.595 lb Not : AMORTİSÖR TAKOZU	1H0412365A, 1J0412249 1J0412331BS, 1J0412331C
	<b>VW12061A</b> AMORTİSÖR TAKOZU SOL VE SAĞ AMORTİSÖR RULMANI	Yön : Sol Ve Sağ Ağırlık : 0.08 kg / 0.176 lb Not : AMORTİSÖR RULMANI	1J0412249, 1J0412249C 357412249, 357412249A 4503300051, 7201688 7201848, 95VW3K031AA
	<b>VW12061K</b> AMORTİSÖR TAKOZU SOL VE SAĞ 2 PCS	Yön : Sol Ve Sağ Ağırlık : 0.7 kg / 1.543 lb Not : 2 PCS	1H0412365A, 1J0412249 1J0412331BS, 1J0412331C
	<b>VW12103</b> AMORTİSÖR TAKOZU SOL VE SAĞ AMORTİSÖR ÜST TAKOZU	Yön : Sol Ve Sağ Ağırlık : 0.23 kg / 0.507 lb Not : AMORTİSÖR ÜST TAKOZU	1J0412331B, 1J0412331C
	<b>SE12001</b> MOTOR TAKOZU ÖN SOL VE SAĞ	Şasi (Ön / Arka) : ÖN Yön : Sol Ve Sağ Ağırlık : 1,360 kg / 2.998 lb	6C0199851J
	<b>SE12004</b> MOTOR TAKOZU ÖN SOL VE SAĞ	Şasi (Ön / Arka) : ÖN Yön : Sol Ve Sağ Ağırlık : 1,300 kg / 2.866 lb	6C0199262A
	<b>VW12093</b> MOTOR TAKOZU SOL VE SAĞ MOTOR TAKOZU	Yön : Sol Ve Sağ Ağırlık : 1.05 kg / 2.315 lb Not : MOTOR TAKOZU	6Q0199851AC, 6Q0199851AL 6Q0199851AR, 6Q0199851E 6Q0199851S
	<b>VW12123</b> MOTOR TAKOZU SOL ŞANZUMAN TAKOZU	Yön : Sol Ağırlık : 1.642 kg / 3.620 lb Malzeme Türü : Şanzuman TakoZu	6Q0199555AE, 6Q0199555AT 6R0199555, 6RF199555A 6RF199555C
	<b>VW12036</b> SÜSPANSİYON TAKOZU SOL VE SAĞ ARKA SUSPANSİYON TAKOZU	Yön : Sol Ve Sağ Ağırlık : 1.591 kg / 3.508 lb Not : ARKA SUSPANSİYON TAKOZU	6Q0512131B
	<b>VW12038</b> SÜSPANSİYON TAKOZU SOL VE SAĞ SUS. ARA YATAK TAKOZ ARKA	Yön : Sol Ve Sağ Ağırlık : 0.12 kg / 0.265 lb Not : SUS. ARA YATAK TAKOZ ARKA	3C0 511 359, 3C0511359

\* Bu sayfada ve katalogdaki tüm araçların adları, markaları, modelleri, sembolleri, logoları, orijinal numaraları (oe) ve diğer üçüncü parti numaraları sadece referans amaçlı kullanılmaktadır.













**A1 8X 2010 - 2019**

Resim	Ürün Kodu ve Açıklaması	Detay	OEM
	<b>SK12006</b> EGZOZ TAKOZU	Ağırlık : 0,185 kg / 0.408 lb	6Q0253144B, 6Q0253144D
	<b>VW12086</b> RADYATÖR TAKOZU SOL VE SAĞ RADYATÖR ÜST LASTİĞİ	Yön : Sol Ve Sağ Ağırlık : 0.024 kg / 0.053 lb Not : RADYATÖR ÜST LASTİĞİ	1K0121367F
	<b>AU14001</b> AKS KÖRÜĞÜ +KELEPÇE+YAĞ.	Ağırlık : 0.233 kg / 0.514 lb	6Q0498203A
	<b>VW14003</b> AKS KÖRÜĞÜ +KELEPÇE+YAĞ. DIŞ	Ağırlık : 0.25 kg / 0.551 lb	1K0 498 203, 1K0498203

**A1 GBA 2018 -**

Resim	Ürün Kodu ve Açıklaması	Detay	OEM
	<b>VW1014</b> ROTİL ÖN ALT SAĞ Ø15,6 RB2536	Ağırlık : 0,565 kg / 1.246 lb Konik Ölçüsü : Ø15,6 Bağlantı Delik Çapı : Ø10,5 Aşık Diş Çapı : M12X1,5	1K0407366B, 1K0407366C 1K0407366E, 5Q0407366A
	<b>VW1015</b> ROTİL ÖN ALT SOL Ø15,6 RB2537	Ağırlık : 0,565 kg / 1.246 lb Konik Ölçüsü : Ø15,6 Bağlantı Delik Çapı : Ø10,5 Aşık Diş Çapı : M12X1,5	1K0407365B, 1K0407365C 1K0407365E, 5Q0407365A
	<b>VW2008</b> ROTBAŞI ÖN SAĞ RD0342	Ağırlık : 0,412 kg / 0.908 lb Uzunluk : 95 mm / 3.74 inch Gövde Diş Çapı : M16X1,5 Aşık Diş Çapı : M12X1,5 Aşık Konik Çapı : Ø12,7	1K0423812A, 1K0423812C 1K0423812E, 1K0423812G 1K0423812J, 1K0423812K 1KD423812A
	<b>VW2009</b> ROTBAŞI ÖN SOL RD0343	Ağırlık : 0,412 kg / 0.908 lb Uzunluk : 95 mm / 3.74 inch Gövde Diş Çapı : M16X1,5 Aşık Diş Çapı : M12X1,5 Aşık Konik Çapı : Ø13,5	1K0423811A, 1K0423811C 1K0423811E, 1K0423811G 1K0423811J, 1K0423811K 1KD423811A
	<b>VW3025</b> ROTMİLİ SOL VE SAĞ 311	Ağırlık : 0,676 kg / 1.490 lb Uzunluk : 311 mm / 12.24 inch Gövde Diş Çapı : M14X1,5 Aşık Diş Çapı : M16X1,5	2Q0423810D
	<b>SK4001</b> Z ROT ÖN METAL	Ağırlık : 0,357 kg / 0.787 lb Malzeme Türü : Metal Uzunluk : 270 mm / 10.63 inch Aşık Diş Çapı : M10X1,5	2Q0411315, 2Q0411315A 6Q0411315A, 6Q0411315E 6Q0411315F, 6Q0411315H 6Q0411315J, 6Q0411315M 6Q0411315P

\* Bu sayfada ve katalogdaki tüm araçların adları, markaları, modelleri, sembolleri, logoları, orjinal numaraları (oe) ve diğer üçüncü parti numaraları sadece referans amaçlı kullanılmaktadır.

A1	GBA		2018 -
Resim	Ürün Kodu ve Açıklaması	Detay	OEM
	<b>VW6063</b> SALINCAK ÖN ALT SAĞ	Ağırlık : 3,004 kg / 6.623 lb Malzeme Türü : Sac Metal	2Q0407152B
	<b>VW6063J</b> SALINCAK ÖN ALT SAĞ	Ağırlık : 2,439 kg / 5.377 lb Malzeme Türü : Sac Metal	2Q0407152B
	<b>VW6064</b> SALINCAK ÖN ALT SOL	Ağırlık : 3,004 kg / 6.623 lb Malzeme Türü : Sac Metal	2Q0407151B
	<b>VW6064J</b> SALINCAK ÖN ALT SOL	Ağırlık : 2,439 kg / 5.377 lb Malzeme Türü : Sac Metal	2Q0407151B
	<b>VW6065</b> SALINCAK ÖN ALT SAĞ	Ağırlık : 3,57 kg / 7.871 lb Malzeme Türü : Sac Metal	2Q0407152C
	<b>VW6065J</b> SALINCAK ÖN ALT SAĞ	Ağırlık : 2,964 kg / 6.535 lb Malzeme Türü : Sac Metal	2Q0407152C
	<b>VW6066</b> SALINCAK ÖN ALT SOL	Ağırlık : 3,57 kg / 7.871 lb Malzeme Türü : Sac Metal	2Q0407151C
	<b>VW6066J</b> SALINCAK ÖN ALT SOL	Ağırlık : 2,964 kg / 6.535 lb Malzeme Türü : Sac Metal	2Q0407151C
	<b>AU11005</b> SALINCAK VE DENGE KOLU BURCU ÖN ORTA SOL VE SAĞ B40115	Şasi (Ön / Arka) : ÖN Yön : Orta Sol Ve Sağ Ağırlık : 0,111 kg / 0.245 lb Not : VW6014 - VW60614J	191407182, 357407182 357407182F
	<b>AU12027</b> AMORTİSÖR TAKOZU ARKA ÜST SAĞ	Şasi (Ön / Arka) : ARKA Yön : Üst Sağ Ağırlık : 0,415 kg / 0.915 lb	5Q0513353H

A2	8Z0	2000 - 2005	
Resim	Ürün Kodu ve Açıklaması	Detay	OEM
	<b>SK2003</b> ROTBAŞI SAĞ RC7314	Ağırlık : 0,377 kg / 0.831 lb Uzunluk : 93,5 mm / 3.68 inch Gövde Diş Çapı : M14X1,5 Aşık Diş Çapı : M12X1,5 Aşık Konik Çapı : Ø13,5	5Z0423812, 6Q0419812C 6Q0423812, 6Q0423812A 6Q0423812C, 6Q0423812D 6R0423812, 8Z0423811A
	<b>SK2004</b> ROTBAŞI SOL RC7313	Ağırlık : 0,382 kg / 0.842 lb Uzunluk : 93 mm / 3.66 inch Gövde Diş Çapı : M14X1,5 Aşık Diş Çapı : M12X1,5 Aşık Konik Çapı : Ø13,5	5Z0423811, 6Q0419811C 6Q0423811, 6Q0423811A 6Q0423811C, 6Q0423811D 6R0423811, 8Z0423812A
	<b>AU3017</b> ROTMİLİ 330	Ağırlık : 0,610 kg / 1.345 lb Uzunluk : 330 mm / 12.99 inch	8Z0423803F*, 8Z0423804F*
	<b>VW3017</b> ROTMİLİ ÖN M14X1.5 313	Ağırlık : 0,6 kg / 1.323 lb Uzunluk : 313 mm / 12.32 inch Gövde Diş Çapı : M14X1,5 Aşık Diş Çapı : M14X1,5	6R0423803, 6R0423803C 6R0423804, 6R0423804B 6R0423804C, 6R0423810 8Z0419810C, 8Z0423803
	<b>SK2003VW3017</b> ROT TAKIMI ÖN AKS SAĞ	Ağırlık : 1,008 kg / 2.222 lb Rotbaşı : SK2003 Rotmilî : VW3017	6R0423804, 6R0423804A 8Z0423804C
	<b>SK2004VW3017</b> ROT TAKIMI ÖN AKS SOL	Ağırlık : 1,008 kg / 2.222 lb Rotbaşı : SK2004 Rotmilî : VW3017	6R0423803, 6R0423803A 8Z0423803C, SK-402923
	<b>AU4027</b> RIW Z ROT ÖN	Ağırlık : 0,176 kg / 0.388 lb Uzunluk : 58,5 mm / 2.30 inch Aşık Diş Çapı : M10X1,5	8Z0411315B, 8Z0411315C
	<b>AU4028</b> Z ROT ÖN	Ağırlık : 0,368 kg / 0.811 lb Malzeme Türü : Metal Uzunluk : 270 mm / 10.63 inch Aşık Diş Çapı : M10X1,5	6Q0411315L, 6Q0411315N 8Z0411315D
	<b>AU6013</b> SALINCAK ÖN ALT SAĞ	Malzeme Türü : Alüminyum	8Z0407152R, 8Z0407152S
	<b>AU6013A</b> SALINCAK ÖN ALT SAĞ	Malzeme Türü : Döküm Çelik	8Z0407152J, 8Z0407152R 8Z0407152S
	<b>AU6014</b> SALINCAK ÖN ALT SOL	Malzeme Türü : Alüminyum	8Z0407151R, 8Z0407151S







\* Bu sayfada ve katalogdaki tüm araçların adları, markaları, modelleri, sembolleri, logoları, orjinal numaraları (oe) ve diğer üçüncü parti numaraları sadece referans amaçlı kullanılmaktadır.

**A2 8Z0 2000 - 2005**

Resim	Ürün Kodu ve Açıklaması	Detay	OEM
	<b>AU6014A</b> SALINCAK ÖN ALT SOL	Malzeme Türü : Döküm Çelik	8Z0407151J, 8Z0407151R 8Z0407151S
	<b>AU11069</b> SALINCAK VE DENGE KOLU BURCU ÖN ALT SOL VE SAĞ	Şasi (Ön / Arka) : ÖN Yön : Alt Sol Ve Sağ Ağırlık : 0.194 kg / 0.428 lb	6LL407183, 8Z0407183 8Z0407183A
	<b>VW12049</b> VİRAJ DEMİR LASTİĞİ SOL VE SAĞ RUBBER	Şasi (Ön / Arka) : ÖN Yön : Sol Ve Sağ Ağırlık : 0.03 kg / 0.066 lb Malzeme Türü : Rubber Not : VİRAJ LASTİĞİ	8Z0411314B
	<b>VW12049K</b> VİRAJ DEMİR LASTİĞİ SOL VE SAĞ RUBBER	Şasi (Ön / Arka) : ÖN Yön : Sol Ve Sağ Ağırlık : 0.06 kg / 0.132 lb Malzeme Türü : Rubber	8Z0411314B*
	<b>VW12050</b> VİRAJ DEMİR LASTİĞİ SOL VE SAĞ RUBBER	Şasi (Ön / Arka) : ÖN Yön : Sol Ve Sağ Ağırlık : 0.04 kg / 0.088 lb Malzeme Türü : Rubber Not : VİRAJ LASTİĞİ	6Q0411314P
	<b>VW12050K</b> VİRAJ DEMİR LASTİĞİ SOL VE SAĞ RUBBER	Şasi (Ön / Arka) : ÖN Yön : Sol Ve Sağ Ağırlık : 0.08 kg / 0.176 lb Malzeme Türü : Rubber Not : VİRAJ LASTİĞİ (İKİLİ)	6Q0411314P*, 6Q0411314P
	<b>SK12002</b> AMORTİSÖR TAKOZU ARKA SOL VE SAĞ 1.2 / 1.4TSI / 1.6TDI / 1.2TDI	Şasi (Ön / Arka) : ARKA Yön : Sol Ve Sağ Ağırlık : 0.305 kg / 0.672 lb Not : 1.2 / 1.4TSI / 1.6TDI / 1.2TDI	1J0513353A, 1J0513353B 1J0513353C, 1J0513353G 6QE513353, 6R0513353 6R0513353B
	<b>VW12109</b> AMORTİSÖR TAKOZU SOL VE SAĞ AMORTİSÖR RULMANI	Yön : Sol Ve Sağ Ağırlık : 0.26 kg / 0.573 lb Not : AMORTİSÖR RULMANI	6N0412249C, 6N0412249E
	<b>VW12109K</b> AMORTİSÖR TAKOZU SOL VE SAĞ 2 PCS	Yön : Sol Ve Sağ Ağırlık : 0.52 kg / 1.146 lb Not : 2 PCS	6N0412249C, 6N0412249E
	<b>VW12115</b> AMORTİSÖR TAKOZU SOL VE SAĞ AMORTİSÖR TAKOZU	Yön : Sol Ve Sağ Ağırlık : 0.85 kg / 1.874 lb Not : AMORTİSÖR TAKOZU	6N0412331D, 6N0412331E 6Q0412331B
	<b>VW12801</b> AMORTİSÖR TAKOZU SOL VE SAĞ KIT = VW12115 AND VW12109	Yön : Sol Ve Sağ Ağırlık : 1.269 kg / 2.798 lb Not : KIT = VW12115 and VW12109	6N0412249C, 6N0412249E 6N0412331D, 6N0412331E 6Q0412331B

\* Bu sayfada ve katalogdaki tüm araçların adları, markaları, modelleri, sembolleri, logoları, orjinal numaraları (oe) ve diğer üçüncü parti numaraları sadece referans amaçlı kullanılmaktadır.

**A2 8Z0 2000 - 2005**

Resim	Ürün Kodu ve Açıklaması	Detay	OEM
	<b>VW12036</b> SÜSPANSİYON TAKOZU SOL VE SAĞ ARKA SUSPANSİYON TAKOZU	Yön : Sol Ve Sağ Ağırlık : 1.591 kg / 3.508 lb Not : ARKA SUSPANSİYON TAKOZU	6Q0512131B
	<b>VW13007</b> DİREKSİYON KÖRÜĞÜ	Ağırlık : 0.128 kg / 0.282 lb	6N0422831
	<b>AU14001</b> AKS KÖRÜĞÜ +KELEPÇE+YAĞ.	Ağırlık : 0.233 kg / 0.514 lb	6Q0498203A
	<b>F114014</b> AKS KÖRÜĞÜ +KELEPÇE+YAĞ. DIŞ	Ağırlık : 0.211 kg / 0.465 lb	46307841
	<b>VW14009</b> AKS KÖRÜĞÜ +KELEPÇE+YAĞ. DIŞ	Ağırlık : 0.16 kg / 0.353 lb	1H0407285B
	<b>AU15001</b> AMORTİSÖR KÖRÜĞÜ ÖN	Şasi (Ön / Arka) : ÖN Ağırlık : 0,110 kg / 0.243 lb	6N0413175A
	<b>VW15002</b> AMORTİSÖR KÖRÜĞÜ ARKA	Şasi (Ön / Arka) : ARKA	900064

**A3 8L1 1996 - 2003**

Resim	Ürün Kodu ve Açıklaması	Detay	OEM
	<b>AU1013</b> ROTİL ÖN ALT SAĞ - SOL Ø15,5 RB2535	Ağırlık : 0,555 kg / 1.224 lb Konik Ölçüsü : Ø15,5 Bağlantı Delik Çapı : Ø10,7 Aşık Diş Çapı : M12X1,5	8N0.407.365A, 8N0.407.365B 8N0.407.365C, 8N0407365A 8N0407365B, 8N0407365C
	<b>AU1014</b> ROTİL ALT SAĞ Ø15	Ağırlık : 0,35 kg / 0.772 lb Konik Ölçüsü : Ø15 Bağlantı Delik Çapı : Ø8,5 Aşık Diş Çapı : M12X1,25	1J0407366A, 1J0407366AS 1J0407366B, 1J0407366C 1J0407366D, 1J0407366H
	<b>AU1014K</b> ROTİL ÖN SAĞ Ø15 RB2530	Ağırlık : 0,5 kg / 1.102 lb Konik Ölçüsü : Ø15 Bağlantı Delik Çapı : Ø8,5 Aşık Diş Çapı : M12X1,25	1J0407366, 1J0407366A 1J0407366AS, 1J0407366B 1J0407366C, 1J0407366CS 1J0407366D*, 1J0407366D 1J0407366H, 8Z0407366A

\* Bu sayfada ve katalogdaki tüm araçların adları, markaları, modelleri, sembolleri, logoları, orjinal numaraları (oe) ve diğer üçüncü parti numaraları sadece referans amaçlı kullanılmaktadır.

**A3 8L1 1996 - 2003**

Resim	Ürün Kodu ve Açıklaması	Detay	OEM
	<b>AU1015</b> ROTİL SOL	Ağırlık : 0,35 kg / 0.772 lb Konik Ölçüsü : Ø15 Bağlantı Delik Çapı : Ø8,5 Aşık Dış Çapı : M12X1,25	1J0407365A, 1J0407365B 1J0407365C, 1J0407365D
	<b>AU1015K</b> ROTİL ÖN SOL Ø15 RB2529	Ağırlık : 0,5 kg / 1.102 lb Konik Ölçüsü : Ø15 Bağlantı Delik Çapı : Ø8,5 Aşık Dış Çapı : M12X1,25	1J0407365, 1J0407365A* 1J0407365A, 1J0407365AS 1J0407365B*, 1J0407365B 1J0407365C*, 1J0407365C 1J0407365CS, 1J0407365D*
	<b>AU2009</b> ROTBAŞI SAĞ UZUN RD0332	Ağırlık : 0,37 kg / 0.816 lb Uzunluk : 92 mm / 3.62 inch Gövde Dış Çapı : M14X1,5 Aşık Dış Çapı : M12X1,5 Aşık Konik Çapı : Ø13,3	1J0422812B, 3A0422812B 6R0423812A
	<b>AU2010</b> ROTBAŞI SOL RD0331	Ağırlık : 0,375 kg / 0.827 lb Uzunluk : 92 mm / 3.62 inch Gövde Dış Çapı : M14X1,5 Aşık Dış Çapı : M12X1,5 Aşık Konik Çapı : Ø13,2	1J0422811B, 1JD422811 3A0422811B, 6R0423811A
	<b>AU2318</b> ROTBAŞI SOL KISA RB2318	Ağırlık : 0,312 kg / 0.688 lb Uzunluk : 76 mm / 2.99 inch Gövde Dış Çapı : M14X1,5 Aşık Dış Çapı : M12X1,5 Aşık Konik Çapı : Ø13,4	1J0422811, 1J0422811A
	<b>AU2319</b> ROTBAŞI SAĞ KISA RB2319	Ağırlık : 0,315 kg / 0.694 lb Uzunluk : 76 mm / 2.99 inch Gövde Dış Çapı : M14X1,5 Aşık Dış Çapı : M12X1,5 Aşık Konik Çapı : Ø13,4	1J0422812, 1J0422812A
	<b>AU3001</b> ROTMİLİ SOL VE SAĞ 318 RD0908	Ağırlık : 0,622 kg / 1.371 lb Uzunluk : 318 mm / 12.52 inch Gövde Dış Çapı : M16X1,5 Aşık Dış Çapı : M14X1,5	1J0422803B, 1J0422804B 1J0422804E, 1J0422807 1J0422807B, 1J0422821B
	<b>AU3003</b> ROTMİLİ SAĞ-SOL UZUN L 360 MM RB2811	Ağırlık : 0,629 kg / 1.387 lb Uzunluk : 341 mm / 13.43 inch Gövde Dış Çapı : M16X1,5 Aşık Dış Çapı : M14X1,5	1J0422803A, 1J0422804A 1J0422807A, 1J0422807C 1J0422821, 1J0422821A 1J0822807B
	<b>AU3004</b> ROTMİLİ	Ağırlık : 0.35 kg / 0.772 lb Uzunluk : 320 mm / 12.60 inch	1J0422810B

\* Bu sayfada ve katalogdaki tüm araçların adları, markaları, modelleri, sembolleri, logoları, orjinal numaraları (oe) ve diğer üçüncü parti numaraları sadece referans amaçlı kullanılmaktadır.

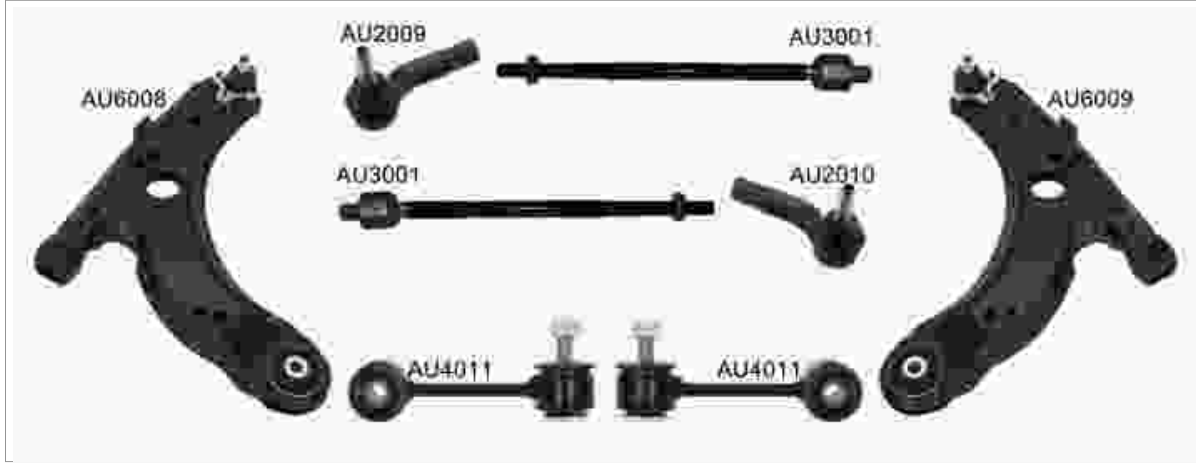
**VW8001 / Süspansiyon Kit Ön**
**A3**
**8L1**
**1996 - 2003**

**Kit Parçaları**

Resim	Ürün Kodu / Adı	OEM	OEM	Ürün Kodu / Adı	Resim
	<b>AU2009</b> Rotbaşı Sağ Uzun Rd0332	1J0422812B, 3A0422812B 6R0423812A	1J0422811B, 1JD422811 3A0422811B, 6R0423811A	<b>AU2010</b> Rotbaşı Sol Rd0331	
	<b>AU3001</b> Rotmili Sol Ve Sağ 318 Rd0908	1J0422803B, 1J0422804B 1J0422804E, 1J0422807 1J0422807B, 1J0422821B	1J0411315E, 1J0411315G 1J0422315G	<b>VW4011</b> Z Rot Ön Sağ-sol Metal 105 Rd0916	
	<b>AU6008</b> Salıncak Ön Sağ Rb3011	1J0407151B	1J0407151A	<b>AU6009</b> Salıncak Ön Sol Rb3012	

**VW8003 / Süspansiyon Kit Ön**

**A3**

**8L1**

**1996 - 2003**













**Kit Parçaları**

Resim	Ürün Kodu / Adı	OEM	OEM	Ürün Kodu / Adı	Resim
	<b>AU1014</b> Rotil Alt Sağ Ø15	1J0407366A, 1J0407366AS 1J0407366B, 1J0407366C 1J0407366D, 1J0407366H	1J0407365A, 1J0407365B 1J0407365C, 1J0407365D	<b>AU1015</b> Rotil Sol	
	<b>AU11002</b> Salıncak Ve Denge Kolu Burcu Ön Sol Ve Sağ B22117	1J0407181, 1J0407181A	191407182, 357407182 357407182F	<b>AU11005</b> Salıncak Ve Denge Kolu Burcu Ön Orta Sol Ve Sağ B40115	
	<b>VW4011</b> Z Rot Ön Sağ-sol Metal 105 Rd0916	1J0411315E, 1J0411315G 1J0422315G			



**A3 8L1 1996 - 2003**

Resim	Ürün Kodu ve Açıklaması	Detay	OEM
	<b>AU20093001</b> ROT TAKIMI SAĞ	Ağırlık : 0,951 kg / 2.097 lb Rotbaşı : AU2009 Rotmili : AU3001	1H0422804B
	<b>AU20103001</b> ROT TAKIMI SOL	Ağırlık : 0,952 kg / 2.099 lb Rotbaşı : AU2010 Rotmili : AU3001	1H0422803B
	<b>AU23183003</b> ROT TAKIMI SAĞ RB288113	Ağırlık : 0,945 kg / 2.083 lb Rotbaşı : AU2318 Rotmili : AU3003	1J0422804, 1J0422804A 1J0422804C
	<b>AU23183004</b> ROT TAKIMI SOL RD088206	Ağırlık : 1,075 kg / 2.370 lb Rotbaşı : AU2318 Rotmili : AU3004	1J0422803B
	<b>AU23193003</b> ROT TAKIMI SOL RB288112	Ağırlık : 0,94 kg / 2.072 lb Rotbaşı : AU2319 Rotmili : AU3003	1J0422803, 1J0422803A 1J0422803C
	<b>AU23193004</b> ROT TAKIMI SAĞ RD088207	Ağırlık : 1,1 kg / 2.425 lb Rotbaşı : AU2319 Rotmili : AU3004	1J0422804B
	<b>AU4005</b> Z ROT ÖN SOL METAL RB2924	Ağırlık : 0,602 kg / 1.327 lb Malzeme Türü : Metal Uzunluk : 335 mm / 13.19 inch Aşık Diş Çapı : M12X1,5	1J0411315D, 1J0411615D
	<b>AU4006</b> Z ROT ÖN SAĞ METAL RB2923	Ağırlık : 0,282 kg / 0.622 lb Malzeme Türü : Metal Uzunluk : 335 mm / 13.19 inch Aşık Diş Çapı : M12X1,5	1J0411316D
	<b>AU4021</b> Z ROT SOL VE SAĞ METAL RB2940	Ağırlık : 0,26 kg / 0.573 lb Malzeme Türü : Metal Uzunluk : 175 mm / 6.89 inch Aşık Diş Çapı : M10X1,5	1J0505466, 1J0505466B 1J0505466C
	<b>VW4010</b> Z ROT SOL VE SAĞ PLASTİK RD0924	Ağırlık : 0,18 kg / 0.397 lb Malzeme Türü : Plastik Uzunluk : 106 mm / 4.17 inch Aşık Diş Çapı : M10X1,5	1J0411315C, 1J0411315J
	<b>VW4011</b> Z ROT ÖN SAĞ-SOL METAL 105 RD0916	Ağırlık : 0,258 kg / 0.569 lb Malzeme Türü : Metal Uzunluk : 106 mm / 4.17 inch Aşık Diş Çapı : M10X1,5	1J0411315E, 1J0411315G 1J0422315G

\* Bu sayfada ve katalogdaki tüm araçların adları, markaları, modelleri, sembolleri, logoları, orjinal numaraları (oe) ve diğer üçüncü parti numaraları sadece referans amaçlı kullanılmaktadır.

**A3 8L1 1996 - 2003**

Resim	Ürün Kodu ve Açıklaması	Detay	OEM
	<b>AU5014</b> SALINCAK ARKA RB2625	Malzeme Türü : Alüminyum	4D0.407.505D, 4D0.407.505F 4D0407505A, 4D0407505B 4D0407505D, 4D0407505F 4D0407505H
	<b>AU6008</b> SALINCAK ÖN SAĞ RB3011	Ağırlık : 3,495 kg / 7.705 lb Malzeme Türü : Sac Metal	1J0407151B
	<b>AU6008J</b> SALINCAK ÖN SAĞ RB3101	Ağırlık : 3,212 kg / 7.081 lb Malzeme Türü : Sac Metal	1J0407151C
	<b>AU6009</b> SALINCAK ÖN SOL RB3012	Ağırlık : 3,495 kg / 7.705 lb Malzeme Türü : Sac Metal	1J0407151A
	<b>SE9003</b> SALINCAK ALT VE ÜST SOL VE SAĞ	Ağırlık : 1,080 kg / 2.381 lb Malzeme Türü : Sac Metal	1J0505323H, 1J0505323J 1J0505323L, 1J0505323M 1J0505323N
	<b>VW9001</b> SALINCAK ARKA	Ağırlık : 2,55 kg / 5.622 lb Malzeme Türü : Sac Metal	1K0505311AA, 1K0505311ABÂ 1K0505311H, 1K0505311S 1K0505311T
	<b>AU11002</b> SALINCAK VE DENGELİ KÖLÜ BURCU ÖN SOL VE SAĞ B22117	Şasi (Ön / Arka) : ÖN Yön : Sol Ve Sağ Ağırlık : 0,108 kg / 0.238 lb	1J0407181, 1J0407181A
	<b>AU11005</b> SALINCAK VE DENGELİ KÖLÜ BURCU ÖN ORTA SOL VE SAĞ B40115	Şasi (Ön / Arka) : ÖN Yön : Orta Sol Ve Sağ Ağırlık : 0,111 kg / 0.245 lb Not : VW6014 - VW60614J	191407182, 357407182 357407182F
	<b>AU11012</b> SALINCAK VE DENGELİ KÖLÜ BURCU ÖN SOL VE SAĞ B22116	Şasi (Ön / Arka) : ÖN Yön : Sol Ve Sağ Ağırlık : 0,188 kg / 0.414 lb	4D0407516A, 4D0407516C
	<b>AU11035</b> SALINCAK VE DENGELİ KÖLÜ BURCU ARKA SOL VE SAĞ	Şasi (Ön / Arka) : ARKA Yön : Sol Ve Sağ Ağırlık : 0,25 kg / 0.551 lb	1K0505171C
	<b>AU11023</b> Z-ROT BURCU ARKA	Şasi (Ön / Arka) : ARKA Ağırlık : 0.26 kg / 0.573 lb Uzunluk : AU4021 mm / 0.00 inch Aşık Diş Çapı : VW4017	1J0505466B*

\* Bu sayfada ve katalogdaki tüm araçların adları, markaları, modelleri, sembolleri, logoları, orijinal numaraları (oe) ve diğer üçüncü parti numaraları sadece referans amaçlı kullanılmaktadır.

**A3 8L1 1996 - 2003**

Resim	Ürün Kodu ve Açıklaması	Detay	OEM
	<b>VW11090</b> Z-ROT BURCU ÖN	Şasi (Ön / Arka) : ÖN Ağırlık : 0,045 kg / 0.099 lb	1J0411315*, 1J0411315B* 1J0411315C*, 1J0411315E* 1J0411315G*, 1J0411315J*
	<b>VW11008</b> TAŞIYICI DESTEK BURÇLARI SOL VE SAĞ	Yön : Sol Ve Sağ Ağırlık : 0.24 kg / 0.529 lb	1J0505203, 1J0505365D 1J0505365F, 1J0505365G 1J0505365J, 1J0505365K 1J0505365M, 1J0505365N
	<b>VW12010</b> TORSİYON BURCU SOL VE SAĞ	Yön : Sol Ve Sağ Ağırlık : 0.31 kg / 0.683 lb	1J0500045, 1J0500045A 1J0501541B, 1J0501541C 6R0501541A, 6R0501541B
	<b>VW12066</b> TORSİYON BURCU SOL VE SAĞ	Yön : Sol Ve Sağ Ağırlık : 0.6 kg / 1.323 lb	1J0 501 541 D, 1J0501541D
	<b>VW12016</b> VİRAJ DEMİR LASTİĞİ SOL VE SAĞ RUBBER	Şasi (Ön / Arka) : ÖN Yön : Sol Ve Sağ Ağırlık : 0.03 kg / 0.066 lb Malzeme Türü : Rubber	1J0411314G, 1J0411314T 8N0411303G, 8N0411303H
	<b>VW12016K</b> VİRAJ DEMİR LASTİĞİ SOL VE SAĞ RUBBER	Şasi (Ön / Arka) : ÖN Yön : Sol Ve Sağ Ağırlık : 0.06 kg / 0.132 lb Malzeme Türü : Rubber Not : İKİLİ	1J0411314G, 1J0411314T 8N0411303G, 8N0411303H
	<b>VW12020</b> VİRAJ DEMİR LASTİĞİ SOL VE SAĞ RUBBER	Şasi (Ön / Arka) : ÖN Yön : Sol Ve Sağ Ağırlık : 0.07 kg / 0.154 lb Malzeme Türü : Rubber Not : VİRAJ ORTA LASTİĞİ	8D0511327C
	<b>VW12020K</b> VİRAJ DEMİR LASTİĞİ SOL VE SAĞ RUBBER	Şasi (Ön / Arka) : ÖN Yön : Sol Ve Sağ Ağırlık : 0.14 kg / 0.309 lb Malzeme Türü : Rubber	8D0511327C*
	<b>VW12047</b> VİRAJ DEMİR LASTİĞİ SOL VE SAĞ RUBBER	Şasi (Ön / Arka) : ÖN Yön : Sol Ve Sağ Ağırlık : 0.14 kg / 0.309 lb Malzeme Türü : Rubber Not : VİRAJ LASTİĞİ	1J0411314B, 1J0411314S
	<b>VW12047K</b> VİRAJ DEMİR LASTİĞİ SOL VE SAĞ RUBBER	Şasi (Ön / Arka) : ÖN Yön : Sol Ve Sağ Ağırlık : 0.28 kg / 0.617 lb Malzeme Türü : Rubber Not : VİRAJ LASTİĞİ ( 2 ADET)	1J0411314B*, 1J0411314B 1J0411314S*, 1J0411314S
	<b>VW12048</b> VİRAJ DEMİR LASTİĞİ SOL VE SAĞ RUBBER	Şasi (Ön / Arka) : ÖN Yön : Sol Ve Sağ Ağırlık : 0.03 kg / 0.066 lb Malzeme Türü : Rubber Not : VİRAJ LASTİĞİ	1J0411314P

\* Bu sayfada ve katalogdaki tüm araçların adları, markaları, modelleri, sembolleri, logoları, orijinal numaraları (oe) ve diğer üçüncü parti numaraları sadece referans amaçlı kullanılmaktadır.

**A3**
**8L1**
**1996 - 2003**

Resim	Ürün Kodu ve Açıklaması	Detay	OEM
	<b>VW12048K</b> VİRAJ DEMİR LASTİĞİ SOL VE SAĞ RUBBER	Şasi (Ön / Arka) : ÖN Yön : Sol Ve Sağ Ağırlık : 0.06 kg / 0.132 lb Malzeme Türü : Rubber	1J0411314P*
	<b>VW12052</b> VİRAJ DEMİR LASTİĞİ SOL VE SAĞ RUBBER	Şasi (Ön / Arka) : ÖN Yön : Sol Ve Sağ Ağırlık : 0.06 kg / 0.132 lb Malzeme Türü : Rubber Not : VİRAJ LASTİĞİ	1J0411314R
	<b>VW12052K</b> VİRAJ DEMİR LASTİĞİ SOL VE SAĞ RUBBER	Şasi (Ön / Arka) : ÖN Yön : Sol Ve Sağ Ağırlık : 0.12 kg / 0.265 lb Malzeme Türü : Rubber	1J0411314R*
	<b>VW12064</b> VİRAJ DEMİR LASTİĞİ SOL VE SAĞ RUBBER	Şasi (Ön / Arka) : ÖN Yön : Sol Ve Sağ Ağırlık : 0,023 kg / 0.051 lb Malzeme Türü : Rubber Not : D=Ø21mm	1J0411314C, 1J0411314R
	<b>VW12064K</b> VİRAJ DEMİR LASTİĞİ SOL VE SAĞ RUBBER	Şasi (Ön / Arka) : ÖN Yön : Sol Ve Sağ Ağırlık : 0.046 kg / 0.101 lb Malzeme Türü : Rubber	1J0411314C*
	<b>VW12117</b> VİRAJ DEMİR LASTİĞİ SOL VE SAĞ RUBBER	Şasi (Ön / Arka) : ÖN Yön : Sol Ve Sağ Ağırlık : 0.08 kg / 0.176 lb Malzeme Türü : Rubber	1J0411327
	<b>VW12117K</b> VİRAJ DEMİR LASTİĞİ SOL VE SAĞ RUBBER	Şasi (Ön / Arka) : ÖN Yön : Sol Ve Sağ Ağırlık : 0.16 kg / 0.353 lb Malzeme Türü : Rubber	1J0411327
	<b>SK12002</b> AMORTİSÖR TAKOZU ARKA SOL VE SAĞ 1.2 / 1.4TSI / 1.6TDI / 1.2TDI	Şasi (Ön / Arka) : ARKA Yön : Sol Ve Sağ Ağırlık : 0,305 kg / 0.672 lb Not : 1.2 / 1.4TSI / 1.6TDI / 1.2TDI	1J0513353A, 1J0513353B 1J0513353C, 1J0513353G 6QE513353, 6R0513353 6R0513353B
	<b>VW12061</b> AMORTİSÖR TAKOZU SOL VE SAĞ AMORTİSÖR TAKOZU	Yön : Sol Ve Sağ Ağırlık : 0.27 kg / 0.595 lb Not : AMORTİSÖR TAKOZU	1H0412365A, 1J0412249 1J0412331BS, 1J0412331C
	<b>VW12061A</b> AMORTİSÖR TAKOZU SOL VE SAĞ AMORTİSOR RULMANI	Yön : Sol Ve Sağ Ağırlık : 0.08 kg / 0.176 lb Not : AMORTİSOR RULMANI	1J0412249, 1J0412249C 357412249, 357412249A 4503300051, 7201688 7201848, 95VW3K031AA
	<b>VW12061K</b> AMORTİSÖR TAKOZU SOL VE SAĞ 2 PCS	Yön : Sol Ve Sağ Ağırlık : 0.7 kg / 1.543 lb Not : 2 PCS	1H0412365A, 1J0412249 1J0412331BS, 1J0412331C





\* Bu sayfada ve katalogdaki tüm araçların adları, markaları, modelleri, sembolleri, logoları, orjinal numaraları (oe) ve diğer üçüncü parti numaraları sadece referans amaçlı kullanılmaktadır.

**A3 8L1 1996 - 2003**





Resim	Ürün Kodu ve Açıklaması	Detay	OEM
	<b>VW12103</b> AMORTİSÖR TAKOZU SOL VE SAĞ AMORTİSÖR ÜST TAKOZU	Yön : Sol Ve Sağ Ağırlık : 0.23 kg / 0.507 lb Not : AMORTİSÖR ÜST TAKOZU	1J0412331B, 1J0412331C
	<b>VW12030</b> MOTOR TAKOZU SOL VE SAĞ MOTOR TAKOZU ARKA	Yön : Sol Ve Sağ Ağırlık : 1.15 kg / 2.535 lb Not : MOTOR TAKOZU ARKA	1J0199851, 1J0199851AK
	<b>VW12040</b> MOTOR TAKOZU SOL VE SAĞ MOTOR TAKOZU	Yön : Sol Ve Sağ Ağırlık : 1.641 kg / 3.618 lb Not : MOTOR TAKOZU	1J0199555AA, 1J0199555AK
	<b>VW12070</b> MOTOR TAKOZU SOL VE SAĞ MOTOR TAKOZU	Yön : Sol Ve Sağ Ağırlık : 1.64 kg / 3.616 lb Not : MOTOR TAKOZU	1J0199555AH
	<b>VW12075</b> MOTOR TAKOZU SOL VE SAĞ MOTOR TAKOZU	Yön : Sol Ve Sağ Ağırlık : 2.2 kg / 4.850 lb Not : MOTOR TAKOZU	1J0199262BF
	<b>VW12084</b> MOTOR TAKOZU SOL VE SAĞ MOTOR TAKOZU	Yön : Sol Ve Sağ Ağırlık : 2.034 kg / 4.484 lb Not : MOTOR TAKOZU	1J0199262BE
	<b>VW12085</b> MOTOR TAKOZU SOL VE SAĞ EGZOS TAKOZU	Yön : Sol Ve Sağ Ağırlık : 0.1 kg / 0.220 lb Not : EGZOS TAKOZU	1J0253144G, 1J0802117
	<b>VW12100</b> MOTOR TAKOZU SOL VE SAĞ MOTOR TAKOZU ARKA	Yön : Sol Ve Sağ Ağırlık : 1.12 kg / 2.469 lb Not : MOTOR TAKOZU ARKA	1J0199851AA, 1J0199851AK 1J0199851M, 1J0199851N
	<b>VW12102</b> MOTOR TAKOZU SOL VE SAĞ MOTOR TAKOZU	Yön : Sol Ve Sağ Ağırlık : 1.64 kg / 3.616 lb Not : MOTOR TAKOZU	1J0199555AJ, 1J0199555AM 1J0199555AQ, 1J0199555BH
	<b>VW12096</b> SÜSPANSİYON TAKOZU SOL VE SAĞ SÜSPANSİYON TAKOZU	Yön : Sol Ve Sağ Ağırlık : 0.035 kg / 0.077 lb Not : SÜSPANSİYON TAKOZU	1J0412303
	<b>VW13002</b> RIW DİREKSİYON KÖRÜĞÜ	Ağırlık : 0.1 kg / 0.220 lb	1J0422831, 1J0422831B 8N0422831

\* Bu sayfada ve katalogdaki tüm araçların adları, markaları, modelleri, sembolleri, logoları, orjinal numaraları (oe) ve diğer üçüncü parti numaraları sadece referans amaçlı kullanılmaktadır.

**A3 8L1 1996 - 2003**











Resim	Ürün Kodu ve Açıklaması	Detay	OEM
	<b>VW13002K</b> DİREKSİYON KÖRÜĞÜ SOL VE SAĞ 2 PİECES	Ağırlık : 0.2 kg / 0.441 lb	1J0422831, 1J0422831B 8N0422831
	<b>F114014</b> AKS KÖRÜĞÜ +KELEPÇE+YAĞ. DIŞ	Ağırlık : 0.211 kg / 0.465 lb	46307841
	<b>VW14003</b> AKS KÖRÜĞÜ +KELEPÇE+YAĞ. DIŞ	Ağırlık : 0.25 kg / 0.551 lb	1K0 498 203, 1K0498203
	<b>VW15002</b> AMORTİSÖR KÖRÜĞÜ ARKA	Şasi (Ön / Arka) : ARKA	900064

**A3 8P1 2003 - 2012**











Resim	Ürün Kodu ve Açıklaması	Detay	OEM
	<b>VW1014</b> ROTİL ÖN ALT SAĞ Ø15,6 RB2536	Ağırlık : 0,565 kg / 1.246 lb Konik Ölçüsü : Ø15,6 Bağlantı Delik Çapı : Ø10,5 Aşık Diş Çapı : M12X1,5	1K0407366B, 1K0407366C 1K0407366E, 5Q0407366A
	<b>VW1015</b> ROTİL ÖN ALT SOL Ø15,6 RB2537	Ağırlık : 0,565 kg / 1.246 lb Konik Ölçüsü : Ø15,6 Bağlantı Delik Çapı : Ø10,5 Aşık Diş Çapı : M12X1,5	1K0407365B, 1K0407365C 1K0407365E, 5Q0407365A
	<b>VW3009</b> ROTMİLİ SAĞ-SOL 310 RB2838	Ağırlık : 0,665 kg / 1.466 lb Uzunluk : 311 mm / 12.24 inch Gövde Diş Çapı : M16X1,5 Aşık Diş Çapı : M16X1,5	1K0423810A
	<b>VW20083009</b> ROT TAKIMI ÖN AKS SAĞ RB288137	Ağırlık : 1,078 kg / 2.377 lb Rotbaşı : VW2008 Rotmili : VW3009	
	<b>VW20093009</b> ROT TAKIMI ÖN SOL RB288138	Ağırlık : 1,077 kg / 2.374 lb Rotbaşı : VW2009 Rotmili : VW3009	
	<b>SK4005</b> Z ROT ÖM SAĞ-SOL L=335MM	Ağırlık : 0,322 kg / 0.710 lb Malzeme Türü : Metal Uzunluk : 335 mm / 13.19 inch Aşık Diş Çapı : M12X1,5	5Q0411315B

\* Bu sayfada ve katalogdaki tüm araçların adları, markaları, modelleri, sembolleri, logoları, orjinal numaraları (oe) ve diğer üçüncü parti numaraları sadece referans amaçlı kullanılmaktadır.

**A3**
**8P1**
**2003 - 2012**

Resim	Ürün Kodu ve Açıklaması	Detay	OEM
	<b>VW4014</b> Z ROT ÖN SAĞ-SOL METAL 335 RB2935	Ağırlık : 0,46 kg / 1.014 lb Malzeme Türü : Metal Uzunluk : 335 mm / 13.19 inch Aşık Diş Çapı : M12X1,5	1K0411315B, 1K0411315D 1K0411315J, 1K0411315K 1K0411315R, 5Q0411315A 5Q0411315B
	<b>VW4015</b> Z ROT SOL VE SAĞ METAL RB2937	Ağırlık : 0,373 kg / 0.822 lb Malzeme Türü : Metal Uzunluk : 95,5 mm / 3.76 inch Aşık Diş Çapı : M10X1,5	1K0505465C, 1K0505465D 1K0505465H, 1K0505465J 1K0505465K
	<b>VW4015K</b> Z ROT SOL VE SAĞ METAL	Ağırlık : 0,373 kg / 0.822 lb Malzeme Türü : Metal Uzunluk : 95,5 mm / 3.76 inch Aşık Diş Çapı : M10X1,5	1K0505465C, 1K0505465D 1K0505465H, 1K0505465J 1K0505465K
	<b>AU6010</b> SALINCAK ÜST SOL VE SAĞ RA5155	Ağırlık : 1,298 kg / 2.862 lb Malzeme Türü : Sac Metal	1K0505323H, 1K0505323N
	<b>AU9006</b> SALINCAK ÖN TARAF SAĞ	Ağırlık : 1,79 kg / 3.946 lb Malzeme Türü : Sac Metal	1T0505224F
	<b>AU9007</b> SALINCAK ÖN TARAF SOL	Ağırlık : 1,79 kg / 3.946 lb Malzeme Türü : Sac Metal	1T0505223F
	<b>AU9037</b> SALINCAK ARKA ALT SAĞ SAC LEVHA	Ağırlık : 1,735 kg / 3.825 lb Malzeme Türü : Sac Metal	3C0505224E
	<b>AU9038</b> SALINCAK VE DENG KOLU ARKA ALT SOL SAC LEVHA	Ağırlık : 1,735 kg / 3.825 lb Malzeme Türü : Sac Metal	3C0505223E
	<b>SE9001</b> SALINCAK ALT SAĞ RA5150	Ağırlık : 1 kg / 2.205 lb Malzeme Türü : Sac Metal	1K0501530C
	<b>SE9002</b> SALINCAK ALT SOL RA5151	Ağırlık : 1 kg / 2.205 lb Malzeme Türü : Sac Metal	1K0501529F
	<b>SK9001</b> SALINCAK ARKA ALT	Ağırlık : 0,701 kg / 1.545 lb Malzeme Türü : Sac Metal	1K0501529J











\* Bu sayfada ve katalogdaki tüm araçların adları, markaları, modelleri, sembolleri, logoları, orijinal numaraları (oe) ve diğer üçüncü parti numaraları sadece referans amaçlı kullanılmaktadır.

A3	8P1	2003 - 2012	
Resim	Ürün Kodu ve Açıklaması	Detay	OEM
	<b>VW6016</b> SALINCAK ÖN SAĞ RD10227	Ağırlık : 4,543 kg / 10.016 lb Malzeme Türü : Sac Metal	1K0407152P, 1K0407152Q* 1K0407152Q
	<b>VW6016J</b> SALINCAK ÖN ALT SAĞ S737	Ağırlık : 4,015 kg / 8.852 lb Malzeme Türü : Sac Metal	1K0407151P, 1K0407151Q 1K0407152P, 1K0407152Q
	<b>VW6017</b> SALINCAK ÖN SOL RD10226	Ağırlık : 4,543 kg / 10.016 lb Malzeme Türü : Sac Metal	1K0407151M*, 1K0407151P 1K0407151Q*, 1K0407151Q
	<b>VW6017J</b> SALINCAK ÖN ALT SOL S738	Ağırlık : 4,015 kg / 8.852 lb Malzeme Türü : Sac Metal	1K0407151P, 1K0407151Q 1K0407152P, 1K0407152Q
	<b>VW6018</b> SALINCAK ÖN SAĞ RB30219	Ağırlık : 4,85 kg / 10.692 lb Malzeme Türü : Döküm Çelik	1K0407152AC*, 1K0407152M* 1K0407152P, 1K0407152Q 1K0407152R*
	<b>VW6018J</b> SALINCAK ÖN SAĞ RB30211	Ağırlık : 4,232 kg / 9.330 lb Malzeme Türü : Döküm Çelik	1K0407152AC, 1K0407152M 1K0407152R
	<b>VW6019</b> SALINCAK ÖN SOL RB30218	Ağırlık : 4,85 kg / 10.692 lb Malzeme Türü : Döküm Çelik	1K0407151AC*, 1K0407151AC 1K0407151M*, 1K0407151M 1K0407151R*, 1K0407151R
	<b>VW6019J</b> SALINCAK ÖN SOL RB30212	Ağırlık : 4,232 kg / 9.330 lb Malzeme Türü : Döküm Çelik	1K0407151AC, 1K0407151M 1K0407151R
	<b>VW9002</b> SALINCAK ÖN TARAF SAĞ	Ağırlık : 1,79 kg / 3.946 lb Malzeme Türü : Sac Metal	1K0505224E, 1K0505224H 1K0505224K
	<b>VW9003</b> SALINCAK ÖN TARAF SOL	Ağırlık : 1,79 kg / 3.946 lb Malzeme Türü : Sac Metal	1K0505223E, 1K0505223H 1K0505223K
	<b>VW9004</b> SALINCAK ARKA	Ağırlık : 1,3 kg / 2.866 lb Malzeme Türü : Sac Metal	5Q0505323C, 5Q0505323D

\* Bu sayfada ve katalogdaki tüm araçların adları, markaları, modelleri, sembolleri, logoları, orjinal numaraları (oe) ve diğer üçüncü parti numaraları sadece referans amaçlı kullanılmaktadır.



**A3**
**8P1**
**2003 - 2012**

Resim	Ürün Kodu ve Açıklaması	Detay	OEM
	<b>AU11014</b> SALINCAK VE DENGE KOLU BURCU ARKA SOL VE SAĞ	Şasi (Ön / Arka) : ARKA Yön : Sol Ve Sağ Ağırlık : 0,192 kg / 0.423 lb	1K0505543A
	<b>AU11088</b> SALINCAK VE DENGE KOLU BURCU ARKA	Şasi (Ön / Arka) : ARKA Ağırlık : 0,165 kg / 0.364 lb	1K0505541C, 1K0505541D 3C0505541
	<b>SK11009</b> SALINCAK VE DENGE KOLU BURCU ARKA SOL VE SAĞ	Şasi (Ön / Arka) : ARKA Yön : Sol Ve Sağ Ağırlık : 0,176 kg / 0.388 lb	1K0501529J*
	<b>SK11010</b> SALINCAK VE DENGE KOLU BURCU ARKA SOL VE SAĞ	Şasi (Ön / Arka) : ARKA Yön : Sol Ve Sağ Ağırlık : 0,196 kg / 0.432 lb Not : BÜYÜK	1K0501529J*
	<b>VW11037</b> SALINCAK VE DENGE KOLU BURCU SOL VE SAĞ	Yön : Sol Ve Sağ Ağırlık : 0,11 kg / 0.243 lb	1K0505279A
	<b>VW11042</b> SALINCAK VE DENGE KOLU BURCU ORTA SOL VE SAĞ	Yön : Orta Sol Ve Sağ Ağırlık : 0,182 kg / 0.401 lb	1K0407182, 5Q0407182
	<b>VW11043</b> SALINCAK VE DENGE KOLU BURCU SAĞ B22141	Yön : Sağ Diğer Taraf : VW11044 Ağırlık : 0,659 kg / 1.453 lb	1K0199232G, 1K0199232H 1K0199232J
	<b>VW11043B</b> SALINCAK VE DENGE KOLU BURCU SAĞ	Yön : Sağ Diğer Taraf : VW11044B Ağırlık : 0,659 kg / 1.453 lb Not : İÇ BURÇSUZ	1K0199232G, 1K0199232H 1K0199232J
	<b>VW11044</b> SALINCAK VE DENGE KOLU BURCU SOL B22142	Yön : Sol Diğer Taraf : VW11043 Ağırlık : 0,678 kg / 1.495 lb	1K0199231G, 1K0199231H 1K0199231J
	<b>VW11044B</b> SALINCAK VE DENGE KOLU BURCU SOL	Yön : Sol Diğer Taraf : VW11043B Ağırlık : 0,678 kg / 1.495 lb Not : İÇ BURÇSUZ	1K0199231G, 1K0199231H 1K0199231J
	<b>VW11047</b> SALINCAK VE DENGE KOLU BURCU İÇ SOL VE SAĞ B37117	Yön : İç Sol Ve Sağ Ağırlık : 0,121 kg / 0.267 lb	1K0199231J, 1K0199231J-P 1K0407183E











\* Bu sayfada ve katalogdaki tüm araçların adları, markaları, modelleri, sembolleri, logoları, orjinal numaraları (oe) ve diğer üçüncü parti numaraları sadece referans amaçlı kullanılmaktadır.

**A3**
**8P1**
**2003 - 2012**

Resim	Ürün Kodu ve Açıklaması	Detay	OEM
	<b>VW11051</b> SALINCAK VE DENGE KOLU BURCU SOL VE SAĞ	Yön : Sol Ve Sağ Ağırlık : 0.121 kg / 0.267 lb	6Q0407183, 6Q0407183A
	<b>VW11055</b> SALINCAK VE DENGE KOLU BURCU İÇ SOL VE SAĞ	Yön : İç Sol Ve Sağ Ağırlık : 0.121 kg / 0.267 lb	1K0407183E, 8J0407183
	<b>VW11056</b> SALINCAK VE DENGE KOLU BURCU ARKA SOL VE SAĞ	Şasi (Ön / Arka) : ARKA Yön : Sol Ve Sağ Ağırlık : 0.13 kg / 0.287 lb	1K0505203A, 1K0505323D 1K0505323G, 1K0505323H 1K0505323N, 5Q0505323C
	<b>VW11180</b> Z-ROT BURCU ARKA	Şasi (Ön / Arka) : ARKA Ağırlık : 0.069 kg / 0.152 lb Uzunluk : VW4015 mm / 0.00 inch Aşık Diş Çapı : VW4015K	1K0505465C*, 1K0505465D* 1K0505465H*, 1K0505465J* 1K0505465K*
	<b>VW12159</b> TAŞIYICI DESTEK BURÇLARI ARKA SOL VE SAĞ	Şasi (Ön / Arka) : ARKA Yön : Sol Ve Sağ Ağırlık : 0,130 kg / 0.287 lb	1K0505553, 1K0505553A
	<b>AU12024</b> TORSİYON BURCU ARKA SOL VE SAĞ	Şasi (Ön / Arka) : ARKA Yön : Sol Ve Sağ Ağırlık : 0.557 kg / 1.228 lb	1K0505145F, 1K0505145H 1K0505145K
	<b>SK12003</b> VİRAJ DEMİR LASTİĞİ SOL VE SAĞ RUBBER	Şasi (Ön / Arka) : ÖN Yön : Sol Ve Sağ Ağırlık : 0,075 kg / 0.165 lb Malzeme Türü : Rubber	1K0411303, 1K0411303AL* 1K0411303BK, 1K0411314 3C0411303AA*, 3C0411303T*
	<b>SK12003K</b> VİRAJ DEMİR LASTİĞİ SOL VE SAĞ RUBBER	Şasi (Ön / Arka) : ÖN Yön : Sol Ve Sağ Ağırlık : 0,150 kg / 0.331 lb Malzeme Türü : Rubber	1K0411303, 1K0411303AL* 1K0411303BK, 1K0411314 3C0411303AA*, 3C0411303T*
	<b>VW12017</b> AMORTİSÖR TAKOZU SOL VE SAĞ AMORTİSÖR TAKOZU	Yön : Sol Ve Sağ Ağırlık : 0.847 kg / 1.867 lb Not : AMORTİSÖR TAKOZU	1K0412331B, 1K0412331C
	<b>VW12109</b> AMORTİSÖR TAKOZU SOL VE SAĞ AMORTİSÖR RULMANI	Yön : Sol Ve Sağ Ağırlık : 0.26 kg / 0.573 lb Not : AMORTİSÖR RULMANI	6N0412249C, 6N0412249E
	<b>VW12109K</b> AMORTİSÖR TAKOZU SOL VE SAĞ 2 PCS	Yön : Sol Ve Sağ Ağırlık : 0.52 kg / 1.146 lb Not : 2 PCS	6N0412249C, 6N0412249E

\* Bu sayfada ve katalogdaki tüm araçların adları, markaları, modelleri, sembolleri, logoları, orjinal numaraları (oe) ve diğer üçüncü parti numaraları sadece referans amaçlı kullanılmaktadır.

**A3**
**8P1**
**2003 - 2012**

Resim	Ürün Kodu ve Açıklaması	Detay	OEM
	<b>VW12025</b> MOTOR TAKOZU ALT SOL VE SAĞ MOTOR TAKOZU ALT	Yön : Alt Sol Ve Sağ Ağırlık : 0.25 kg / 0.551 lb Not : MOTOR TAKOZU ALT	1K0199867A, 1K0199867B 1K0199867Q
	<b>VW12027</b> MOTOR TAKOZU SOL VE SAĞ MOTOR KULAĞI	Yön : Sol Ve Sağ Ağırlık : 2.02 kg / 4.453 lb Not : MOTOR KULAĞI	1K0199262, 1K0199262CN
	<b>VW12029</b> MOTOR TAKOZU SOL VE SAĞ MOTOR TAKOZU	Yön : Sol Ve Sağ Ağırlık : 0.585 kg / 1.290 lb Not : Motor takozu	1K0199855AD, 1K0199855BA 1K0199855K
	<b>VW12032</b> MOTOR TAKOZU SOL VE SAĞ MOTOR TAKOZU	Yön : Sol Ve Sağ Ağırlık : 0.64 kg / 1.411 lb Not : Motor takozu	1K0199855BB, 1K0199855L
	<b>VW12033</b> MOTOR TAKOZU SOL VE SAĞ MOTOR TAKOZU	Yön : Sol Ve Sağ Ağırlık : 1.84 kg / 4.057 lb Not : Motor takozu	1K0199555AQ, 1K0199555AR 1K0199555Q, 1K0199555R 3C0199555AA, 3C0199555R
	<b>VW12034</b> MOTOR TAKOZU SOL VE SAĞ MOTOR TAKOZU	Yön : Sol Ve Sağ Ağırlık : 1.9 kg / 4.189 lb Not : Motor takozu	1K0199555BA, 1K0199555BB 1K0199555L, 1K0199555M 1L0199555L
	<b>VW12073</b> MOTOR TAKOZU SOL VE SAĞ MOTOR TAKOZU	Yön : Sol Ve Sağ Ağırlık : 1.643 kg / 3.622 lb Not : MOTOR TAKOZU	1K0199262AC, 1K0199262AL 1K0199262L
	<b>VW12076</b> MOTOR TAKOZU SOL VE SAĞ MOTOR TAKOZU	Yön : Sol Ve Sağ Ağırlık : 1.97 kg / 4.343 lb Not : MOTOR TAKOZU	1K0199262AF, 1K0199262AT 1K0199262BB
	<b>VW12077</b> MOTOR TAKOZU SOL VE SAĞ MOTOR TAKOZU	Yön : Sol Ve Sağ Ağırlık : 1.95 kg / 4.299 lb Not : MOTOR TAKOZU	1K0199262CG, 1K0199262CP
	<b>VW12078</b> MOTOR TAKOZU SOL VE SAĞ ŞANZUMAN TAKOZU	Yön : Sol Ve Sağ Ağırlık : 1.78 kg / 3.924 lb Not : ŞANZUMAN TAKOZU	1K0199555AC
	<b>VW12082</b> MOTOR TAKOZU SOL VE SAĞ MOTOR TAKOZU	Yön : Sol Ve Sağ Ağırlık : 2.05 kg / 4.519 lb Not : MOTOR TAKOZU	1K0199262AK, 1K0199262K

\* Bu sayfada ve katalogdaki tüm araçların adları, markaları, modelleri, sembolleri, logoları, orjinal numaraları (oe) ve diğer üçüncü parti numaraları sadece referans amaçlı kullanılmaktadır.

**A3**
**8P1**
**2003 - 2012**





Resim	Ürün Kodu ve Açıklaması	Detay	OEM
	<b>VW12094</b> MOTOR TAKOZU SOL VE SAĞ MOTOR TAKOZU	Yön : Sol Ve Sağ Ağırlık : 1.872 kg / 4.127 lb Not : MOTOR TAKOZU	1K0199555N
	<b>VW12097</b> MOTOR TAKOZU SOL VE SAĞ MOTOR TAKOZU	Yön : Sol Ve Sağ Ağırlık : 0.251 kg / 0.553 lb Not : MOTOR TAKOZU	1K0199868, 1K0199868A 1K0199868C, 1K0199868P 1K0199868Q
	<b>VW12110</b> MOTOR TAKOZU SOL VE SAĞ MOTOR TAKOZU	Yön : Sol Ve Sağ Ağırlık : 1.918 kg / 4.228 lb Not : MOTOR TAKOZU	1K0199262AB, 1K0199262AM 1K0199262M
	<b>VW12124</b> MOTOR TAKOZU SOL VE SAĞ	Yön : Sol Ve Sağ Ağırlık : 1.927 kg / 4.248 lb	1K0199262A, 1K0199262AA 1K0199262AS
	<b>VW12106</b> ŞANZIMAN TAKOZU SOL ŞANZUMAN TAKOZU SOL	Yön : Sol Ağırlık : 1.95 kg / 4.299 lb Not : ŞANZUMAN TAKOZU SOL	1K0199555AT, 1K0199555T
	<b>AU12037</b> SÜSPANSİYON TAKOZU ARKA	Şasi (Ön / Arka) : ARKA Ağırlık : 0,095 kg / 0.209 lb	1K0511353J
	<b>AU12041</b> SÜSPANSİYON TAKOZU ARKA	Şasi (Ön / Arka) : ARKA Ağırlık : 0,075 kg / 0.165 lb	8J0511353F
	<b>VW12051</b> SÜSPANSİYON TAKOZU SOL VE SAĞ LASTİK DAYANAK SÜSPANSİYON	Yön : Sol Ve Sağ Ağırlık : 0.045 kg / 0.099 lb Not : LASTİK DAYANAK SÜSPANSİYON	1K0412303B
	<b>VW12067</b> SÜSPANSİYON TAKOZU SOL VE SAĞ SÜSPANSİYON TAKOZU	Yön : Sol Ve Sağ Ağırlık : 0.065 kg / 0.143 lb Not : SÜSPANSİYON TAKOZU	1K0412303P
	<b>VW12086</b> RADYATÖR TAKOZU SOL VE SAĞ RADYATÖR ÜST LASTİĞİ	Yön : Sol Ve Sağ Ağırlık : 0.024 kg / 0.053 lb Not : RADYATÖR ÜST LASTİĞİ	1K0121367F
	<b>VW13006</b> DİREKSİYON KÖRÜĞÜ	Ağırlık : 0.145 kg / 0.320 lb	1K0423831A, 5C0423831

\* Bu sayfada ve katalogdaki tüm araçların adları, markaları, modelleri, sembolleri, logoları, orjinal numaraları (oe) ve diğer üçüncü parti numaraları sadece referans amaçlı kullanılmaktadır.











**A3 8P1 2003 - 2012**

Resim	Ürün Kodu ve Açıklaması	Detay	OEM
	<b>VW13006K</b> DİREKSİYON KÖRÜĞÜ SOL VE SAĞ 2 PİECES	Ağırlık : 0.29 kg / 0.639 lb	1K0423831A, 5C0423831
	<b>VW14003</b> AKS KÖRÜĞÜ +KELEPÇE+YAĞ. DIŞ	Ağırlık : 0.25 kg / 0.551 lb	1K0 498 203, 1K0498203
	<b>VW14011</b> AKS KÖRÜĞÜ +KELEPÇE+YAĞ. İÇ	Ağırlık : 0.236 kg / 0.520 lb	1K0498201D
	<b>AU15001</b> AMORTİSÖR KÖRÜĞÜ ÖN	Şasi (Ön / Arka) : ÖN Ağırlık : 0,110 kg / 0.243 lb	6N0413175A
	<b>VW15002</b> AMORTİSÖR KÖRÜĞÜ ARKA	Şasi (Ön / Arka) : ARKA	900064

**A3 8V1 2012 - 2020**







Resim	Ürün Kodu ve Açıklaması	Detay	OEM
	<b>VW1014</b> ROTİL ÖN ALT SAĞ Ø15,6 RB2536	Ağırlık : 0,565 kg / 1.246 lb Konik Ölçüsü : Ø15,6 Bağlantı Delik Çapı : Ø10,5 Aşık Diş Çapı : M12X1,5	1K0407366B, 1K0407366C 1K0407366E, 5Q0407366A
	<b>VW1015</b> ROTİL ÖN ALT SOL Ø15,6 RB2537	Ağırlık : 0,565 kg / 1.246 lb Konik Ölçüsü : Ø15,6 Bağlantı Delik Çapı : Ø10,5 Aşık Diş Çapı : M12X1,5	1K0407365B, 1K0407365C 1K0407365E, 5Q0407365A
	<b>VW2008</b> ROTBAŞI ÖN SAĞ RD0342	Ağırlık : 0,412 kg / 0.908 lb Uzunluk : 95 mm / 3.74 inch Gövde Diş Çapı : M16X1,5 Aşık Diş Çapı : M12X1,5 Aşık Konik Çapı : Ø12,7	1K0423812A, 1K0423812C 1K0423812E, 1K0423812G 1K0423812J, 1K0423812K 1KD423812A
	<b>VW2009</b> ROTBAŞI ÖN SOL RD0343	Ağırlık : 0,412 kg / 0.908 lb Uzunluk : 95 mm / 3.74 inch Gövde Diş Çapı : M16X1,5 Aşık Diş Çapı : M12X1,5 Aşık Konik Çapı : Ø13,5	1K0423811A, 1K0423811C 1K0423811E, 1K0423811G 1K0423811J, 1K0423811K 1KD423811A
	<b>VW3009</b> ROTMİLİ SAĞ-SOL 310 RB2838	Ağırlık : 0,665 kg / 1.466 lb Uzunluk : 311 mm / 12.24 inch Gövde Diş Çapı : M16X1,5 Aşık Diş Çapı : M16X1,5	1K0423810A

\* Bu sayfada ve katalogdaki tüm araçların adları, markaları, modelleri, sembolleri, logoları, orjinal numaraları (oe) ve diğer üçüncü parti numaraları sadece referans amaçlı kullanılmaktadır.

A3	8V1	2012 - 2020	
Resim	Ürün Kodu ve Açıklaması	Detay	OEM
	<b>VW20083009</b> ROT TAKIMI ÖN AKS SAĞ RB288137	Ağırlık : 1,078 kg / 2.377 lb Rotbaşı : VW2008 Rotmili : VW3009	
	<b>VW20093009</b> ROT TAKIMI ÖN SOL RB288138	Ağırlık : 1,077 kg / 2.374 lb Rotbaşı : VW2009 Rotmili : VW3009	
	<b>SK4005</b> Z ROT ÖM SAĞ-SOL L=335MM	Ağırlık : 0,322 kg / 0.710 lb Malzeme Türü : Metal Uzunluk : 335 mm / 13.19 inch Aşık Diş Çapı : M12X1,5	5Q0411315B
	<b>VW4031</b> Z ROT ARKA PLASTİK	Ağırlık : 0,15 kg / 0.331 lb Malzeme Türü : Plastik Uzunluk : 70 mm / 2.76 inch Aşık Diş Çapı : M10X1,5	5Q0505465A, 5Q0505465C
	<b>AU9009</b> SALINCAK ALT SOL VE SAĞ	Ağırlık : 2,910 kg / 6.415 lb Malzeme Türü : Sac Metal	5Q0505311C, 5Q0505311D
	<b>AU9012</b> SALINCAK ARKA ALT SAĞ	Ağırlık : 1,640 kg / 3.616 lb Malzeme Türü : Sac Metal	5Q0505224D
	<b>AU9013</b> SALINCAK ARKA ALT SOL	Ağırlık : 1,640 kg / 3.616 lb Malzeme Türü : Sac Metal	5Q0505223D
	<b>VW6039</b> SALINCAK ÖN ALT SAĞ METAL	Ağırlık : 3,763 kg / 8.296 lb Malzeme Türü : Sac Metal	5Q0407152J*, 5Q0407152J 5Q0407152L
	<b>VW6039J</b> SALINCAK ÖN ALT SAĞ METAL	Ağırlık : 3,206 kg / 7.068 lb Malzeme Türü : Sac Metal	5Q0407152J*, 5Q0407152J 5Q0407154E
	<b>VW6040</b> SALINCAK ÖN ALT SOL METAL	Ağırlık : 3,763 kg / 8.296 lb Malzeme Türü : Sac Metal	5Q0407151J*, 5Q0407151J 5Q0407151L
	<b>VW6040J</b> SALINCAK ÖN ALT SOL METAL	Ağırlık : 3,206 kg / 7.068 lb Malzeme Türü : Sac Metal	5Q0407151J*, 5Q0407151J 5Q0407153E

\* Bu sayfada ve katalogdaki tüm araçların adları, markaları, modelleri, sembolleri, logoları, orjinal numaraları (oe) ve diğer üçüncü parti numaraları sadece referans amaçlı kullanılmaktadır.

**A3 8V1 2012 - 2020**

Resim	Ürün Kodu ve Açıklaması	Detay	OEM
	<b>VW9004</b> SALINCAK ARKA	Ağırlık : 1,3 kg / 2.866 lb Malzeme Türü : Sac Metal	5Q0505323C, 5Q0505323D
	<b>VW9005</b> SALINCAK ARKA ALT ÖNDEN	Ağırlık : 0,566 kg / 1.248 lb Malzeme Türü : Sac Metal	5Q0501529C, 5Q0501529D 5Q0501529E, 5Q0501529F
	<b>AU11068</b> SALINCAK VE DENGİ KOLU BURCU ARKA ALT SOL VE SAĞ METAL	Şasi (Ön / Arka) : ARKA Yön : Alt Sol Ve Sağ Ağırlık : 0,201 kg / 0.443 lb Malzeme Türü : Metal	PART OF 5Q0505223D, PART OF 5Q0505224D
	<b>AU11070</b> SALINCAK VE DENGİ KOLU BURCU ARKA ALT	Şasi (Ön / Arka) : ARKA Yön : Alt Ağırlık : 0,100 kg / 0.220 lb	5Q0505171, 5Q0505311C 5Q0505311CSK, 5Q0505311D 5Q0505311DSK
	<b>VW11037</b> SALINCAK VE DENGİ KOLU BURCU SOL VE SAĞ	Yön : Sol Ve Sağ Ağırlık : 0.11 kg / 0.243 lb	1K0505279A
	<b>VW11042</b> SALINCAK VE DENGİ KOLU BURCU ORTA SOL VE SAĞ	Yön : Orta Sol Ve Sağ Ağırlık : 0,182 kg / 0.401 lb	1K0407182, 5Q0407182
	<b>VW11063</b> SALINCAK VE DENGİ KOLU BURCU SOL VE SAĞ	Yön : Sol Ve Sağ Ağırlık : 0.34 kg / 0.750 lb	5Q0407183D, 5Q0407183E
	<b>VW11075</b> SALINCAK VE DENGİ KOLU BURCU ARKA SOL VE SAĞ	Şasi (Ön / Arka) : ARKA Yön : Sol Ve Sağ Ağırlık : 0,870 kg / 1.918 lb Not : FORWARD and INNER	Part of 5Q0501529C, Part of 5Q0501529D Part of 5Q0501529E, Part of 5Q0501529F
	<b>VW11076</b> SALINCAK VE DENGİ KOLU BURCU ARKA SOL VE SAĞ	Şasi (Ön / Arka) : ARKA Yön : Sol Ve Sağ Ağırlık : 0,870 kg / 1.918 lb Not : FORWARD and OUTER	Part of 5Q0501529C, Part of 5Q0501529D Part of 5Q0501529E, Part of 5Q0501529F
	<b>VW12159</b> TAŞIYICI DESTEK BURÇLARI ARKA SOL VE SAĞ	Şasi (Ön / Arka) : ARKA Yön : Sol Ve Sağ Ağırlık : 0,130 kg / 0.287 lb	1K0505553, 1K0505553A
	<b>AU12027</b> AMORTİSÖR TAKOZU ARKA ÜST SAĞ	Şasi (Ön / Arka) : ARKA Yön : Üst Sağ Ağırlık : 0,415 kg / 0.915 lb	5Q0513353H

\* Bu sayfada ve katalogdaki tüm araçların adları, markaları, modelleri, sembolleri, logoları, orijinal numaraları (oe) ve diğer üçüncü parti numaraları sadece referans amaçlı kullanılmaktadır.

**A3**
**8V1**
**2012 - 2020**

Resim	Ürün Kodu ve Açıklaması	Detay	OEM
	<b>AU12019</b> MOTOR TAKOZU SOL VE SAĞ MOTOR TAKOZU	Yön : Sol Ve Sağ Ağırlık : 0.204 kg / 0.450 lb Malzeme Türü : Motor Takozu	5Q0198037, 5QD199867
	<b>AU12019K</b> MOTOR TAKOZU SOL VE SAĞ MOTOR TAKOZU TAKIM	Yön : Sol Ve Sağ Ağırlık : 0.408 kg / 0.899 lb Malzeme Türü : Motor Takozu Takim	5Q0198037
	<b>AU12020</b> MOTOR TAKOZU SOL VE SAĞ MOTOR TAKOZU	Yön : Sol Ve Sağ Ağırlık : 0.21 kg / 0.463 lb Malzeme Türü : Motor Takozu	5Q0198037, 5Q0199868 5QD199868
	<b>AU12022</b> MOTOR TAKOZU SOL VE SAĞ MOTOR TAKOZU	Yön : Sol Ve Sağ Ağırlık : 1.58 kg / 3.483 lb Malzeme Türü : Motor Takozu	5Q0199262, 5Q0199262BH 5Q0199262DE
	<b>AU12023</b> MOTOR TAKOZU SOL VE SAĞ MOTOR TAKOZU 7 İLERİ	Yön : Sol Ve Sağ Ağırlık : 1.58 kg / 3.483 lb Malzeme Türü : Motor Takozu Not : 7 İLERİ	5Q0199262BE, 5Q0199262BF
	<b>AU12026</b> MOTOR TAKOZU ÖN SOL VE SAĞ	Şasi (Ön / Arka) : ÖN Yön : Sol Ve Sağ Ağırlık : 0,850 kg / 1.874 lb	5Q0199855AD, 5Q0199855J 5Q0199855P, 5Q0199855Q
	<b>SK12005</b> MOTOR TAKOZU ÖN SAĞ	Şasi (Ön / Arka) : ÖN Yön : Sağ Ağırlık : 1,575 kg / 3.472 lb	5Q0199262CK
	<b>VW12157</b> MOTOR TAKOZU ÖN SOL VE SAĞ	Şasi (Ön / Arka) : ÖN Yön : Sol Ve Sağ Ağırlık : 2.2 kg / 4.850 lb	5Q0199555AF, 5Q0199555T 5Q0199555AP
	<b>VW12051</b> SÜSPANSİYON TAKOZU SOL VE SAĞ LASTİK DAYANAK SÜSPANSİYON	Yön : Sol Ve Sağ Ağırlık : 0.045 kg / 0.099 lb Not : LASTİK DAYANAK SÜSPANSİYON	1K0412303B
	<b>VW12086</b> RADYATÖR TAKOZU SOL VE SAĞ RADYATÖR ÜST LASTİĞİ	Yön : Sol Ve Sağ Ağırlık : 0.024 kg / 0.053 lb Not : RADYATÖR ÜST LASTİĞİ	1K0121367F
	<b>VW13006</b> DİREKSİYON KÖRÜĞÜ	Ağırlık : 0.145 kg / 0.320 lb	1K0423831A, 5C0423831



\* Bu sayfada ve katalogdaki tüm araçların adları, markaları, modelleri, sembolleri, logoları, orjinal numaraları (oe) ve diğer üçüncü parti numaraları sadece referans amaçlı kullanılmaktadır.



**A3 8V1 2012 - 2020**





Resim	Ürün Kodu ve Açıklaması	Detay	OEM
	<b>VW13006K</b> DİREKSİYON KÖRÜĞÜ SOL VE SAĞ 2 PİECES	Ağırlık : 0.29 kg / 0.639 lb	1K0423831A, 5C0423831

**A3 8Y 2020 -**

Resim	Ürün Kodu ve Açıklaması	Detay	OEM
	<b>VW2031</b> ROTBAŞI SAĞ	Ağırlık : 0,515 kg / 1.135 lb	5WA423812B, 5WA423812C 5WA423812D
	<b>VW2032</b> ROTBAŞI SOL	Ağırlık : 0,515 kg / 1.135 lb	5WA423811B, 5WA423811C 5WA423811D
	<b>VW3030</b> ROTMİLİ ÖN	Ağırlık : 0,655 kg / 1.444 lb Uzunluk : 310 mm / 12.20 inch Gövde Diş Çapı : M16X1,5 Aşık Diş Çapı : M16X1,5	5WA423810C
	<b>VW4014</b> Z ROT ÖN SAĞ-SOL METAL 335 RB2935	Ağırlık : 0,46 kg / 1.014 lb Malzeme Türü : Metal Uzunluk : 335 mm / 13.19 inch Aşık Diş Çapı : M12X1,5	1K0411315B, 1K0411315D 1K0411315J, 1K0411315K 1K0411315R, 5Q0411315A 5Q0411315B
	<b>VW4035</b> Z ROT ARKA PLASTİK	Ağırlık : 0,165 kg / 0.364 lb Malzeme Türü : Plastik Uzunluk : 111 mm / 4.37 inch	5WA505465A
	<b>AU9012</b> SALINCAK ARKA ALT SAĞ	Ağırlık : 1,640 kg / 3.616 lb Malzeme Türü : Sac Metal	5Q0505224D
	<b>AU9013</b> SALINCAK ARKA ALT SOL	Ağırlık : 1,640 kg / 3.616 lb Malzeme Türü : Sac Metal	5Q0505223D
	<b>VW9012</b> SALINCAK VE DENGE KOLU ARKA ALT ÖNDEN SAC LEVHA	Ağırlık : 0,675 kg / 1.488 lb Malzeme Türü : Sac Metal	5Q0501529G
	<b>AU11068</b> SALINCAK VE DENGE KOLU BURCU ARKA ALT SOL VE SAĞ METAL	Şasi (Ön / Arka) : ARKA Yön : Alt Sol Ve Sağ Ağırlık : 0,201 kg / 0.443 lb Malzeme Türü : Metal	PART OF 5Q0505223D, PART OF 5Q0505224D

\* Bu sayfada ve katalogdaki tüm araçların adları, markaları, modelleri, sembolleri, logoları, orjinal numaraları (oe) ve diğer üçüncü parti numaraları sadece referans amaçlı kullanılmaktadır.

**A3 8Y 2020 -**

Resim	Ürün Kodu ve Açıklaması	Detay	OEM
	<b>VW11076</b> SALINCAK VE DENG KOLU BURCU ARKA SOL VE SAĞ	Şasi (Ön / Arka) : ARKA Yön : Sol Ve Sağ Ağırlık : 0,870 kg / 1.918 lb Not : FORWARD and OUTER	Part of 5Q0501529C, Part of 5Q0501529D Part of 5Q0501529E, Part of 5Q0501529F
	<b>AU11080</b> BEŞİK (TRAVERS) BURCU ÖN ALT	Şasi (Ön / Arka) : ÖN Yön : Alt Ağırlık : 0,135 kg / 0.298 lb	5Q0505553
	<b>SK12005</b> MOTOR TAKOZU ÖN SAĞ	Şasi (Ön / Arka) : ÖN Yön : Sağ Ağırlık : 1,575 kg / 3.472 lb	5Q0199262CK
	<b>AU12042</b> SÜSPANSİYON TAKOZU ARKA	Şasi (Ön / Arka) : ARKA Ağırlık : 0,095 kg / 0.209 lb	5N0412303C

**A3 GBA 8P1 2003 - 2012**

Resim	Ürün Kodu ve Açıklaması	Detay	OEM
	<b>VW2008</b> ROTBAŞI ÖN SAĞ RD0342	Ağırlık : 0,412 kg / 0.908 lb Uzunluk : 95 mm / 3.74 inch Gövde Diş Çapı : M16X1,5 Aşık Diş Çapı : M12X1,5 Aşık Konik Çapı : Ø12,7	1K0423812A, 1K0423812C 1K0423812E, 1K0423812G 1K0423812J, 1K0423812K 1KD423812A
	<b>VW2009</b> ROTBAŞI ÖN SOL RD0343	Ağırlık : 0,412 kg / 0.908 lb Uzunluk : 95 mm / 3.74 inch Gövde Diş Çapı : M16X1,5 Aşık Diş Çapı : M12X1,5 Aşık Konik Çapı : Ø13,5	1K0423811A, 1K0423811C 1K0423811E, 1K0423811G 1K0423811J, 1K0423811K 1KD423811A

**A4 8D2, 8E5, B5 1995 - 2001**

Resim	Ürün Kodu ve Açıklaması	Detay	OEM
	<b>AU2214</b> ROTBAŞI ÖN SAĞ - SOL RB2214	Ağırlık : 0,594 kg / 1.310 lb Uzunluk : 156 mm / 6.14 inch Gövde Diş Çapı : M14X1,5 Aşık Diş Çapı : M8X1,25 Aşık Konik Çapı : Ø17.5	4B0419811B, 4B0419811C 4B0419811E, 4B0419811F 4D0419811A, 4D0419811B 4D0419811G, 4D0419811H 4F0419811E, 4F0498811
	<b>AU3002</b> ROTMİLİ SAĞ-SOL 144 MM RB2814	Ağırlık : 0,445 kg / 0.981 lb Uzunluk : 130 mm / 5.12 inch Gövde Diş Çapı : M16X1,5 Aşık Diş Çapı : M14X1,5	4B0422821, 4D0422821 4D0422821A

## AU8001 / Süspansiyon Kit Ön

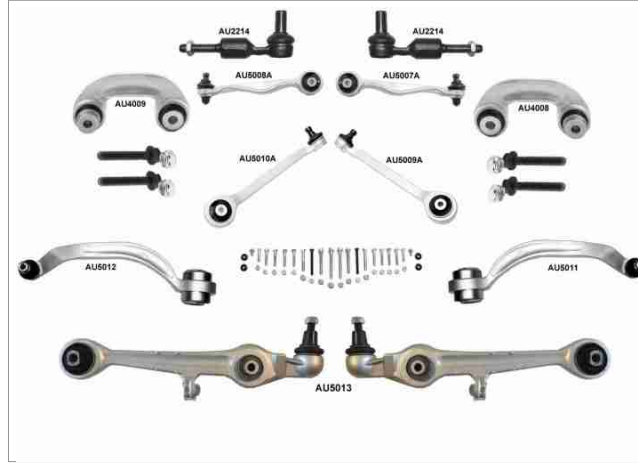

**A4**
**8D2, 8E5, B5**
**1995 - 2001**

**OEM**

8D0498998, 8D0498998-S1

### Kit Parçaları

Resim	Ürün Kodu / Adı	OEM	OEM	Ürün Kodu / Adı	Resim
	<b>AU2214</b> Rotbaşı Ön Sağ - Sol Rb2214	4B0419811B, 4B0419811C 4B0419811E, 4B0419811F 4D0419811A, 4D0419811B 4D0419811G, 4D0419811H 4F0419811E, 4F0498811	4B0419811B, 4B0419811C 4B0419811E, 4B0419811F 4D0419811A, 4D0419811B 4D0419811G, 4D0419811H 4F0419811E, 4F0498811	<b>AU2214</b> Rotbaşı Ön Sağ - Sol Rb2214	
	<b>AU4008</b> Z Rot Ön Sağ Alüminyum 90 Rb2921	8D0407318D, 8D0411318D	8D0407317D, 8D0411317D	<b>AU4009</b> Z Rot Ön Sol Alüminyum 90 Rb2920	
	<b>AU5007A</b> Salıncak Ön Üst Sağ Rb2629	4D0407510B, 4D0407510D 4D0407510F, 4D0407510G 4D0407510H, 4D0407510J 4D0407510K, 8D0407510A 8D0407510C, 8D0407510E	4D0407509F, 4D0407509G 4D0407509J, 4D0407509K 8D0407509C, 8D0407509E 8E0407509A	<b>AU5008A</b> Salıncak Ön Üst Sol Rb2628	
	<b>AU5009A</b> Salıncak Ön Üst Sağ Rb2635	8D0407506A, 8D0407506B 8E0407506A, 8E0407506P	8D0407505A, 8E0407505A 8E0407505P	<b>AU5010A</b> Salıncak Ön Üst Sol Rb2634	
	<b>AU5011</b> Salıncak Ön Alt Sağ Rb2637	4D0407694AC, 4D0407694AD 4D0407694E, 4D0407694H 4D0407694K, 4D0407694M 4D0407694N, 8E0407694 8E0407694AG, 8E0407694E	4D0407693AC, 4D0407693AD 4D0407693E, 4D0407693H 4D0407693K, 4D0407693M 4D0407693N, 8E0407693 8E0407693AG, 8E0407693E	<b>AU5012</b> Salıncak Ön Alt Sol Rb2636	
	<b>AU5013</b> Salıncak Ön Alt Ön Taraf Sol Ve Sağ Alüminyum Rb2616	4B3407151C, 4B3407151E 4D0407151G, 4D0407151H 4D0407151J	4B3407151C, 4B3407151E 4D0407151G, 4D0407151H 4D0407151J	<b>AU5013</b> Salıncak Ön Alt Ön Taraf Sol Ve Sağ Alüminyum Rb2616	

**A4 8D2, 8E5, B5 1995 - 2001**

Resim	Ürün Kodu ve Açıklaması	Detay	OEM
	<b>AU22143002</b> ROT TAKIMI ÖN AKS RB288115	Ağırlık : 1,043 kg / 2.299 lb Rotbaşı : AU2214 Rotmili : AU3002	1J0422812A, 4B0419801B 4B0419801E, 4B0419801M 4D0419801B, 4D0419801C 4D0419801D, 4D0419801L
	<b>AU4003</b> Z ROT SAĞ RB2913	Ağırlık : 0,406 kg / 0.895 lb Uzunluk : 226,5 mm / 8.92 inch Aşık Diş Çapı : M10X1,5	8A0505466C, 8D0505466
	<b>AU4004</b> Z ROT SOL RB2914	Ağırlık : 0,404 kg / 0.891 lb Uzunluk : 226,5 mm / 8.92 inch Aşık Diş Çapı : M10X1,5	8A0505465C, 8D0505465
	<b>AU4007</b> Z ROT ÖN SAĞ-SOL ALİMİNYUM 90 RB2942	Ağırlık : 0,378 kg / 0.833 lb Malzeme Türü : Alüminyum Uzunluk : 86 mm / 3.39 inch Aşık Diş Çapı : M10X1,5	4D0411317G, 4D0411317J 4D0411317K
	<b>AU4008</b> Z ROT ÖN SAĞ ALİMİNYUM 90 RB2921	Ağırlık : 0,347 kg / 0.765 lb Malzeme Türü : Alüminyum Uzunluk : 90 mm / 3.54 inch	8D0407318D, 8D0411318D
	<b>AU4009</b> Z ROT ÖN SOL ALİMİNYUM 90 RB2920	Ağırlık : 0,347 kg / 0.765 lb Malzeme Türü : Alüminyum Uzunluk : 90 mm / 3.54 inch	8D0407317D, 8D0411317D
	<b>AU4010</b> Z ROT ÖN SAĞ-SOL ALİMİNYUM 90 RB2912	Ağırlık : 0,325 kg / 0.717 lb Malzeme Türü : Alüminyum Uzunluk : 90 mm / 3.54 inch	4D0411317J, 4D0411317K
	<b>AU5007</b> SALINCAK ÖN ÜST SAĞ	Malzeme Türü : Alüminyum	4D0407510B, 4D0407510D
	<b>AU5008</b> SALINCAK ÖN ÜST SOL	Malzeme Türü : Alüminyum	4D0407509B, 4D0407509D
	<b>AU5009</b> SALINCAK ÖN ÜST SAĞ RB2630	Malzeme Türü : Alüminyum	8D0407506B, 8D0407506F 8D0407506H, 8D0407506K
	<b>AU5010</b> SALINCAK ÖN ÜST SOL RB2631	Malzeme Türü : Alüminyum	8D0407505B, 8D0407505F 8D0407505H, 8D0407505K











\* Bu sayfada ve katalogdaki tüm araçların adları, markaları, modelleri, sembolleri, logoları, orjinal numaraları (oe) ve diğer üçüncü parti numaraları sadece referans amaçlı kullanılmaktadır.

**A4**
**8D2, 8E5, B5**
**1995 - 2001**

Resim	Ürün Kodu ve Açıklaması	Detay	OEM
	<b>AU5011</b> SALINCAK ÖN ALT SAĞ RB2637	Ağırlık : 1,750 kg / 3.858 lb Malzeme Türü : Alüminyum	4D0407694AC, 4D0407694AD 4D0407694E, 4D0407694H 4D0407694K, 4D0407694M 4D0407694N, 8E0407694 8E0407694AG, 8E0407694E
	<b>AU5012</b> SALINCAK ÖN ALT SOL RB2636	Ağırlık : 1,800 kg / 3.968 lb Malzeme Türü : Alüminyum	4D0407693AC, 4D0407693AD 4D0407693E, 4D0407693H 4D0407693K, 4D0407693M 4D0407693N, 8E0407693 8E0407693AG, 8E0407693E
	<b>AU5013</b> SALINCAK ÖN ALT ÖN TARAF SOL VE SAĞ ALÜMİNYUM RB2616	Ağırlık : 1,520 kg / 3.351 lb Malzeme Türü : Alüminyum	4B3407151C, 4B3407151E 4D0407151G, 4D0407151H 4D0407151J
	<b>AU5015</b> SALINCAK ARKA RB2624	Ağırlık : 1,140 kg / 2.513 lb Malzeme Türü : Dövme Çelik	8D0501530
	<b>AU11004</b> SALINCAK VE DENGE KOLU BURCU ÖN ORTA SOL VE SAĞ B22112	Şasi (Ön / Arka) : ÖN Yön : Orta Sol Ve Sağ Ağırlık : 0,112 kg / 0.247 lb	4D0407181F, 4D0407181H
	<b>AU11006</b> SALINCAK VE DENGE KOLU BURCU ÖN SOL VE SAĞ	Şasi (Ön / Arka) : ÖN Yön : Sol Ve Sağ Ağırlık : 0,225 kg / 0.496 lb	4D0407182E, 4D0407182G 8E0407182A, 8E0407182E
	<b>AU11007</b> SALINCAK VE DENGE KOLU BURCU ÖN ALT SOL VE SAĞ	Şasi (Ön / Arka) : ÖN Yön : Alt Sol Ve Sağ Ağırlık : 0,59 kg / 1.301 lb	4D0407183AB, 4D0407183AC 4D0407183D, 4D0407183M 4D0407183N, 4D0407183P 4D0407183S
	<b>AU11015</b> SALINCAK VE DENGE KOLU BURCU ARKA SOL VE SAĞ	Şasi (Ön / Arka) : ARKA Yön : Sol Ve Sağ Ağırlık : 0,34 kg / 0.750 lb	8D0501541A
	<b>AU11036</b> SALINCAK VE DENGE KOLU BURCU ÖN SOL VE SAĞ	Şasi (Ön / Arka) : ÖN Yön : Sol Ve Sağ Ağırlık : 0,25 kg / 0.551 lb Not : DENGE KOLU BURCU	4H0407515, 8D0407515A 8K0407515, 8R0407515
	<b>AU11061</b> SALINCAK VE DENGE KOLU BURCU ARKA SOL VE SAĞ	Şasi (Ön / Arka) : ARKA Yön : Sol Ve Sağ Ağırlık : 0,423 kg / 0.933 lb	8D0501530**, 8D0501530-P
	<b>VW11052</b> SALINCAK VE DENGE KOLU BURCU ALT SOL VE SAĞ B22130	Yön : Alt Sol Ve Sağ Ağırlık : 0,523 kg / 1.153 lb	4D0407183M, 4D0407183N 4D0407183P, 4D0407183Q 4E0407183M









\* Bu sayfada ve katalogdaki tüm araçların adları, markaları, modelleri, sembolleri, logoları, orijinal numaraları (oe) ve diğer üçüncü parti numaraları sadece referans amaçlı kullanılmaktadır.

**A4**
**8D2, 8E5, B5**
**1995 - 2001**

Resim	Ürün Kodu ve Açıklaması	Detay	OEM
	<b>AU11024</b> Z-ROT BURCU ARKA	Şasi (Ön / Arka) : ARKA Ağırlık : 0.55 kg / 1.213 lb Uzunluk : AU4003 mm / 0.00 inch Aşık Diş Çapı : AU4004	8A0505465C*, 8A0505466C* 8D0505465*, 8D0505466*
	<b>AU12029</b> ROTMİLİ BURCU VE LASTİĞİ ÖN	Şasi (Ön / Arka) : ÖN	171419804*, 171419804A* 175419804*
	<b>AU12029K</b> ROTMİLİ BURCU VE LASTİĞİ ÖN	Şasi (Ön / Arka) : ÖN	171419804*, 171419804A* 175419804*
	<b>AU12005</b> VİRAJ DEMİR LASTİĞİ SOL VE SAĞ RUBBER	Şasi (Ön / Arka) : ÖN Yön : Sol Ve Sağ Ağırlık : 0.06 kg / 0.132 lb Malzeme Türü : Rubber	4D0411327F, 4D0411327H
	<b>AU12005K</b> VİRAJ DEMİR LASTİĞİ SOL VE SAĞ RUBBER	Şasi (Ön / Arka) : ÖN Yön : Sol Ve Sağ Ağırlık : 0.12 kg / 0.265 lb Malzeme Türü : Rubber	4D0411327F, 4D0411327H
	<b>VW12020</b> VİRAJ DEMİR LASTİĞİ SOL VE SAĞ RUBBER	Şasi (Ön / Arka) : ÖN Yön : Sol Ve Sağ Ağırlık : 0.07 kg / 0.154 lb Malzeme Türü : Rubber Not : VİRAJ ORTA LASTİĞİ	8D0511327C
	<b>VW12020K</b> VİRAJ DEMİR LASTİĞİ SOL VE SAĞ RUBBER	Şasi (Ön / Arka) : ÖN Yön : Sol Ve Sağ Ağırlık : 0.14 kg / 0.309 lb Malzeme Türü : Rubber	8D0511327C*
	<b>VW12087</b> VİRAJ DEMİR LASTİĞİ SOL VE SAĞ RUBBER	Şasi (Ön / Arka) : ÖN Yön : Sol Ve Sağ Ağırlık : 0.059 kg / 0.130 lb Malzeme Türü : Rubber Not : VİRAJ LASTİĞİ	4D0411327E, 4D0411327G
	<b>VW12087K</b> VİRAJ DEMİR LASTİĞİ SOL VE SAĞ RUBBER	Şasi (Ön / Arka) : ÖN Yön : Sol Ve Sağ Ağırlık : 0.118 kg / 0.260 lb Malzeme Türü : Rubber	4D0411327E*, 4D0411327G*
	<b>VW12022</b> AMORTİSÖR TAKOZU SOL VE SAĞ AMORTİSÖR TAKOZU	Yön : Sol Ve Sağ Ağırlık : 0.44 kg / 0.970 lb Not : AMORTİSÖR TAKOZU	4D0412377F
	<b>AU12033</b> MOTOR TAKOZU ÖN	Şasi (Ön / Arka) : ÖN Ağırlık : 0,825 kg / 1.819 lb	4B0199379A, 4B0199379E





\* Bu sayfada ve katalogdaki tüm araçların adları, markaları, modelleri, sembolleri, logoları, orjinal numaraları (oe) ve diğer üçüncü parti numaraları sadece referans amaçlı kullanılmaktadır.

**A4**
**8D2, 8E5, B5**
**1995 - 2001**

Resim	Ürün Kodu ve Açıklaması	Detay	OEM
	<b>VW12031</b> MOTOR TAKOZU SOL VE SAĞ MOTOR TAKOZU	Yön : Sol Ve Sağ Ağırlık : 0.831 kg / 1.832 lb Not : Motor takozu	8D0199379K
	<b>VW12039</b> MOTOR TAKOZU SOL VE SAĞ MOTOR TAKOZU	Yön : Sol Ve Sağ Ağırlık : 0.816 kg / 1.799 lb Not : MOTOR TAKOZU	8D0199379C, 8D0199382AC 8D0199382AE, 8D0199382AP 8D0199382AR, 8D0199382C 8D0199382G, 8D0199382K 8D0199382M, 8D0199382S
	<b>VW12071</b> MOTOR TAKOZU SOL VE SAĞ MOTOR TAKOZU	Yön : Sol Ve Sağ Ağırlık : 0.475 kg / 1.047 lb Not : MOTOR TAKOZU	8D0399151H
	<b>AU12035</b> ŞANZIMAN TAKOZU	Ağırlık : 0,490 kg / 1.080 lb	4B0399151L, 4B0399151M 8E0399151D
	<b>VW12041</b> ŞANZIMAN TAKOZU SOL VE SAĞ ŞANZIMAN TAKOZU	Yön : Sol Ve Sağ Ağırlık : 0.307 kg / 0.677 lb Not : ŞANZIMAN TAKOZU	8D0399151J, 8D0399151P
	<b>AU12006</b> SÜSPANSİYON TAKOZU ARKA SOL VE SAĞ	Şasi (Ön / Arka) : ARKA Yön : Sol Ve Sağ Ağırlık : 0.55 kg / 1.213 lb	1J0 512 131 B, 1J0 513 025 Q 1J0512131B, 1J0513025Q
	<b>VW13001</b> DİREKSİYON KÖRÜĞÜ	Ağırlık : 0.065 kg / 0.143 lb	4D0419831
	<b>VW13009</b> DİREKSİYON KÖRÜĞÜ	Ağırlık : 0.19 kg / 0.419 lb	8D0419831J, 8D0419831K
	<b>VW14001</b> AKS KÖRÜĞÜ +KELEPÇE+YAĞ. DIŞ	Ağırlık : 0.14 kg / 0.309 lb	441 407 203A, 441407203A
	<b>VW14008</b> AKS KÖRÜĞÜ +KELEPÇE+YAĞ. DIŞ		3B0407203A
	<b>VW14012</b> AKS KÖRÜĞÜ +KELEPÇE+YAĞ. DIŞ	Ağırlık : 0.175 kg / 0.386 lb	3B0498203A, 4A0498203C 8D0498203A

\* Bu sayfada ve katalogdaki tüm araçların adları, markaları, modelleri, sembolleri, logoları, orjinal numaraları (oe) ve diğer üçüncü parti numaraları sadece referans amaçlı kullanılmaktadır.

**A4**
**8E2, 8E5, B6**
**2000 - 2004**

Resim	Ürün Kodu ve Açıklaması	Detay	OEM
	<b>AU2214</b> ROTBAŞI ÖN SAĞ - SOL RB2214	Ağırlık : 0,594 kg / 1.310 lb Uzunluk : 156 mm / 6.14 inch Gövde Diş Çapı : M14X1,5 Aşık Diş Çapı : M8X1,25 Aşık Konik Çapı : Ø17,5	4B0419811B, 4B0419811C 4B0419811E, 4B0419811F 4D0419811A, 4D0419811B 4D0419811G, 4D0419811H 4F0419811E, 4F0498811
	<b>AU2214A</b> ROTBAŞI SAĞ-SOL (KOMPLE DEMİR) RB2225	Ağırlık : 0,597 kg / 1.316 lb Uzunluk : 156 mm / 6.14 inch Gövde Diş Çapı : M14X1,5 Aşık Diş Çapı : M8X1,25 Aşık Konik Çapı : Ø17,4	4B0419811B, 4D0419811A 4D0419811J, 8E0419811B 8E0419811C
	<b>AU2217</b> ROTBAŞI SAĞ-SOL RB2217	Ağırlık : 0,414 kg / 0.913 lb Uzunluk : 155 mm / 6.10 inch Gövde Diş Çapı : M14X1,5 Aşık Diş Çapı : M8X1,25 Aşık Konik Çapı : Ø17,5	4B0419811G, 4D0419811J 4F0419811C, 4F0419811D 4F0498811, 4F0498811A 8E0419811
	<b>AU3002</b> ROTMİLİ SAĞ-SOL 144 MM RB2814	Ağırlık : 0,445 kg / 0.981 lb Uzunluk : 130 mm / 5.12 inch Gövde Diş Çapı : M16X1,5 Aşık Diş Çapı : M14X1,5	4B0422821, 4D0422821 4D0422821A
	<b>AU3011</b> ROTMİLİ SAĞ-SOL 128 RB2831	Ağırlık : 0.46 kg / 1.014 lb Uzunluk : 130 mm / 5.12 inch Gövde Diş Çapı : M16X1,5 Aşık Diş Çapı : M14X1,5	4E0419821A, 4F0419882 8E0419821, 8E0422801B 8E0422821, 8E0422821C 8E0422822





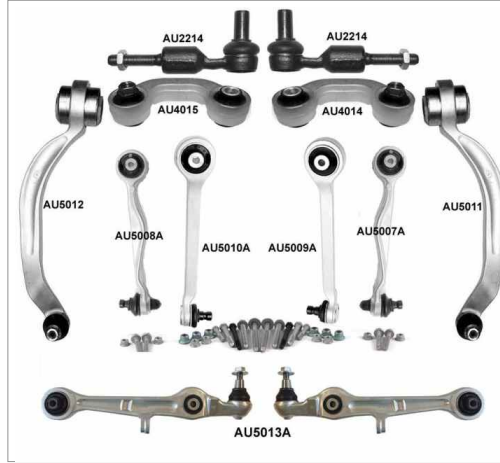







## AU8003 / Süspansiyon Kit Ön

**A4**
**8E2, 8E5, B6**
**2000 - 2004**

**OEM**
**8E0498998**

### Kit Parçaları











Resim	Ürün Kodu / Adı	OEM	OEM	Ürün Kodu / Adı	Resim
	<b>AU2214A</b> Rotbaşı Sağ-sol (komple Demir) Rb2225	4B0419811B, 4D0419811A 4D0419811J, 8E0419811B 8E0419811C	4B0419811B, 4D0419811A 4D0419811J, 8E0419811B 8E0419811C	<b>AU2214A</b> Rotbaşı Sağ-sol (komple Demir) Rb2225	
	<b>AU4014</b> Z Rot Ön Sağ Alüminyum 90 Rb2926	8E0411318	4D0419801B, 8E0411317	<b>AU4015</b> Z Rot Ön Sol Alüminyum 90 Rb2927	
	<b>AU5007A</b> Salıncak Ön Üst Sağ Rb2629	4D0407510B, 4D0407510D 4D0407510F, 4D0407510G 4D0407510H, 4D0407510J 4D0407510K, 8D0407510A 8D0407510C, 8D0407510E	4D0407509F, 4D0407509G 4D0407509J, 4D0407509K 8D0407509C, 8D0407509E 8E0407509A	<b>AU5008A</b> Salıncak Ön Üst Sol Rb2628	
	<b>AU5009A</b> Salıncak Ön Üst Sağ Rb2635	8D0407506A, 8D0407506B 8E0407506A, 8E0407506P	8D0407505A, 8E0407505A 8E0407505P	<b>AU5010A</b> Salıncak Ön Üst Sol Rb2634	
	<b>AU5011</b> Salıncak Ön Alt Sağ Rb2637	4D0407694AC, 4D0407694AD 4D0407694E, 4D0407694H 4D0407694K, 4D0407694M 4D0407694N, 8E0407694 8E0407694AG, 8E0407694E	4D0407693AC, 4D0407693AD 4D0407693E, 4D0407693H 4D0407693K, 4D0407693M 4D0407693N, 8E0407693 8E0407693AG, 8E0407693E	<b>AU5012</b> Salıncak Ön Alt Sol Rb2636	
	<b>AU5013A</b> Salıncak Ön Alt Ön Taraf Sol Ve Sağ Alüminyum Rb2648	8E0407151E, 8E0407151K 8E0407151L, 8E0407151M 8E0407151N, 8E0407151R 8E0407155J	8E0407151E, 8E0407151K 8E0407151L, 8E0407151M 8E0407151N, 8E0407151R 8E0407155J	<b>AU5013A</b> Salıncak Ön Alt Ön Taraf Sol Ve Sağ Alüminyum Rb2648	

**A4 8E2, 8E5, B6 2000 - 2004**

Resim	Ürün Kodu ve Açıklaması	Detay	OEM
	<b>AU22143002</b> ROT TAKIMI ÖN AKS RB288115	Ağırlık : 1,043 kg / 2.299 lb Rotbaşı : AU2214 Rotmili : AU3002	1J0422812A, 4B0419801B 4B0419801E, 4B0419801M 4D0419801B, 4D0419801C 4D0419801D, 4D0419801L
	<b>AU22143011</b> ROT TAKIMI <<ŞASE (ÖN / ARKA)>> ÖN	Ağırlık : 1.026 kg / 2.262 lb Rotbaşı : AU2214 Rotmili : AU3011	8E0419801B
	<b>AU2214A3002</b> ROT TAKIMI ÖN AKS RB288136	Ağırlık : 1,026 kg / 2.262 lb Rotbaşı : AU2214 Rotmili : AU3002	4B0419801G, 4B0419801N 4D0419801Q, 8E0419801B
	<b>AU22173002</b> ROT TAKIMI ÖN	Ağırlık : 0,916 kg / 2.019 lb Rotbaşı : AU2217 Rotmili : AU3002	4B0419801E, 4B0419801G 4F0419811D, 4F0422821D 4F0498811A, 4F0498811C 8E0419801B, 8E0419811
	<b>AU4014</b> Z ROT ÖN SAĞ ALİMİNYUM 90 RB2926	Ağırlık : 0,334 kg / 0.736 lb Malzeme Türü : Alüminyum Uzunluk : 30 mm / 1.18 inch	8E0411318
	<b>AU4015</b> Z ROT ÖN SOL ALİMİNYUM 90 RB2927	Ağırlık : 0,329 kg / 0.725 lb Malzeme Türü : Alüminyum Uzunluk : 30 mm / 1.18 inch	4D0419801B, 8E0411317
	<b>AU4016</b> Z ROT SOL VE SAĞ METAL	Ağırlık : 0,332 kg / 0.732 lb Malzeme Türü : Metal Uzunluk : 90 mm / 3.54 inch Aşık Diş Çapı : M10X1,5	8E0505465A, 8E0505465F 8E0505465K, 8E0505465T
	<b>AU5007A</b> SALINCAK ÖN ÜST SAĞ RB2629	Ağırlık : 0,460 kg / 1.014 lb Malzeme Türü : Alüminyum	4D0407510B, 4D0407510D 4D0407510F, 4D0407510G 4D0407510H, 4D0407510J 4D0407510K, 8D0407510A 8D0407510C, 8D0407510E
	<b>AU5008A</b> SALINCAK ÖN ÜST SOL RB2628	Ağırlık : 0,460 kg / 1.014 lb Malzeme Türü : Alüminyum	4D0407509F, 4D0407509G 4D0407509J, 4D0407509K 8D0407509C, 8D0407509E 8E0407509A
	<b>AU5009A</b> SALINCAK ÖN ÜST SAĞ RB2635	Ağırlık : 0,488 kg / 1.076 lb Malzeme Türü : Alüminyum	8D0407506A, 8D0407506B 8E0407506A, 8E0407506P
	<b>AU5010A</b> SALINCAK ÖN ÜST SOL RB2634	Ağırlık : 0,488 kg / 1.076 lb Malzeme Türü : Alüminyum	8D0407505A, 8E0407505A 8E0407505P











\* Bu sayfada ve katalogdaki tüm araçların adları, markaları, modelleri, sembolleri, logoları, orjinal numaraları (oe) ve diğer üçüncü parti numaraları sadece referans amaçlı kullanılmaktadır.

**A4 8E2, 8E5, B6 2000 - 2004**

Resim	Ürün Kodu ve Açıklaması	Detay	OEM
	<b>AU5011</b> SALINCAK ÖN ALT SAĞ RB2637	Ağırlık : 1,750 kg / 3.858 lb Malzeme Türü : Alüminyum	4D0407694AC, 4D0407694AD 4D0407694E, 4D0407694H 4D0407694K, 4D0407694M 4D0407694N, 8E0407694 8E0407694AG, 8E0407694E
	<b>AU5012</b> SALINCAK ÖN ALT SOL RB2636	Ağırlık : 1,800 kg / 3.968 lb Malzeme Türü : Alüminyum	4D0407693AC, 4D0407693AD 4D0407693E, 4D0407693H 4D0407693K, 4D0407693M 4D0407693N, 8E0407693 8E0407693AG, 8E0407693E
	<b>AU5013A</b> SALINCAK ÖN ALT ÖN TARAF SOL VE SAĞ ALÜMİNYUM RB2648	Ağırlık : 1,504 kg / 3.316 lb Malzeme Türü : Alüminyum	8E0407151E, 8E0407151K 8E0407151L, 8E0407151M 8E0407151N, 8E0407151R 8E0407155J
	<b>AU5085</b> SALINCAK ÖN ÜST ÖNDEN SAĞ	Ağırlık : 0,515 kg / 1.135 lb Malzeme Türü : Alüminyum	8E0407506P
	<b>AU5086</b> SALINCAK ÖN ÜST ÖNDEN SOL	Ağırlık : 0,515 kg / 1.135 lb Malzeme Türü : Alüminyum	8E0407505P
	<b>AU5087</b> SALINCAK ÖN ÜST ARKADAN SAĞ	Ağırlık : 248,3 kg / 547.408 lb Malzeme Türü : Alüminyum	8E0407510P
	<b>AU5088</b> SALINCAK ÖN ÜST ARKADAN SOL	Ağırlık : 248,3 kg / 547.408 lb Malzeme Türü : Alüminyum	8E0407509P
	<b>AU9010</b> SALINCAK ARKA ÜST SAĞ	Ağırlık : 1,47 kg / 3.241 lb Malzeme Türü : Sac Metal	3R0505324, 8E0505324M
	<b>AU9011</b> SALINCAK ARKA ÜST SOL	Ağırlık : 1,47 kg / 3.241 lb Malzeme Türü : Sac Metal	3R0505323, 8E0505323M
	<b>AU11003</b> SALINCAK VE DENGE KOLU BURCU ÖN ÜST SOL VE SAĞ B22115	Şasi (Ön / Arka) : ÖN Yön : Üst Sol Ve Sağ Ağırlık : 0,075 kg / 0.165 lb	4B0407515, 4B0407515A 4D0407515C*, 4D0407515C
	<b>AU11004</b> SALINCAK VE DENGE KOLU BURCU ÖN ORTA SOL VE SAĞ B22112	Şasi (Ön / Arka) : ÖN Yön : Orta Sol Ve Sağ Ağırlık : 0,112 kg / 0.247 lb	4D0407181F, 4D0407181H





\* Bu sayfada ve katalogdaki tüm araçların adları, markaları, modelleri, sembolleri, logoları, orjinal numaraları (oe) ve diğer üçüncü parti numaraları sadece referans amaçlı kullanılmaktadır.

**A4 8E2, 8E5, B6 2000 - 2004**



Resim	Ürün Kodu ve Açıklaması	Detay	OEM
	<b>AU11006</b> SALINCAK VE DENGE KOLU BURCU ÖN SOL VE SAĞ	Şasi (Ön / Arka) : ÖN Yön : Sol Ve Sağ Ağırlık : 0,225 kg / 0.496 lb	4D0407182E, 4D0407182G 8E0407182A, 8E0407182E
	<b>AU11033</b> SALINCAK VE DENGE KOLU BURCU ÖN ALT SOL VE SAĞ B22135	Şasi (Ön / Arka) : ÖN Yön : Alt Sol Ve Sağ Ağırlık : 0,072 kg / 0.159 lb	8E0407181B, 8E0407181C 8E0407181D
	<b>AU11036</b> SALINCAK VE DENGE KOLU BURCU ÖN SOL VE SAĞ	Şasi (Ön / Arka) : ÖN Yön : Sol Ve Sağ Ağırlık : 0,25 kg / 0.551 lb Not : DENGE KOLU BURCU	4H0407515, 8D0407515A 8K0407515, 8R0407515
	<b>AU11062</b> SALINCAK VE DENGE KOLU BURCU ARKA ÜST SOL VE SAĞ	Şasi (Ön / Arka) : ARKA Yön : Üst Sol Ve Sağ Ağırlık : 0.17 kg / 0.375 lb	8E0501541J, 8E0501541K 8E0501541Q, 8E0501541S
	<b>AU11074</b> Z-ROT BURCU ARKA	Şasi (Ön / Arka) : ARKA Ağırlık : 0.05 kg / 0.110 lb Uzunluk : AU4016 mm / 0.00 inch	8E0505465A*, 8E0505465F* 8E0505465K*, 8E0505465T*
	<b>AU11091</b> ROTMİLİ BURCU VE LASTİĞİ		4B0419811E*, 4B0419811F* 4D0419811A*, 4D0419811B* 4F0419811B*, 4F0419811E* 4F0498811*, 8E0419811B*
	<b>AU12029</b> ROTMİLİ BURCU VE LASTİĞİ ÖN	Şasi (Ön / Arka) : ÖN	171419804*, 171419804A* 175419804*
	<b>AU12029K</b> ROTMİLİ BURCU VE LASTİĞİ ÖN	Şasi (Ön / Arka) : ÖN	171419804*, 171419804A* 175419804*
	<b>AU11022</b> TORSİYON BURCU SOL VE SAĞ	Yön : Sol Ve Sağ Ağırlık : 0.59 kg / 1.301 lb	8E0505145AR
	<b>AU12004</b> VİRAJ DEMİR LASTİĞİ SOL VE SAĞ RUBBER	Şasi (Ön / Arka) : ÖN Yön : Sol Ve Sağ Ağırlık : 0.074 kg / 0.163 lb Malzeme Türü : Rubber Not : INTERNAL DIAMETER=Ø29mm	4D0411327J
	<b>AU12004K</b> VİRAJ DEMİR LASTİĞİ SOL VE SAĞ RUBBER	Şasi (Ön / Arka) : ÖN Yön : Sol Ve Sağ Ağırlık : 0.148 kg / 0.326 lb Malzeme Türü : Rubber	4D0411327J

\* Bu sayfada ve katalogdaki tüm araçların adları, markaları, modelleri, sembolleri, logoları, orjinal numaraları (oe) ve diğer üçüncü parti numaraları sadece referans amaçlı kullanılmaktadır.

**A4 8E2, 8E5, B6 2000 - 2004**

Resim	Ürün Kodu ve Açıklaması	Detay	OEM
	<b>AU12005</b> VİRAJ DEMİR LASTİĞİ SOL VE SAĞ RUBBER	Şasi (Ön / Arka) : ÖN Yön : Sol Ve Sağ Ağırlık : 0.06 kg / 0.132 lb Malzeme Türü : Rubber	4D0411327F, 4D0411327H
	<b>AU12005K</b> VİRAJ DEMİR LASTİĞİ SOL VE SAĞ RUBBER	Şasi (Ön / Arka) : ÖN Yön : Sol Ve Sağ Ağırlık : 0.12 kg / 0.265 lb Malzeme Türü : Rubber	4D0411327F, 4D0411327H
	<b>VW14011</b> AKS KÖRÜĞÜ +KELEPÇE+YAĞ. İÇ	Ağırlık : 0.236 kg / 0.520 lb	1K0498201D
	<b>VW14012</b> AKS KÖRÜĞÜ +KELEPÇE+YAĞ. DIŞ	Ağırlık : 0.175 kg / 0.386 lb	3B0498203A, 4A0498203C 8D0498203A





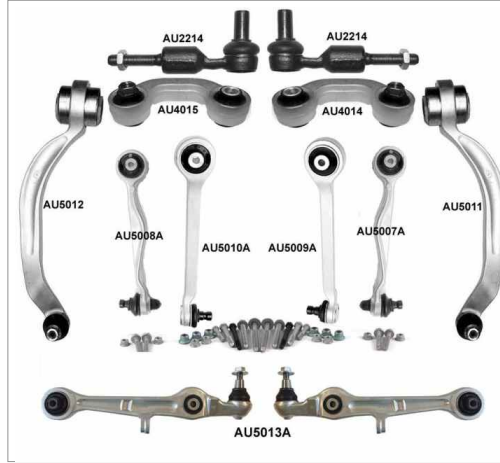





**A4 8EC, B7 2004 - 2008**

Resim	Ürün Kodu ve Açıklaması	Detay	OEM
	<b>AU2217</b> ROTBAŞI SAĞ-SOL RB2217	Ağırlık : 0,414 kg / 0.913 lb Uzunluk : 155 mm / 6.10 inch Gövde Diş Çapı : M14X1,5 Aşık Diş Çapı : M8X1,25 Aşık Konik Çapı : Ø17,5	4B0419811G, 4D0419811J 4F0419811C, 4F0419811D 4F0498811, 4F0498811A 8E0419811
	<b>AU3002</b> ROTMİLİ SAĞ-SOL 144 MM RB2814	Ağırlık : 0,445 kg / 0.981 lb Uzunluk : 130 mm / 5.12 inch Gövde Diş Çapı : M16X1,5 Aşık Diş Çapı : M14X1,5	4B0422821, 4D0422821 4D0422821A
	<b>AU3011</b> ROTMİLİ SAĞ-SOL 128 RB2831	Ağırlık : 0.46 kg / 1.014 lb Uzunluk : 130 mm / 5.12 inch Gövde Diş Çapı : M16X1,5 Aşık Diş Çapı : M14X1,5	4E0419821A, 4F0419882 8E0419821, 8E0422801B 8E0422821, 8E0422821C 8E0422822

**AU8003 / Süspansiyon Kit Ön**
**A4**
**8EC, B7**
**2004 - 2008**

**OEM**
**8E0498998**
**Kit Parçaları**











Resim	Ürün Kodu / Adı	OEM	OEM	Ürün Kodu / Adı	Resim
	<b>AU2214A</b> Rotbaşı Sağ-sol (komple Demir) Rb2225	4B0419811B, 4D0419811A 4D0419811J, 8E0419811B 8E0419811C	4B0419811B, 4D0419811A 4D0419811J, 8E0419811B 8E0419811C	<b>AU2214A</b> Rotbaşı Sağ-sol (komple Demir) Rb2225	
	<b>AU4014</b> Z Rot Ön Sağ Alüminyum 90 Rb2926	8E0411318	4D0419801B, 8E0411317	<b>AU4015</b> Z Rot Ön Sol Alüminyum 90 Rb2927	
	<b>AU5007A</b> Salıncak Ön Üst Sağ Rb2629	4D0407510B, 4D0407510D 4D0407510F, 4D0407510G 4D0407510H, 4D0407510J 4D0407510K, 8D0407510A 8D0407510C, 8D0407510E	4D0407509F, 4D0407509G 4D0407509J, 4D0407509K 8D0407509C, 8D0407509E 8E0407509A	<b>AU5008A</b> Salıncak Ön Üst Sol Rb2628	
	<b>AU5009A</b> Salıncak Ön Üst Sağ Rb2635	8D0407506A, 8D0407506B 8E0407506A, 8E0407506P	8D0407505A, 8E0407505A 8E0407505P	<b>AU5010A</b> Salıncak Ön Üst Sol Rb2634	
	<b>AU5011</b> Salıncak Ön Alt Sağ Rb2637	4D0407694AC, 4D0407694AD 4D0407694E, 4D0407694H 4D0407694K, 4D0407694M 4D0407694N, 8E0407694 8E0407694AG, 8E0407694E	4D0407693AC, 4D0407693AD 4D0407693E, 4D0407693H 4D0407693K, 4D0407693M 4D0407693N, 8E0407693 8E0407693AG, 8E0407693E	<b>AU5012</b> Salıncak Ön Alt Sol Rb2636	
	<b>AU5013A</b> Salıncak Ön Alt Ön Taraf Sol Ve Sağ Alüminyum Rb2648	8E0407151E, 8E0407151K 8E0407151L, 8E0407151M 8E0407151N, 8E0407151R 8E0407155J	8E0407151E, 8E0407151K 8E0407151L, 8E0407151M 8E0407151N, 8E0407151R 8E0407155J	<b>AU5013A</b> Salıncak Ön Alt Ön Taraf Sol Ve Sağ Alüminyum Rb2648	

**A4**
**8EC, B7**
**2004 - 2008**

Resim	Ürün Kodu ve Açıklaması	Detay	OEM
	<b>AU22173002</b> ROT TAKIMI ÖN	Ağırlık : 0,916 kg / 2.019 lb Rotbaşı : AU2217 Rotmilii : AU3002	4B0419801E, 4B0419801G 4F0419811D, 4F0422821D 4F0498811A, 4F0498811C 8E0419801B, 8E0419811
	<b>AU22173011</b> ROT TAKIMI ÖN AKS	Ağırlık : 0,97 kg / 2.138 lb Rotbaşı : AU2217 Rotmilii : AU3011	8E0419801E, 8E0419801N
	<b>AU4014</b> Z ROT ÖN SAĞ ALİMİNYUM 90 RB2926	Ağırlık : 0,334 kg / 0.736 lb Malzeme Türü : Alüminyum Uzunluk : 30 mm / 1.18 inch	8E0411318
	<b>AU4015</b> Z ROT ÖN SOL ALİMİNYUM 90 RB2927	Ağırlık : 0,329 kg / 0.725 lb Malzeme Türü : Alüminyum Uzunluk : 30 mm / 1.18 inch	4D0419801B, 8E0411317
	<b>AU4016</b> Z ROT SOL VE SAĞ METAL	Ağırlık : 0,332 kg / 0.732 lb Malzeme Türü : Metal Uzunluk : 90 mm / 3.54 inch Aşık Diş Çapı : M10X1,5	8E0505465A, 8E0505465F 8E0505465K, 8E0505465T
	<b>AU5007A</b> SALINCAK ÖN ÜST SAĞ RB2629	Ağırlık : 0,460 kg / 1.014 lb Malzeme Türü : Alüminyum	4D0407510B, 4D0407510D 4D0407510F, 4D0407510G 4D0407510H, 4D0407510J 4D0407510K, 8D0407510A 8D0407510C, 8D0407510E
	<b>AU5008A</b> SALINCAK ÖN ÜST SOL RB2628	Ağırlık : 0,460 kg / 1.014 lb Malzeme Türü : Alüminyum	4D0407509F, 4D0407509G 4D0407509J, 4D0407509K 8D0407509C, 8D0407509E 8E0407509A
	<b>AU5009A</b> SALINCAK ÖN ÜST SAĞ RB2635	Ağırlık : 0,488 kg / 1.076 lb Malzeme Türü : Alüminyum	8D0407506A, 8D0407506B 8E0407506A, 8E0407506P
	<b>AU5010A</b> SALINCAK ÖN ÜST SOL RB2634	Ağırlık : 0,488 kg / 1.076 lb Malzeme Türü : Alüminyum	8D0407505A, 8E0407505A 8E0407505P
	<b>AU5011</b> SALINCAK ÖN ALT SAĞ RB2637	Ağırlık : 1,750 kg / 3.858 lb Malzeme Türü : Alüminyum	4D0407694AC, 4D0407694AD 4D0407694E, 4D0407694H 4D0407694K, 4D0407694M 4D0407694N, 8E0407694 8E0407694AG, 8E0407694E
	<b>AU5012</b> SALINCAK ÖN ALT SOL RB2636	Ağırlık : 1,800 kg / 3.968 lb Malzeme Türü : Alüminyum	4D0407693AC, 4D0407693AD 4D0407693E, 4D0407693H 4D0407693K, 4D0407693M 4D0407693N, 8E0407693 8E0407693AG, 8E0407693E

\* Bu sayfada ve katalogdaki tüm araçların adları, markaları, modelleri, sembolleri, logoları, orjinal numaraları (oe) ve diğer üçüncü parti numaraları sadece referans amaçlı kullanılmaktadır.

**A4**
**8EC, B7**
**2004 - 2008**

Resim	Ürün Kodu ve Açıklaması	Detay	OEM
	<b>AU5013</b> SALINCAK ÖN ALT ÖN TARAF SOL VE SAĞ ALÜMİNYUM RB2616	Ağırlık : 1,520 kg / 3.351 lb Malzeme Türü : Alüminyum	4B3407151C, 4B3407151E 4D0407151G, 4D0407151H 4D0407151J
	<b>AU5058</b> SALINCAK ÖN SAĞ ALT	Malzeme Türü : Alüminyum	8E0407694AA, 8E0407694AC 8E0407694AD, 8E0407694AF 8E0407694AJ, 8E0407694AK 8E0407694AL, 8E0407694AM 8E0407694T
	<b>AU5059</b> SALINCAK ÖN SOL ALT	Malzeme Türü : Alüminyum	8E0407693AA, 8E0407693AC 8E0407693AD, 8E0407693AF 8E0407693AJ, 8E0407693AK 8E0407693AL, 8E0407693AM 8E0407693T
	<b>AU5085</b> SALINCAK ÖN ÜST ÖNDEN SAĞ	Ağırlık : 0,515 kg / 1.135 lb Malzeme Türü : Alüminyum	8E0407506P
	<b>AU5086</b> SALINCAK ÖN ÜST ÖNDEN SOL	Ağırlık : 0,515 kg / 1.135 lb Malzeme Türü : Alüminyum	8E0407505P
	<b>AU5087</b> SALINCAK ÖN ÜST ARKADAN SAĞ	Ağırlık : 248,3 kg / 547.408 lb Malzeme Türü : Alüminyum	8E0407510P
	<b>AU5088</b> SALINCAK ÖN ÜST ARKADAN SOL	Ağırlık : 248,3 kg / 547.408 lb Malzeme Türü : Alüminyum	8E0407509P
	<b>AU9010</b> SALINCAK ARKA ÜST SAĞ	Ağırlık : 1,47 kg / 3.241 lb Malzeme Türü : Sac Metal	3R0505324, 8E0505324M
	<b>AU9011</b> SALINCAK ARKA ÜST SOL	Ağırlık : 1,47 kg / 3.241 lb Malzeme Türü : Sac Metal	3R0505323, 8E0505323M
	<b>AU11003</b> SALINCAK VE DENGE KOLU BURCU ÖN ÜST SOL VE SAĞ B22115	Şasi (Ön / Arka) : ÖN Yön : Üst Sol Ve Sağ Ağırlık : 0,075 kg / 0.165 lb	4B0407515, 4B0407515A 4D0407515C*, 4D0407515C
	<b>AU11006</b> SALINCAK VE DENGE KOLU BURCU ÖN SOL VE SAĞ	Şasi (Ön / Arka) : ÖN Yön : Sol Ve Sağ Ağırlık : 0,225 kg / 0.496 lb	4D0407182E, 4D0407182G 8E0407182A, 8E0407182E

\* Bu sayfada ve katalogdaki tüm araçların adları, markaları, modelleri, sembolleri, logoları, orjinal numaraları (oe) ve diğer üçüncü parti numaraları sadece referans amaçlı kullanılmaktadır.



**A4**
**8EC, B7**
**2004 - 2008**





Resim	Ürün Kodu ve Açıklaması	Detay	OEM
	<b>AU11007</b> SALINCAK VE DENGE KOLU BURCU ÖN ALT SOL VE SAĞ	Şasi (Ön / Arka) : ÖN Yön : Alt Sol Ve Sağ Ağırlık : 0,59 kg / 1.301 lb	4D0407183AB, 4D0407183AC 4D0407183D, 4D0407183M 4D0407183N, 4D0407183P 4D0407183S
	<b>AU11032</b> SALINCAK VE DENGE KOLU BURCU ÖN SOL VE SAĞ	Şasi (Ön / Arka) : ÖN Yön : Sol Ve Sağ Ağırlık : 0,17 kg / 0.375 lb Not : DENGE KOLU BURCU	4D0407183L, 4F0407183A 4F0407183B, 4F0407183E
	<b>AU11033</b> SALINCAK VE DENGE KOLU BURCU ÖN ALT SOL VE SAĞ B22135	Şasi (Ön / Arka) : ÖN Yön : Alt Sol Ve Sağ Ağırlık : 0,072 kg / 0.159 lb	8E0407181B, 8E0407181C 8E0407181D
	<b>AU11036</b> SALINCAK VE DENGE KOLU BURCU ÖN SOL VE SAĞ	Şasi (Ön / Arka) : ÖN Yön : Sol Ve Sağ Ağırlık : 0,25 kg / 0.551 lb Not : DENGE KOLU BURCU	4H0407515, 8D0407515A 8K0407515, 8R0407515
	<b>AU11062</b> SALINCAK VE DENGE KOLU BURCU ARKA ÜST SOL VE SAĞ	Şasi (Ön / Arka) : ARKA Yön : Üst Sol Ve Sağ Ağırlık : 0,17 kg / 0.375 lb	8E0501541J, 8E0501541K 8E0501541Q, 8E0501541S
	<b>VW11052</b> SALINCAK VE DENGE KOLU BURCU ALT SOL VE SAĞ B22130	Yön : Alt Sol Ve Sağ Ağırlık : 0,523 kg / 1.153 lb	4D0407183M, 4D0407183N 4D0407183P, 4D0407183Q 4E0407183M
	<b>AU11074</b> Z-ROT BURCU ARKA	Şasi (Ön / Arka) : ARKA Ağırlık : 0,05 kg / 0.110 lb Uzunluk : AU4016 mm / 0.00 inch	8E0505465A*, 8E0505465F* 8E0505465K*, 8E0505465T*
	<b>AU12029</b> ROTMİLİ BURCU VE LASTİĞİ ÖN	Şasi (Ön / Arka) : ÖN	171419804*, 171419804A* 175419804*
	<b>AU12029K</b> ROTMİLİ BURCU VE LASTİĞİ ÖN	Şasi (Ön / Arka) : ÖN	171419804*, 171419804A* 175419804*
	<b>AU12004</b> VİRAJ DEMİR LASTİĞİ SOL VE SAĞ RUBBER	Şasi (Ön / Arka) : ÖN Yön : Sol Ve Sağ Ağırlık : 0,074 kg / 0.163 lb Malzeme Türü : Rubber Not : INTERNAL DIAMETER=Ø29mm	4D0411327J
	<b>AU12004K</b> VİRAJ DEMİR LASTİĞİ SOL VE SAĞ RUBBER	Şasi (Ön / Arka) : ÖN Yön : Sol Ve Sağ Ağırlık : 0,148 kg / 0.326 lb Malzeme Türü : Rubber	4D0411327J

\* Bu sayfada ve katalogdaki tüm araçların adları, markaları, modelleri, sembolleri, logoları, orjinal numaraları (oe) ve diğer üçüncü parti numaraları sadece referans amaçlı kullanılmaktadır.

**A4 8EC, B7 2004 - 2008**

Resim	Ürün Kodu ve Açıklaması	Detay	OEM
	<b>VW14011</b> AKS KÖRÜĞÜ +KELEPÇE+YAĞ. İÇ	Ağırlık : 0.236 kg / 0.520 lb	1K0498201D





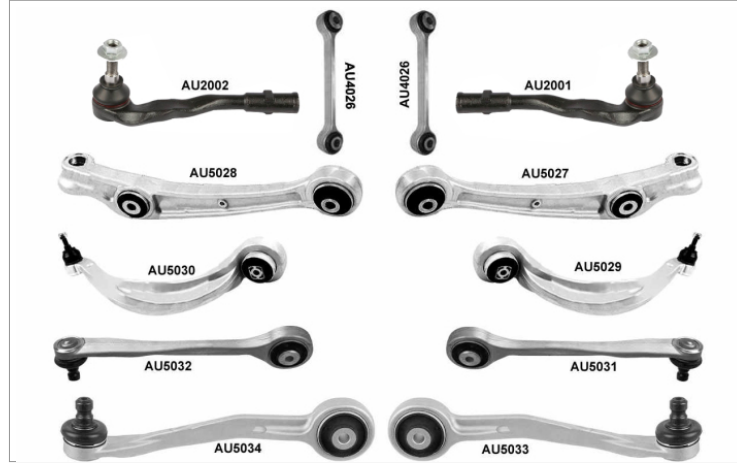





**A4 8K2, 8K5 2007 - 2015**

Resim	Ürün Kodu ve Açıklaması	Detay	OEM
	<b>AU1016</b> ROTİL ÖN ALT SAĞ - SOL Ø13,8 RB2411	Ağırlık : 0,5 kg / 1.102 lb Konik Ölçüsü : Ø13,8 Aşık Diş Çapı : M12X1,5 Rotil Gövde Çapı : Ø42	8K0407689E, 8K0407689F 8K0407689G
	<b>AU1019</b> ROTİL ÖN ALT SAĞ - SOL Ø17	Ağırlık : 0,505 kg / 1.113 lb Konik Ölçüsü : Ø17 Aşık Diş Çapı : M14X1,5 Rotil Gövde Çapı : Ø42	4G0407689A, 4G0407689C 8W0407689B
	<b>AU2001</b> ROTBAŞI SAĞ	Ağırlık : 0,801 kg / 1.766 lb Uzunluk : 206 mm / 8.11 inch Gövde Diş Çapı : M16X1,5 Aşık Diş Çapı : M12X1,5 Aşık Konik Çapı : Ø14,6	8K0422818A, 8K0422818B
	<b>AU2002</b> ROTBAŞI SOL	Ağırlık : 0,801 kg / 1.766 lb Uzunluk : 206 mm / 8.11 inch Gövde Diş Çapı : M16X1,5 Aşık Diş Çapı : M12X1,5 Aşık Konik Çapı : Ø14,6	8K0422817A, 8K0422817B
	<b>AU3007</b> ROTMİLİ	Ağırlık : 0,484 kg / 1.067 lb Uzunluk : 225 mm / 8.86 inch Gövde Diş Çapı : M16X1,5 Aşık Diş Çapı : M16X1,5	8J0423810

**AU8005 / Süspansiyon Kit Ön**
**A4**
**8K2, 8K5**
**2007 - 2015**

**Kit Parçaları**











Resim	Ürün Kodu / Adı	OEM	OEM	Ürün Kodu / Adı	Resim
	<b>AU2001</b> Rotbaşı Sağ	8K0422818A, 8K0422818B	8K0422817A, 8K0422817B	<b>AU2002</b> Rotbaşı Sol	
	<b>AU4026</b> Z Rot Ön Denge Rotu 170 Rb2944	8K0411317C, 8K0411317D 8K0411317E	8K0411317C, 8K0411317D 8K0411317E	<b>AU4026</b> Z Rot Ön Denge Rotu 170 Rb2944	
	<b>AU5027</b> Salıncak Ön Alt Sağ	8K0407152B, 8K0407152C 8K0407152D	8K0407151B	<b>AU5028</b> Salıncak Ön Alt Sol	
	<b>AU5029</b> Salıncak Ön Alt Sağ	8K0407694F, 8K0407694N	8K0407693F, 8K0407693N	<b>AU5030</b> Salıncak Ön Alt Sol	
	<b>AU5031</b> Salıncak Ön Üst Sağ	8K0407506A	8K0407505A	<b>AU5032</b> Salıncak Ön Üst Sol	
	<b>AU5033</b> Salıncak Ön Üst Sağ	8K0407510A	8K0407509, 8K0407509A	<b>AU5034</b> Salıncak Ön Üst Sol	

**A4**
**8K2, 8K5**
**2007 - 2015**

Resim	Ürün Kodu ve Açıklaması	Detay	OEM
	<b>AU20013007</b> ROT TAKIMI ÖN AKS SAĞ	Ağırlık : 1,29 kg / 2.844 lb Rotbaşı : AU2001 Rotmili : AU3007	
	<b>AU20023007</b> ROT TAKIMI ÖN AKS SOL	Ağırlık : 1,29 kg / 2.844 lb Rotbaşı : AU2002 Rotmili : AU3007	
	<b>AU4023</b> Z ROT SOL VE SAĞ PLASTİK RB2947	Ağırlık : 0,117 kg / 0.258 lb Malzeme Türü : Plastik Uzunluk : 62 mm / 2.44 inch	8K0505465E, 8K0505465G
	<b>AU4024</b> Z ROT ARKA SAĞ	Ağırlık : 0,508 kg / 1.120 lb Uzunluk : 282,5 mm / 11.12 inch	8K0501530K, 8K0501530N
	<b>AU4025</b> Z ROT ARKA SOL	Ağırlık : 0,508 kg / 1.120 lb Uzunluk : 282,5 mm / 11.12 inch	8K0501529K, 8K0501529N
	<b>AU4026</b> Z ROT ÖN DENGE ROTU 170 RB2944	Ağırlık : 0,185 kg / 0.408 lb Malzeme Türü : Denge Rotu Uzunluk : 170 mm / 6.69 inch	8K0411317C, 8K0411317D 8K0411317E
	<b>AU4030</b> Z ROT ÖN ALÜMİNYUM L=110	Ağırlık : 0,151 kg / 0.333 lb Malzeme Türü : Alüminyum Uzunluk : 110 mm / 4.33 inch	8K0411317B
	<b>AU4031</b> Z ROT ÖN ALÜMİNYUM L=170	Ağırlık : 0,201 kg / 0.443 lb Malzeme Türü : Alüminyum Uzunluk : 170 mm / 6.69 inch	4G0411317A, 4G0411317C 4M0411317
	<b>AU5027</b> SALINCAK ÖN ALT SAĞ	Malzeme Türü : Alüminyum	8K0407152B, 8K0407152C 8K0407152D
	<b>AU5028</b> SALINCAK ÖN ALT SOL	Malzeme Türü : Alüminyum	8K0407151B
	<b>AU5029</b> SALINCAK ÖN ALT SAĞ	Malzeme Türü : Alüminyum	8K0407694F, 8K0407694N











\* Bu sayfada ve katalogdaki tüm araçların adları, markaları, modelleri, sembolleri, logoları, orjinal numaraları (oe) ve diğer üçüncü parti numaraları sadece referans amaçlı kullanılmaktadır.

**A4**
**8K2, 8K5**
**2007 - 2015**

Resim	Ürün Kodu ve Açıklaması	Detay	OEM
	<b>AU5030</b> SALINCAK ÖN ALT SOL	Malzeme Türü : Alüminyum	8K0407693F, 8K0407693N
	<b>AU5031</b> SALINCAK ÖN ÜST SAĞ	Malzeme Türü : Alüminyum	8K0407506A
	<b>AU5032</b> SALINCAK ÖN ÜST SOL	Malzeme Türü : Alüminyum	8K0407505A
	<b>AU5033</b> SALINCAK ÖN ÜST SAĞ	Malzeme Türü : Alüminyum	8K0407510A
	<b>AU5034</b> SALINCAK ÖN ÜST SOL	Malzeme Türü : Alüminyum	8K0407509, 8K0407509A
	<b>AU5049</b> SALINCAK ÖN ALT SAĞ	Malzeme Türü : Alüminyum	8K0407152F, 8K0407152G
	<b>AU5050</b> SALINCAK ÖN ALT SOL	Malzeme Türü : Alüminyum	8K0407151F, 8K0407151G
	<b>AU5053</b> SALINCAK ÖN SAĞ	Malzeme Türü : Alüminyum	8K0407694S, 8K0407694T
	<b>AU5054</b> SALINCAK ÖN SOL	Malzeme Türü : Alüminyum	8K0407693Q, 8K0407693T
	<b>AU5062</b> SALINCAK ÖN ALT SAĞ	Ağırlık : 1,3 kg / 2.866 lb Malzeme Türü : Alüminyum	8K0407152B, 8K0407152C 8K0407152D, 8K0407152E
	<b>AU5063</b> SALINCAK ÖN ALT SOL	Ağırlık : 1,3 kg / 2.866 lb Malzeme Türü : Alüminyum	8K0407151D

\* Bu sayfada ve katalogdaki tüm araçların adları, markaları, modelleri, sembolleri, logoları, orjinal numaraları (oe) ve diğer üçüncü parti numaraları sadece referans amaçlı kullanılmaktadır.

**A4**
**8K2, 8K5**
**2007 - 2015**









Resim	Ürün Kodu ve Açıklaması	Detay	OEM
	<b>AU5073</b> SALINCAK ÖN ALT SAĞ	Ağırlık : 2,330 kg / 5.137 lb Malzeme Türü : Alüminyum	8K0407694AD, 8K0407694Q 8K0407694S, 8R0407694B 8R0407694D, 9A740769403
	<b>AU5074</b> SALINCAK ÖN ALT SOL	Ağırlık : 2,330 kg / 5.137 lb Malzeme Türü : Alüminyum	8K0407693AD, 8K0407693Q 8K0407693S, 8R0407693B 8R0407693D, 9A740769303
	<b>AU9001</b> SALINCAK ARKA	Ağırlık : 0,546 kg / 1.204 lb Malzeme Türü : Sac Metal	8K0501529L
	<b>AU9002</b> SALINCAK ARKA	Ağırlık : 1,95 kg / 4.299 lb Malzeme Türü : Sac Metal	8E0501529F, 8E0501529G 8E0501529K, 8E0501529L 8E0501529P
	<b>AU11036</b> SALINCAK VE DENGE KOLU BURCU ÖN SOL VE SAĞ	Şasi (Ön / Arka) : ÖN Yön : Sol Ve Sağ Ağırlık : 0,25 kg / 0.551 lb Not : DENGE KOLU BURCU	4H0407515, 8D0407515A 8K0407515, 8R0407515
	<b>AU11043</b> SALINCAK VE DENGE KOLU BURCU ÖN ALT ORTA SOL VE SAĞ B22137	Şasi (Ön / Arka) : ÖN Yön : Alt Orta Sol Ve Sağ Ağırlık : 0,1 kg / 0.220 lb	4E0407181B
	<b>AU11044</b> SALINCAK VE DENGE KOLU BURCU ALT ORTA SOL VE SAĞ	Yön : Alt Orta Sol Ve Sağ Ağırlık : 0,1 kg / 0.220 lb	4E0407183B
	<b>AU11045</b> SALINCAK VE DENGE KOLU BURCU ÜST SOL VE SAĞ	Yön : Üst Sol Ve Sağ Ağırlık : 0,1 kg / 0.220 lb	4E0407515D, 8D0407515B 8K0407515
	<b>AU11054</b> SALINCAK VE DENGE KOLU BURCU SOL VE SAĞ	Yön : Sol Ve Sağ Ağırlık : 0,172 kg / 0.379 lb Not : SALINCAK BURCU	8K0407151B*, 8K0407151B 8K0407152B*
	<b>AU11055</b> SALINCAK VE DENGE KOLU BURCU ALT SOL VE SAĞ	Yön : Alt Sol Ve Sağ Ağırlık : 0,29 kg / 0.639 lb Not : SALINCAK BURCU	8K0407183A, 8K0407183B
	<b>AU11090</b> SALINCAK VE DENGE KOLU BURCU ÖN ALT	Şasi (Ön / Arka) : ÖN Yön : Alt Ağırlık : 0,595 kg / 1.312 lb Not : HYDRAULIC	8K0407183D, 8K0407183F 8W0404693B

\* Bu sayfada ve katalogdaki tüm araçların adları, markaları, modelleri, sembolleri, logoları, orjinal numaraları (oe) ve diğer üçüncü parti numaraları sadece referans amaçlı kullanılmaktadır.

**A4**
**8K2, 8K5**
**2007 - 2015**











Resim	Ürün Kodu ve Açıklaması	Detay	OEM
	<b>AU11025</b> Z-ROT BURCU ARKA SOL VE SAĞ	Şasi (Ön / Arka) : ARKA Yön : Sol Ve Sağ Ağırlık : 0.032 kg / 0.071 lb Uzunluk : AU4023 mm / 0.00 inch	8K0505465E*, 8K0505465G*
	<b>AU11053</b> Z-ROT BURCU SOL VE SAĞ	Yön : Sol Ve Sağ Ağırlık : 0,082 kg / 0.181 lb Uzunluk : AU9001 mm / 0.00 inch Aşık Dış Çapı : AU4024 Not : AU4025	8K0501529N*, 8K0501530N*
	<b>AU12050</b> VİRAJ DEMİR LASTİĞİ	Şasi (Ön / Arka) : ÖN Ağırlık : 0,059 kg / 0.130 lb	8K0411327A
	<b>AU12050K</b> VİRAJ DEMİR LASTİĞİ	Şasi (Ön / Arka) : ÖN Ağırlık : 0,118 kg / 0.260 lb	8K0411327A
	<b>AU12032</b> MOTOR TAKOZU ÖN MERKEZ	Şasi (Ön / Arka) : ÖN Yön : Merkez Ağırlık : 0,675 kg / 1.488 lb	8K0399151AQ, 8K0399151BD
	<b>AU12048</b> ŞANZIMAN TAKOZU ARKA ORTA	Şasi (Ön / Arka) : ARKA Yön : Orta Ağırlık : 0,641 kg / 1.413 lb	8K0399151BF, 8K0399151CD 8K0399151DB
	<b>AU12038</b> SÜSPANSİYON TAKOZU ARKA	Şasi (Ön / Arka) : ARKA Ağırlık : 0,095 kg / 0.209 lb	8K0512131B, 8T0513028AB 8T0513028R, 8T0513029 8T0513029A
	<b>AU12039</b> SÜSPANSİYON TAKOZU ÖN	Şasi (Ön / Arka) : ÖN Ağırlık : 0,075 kg / 0.165 lb	8K0412131E
	<b>AU12040</b> SÜSPANSİYON TAKOZU ÖN	Şasi (Ön / Arka) : ÖN Ağırlık : 0,075 kg / 0.165 lb	8K0412131F
	<b>F114009</b> AKS KÖRÜĞÜ +KELEPÇE+YAĞ. DIŞ	Ağırlık : 0.207 kg / 0.456 lb	46307716
	<b>OP14017</b> AKS KÖRÜĞÜ +KELEPÇE+YAĞ. DIŞ	Ağırlık : 0.17 kg / 0.375 lb	1603277

\* Bu sayfada ve katalogdaki tüm araçların adları, markaları, modelleri, sembolleri, logoları, orjinal numaraları (oe) ve diğer üçüncü parti numaraları sadece referans amaçlı kullanılmaktadır.

A4	8W2, B9	2015 -	
Resim	Ürün Kodu ve Açıklaması	Detay	OEM
	<b>AU1019</b> ROTİL ÖN ALT SAĞ - SOL Ø17	Ağırlık : 0,505 kg / 1.113 lb Konik Ölçüsü : Ø17 Aşık Diş Çapı : M14X1,5 Rotil Gövde Çapı : Ø42	4G0407689A, 4G0407689C 8W0407689B
	<b>AU2027</b> ROTBAŞI ÖN SAĞ	Ağırlık : 0,812 kg / 1.790 lb Uzunluk : 216 mm / 8.50 inch Gövde Diş Çapı : M16X1,5 Aşık Diş Çapı : M14X1,5	8W0423812B, 8W0423812C
	<b>AU2028</b> ROTBAŞI ÖN SOL	Ağırlık : 0,812 kg / 1.790 lb Uzunluk : 216 mm / 8.50 inch Gövde Diş Çapı : M16X1,5 Aşık Diş Çapı : M14X1,5	8W0423811B, 8W0423811C
	<b>AU3014</b> ROTMİLİ ÖN SAĞ - SOL	Ağırlık : 0,533 kg / 1.175 lb	8W0423810A
	<b>AU4035</b> Z ROT SOL VE SAĞ	Ağırlık : 0,281 kg / 0.619 lb Uzunluk : 174,5 mm / 6.87 inch	4N0505465F, 8W0505465B
	<b>AU5064</b> SALINCAK ÖN ALT SAĞ	Ağırlık : 1,280 kg / 2.822 lb Malzeme Türü : Alüminyum	8W0407152A
	<b>AU5065</b> SALINCAK ÖN ALT SOL	Ağırlık : 1,280 kg / 2.822 lb Malzeme Türü : Alüminyum	8W0407151A
	<b>AU5066</b> SALINCAK ÖN SAĞ ÜST	Ağırlık : 0,450 kg / 0.992 lb Malzeme Türü : Alüminyum	8W0407509A, 8W0407509B 8W0407509E, 8W0407510 8W0407510A, 8W0407510B 8W0407510E, 8WD407509
	<b>AU5067</b> SALINCAK ÖN SOL ÜST	Ağırlık : 0,450 kg / 0.992 lb Malzeme Türü : Alüminyum	
	<b>AU5068</b> SALINCAK ÖN SAĞ ÜST	Ağırlık : 0,484 kg / 1.067 lb Malzeme Türü : Alüminyum	8W0407506, 8W0407506A 8W0407506C
	<b>AU5069</b> SALINCAK ÖN SOL ÜST	Ağırlık : 0,484 kg / 1.067 lb Malzeme Türü : Alüminyum	8W0407505, 8W0407505A 8W0407505C











\* Bu sayfada ve katalogdaki tüm araçların adları, markaları, modelleri, sembolleri, logoları, orjinal numaraları (oe) ve diğer üçüncü parti numaraları sadece referans amaçlı kullanılmaktadır.



A4	8W2, B9	2015 -	
Resim	Ürün Kodu ve Açıklaması	Detay	OEM
	<b>AU5071</b> SALINCAK ÖN ALT ARKADAN SAĞ	Ağırlık : 2,150 kg / 4.740 lb Malzeme Türü : Alüminyum	8W0407694A, 8W0407694B 8WD407694
	<b>AU5072</b> SALINCAK ÖN ALT ARKADAN SOL	Ağırlık : 2,150 kg / 4.740 lb Malzeme Türü : Alüminyum	8W0407693A, 8W0407693B 8WD407693
	<b>AU9016</b> SALINCAK ÜST SAĞ	Ağırlık : 0,926 kg / 2.041 lb Malzeme Türü : Alüminyum	8W0505324F
	<b>AU9017</b> SALINCAK ÜST SOL	Ağırlık : 0,926 kg / 2.041 lb Malzeme Türü : Alüminyum	8W0505323F
	<b>AU9020</b> SALINCAK ARKA ALT ARKADAN SAĞ	Ağırlık : 0,708 kg / 1.561 lb Malzeme Türü : Sac Metal	4M0505292D, 80A505292
	<b>AU9021</b> SALINCAK ARKA ALT ARKADAN SOL	Ağırlık : 0,708 kg / 1.561 lb Malzeme Türü : Sac Metal	4M0505291D, 80A505291
	<b>AU9025</b> SALINCAK ALT SAĞ	Ağırlık : 0,883 kg / 1.947 lb Malzeme Türü : Sac Metal	8W0501530D
	<b>AU9026</b> SALINCAK ALT SOL	Ağırlık : 0,883 kg / 1.947 lb Malzeme Türü : Sac Metal	8W0501529D
	<b>AU9027</b> SALINCAK ARKA ÜST ARKADAN SAĞ	Ağırlık : 1,416 kg / 3.122 lb Malzeme Türü : Sac Metal	8W0505398C, 8W0505398F
	<b>AU9028</b> SALINCAK ARKA ÜST ARKADAN SOL	Ağırlık : 1,416 kg / 3.122 lb Malzeme Türü : Sac Metal	8W0505397C, 8W0505397F
	<b>AU11043</b> SALINCAK VE DENGE KOLU BURCU ÖN ALT ORTA SOL VE SAĞ B22137	Şasi (Ön / Arka) : ÖN Yön : Alt Orta Sol Ve Sağ Ağırlık : 0,1 kg / 0.220 lb	4E0407181B



\* Bu sayfada ve katalogdaki tüm araçların adları, markaları, modelleri, sembolleri, logoları, orjinal numaraları (oe) ve diğer üçüncü parti numaraları sadece referans amaçlı kullanılmaktadır.

**A4**
**8W2, B9**
**2015 -**







Resim	Ürün Kodu ve Açıklaması	Detay	OEM
	<b>AU11054</b> SALINCAK VE DENGE KOLU BURCU SOL VE SAĞ	Yön : Sol Ve Sağ Ağırlık : 0,172 kg / 0.379 lb Not : SALINCAK BURCU	8K0407151B*, 8K0407151B 8K0407152B*
	<b>AU11072</b> SALINCAK VE DENGE KOLU BURCU ARKA ALT	Şasi (Ön / Arka) : ARKA Yön : Alt Ağırlık : 0,250 kg / 0.551 lb	4M0501529L*, 4M0501529N* 4M0501530N*
	<b>AU11077</b> SALINCAK VE DENGE KOLU BURCU ARKA ALT	Şasi (Ön / Arka) : ARKA Yön : Alt Ağırlık : 0,125 kg / 0.276 lb	8W0501529D*, 8W0501530D*
	<b>AU11078</b> SALINCAK VE DENGE KOLU BURCU ARKA ARKA ÜST ARKADAN	Şasi (Ön / Arka) : ARKA Yön : Arka Üst Arkadan Ağırlık : 0,115 kg / 0.254 lb	8W0505397C*, 8W0505397F* 8W0505398C*, 8W0505398F*
	<b>AU11081</b> SALINCAK VE DENGE KOLU BURCU ARKA DIŞ ÜST	Şasi (Ön / Arka) : ARKA Yön : Dış Üst Ağırlık : 0,095 kg / 0.209 lb	8W0505323F*, 8W0505324F*
	<b>AU11082</b> SALINCAK VE DENGE KOLU BURCU ARKA ÜST MERKEZ	Şasi (Ön / Arka) : ARKA Yön : Üst Merkez Ağırlık : 0,050 kg / 0.110 lb	8W0505323F*, 8W0505324F*
	<b>AU11083</b> SALINCAK VE DENGE KOLU BURCU ARKA İÇ ÜST	Şasi (Ön / Arka) : ARKA Yön : İç Üst Ağırlık : 0,105 kg / 0.231 lb	8W0505323F*, 8W0505324F*
	<b>AU11089</b> SALINCAK VE DENGE KOLU BURCU ÖN ÜST	Şasi (Ön / Arka) : ÖN Yön : Üst Ağırlık : 0.11 kg / 0.243 lb	8W0407505C, 8W0407506C 8W0407509B, 8W0407515
	<b>AU11090</b> SALINCAK VE DENGE KOLU BURCU ÖN ALT	Şasi (Ön / Arka) : ÖN Yön : Alt Ağırlık : 0,595 kg / 1.312 lb Not : HYDRAULIC	8K0407183D, 8K0407183F 8W0404693B
	<b>AU11801</b> SALINCAK VE DENGE KOLU BURCU ARKA ÜST	Şasi (Ön / Arka) : ARKA Yön : Üst Ağırlık : 0,250 kg / 0.551 lb	8W0505323F*, 8W0505324F*
	<b>AU12049</b> VİRAJ DEMİR LASTİĞİ	Şasi (Ön / Arka) : ÖN Ağırlık : 0,060 kg / 0.132 lb	8K0411327B

\* Bu sayfada ve katalogdaki tüm araçların adları, markaları, modelleri, sembolleri, logoları, orjinal numaraları (oe) ve diğer üçüncü parti numaraları sadece referans amaçlı kullanılmaktadır.

**A4 8W2, B9 2015 -**









Resim	Ürün Kodu ve Açıklaması	Detay	OEM
	<b>AU12049K</b> VİRAJ DEMİR LASTİĞİ	Şasi (Ön / Arka) : ÖN Ağırlık : 0,120 kg / 0.265 lb	8K0411327B
	<b>AU12025</b> AMORTİSÖR TAKOZU WITHOUT AWD	Ağırlık : 0.522 kg / 1.151 lb Not : WITHOUT AWD	8W0513353
	<b>AU12039</b> SÜSPANSİYON TAKOZU ÖN	Şasi (Ön / Arka) : ÖN Ağırlık : 0,075 kg / 0.165 lb	8K0412131E
	<b>AU12040</b> SÜSPANSİYON TAKOZU ÖN	Şasi (Ön / Arka) : ÖN Ağırlık : 0,075 kg / 0.165 lb	8K0412131F

**A4 ALLROAD 8KH, B8 2009 - 2016**

Resim	Ürün Kodu ve Açıklaması	Detay	OEM
	<b>AU2001</b> ROTBAŞI SAĞ	Ağırlık : 0,801 kg / 1.766 lb Uzunluk : 206 mm / 8.11 inch Gövde Diş Çapı : M16X1,5 Aşık Diş Çapı : M12X1,5 Aşık Konik Çapı : Ø14,6	8K0422818A, 8K0422818B
	<b>AU2002</b> ROTBAŞI SOL	Ağırlık : 0,801 kg / 1.766 lb Uzunluk : 206 mm / 8.11 inch Gövde Diş Çapı : M16X1,5 Aşık Diş Çapı : M12X1,5 Aşık Konik Çapı : Ø14,6	8K0422817A, 8K0422817B
	<b>AU3007</b> ROTMİLİ	Ağırlık : 0,484 kg / 1.067 lb Uzunluk : 225 mm / 8.86 inch Gövde Diş Çapı : M16X1,5 Aşık Diş Çapı : M16X1,5	8J0423810
	<b>AU20013007</b> ROT TAKIMI ÖN AKS SAĞ	Ağırlık : 1,29 kg / 2.844 lb Rotbaşı : AU2001 Rotmili : AU3007	
	<b>AU20023007</b> ROT TAKIMI ÖN AKS SOL	Ağırlık : 1,29 kg / 2.844 lb Rotbaşı : AU2002 Rotmili : AU3007	
	<b>AU4023</b> Z ROT SOL VE SAĞ PLASTİK RB2947	Ağırlık : 0,117 kg / 0.258 lb Malzeme Türü : Plastik Uzunluk : 62 mm / 2.44 inch	8K0505465E, 8K0505465G

\* Bu sayfada ve katalogdaki tüm araçların adları, markaları, modelleri, sembolleri, logoları, orjinal numaraları (oe) ve diğer üçüncü parti numaraları sadece referans amaçlı kullanılmaktadır.

**A4 ALLROAD**
**8KH, B8**
**2009 - 2016**





Resim	Ürün Kodu ve Açıklaması	Detay	OEM
	<b>AU4026</b> Z ROT ÖN DENGE ROTU 170 RB2944	Ağırlık : 0,185 kg / 0.408 lb Malzeme Türü : Denge Rotu Uzunluk : 170 mm / 6.69 inch	8K0411317C, 8K0411317D 8K0411317E
	<b>AU5053</b> SALINCAK ÖN SAĞ	Malzeme Türü : Alüminyum	8K0407694S, 8K0407694T
	<b>AU5054</b> SALINCAK ÖN SOL	Malzeme Türü : Alüminyum	8K0407693Q, 8K0407693T
	<b>AU5062</b> SALINCAK ÖN ALT SAĞ	Ağırlık : 1,3 kg / 2.866 lb Malzeme Türü : Alüminyum	8K0407152B, 8K0407152C 8K0407152D, 8K0407152E
	<b>AU5063</b> SALINCAK ÖN ALT SOL	Ağırlık : 1,3 kg / 2.866 lb Malzeme Türü : Alüminyum	8K0407151D
	<b>AU11044</b> SALINCAK VE DENGE KOLU BURCU ALT ORTA SOL VE SAĞ	Yön : Alt Orta Sol Ve Sağ Ağırlık : 0,1 kg / 0.220 lb	4E0407183B
	<b>AU11054</b> SALINCAK VE DENGE KOLU BURCU SOL VE SAĞ	Yön : Sol Ve Sağ Ağırlık : 0,172 kg / 0.379 lb Not : SALINCAK BURCU	8K0407151B*, 8K0407151B 8K0407152B*
	<b>AU11055</b> SALINCAK VE DENGE KOLU BURCU ALT SOL VE SAĞ	Yön : Alt Sol Ve Sağ Ağırlık : 0,29 kg / 0.639 lb Not : SALINCAK BURCU	8K0407183A, 8K0407183B
	<b>AU11025</b> Z-ROT BURCU ARKA SOL VE SAĞ	Şasi (Ön / Arka) : ARKA Yön : Sol Ve Sağ Ağırlık : 0.032 kg / 0.071 lb Uzunluk : AU4023 mm / 0.00 inch	8K0505465E*, 8K0505465G*

**A5**
**8T3**
**2007 - 2017**

Resim	Ürün Kodu ve Açıklaması	Detay	OEM
	<b>AU1016</b> ROTİL ÖN ALT SAĞ - SOL Ø13,8 RB2411	Ağırlık : 0,5 kg / 1.102 lb Konik Ölçüsü : Ø13,8 Aşık Dış Çapı : M12X1,5 Rotil Gövde Çapı : Ø42	8K0407689E, 8K0407689F 8K0407689G







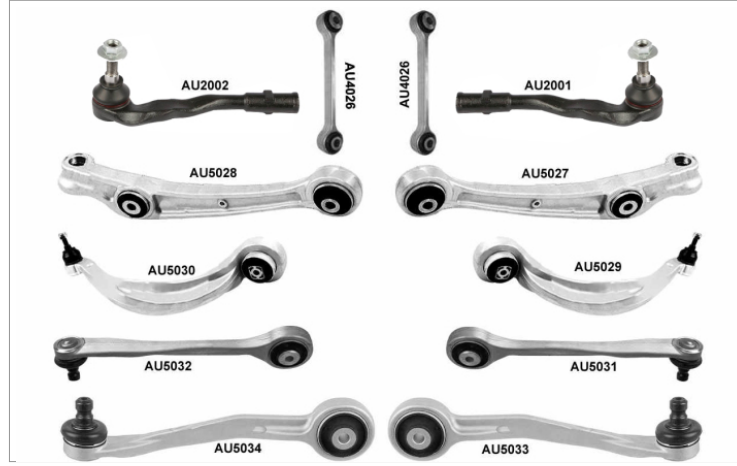



\* Bu sayfada ve katalogdaki tüm araçların adları, markaları, modelleri, sembolleri, logoları, orijinal numaraları (oe) ve diğer üçüncü parti numaraları sadece referans amaçlı kullanılmaktadır.

**A5** **8T3** **2007 - 2017**

Resim	Ürün Kodu ve Açıklaması	Detay	OEM
	<b>AU1019</b> ROTİL ÖN ALT SAĞ - SOL Ø17	Ağırlık : 0,505 kg / 1.113 lb Konik Ölçüsü : Ø17 Aşık Diş Çapı : M14X1,5 Rotil Gövde Çapı : Ø42	4G0407689A, 4G0407689C 8W0407689B
	<b>AU2001</b> ROTBAŞI SAĞ	Ağırlık : 0,801 kg / 1.766 lb Uzunluk : 206 mm / 8.11 inch Gövde Diş Çapı : M16X1,5 Aşık Diş Çapı : M12X1,5 Aşık Konik Çapı : Ø14,6	8K0422818A, 8K0422818B
	<b>AU2002</b> ROTBAŞI SOL	Ağırlık : 0,801 kg / 1.766 lb Uzunluk : 206 mm / 8.11 inch Gövde Diş Çapı : M16X1,5 Aşık Diş Çapı : M12X1,5 Aşık Konik Çapı : Ø14,6	8K0422817A, 8K0422817B
	<b>AU3007</b> ROTMİLİ	Ağırlık : 0,484 kg / 1.067 lb Uzunluk : 225 mm / 8.86 inch Gövde Diş Çapı : M16X1,5 Aşık Diş Çapı : M16X1,5	8J0423810











**AU8005 / Süspansiyon Kit Ön**
**A5**
**8T3**
**2007 - 2017**

**Kit Parçaları**

Resim	Ürün Kodu / Adı	OEM	OEM	Ürün Kodu / Adı	Resim
	<b>AU2001</b> Rotbaşı Sağ	8K0422818A, 8K0422818B	8K0422817A, 8K0422817B	<b>AU2002</b> Rotbaşı Sol	
	<b>AU4026</b> Z Rot Ön Denge Rotu 170 Rb2944	8K0411317C, 8K0411317D 8K0411317E	8K0411317C, 8K0411317D 8K0411317E	<b>AU4026</b> Z Rot Ön Denge Rotu 170 Rb2944	
	<b>AU5027</b> Salıncak Ön Alt Sağ	8K0407152B, 8K0407152C 8K0407152D	8K0407151B	<b>AU5028</b> Salıncak Ön Alt Sol	
	<b>AU5029</b> Salıncak Ön Alt Sağ	8K0407694F, 8K0407694N	8K0407693F, 8K0407693N	<b>AU5030</b> Salıncak Ön Alt Sol	
	<b>AU5031</b> Salıncak Ön Üst Sağ	8K0407506A	8K0407505A	<b>AU5032</b> Salıncak Ön Üst Sol	
	<b>AU5033</b> Salıncak Ön Üst Sağ	8K0407510A	8K0407509, 8K0407509A	<b>AU5034</b> Salıncak Ön Üst Sol	

A5	8T3	2007 - 2017	
Resim	Ürün Kodu ve Açıklaması	Detay	OEM
	<b>AU20013007</b> ROT TAKIMI ÖN AKS SAĞ	Ağırlık : 1,29 kg / 2.844 lb Rotbaşı : AU2001 Rotmili : AU3007	
	<b>AU20023007</b> ROT TAKIMI ÖN AKS SOL	Ağırlık : 1,29 kg / 2.844 lb Rotbaşı : AU2002 Rotmili : AU3007	
	<b>AU4023</b> Z ROT SOL VE SAĞ PLASTİK RB2947	Ağırlık : 0,117 kg / 0.258 lb Malzeme Türü : Plastik Uzunluk : 62 mm / 2.44 inch	8K0505465E, 8K0505465G
	<b>AU4024</b> Z ROT ARKA SAĞ	Ağırlık : 0,508 kg / 1.120 lb Uzunluk : 282,5 mm / 11.12 inch	8K0501530K, 8K0501530N
	<b>AU4025</b> Z ROT ARKA SOL	Ağırlık : 0,508 kg / 1.120 lb Uzunluk : 282,5 mm / 11.12 inch	8K0501529K, 8K0501529N
	<b>AU4026</b> Z ROT ÖN DENGE ROTU 170 RB2944	Ağırlık : 0,185 kg / 0.408 lb Malzeme Türü : Denge Rotu Uzunluk : 170 mm / 6.69 inch	8K0411317C, 8K0411317D 8K0411317E
	<b>AU4030</b> Z ROT ÖN ALÜMİNYUM L=110	Ağırlık : 0,151 kg / 0.333 lb Malzeme Türü : Alüminyum Uzunluk : 110 mm / 4.33 inch	8K0411317B
	<b>AU5027</b> SALINCAK ÖN ALT SAĞ	Malzeme Türü : Alüminyum	8K0407152B, 8K0407152C 8K0407152D
	<b>AU5028</b> SALINCAK ÖN ALT SOL	Malzeme Türü : Alüminyum	8K0407151B
	<b>AU5029</b> SALINCAK ÖN ALT SAĞ	Malzeme Türü : Alüminyum	8K0407694F, 8K0407694N
	<b>AU5030</b> SALINCAK ÖN ALT SOL	Malzeme Türü : Alüminyum	8K0407693F, 8K0407693N

\* Bu sayfada ve katalogdaki tüm araçların adları, markaları, modelleri, sembolleri, logoları, orjinal numaraları (oe) ve diğer üçüncü parti numaraları sadece referans amaçlı kullanılmaktadır.

**A5** **8T3** **2007 - 2017**

Resim	Ürün Kodu ve Açıklaması	Detay	OEM
	<b>AU5031</b> SALINCAK ÖN ÜST SAĞ	Malzeme Türü : Alüminyum	8K0407506A
	<b>AU5032</b> SALINCAK ÖN ÜST SOL	Malzeme Türü : Alüminyum	8K0407505A
	<b>AU5033</b> SALINCAK ÖN ÜST SAĞ	Malzeme Türü : Alüminyum	8K0407510A
	<b>AU5034</b> SALINCAK ÖN ÜST SOL	Malzeme Türü : Alüminyum	8K0407509, 8K0407509A
	<b>AU5049</b> SALINCAK ÖN ALT SAĞ	Malzeme Türü : Alüminyum	8K0407152F, 8K0407152G
	<b>AU5050</b> SALINCAK ÖN ALT SOL	Malzeme Türü : Alüminyum	8K0407151F, 8K0407151G
	<b>AU5053</b> SALINCAK ÖN SAĞ	Malzeme Türü : Alüminyum	8K0407694S, 8K0407694T
	<b>AU5054</b> SALINCAK ÖN SOL	Malzeme Türü : Alüminyum	8K0407693Q, 8K0407693T
	<b>AU5062</b> SALINCAK ÖN ALT SAĞ	Ağırlık : 1,3 kg / 2.866 lb Malzeme Türü : Alüminyum	8K0407152B, 8K0407152C 8K0407152D, 8K0407152E
	<b>AU5063</b> SALINCAK ÖN ALT SOL	Ağırlık : 1,3 kg / 2.866 lb Malzeme Türü : Alüminyum	8K0407151D
	<b>AU5073</b> SALINCAK ÖN ALT SAĞ	Ağırlık : 2,330 kg / 5.137 lb Malzeme Türü : Alüminyum	8K0407694AD, 8K0407694Q 8K0407694S, 8R0407694B 8R0407694D, 9A740769403

\* Bu sayfada ve katalogdaki tüm araçların adları, markaları, modelleri, sembolleri, logoları, orjinal numaraları (oe) ve diğer üçüncü parti numaraları sadece referans amaçlı kullanılmaktadır.



A5	8T3	2007 - 2017	
Resim	Ürün Kodu ve Açıklaması	Detay	OEM
	<b>AU5074</b> SALINCAK ÖN ALT SOL	Ağırlık : 2,330 kg / 5.137 lb Malzeme Türü : Alüminyum	8K0407693AD, 8K0407693Q 8K0407693S, 8R0407693B 8R0407693D, 9A740769303
	<b>AU9001</b> SALINCAK ARKA	Ağırlık : 0,546 kg / 1.204 lb Malzeme Türü : Sac Metal	8K0501529L
	<b>AU9002</b> SALINCAK ARKA	Ağırlık : 1,95 kg / 4.299 lb Malzeme Türü : Sac Metal	8E0501529F, 8E0501529G 8E0501529K, 8E0501529L 8E0501529P
	<b>AU11036</b> SALINCAK VE DENGE KOLU BURCU ÖN SOL VE SAĞ	Şasi (Ön / Arka) : ÖN Yön : Sol Ve Sağ Ağırlık : 0,25 kg / 0.551 lb Not : DENGE KOLU BURCU	4H0407515, 8D0407515A 8K0407515, 8R0407515
	<b>AU11043</b> SALINCAK VE DENGE KOLU BURCU ÖN ALT ORTA SOL VE SAĞ B22137	Şasi (Ön / Arka) : ÖN Yön : Alt Orta Sol Ve Sağ Ağırlık : 0,1 kg / 0.220 lb	4E0407181B
	<b>AU11044</b> SALINCAK VE DENGE KOLU BURCU ALT ORTA SOL VE SAĞ	Yön : Alt Orta Sol Ve Sağ Ağırlık : 0,1 kg / 0.220 lb	4E0407183B
	<b>AU11045</b> SALINCAK VE DENGE KOLU BURCU ÜST SOL VE SAĞ	Yön : Üst Sol Ve Sağ Ağırlık : 0,1 kg / 0.220 lb	4E0407515D, 8D0407515B 8K0407515
	<b>AU11054</b> SALINCAK VE DENGE KOLU BURCU SOL VE SAĞ	Yön : Sol Ve Sağ Ağırlık : 0,172 kg / 0.379 lb Not : SALINCAK BURCU	8K0407151B*, 8K0407151B 8K0407152B*
	<b>AU11055</b> SALINCAK VE DENGE KOLU BURCU ALT SOL VE SAĞ	Yön : Alt Sol Ve Sağ Ağırlık : 0,29 kg / 0.639 lb Not : SALINCAK BURCU	8K0407183A, 8K0407183B
	<b>AU11090</b> SALINCAK VE DENGE KOLU BURCU ÖN ALT	Şasi (Ön / Arka) : ÖN Yön : Alt Ağırlık : 0,595 kg / 1.312 lb Not : HYDRAULIC	8K0407183D, 8K0407183F 8W0404693B
	<b>AU11025</b> Z-ROT BURCU ARKA SOL VE SAĞ	Şasi (Ön / Arka) : ARKA Yön : Sol Ve Sağ Ağırlık : 0.032 kg / 0.071 lb Uzunluk : AU4023 mm / 0.00 inch	8K0505465E*, 8K0505465G*

\* Bu sayfada ve katalogdaki tüm araçların adları, markaları, modelleri, sembolleri, logoları, orijinal numaraları (oe) ve diğer üçüncü parti numaraları sadece referans amaçlı kullanılmaktadır.

**A5**
**8T3**
**2007 - 2017**

Resim	Ürün Kodu ve Açıklaması	Detay	OEM
	<b>AU11053</b> Z-ROT BURCU SOL VE SAĞ	Yön : Sol Ve Sağ Ağırlık : 0,082 kg / 0.181 lb Uzunluk : AU9001 mm / 0.00 inch Aşık Diş Çapı : AU4024 Not : AU4025	8K0501529N*, 8K0501530N*
	<b>AU12049</b> VİRAJ DEMİR LASTİĞİ	Şasi (Ön / Arka) : ÖN Ağırlık : 0,060 kg / 0.132 lb	8K0411327B
	<b>AU12049K</b> VİRAJ DEMİR LASTİĞİ	Şasi (Ön / Arka) : ÖN Ağırlık : 0,120 kg / 0.265 lb	8K0411327B
	<b>AU12050</b> VİRAJ DEMİR LASTİĞİ	Şasi (Ön / Arka) : ÖN Ağırlık : 0,059 kg / 0.130 lb	8K0411327A
	<b>AU12050K</b> VİRAJ DEMİR LASTİĞİ	Şasi (Ön / Arka) : ÖN Ağırlık : 0,118 kg / 0.260 lb	8K0411327A
	<b>AU12032</b> MOTOR TAKOZU ÖN MERKEZ	Şasi (Ön / Arka) : ÖN Yön : Merkez Ağırlık : 0,675 kg / 1.488 lb	8K0399151AQ, 8K0399151BD
	<b>AU12048</b> ŞANZIMAN TAKOZU ARKA ORTA	Şasi (Ön / Arka) : ARKA Yön : Orta Ağırlık : 0,641 kg / 1.413 lb	8K0399151BF, 8K0399151CD 8K0399151DB
	<b>AU12038</b> SÜSPANSİYON TAKOZU ARKA	Şasi (Ön / Arka) : ARKA Ağırlık : 0,095 kg / 0.209 lb	8K0512131B, 8T0513028AB 8T0513028R, 8T0513029 8T0513029A
	<b>AU12039</b> SÜSPANSİYON TAKOZU ÖN	Şasi (Ön / Arka) : ÖN Ağırlık : 0,075 kg / 0.165 lb	8K0412131E
	<b>AU12040</b> SÜSPANSİYON TAKOZU ÖN	Şasi (Ön / Arka) : ÖN Ağırlık : 0,075 kg / 0.165 lb	8K0412131F
	<b>F114009</b> AKS KÖRÜĞÜ +KELEPÇE+YAĞ. DIŞ	Ağırlık : 0.207 kg / 0.456 lb	46307716

\* Bu sayfada ve katalogdaki tüm araçların adları, markaları, modelleri, sembolleri, logoları, orjinal numaraları (oe) ve diğer üçüncü parti numaraları sadece referans amaçlı kullanılmaktadır.

**A5 8T3 2007 - 2017**











Resim	Ürün Kodu ve Açıklaması	Detay	OEM
	<b>OP14017</b> AKS KÖRÜĞÜ +KELEPÇE+YAĞ. DIŞ	Ağırlık : 0.17 kg / 0.375 lb	1603277

**A5 F5A, F53, F57 2016 -**

Resim	Ürün Kodu ve Açıklaması	Detay	OEM
	<b>AU1019</b> ROTİL ÖN ALT SAĞ - SOL Ø17	Ağırlık : 0,505 kg / 1.113 lb Konik Ölçüsü : Ø17 Aşık Diş Çapı : M14X1,5 Rotil Gövde Çapı : Ø42	4G0407689A, 4G0407689C 8W0407689B
	<b>AU2027</b> ROTBAŞI ÖN SAĞ	Ağırlık : 0,812 kg / 1.790 lb Uzunluk : 216 mm / 8.50 inch Gövde Diş Çapı : M16X1,5 Aşık Diş Çapı : M14X1,5	8W0423812B, 8W0423812C
	<b>AU2028</b> ROTBAŞI ÖN SOL	Ağırlık : 0,812 kg / 1.790 lb Uzunluk : 216 mm / 8.50 inch Gövde Diş Çapı : M16X1,5 Aşık Diş Çapı : M14X1,5	8W0423811B, 8W0423811C
	<b>AU3014</b> ROTMİLİ ÖN SAĞ - SOL	Ağırlık : 0,533 kg / 1.175 lb	8W0423810A
	<b>AU4035</b> Z ROT SOL VE SAĞ	Ağırlık : 0,281 kg / 0.619 lb Uzunluk : 174,5 mm / 6.87 inch	4N0505465F, 8W0505465B
	<b>AU5064</b> SALINCAK ÖN ALT SAĞ	Ağırlık : 1,280 kg / 2.822 lb Malzeme Türü : Alüminyum	8W0407152A
	<b>AU5065</b> SALINCAK ÖN ALT SOL	Ağırlık : 1,280 kg / 2.822 lb Malzeme Türü : Alüminyum	8W0407151A
	<b>AU5066</b> SALINCAK ÖN SAĞ ÜST	Ağırlık : 0,450 kg / 0.992 lb Malzeme Türü : Alüminyum	8W0407509A, 8W0407509B 8W0407509E, 8W0407510 8W0407510A, 8W0407510B 8W0407510E, 8WD407509
	<b>AU5067</b> SALINCAK ÖN SOL ÜST	Ağırlık : 0,450 kg / 0.992 lb Malzeme Türü : Alüminyum	











\* Bu sayfada ve katalogdaki tüm araçların adları, markaları, modelleri, sembolleri, logoları, orjinal numaraları (oe) ve diğer üçüncü parti numaraları sadece referans amaçlı kullanılmaktadır.

**A5 F5A, F53, F57 2016 -**

Resim	Ürün Kodu ve Açıklaması	Detay	OEM
	<b>AU5068</b> SALINCAK ÖN SAĞ ÜST	Ağırlık : 0,484 kg / 1.067 lb Malzeme Türü : Alüminyum	8W0407506, 8W0407506A 8W0407506C
	<b>AU5069</b> SALINCAK ÖN SOL ÜST	Ağırlık : 0,484 kg / 1.067 lb Malzeme Türü : Alüminyum	8W0407505, 8W0407505A 8W0407505C
	<b>AU5071</b> SALINCAK ÖN ALT ARKADAN SAĞ	Ağırlık : 2,150 kg / 4.740 lb Malzeme Türü : Alüminyum	8W0407694A, 8W0407694B 8WD407694
	<b>AU5072</b> SALINCAK ÖN ALT ARKADAN SOL	Ağırlık : 2,150 kg / 4.740 lb Malzeme Türü : Alüminyum	8W0407693A, 8W0407693B 8WD407693
	<b>AU9016</b> SALINCAK ÜST SAĞ	Ağırlık : 0,926 kg / 2.041 lb Malzeme Türü : Alüminyum	8W0505324F
	<b>AU9017</b> SALINCAK ÜST SOL	Ağırlık : 0,926 kg / 2.041 lb Malzeme Türü : Alüminyum	8W0505323F
	<b>AU9020</b> SALINCAK ARKA ALT ARKADAN SAĞ	Ağırlık : 0,708 kg / 1.561 lb Malzeme Türü : Sac Metal	4M0505292D, 80A505292
	<b>AU9021</b> SALINCAK ARKA ALT ARKADAN SOL	Ağırlık : 0,708 kg / 1.561 lb Malzeme Türü : Sac Metal	4M0505291D, 80A505291
	<b>AU9025</b> SALINCAK ALT SAĞ	Ağırlık : 0,883 kg / 1.947 lb Malzeme Türü : Sac Metal	8W0501530D
	<b>AU9026</b> SALINCAK ALT SOL	Ağırlık : 0,883 kg / 1.947 lb Malzeme Türü : Sac Metal	8W0501529D
	<b>AU9027</b> SALINCAK ARKA ÜST ARKADAN SAĞ	Ağırlık : 1,416 kg / 3.122 lb Malzeme Türü : Sac Metal	8W0505398C, 8W0505398F

\* Bu sayfada ve katalogdaki tüm araçların adları, markaları, modelleri, sembolleri, logoları, orjinal numaraları (oe) ve diğer üçüncü parti numaraları sadece referans amaçlı kullanılmaktadır.

**A5**
**F5A, F53, F57**
**2016 -**

Resim	Ürün Kodu ve Açıklaması	Detay	OEM
	<b>AU9028</b> SALINCAK ARKA ÜST ARKADAN SOL	Ağırlık : 1,416 kg / 3.122 lb Malzeme Türü : Sac Metal	8W0505397C, 8W0505397F
	<b>AU11043</b> SALINCAK VE DENGE KOLU BURCU ÖN ALT ORTA SOL VE SAĞ B22137	Şasi (Ön / Arka) : ÖN Yön : Alt Orta Sol Ve Sağ Ağırlık : 0,1 kg / 0.220 lb	4E0407181B
	<b>AU11054</b> SALINCAK VE DENGE KOLU BURCU SOL VE SAĞ	Yön : Sol Ve Sağ Ağırlık : 0,172 kg / 0.379 lb Not : SALINCAK BURCU	8K0407151B*, 8K0407151B 8K0407152B*
	<b>AU11072</b> SALINCAK VE DENGE KOLU BURCU ARKA ALT	Şasi (Ön / Arka) : ARKA Yön : Alt Ağırlık : 0,250 kg / 0.551 lb	4M0501529L*, 4M0501529N* 4M0501530N*
	<b>AU11077</b> SALINCAK VE DENGE KOLU BURCU ARKA ALT	Şasi (Ön / Arka) : ARKA Yön : Alt Ağırlık : 0,125 kg / 0.276 lb	8W0501529D*, 8W0501530D*
	<b>AU11078</b> SALINCAK VE DENGE KOLU BURCU ARKA ARKA ÜST ARKADAN	Şasi (Ön / Arka) : ARKA Yön : Arka Üst Arkadan Ağırlık : 0,115 kg / 0.254 lb	8W0505397C*, 8W0505397F* 8W0505398C*, 8W0505398F*
	<b>AU11081</b> SALINCAK VE DENGE KOLU BURCU ARKA DIŞ ÜST	Şasi (Ön / Arka) : ARKA Yön : Dış Üst Ağırlık : 0,095 kg / 0.209 lb	8W0505323F*, 8W0505324F*
	<b>AU11082</b> SALINCAK VE DENGE KOLU BURCU ARKA ÜST MERKEZ	Şasi (Ön / Arka) : ARKA Yön : Üst Merkez Ağırlık : 0,050 kg / 0.110 lb	8W0505323F*, 8W0505324F*
	<b>AU11083</b> SALINCAK VE DENGE KOLU BURCU ARKA İÇ ÜST	Şasi (Ön / Arka) : ARKA Yön : İç Üst Ağırlık : 0,105 kg / 0.231 lb	8W0505323F*, 8W0505324F*
	<b>AU11089</b> SALINCAK VE DENGE KOLU BURCU ÖN ÜST	Şasi (Ön / Arka) : ÖN Yön : Üst Ağırlık : 0.11 kg / 0.243 lb	8W0407505C, 8W0407506C 8W0407509B, 8W0407515
	<b>AU11090</b> SALINCAK VE DENGE KOLU BURCU ÖN ALT	Şasi (Ön / Arka) : ÖN Yön : Alt Ağırlık : 0,595 kg / 1.312 lb Not : HYDRAULIC	8K0407183D, 8K0407183F 8W0404693B

\* Bu sayfada ve katalogdaki tüm araçların adları, markaları, modelleri, sembolleri, logoları, orjinal numaraları (oe) ve diğer üçüncü parti numaraları sadece referans amaçlı kullanılmaktadır.

**A5 F5A, F53, F57 2016 -**





Resim	Ürün Kodu ve Açıklaması	Detay	OEM
	<b>AU11801</b> SALINCAK VE DENG KOLU BURCU ARKA ÜST	Şasi (Ön / Arka) : ARKA Yön : Üst Ağırlık : 0,250 kg / 0.551 lb	8W0505323F*, 8W0505324F*
	<b>AU12039</b> SÜSPANSİYON TAKOZU ÖN	Şasi (Ön / Arka) : ÖN Ağırlık : 0,075 kg / 0.165 lb	8K0412131E
	<b>AU12040</b> SÜSPANSİYON TAKOZU ÖN	Şasi (Ön / Arka) : ÖN Ağırlık : 0,075 kg / 0.165 lb	8K0412131F

**A6 4A, 4C 1994 - 1997**

Resim	Ürün Kodu ve Açıklaması	Detay	OEM
	<b>AU2314</b> ROTBAŞI SAĞ RB2314	Ağırlık : 0,302 kg / 0.666 lb Uzunluk : 73 mm / 2.87 inch Gövde Diş Çapı : M16X1,5 Aşık Diş Çapı : M12X1,5 Aşık Konik Çapı : Ø12,6	443419812B, 443419812D
	<b>AU2315</b> ROTBAŞI SOL RB2315	Ağırlık : 0,307 kg / 0.677 lb Uzunluk : 73 mm / 2.87 inch Gövde Diş Çapı : M16X1,5 Aşık Diş Çapı : M12X1,5 Aşık Konik Çapı : Ø12,6	443419811B, 443419811D
	<b>AU4002</b> Z ROT ARKA SAĞ - SOL METAL RB2919	Ağırlık : 0,266 kg / 0.586 lb Malzeme Türü : Metal Uzunluk : 122 mm / 4.80 inch Aşık Diş Çapı : M10X1,5	4A0505389
	<b>AU5005</b> SALINCAK ÖN SAĞ RB2614	Malzeme Türü : Dövme Çelik	4A0407152
	<b>AU5006</b> SALINCAK ÖN SOL RB2613	Malzeme Türü : Dövme Çelik	4A0407151
	<b>AU11008</b> SALINCAK VE DENG KOLU BURCU ARKA SOL VE SAĞ	Şasi (Ön / Arka) : ARKA Yön : Sol Ve Sağ Ağırlık : 0,269 kg / 0.593 lb	4A0511247
	<b>AU11011</b> SALINCAK VE DENG KOLU BURCU ÖN SOL VE SAĞ B22122	Şasi (Ön / Arka) : ÖN Yön : Sol Ve Sağ Ağırlık : 0,322 kg / 0.710 lb	4A0407183C, 4A0407183D

\* Bu sayfada ve katalogdaki tüm araçların adları, markaları, modelleri, sembolleri, logoları, orjinal numaraları (oe) ve diğer üçüncü parti numaraları sadece referans amaçlı kullanılmaktadır.











**A6 4A, 4C 1994 - 1997**

Resim	Ürün Kodu ve Açıklaması	Detay	OEM
	<b>AU11013</b> SALINCAK VE DENGE KOLU BURCU ÖN ORTA SOL VE SAĞ B22121	Şasi (Ön / Arka) : ÖN Yön : Orta Sol Ve Sağ Ağırlık : 0,095 kg / 0.209 lb	4A0407181, 4A0407181A
	<b>AU11013K</b> SALINCAK VE DENGE KOLU BURCU ÖN ORTA SOL VE SAĞ	Şasi (Ön / Arka) : ÖN Yön : Orta Sol Ve Sağ Ağırlık : 0,095 kg / 0.209 lb Not : 2 Pieces	4A0407181, 4A0407181A
	<b>AU12003</b> VİRAJ DEMİR LASTİĞİ SOL VE SAĞ	Şasi (Ön / Arka) : ÖN Yön : Sol Ve Sağ Ağırlık : 0,130 kg / 0.287 lb	4A0411327A
	<b>VW12022</b> AMORTİSÖR TAKOZU SOL VE SAĞ AMORTİSÖR TAKOZU	Yön : Sol Ve Sağ Ağırlık : 0.44 kg / 0.970 lb Not : AMORTİSÖR TAKOZU	4D0412377F
	<b>AU12017</b> ŞANZİMAN TAKOZU SOL VE SAĞ ŞANZİMAN TAKOZU	Yön : Sol Ve Sağ Ağırlık : 0,535 kg / 1.179 lb Not : ŞANZİMAN TAKOZU	4A0399151D, 4A0399151K
	<b>OP14003</b> AKS KÖRÜĞÜ +KELEPÇE+YAĞ. AKS KÖRÜĞÜ DİŞ	Ağırlık : 0.2 kg / 0.441 lb	1603180
	<b>RN14006</b> AKS KÖRÜĞÜ +KELEPÇE+YAĞ. DİŞ	Ağırlık : 0.2 kg / 0.441 lb	1603180, 1603204 16410170470106*, 16500170470106* 1H0498203, 271648 271649, 321498203A 431498203C, 443498203D
	<b>VW14001</b> AKS KÖRÜĞÜ +KELEPÇE+YAĞ. DİŞ	Ağırlık : 0.14 kg / 0.309 lb	441 407 203A, 441407203A

**A6 4A, C8 2018 -**











Resim	Ürün Kodu ve Açıklaması	Detay	OEM
	<b>AU1023</b> ROTİL ALT	Ağırlık : 0,505 kg / 1.113 lb	80A407689B
	<b>AU2027</b> ROTBAŞI ÖN SAĞ	Ağırlık : 0,812 kg / 1.790 lb Uzunluk : 216 mm / 8.50 inch Gövde Diş Çapı : M16X1,5 Aşık Diş Çapı : M14X1,5	8W0423812B, 8W0423812C

\* Bu sayfada ve katalogdaki tüm araçların adları, markaları, modelleri, sembolleri, logoları, orijinal numaraları (oe) ve diğer üçüncü parti numaraları sadece referans amaçlı kullanılmaktadır.











A6	4A, C8	2018 -	
Resim	Ürün Kodu ve Açıklaması	Detay	OEM
	<b>AU2028</b> ROTBAŞI ÖN SOL	Ağırlık : 0,812 kg / 1.790 lb Uzunluk : 216 mm / 8.50 inch Gövde Diş Çapı : M16X1,5 Aşık Diş Çapı : M14X1,5	8W0423811B, 8W0423811C
	<b>AU3013</b> ROTMİLİ ÖN SAĞ - SOL	Ağırlık : 0,565 kg / 1.246 lb Uzunluk : 237 mm / 9.33 inch Gövde Diş Çapı : M16X1,5 Aşık Diş Çapı : M16X1,5	4M0423810C
	<b>AU4031</b> Z ROT ÖN ALÜMİNYUM L=170	Ağırlık : 0,201 kg / 0.443 lb Malzeme Türü : Alüminyum Uzunluk : 170 mm / 6.69 inch	4G0411317A, 4G0411317C 4M0411317
	<b>AU4033</b> Z ROT ARKA SAĞ - SOL ALÜMİNYUM	Ağırlık : 0,320 kg / 0.705 lb Malzeme Türü : Alüminyum Uzunluk : 174 mm / 6.85 inch	4M0505465D
	<b>AU4035</b> Z ROT SOL VE SAĞ	Ağırlık : 0,281 kg / 0.619 lb Uzunluk : 174,5 mm / 6.87 inch	4N0505465F, 8W0505465B
	<b>AU5075</b> SALINCAK ÜST ARKA TARAF SAĞ	Ağırlık : 0.55 kg / 1.213 lb Malzeme Türü : Alüminyum	4M0407510B, 4M0407510C 80A407510A
	<b>AU5076</b> SALINCAK ÜST ARKA TARAF SOL	Ağırlık : 0.55 kg / 1.213 lb Malzeme Türü : Alüminyum	4M0407509B, 4M0407509C 80A407509A
	<b>AU5077</b> SALINCAK ÜST ÖN TARAF SAĞ	Ağırlık : 0.56 kg / 1.235 lb Malzeme Türü : Alüminyum	4M0407506B, 4M0407506C 80A407506A
	<b>AU5078</b> SALINCAK ÜST ÖN TARAF SOL	Ağırlık : 0.56 kg / 1.235 lb Malzeme Türü : Alüminyum	4M0407505B, 4M0407505C 80A407505A
	<b>AU5083</b> SALINCAK ÖN ALT ÖNDEN SAĞ	Ağırlık : 1,430 kg / 3.153 lb Malzeme Türü : Alüminyum	4K0407152, 4K0407152A 4K0407152B, 4K0407152C 80A407152A
	<b>AU5084</b> SALINCAK ÖN ALT ÖNDEN SOL	Ağırlık : 1,430 kg / 3.153 lb Malzeme Türü : Alüminyum	4K0407151, 4K0407151A 4K0407151B, 4K0407151C 80A407151A

\* Bu sayfada ve katalogdaki tüm araçların adları, markaları, modelleri, sembolleri, logoları, orjinal numaraları (oe) ve diğer üçüncü parti numaraları sadece referans amaçlı kullanılmaktadır.



A6	4A, C8	2018 -	
Resim	Ürün Kodu ve Açıklaması	Detay	OEM
	<b>AU5089</b> SALINCAK VE DENGİ KOLU ÖN ALT ARKADAN SAĞ	Ağırlık : 2,545 kg / 5.611 lb Malzeme Türü : Alüminyum	80A407694B, 80A407694C 80A407694D, 80A407694E 80A407694G
	<b>AU5090</b> SALINCAK VE DENGİ KOLU ÖN ALT ARKADAN SOL	Ağırlık : 2,545 kg / 5.611 lb Malzeme Türü : Alüminyum	80A407693B, 80A407693C 80A407693D, 80A407693E 80A407693G
	<b>AU9018</b> SALINCAK ARKA ARKADAN SAĞ	Ağırlık : 1,150 kg / 2.535 lb Malzeme Türü : Sac Metal	4M0501530N, 80A501530A
	<b>AU9019</b> SALINCAK ARKA ARKADAN SOL	Ağırlık : 1,150 kg / 2.535 lb Malzeme Türü : Sac Metal	4M0501529N, 80A501529A
	<b>AU9022</b> SALINCAK ARKA ALT ARKADAN	Ağırlık : 1,322 kg / 2.915 lb Malzeme Türü : Alüminyum	4M0501529L
	<b>AU9029</b> SALINCAK ARKA ALT ARKADAN	Ağırlık : 0,811 kg / 1.788 lb Malzeme Türü : Alüminyum	4M0505323G
	<b>AU9031</b> SALINCAK VE DENGİ KOLU ARKA ÜST SAĞ ALÜMİNYUM	Ağırlık : 1,545 kg / 3.406 lb Malzeme Türü : Alüminyum	4K0505398A, 4M0505398L
	<b>AU9032</b> SALINCAK VE DENGİ KOLU ARKA ÜST SOL ALÜMİNYUM	Ağırlık : 1,545 kg / 3.406 lb Malzeme Türü : Alüminyum	4K0505397A, 4M0505397L
	<b>AU9033</b> SALINCAK ARKA ÖNDEN SAĞ ALÜMİNYUM	Ağırlık : 0,945 kg / 2.083 lb Malzeme Türü : Alüminyum	4M0505292F
	<b>AU9034</b> SALINCAK VE DENGİ KOLU ARKA ÖNDEN SOL ALÜMİNYUM	Ağırlık : 0,945 kg / 2.083 lb Malzeme Türü : Alüminyum	4M0505291F
	<b>AU9035</b> SALINCAK VE DENGİ KOLU ARKA ÜST SAĞ SAC LEVHA	Ağırlık : 1,245 kg / 2.745 lb Malzeme Türü : Sac Metal	4N0505398A, 80A505398A

\* Bu sayfada ve katalogdaki tüm araçların adları, markaları, modelleri, sembolleri, logoları, orjinal numaraları (oe) ve diğer üçüncü parti numaraları sadece referans amaçlı kullanılmaktadır.





A6	4A, C8	2018 -	
Resim	Ürün Kodu ve Açıklaması	Detay	OEM
	<b>AU9036</b> SALINCAK VE DENG KOLU ARKA ÜST SOL SAC LEVHA	Ağırlık : 1,245 kg / 2.745 lb Malzeme Türü : Sac Metal	4N0505397A, 80A505397A
	<b>AU11043</b> SALINCAK VE DENG KOLU BURCU ÖN ALT ORTA SOL VE SAĞ B22137	Şasi (Ön / Arka) : ÖN Yön : Alt Orta Sol Ve Sağ Ağırlık : 0,1 kg / 0.220 lb	4E0407181B
	<b>AU11071</b> SALINCAK VE DENG KOLU BURCU ARKA ALT	Şasi (Ön / Arka) : ARKA Yön : Alt Ağırlık : 0,250 kg / 0.551 lb	4M0501529L*, 4M0501529N* 4M0501530N*
	<b>AU11072</b> SALINCAK VE DENG KOLU BURCU ARKA ALT	Şasi (Ön / Arka) : ARKA Yön : Alt Ağırlık : 0,250 kg / 0.551 lb	4M0501529L*, 4M0501529N* 4M0501530N*
	<b>AU11073</b> SALINCAK VE DENG KOLU BURCU ÖN ÜST	Şasi (Ön / Arka) : ÖN Yön : Üst Ağırlık : 0,620 kg / 1.367 lb	4M0407693C, 4M0407693D 4M0407693E, 4M0407694C 4M0407694D, 4M0407694E 95840769300, 95840769400
	<b>AU11075</b> SALINCAK VE DENG KOLU BURCU ÖN ÖN ALT ÖNDEN	Şasi (Ön / Arka) : ÖN Yön : Ön Alt Önden Ağırlık : 0,207 kg / 0.456 lb	4M0407151H*, 4M0407152H* 80A407151A*, 80A407152A*
	<b>AU11078</b> SALINCAK VE DENG KOLU BURCU ARKA ARKA ÜST ARKADAN	Şasi (Ön / Arka) : ARKA Yön : Arka Üst Arkadan Ağırlık : 0,115 kg / 0.254 lb	8W0505397C*, 8W0505397F* 8W0505398C*, 8W0505398F*
	<b>AU11083</b> SALINCAK VE DENG KOLU BURCU ARKA İÇ ÜST	Şasi (Ön / Arka) : ARKA Yön : İç Üst Ağırlık : 0,105 kg / 0.231 lb	8W0505323F*, 8W0505324F*
	<b>AU11092</b> SALINCAK VE DENG KOLU BURCU ÖN ALT ARKADAN	Şasi (Ön / Arka) : ÖN Yön : Alt Arkadan Ağırlık : 0,515 kg / 1.135 lb	80A407693B*, 80A407693C* 80A407693D*, 80A407693E* 80A407693G*, 80A407694B* 80A407694C*, 80A407694D* 80A407694E*, 80A407694G*
	<b>AU11093</b> SALINCAK VE DENG KOLU BURCU ARKA ÖNDEN	Şasi (Ön / Arka) : ARKA Yön : Önden Ağırlık : 0,115 kg / 0.254 lb	4M0505291F*, 4M0505292F*
	<b>AU11094</b> SALINCAK VE DENG KOLU BURCU ARKA ÜST	Şasi (Ön / Arka) : ARKA Yön : Üst Ağırlık : 0,145 kg / 0.320 lb	4N0505397A*, 4N0505398A* 80A505397A*, 80A505398A*

\* Bu sayfada ve katalogdaki tüm araçların adları, markaları, modelleri, sembolleri, logoları, orjinal numaraları (oe) ve diğer üçüncü parti numaraları sadece referans amaçlı kullanılmaktadır.

**A6 4A, C8 2018 -**

Resim	Ürün Kodu ve Açıklaması	Detay	OEM
	<b>AU12039</b> SÜSPANSİYON TAKOZU ÖN	Şasi (Ön / Arka) : ÖN Ağırlık : 0,075 kg / 0.165 lb	8K0412131E
	<b>AU12040</b> SÜSPANSİYON TAKOZU ÖN	Şasi (Ön / Arka) : ÖN Ağırlık : 0,075 kg / 0.165 lb	8K0412131F

**A6 4B, C5 1997 - 2005**

Resim	Ürün Kodu ve Açıklaması	Detay	OEM
	<b>AU2214</b> ROTBAŞI ÖN SAĞ - SOL RB2214	Ağırlık : 0,594 kg / 1.310 lb Uzunluk : 156 mm / 6.14 inch Gövde Diş Çapı : M14X1,5 Aşık Diş Çapı : M8X1,25 Aşık Konik Çapı : Ø17,5	4B0419811B, 4B0419811C 4B0419811E, 4B0419811F 4D0419811A, 4D0419811B 4D0419811G, 4D0419811H 4F0419811E, 4F0498811
	<b>AU2214A</b> ROTBAŞI SAĞ-SOL (KOMPLE DEMİR) RB2225	Ağırlık : 0,597 kg / 1.316 lb Uzunluk : 156 mm / 6.14 inch Gövde Diş Çapı : M14X1,5 Aşık Diş Çapı : M8X1,25 Aşık Konik Çapı : Ø17,4	4B0419811B, 4D0419811A 4D0419811J, 8E0419811B 8E0419811C
	<b>AU2217</b> ROTBAŞI SAĞ-SOL RB2217	Ağırlık : 0,414 kg / 0.913 lb Uzunluk : 155 mm / 6.10 inch Gövde Diş Çapı : M14X1,5 Aşık Diş Çapı : M8X1,25 Aşık Konik Çapı : Ø17,5	4B0419811G, 4D0419811J 4F0419811C, 4F0419811D 4F0498811, 4F0498811A 8E0419811
	<b>AU3002</b> ROTMİLİ SAĞ-SOL 144 MM RB2814	Ağırlık : 0,445 kg / 0.981 lb Uzunluk : 130 mm / 5.12 inch Gövde Diş Çapı : M16X1,5 Aşık Diş Çapı : M14X1,5	4B0422821, 4D0422821 4D0422821A
	<b>AU3011</b> ROTMİLİ SAĞ-SOL 128 RB2831	Ağırlık : 0.46 kg / 1.014 lb Uzunluk : 130 mm / 5.12 inch Gövde Diş Çapı : M16X1,5 Aşık Diş Çapı : M14X1,5	4E0419821A, 4F0419882 8E0419821, 8E0422801B 8E0422821, 8E0422821C 8E0422822

## AU8001 / Süspansiyon Kit Ön

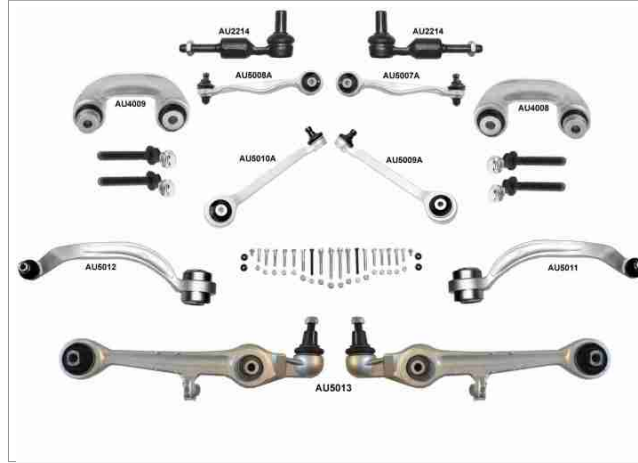
**A6**
**4B, C5**
**1997 - 2005**

**OEM**

8D0498998, 8D0498998-S1

### Kit Parçaları

Resim	Ürün Kodu / Adı	OEM	OEM	Ürün Kodu / Adı	Resim
	<b>AU2214</b> Rotbaşı Ön Sağ - Sol Rb2214	4B0419811B, 4B0419811C 4B0419811E, 4B0419811F 4D0419811A, 4D0419811B 4D0419811G, 4D0419811H 4F0419811E, 4F0498811	4B0419811B, 4B0419811C 4B0419811E, 4B0419811F 4D0419811A, 4D0419811B 4D0419811G, 4D0419811H 4F0419811E, 4F0498811	<b>AU2214</b> Rotbaşı Ön Sağ - Sol Rb2214	
	<b>AU4008</b> Z Rot Ön Sağ Alüminyum 90 Rb2921	8D0407318D, 8D0411318D	8D0407317D, 8D0411317D	<b>AU4009</b> Z Rot Ön Sol Alüminyum 90 Rb2920	
	<b>AU5007A</b> Salıncak Ön Üst Sağ Rb2629	4D0407510B, 4D0407510D 4D0407510F, 4D0407510G 4D0407510H, 4D0407510J 4D0407510K, 8D0407510A 8D0407510C, 8D0407510E	4D0407509F, 4D0407509G 4D0407509J, 4D0407509K 8D0407509C, 8D0407509E 8E0407509A	<b>AU5008A</b> Salıncak Ön Üst Sol Rb2628	
	<b>AU5009A</b> Salıncak Ön Üst Sağ Rb2635	8D0407506A, 8D0407506B 8E0407506A, 8E0407506P	8D0407505A, 8E0407505A 8E0407505P	<b>AU5010A</b> Salıncak Ön Üst Sol Rb2634	
	<b>AU5011</b> Salıncak Ön Alt Sağ Rb2637	4D0407694AC, 4D0407694AD 4D0407694E, 4D0407694H 4D0407694K, 4D0407694M 4D0407694N, 8E0407694 8E0407694AG, 8E0407694E	4D0407693AC, 4D0407693AD 4D0407693E, 4D0407693H 4D0407693K, 4D0407693M 4D0407693N, 8E0407693 8E0407693AG, 8E0407693E	<b>AU5012</b> Salıncak Ön Alt Sol Rb2636	
	<b>AU5013</b> Salıncak Ön Alt Ön Taraf Sol Ve Sağ Alüminyum Rb2616	4B3407151C, 4B3407151E 4D0407151G, 4D0407151H 4D0407151J	4B3407151C, 4B3407151E 4D0407151G, 4D0407151H 4D0407151J	<b>AU5013</b> Salıncak Ön Alt Ön Taraf Sol Ve Sağ Alüminyum Rb2616	

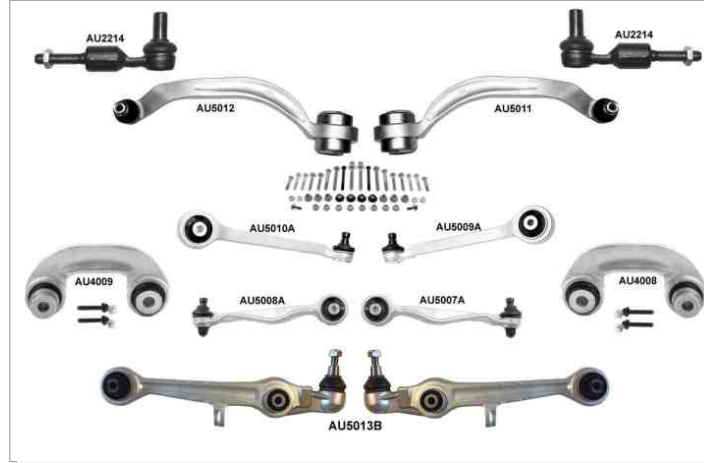
## AU8002 / Süspansiyon Kit Ön

**A6**
**4B, C5**
**1997 - 2005**

**OEM**

4B3498998, 4B3498998-S1, 8B0498998S1











### Kit Parçaları

Resim	Ürün Kodu / Adı	OEM	OEM	Ürün Kodu / Adı	Resim
	<b>AU2214</b> Rotbaşı Ön Sağ - Sol Rb2214	4B0419811B, 4B0419811C 4B0419811E, 4B0419811F 4D0419811A, 4D0419811B 4D0419811G, 4D0419811H 4F0419811E, 4F0498811	4B0419811B, 4B0419811C 4B0419811E, 4B0419811F 4D0419811A, 4D0419811B 4D0419811G, 4D0419811H 4F0419811E, 4F0498811	<b>AU2214</b> Rotbaşı Ön Sağ - Sol Rb2214	
	<b>AU4008</b> Z Rot Ön Sağ Alüminyum 90 Rb2921	8D0407318D, 8D0411318D	8D0407317D, 8D0411317D	<b>AU4009</b> Z Rot Ön Sol Alüminyum 90 Rb2920	
	<b>AU5007A</b> Salıncak Ön Üst Sağ Rb2629	4D0407510B, 4D0407510D 4D0407510F, 4D0407510G 4D0407510H, 4D0407510J 4D0407510K, 8D0407510A 8D0407510C, 8D0407510E	4D0407509F, 4D0407509G 4D0407509J, 4D0407509K 8D0407509C, 8D0407509E 8E0407509A	<b>AU5008A</b> Salıncak Ön Üst Sol Rb2628	
	<b>AU5009A</b> Salıncak Ön Üst Sağ Rb2635	8D0407506A, 8D0407506B 8E0407506A, 8E0407506P	8D0407505A, 8E0407505A 8E0407505P	<b>AU5010A</b> Salıncak Ön Üst Sol Rb2634	
	<b>AU5011</b> Salıncak Ön Alt Sağ Rb2637	4D0407694AC, 4D0407694AD 4D0407694E, 4D0407694H 4D0407694K, 4D0407694M 4D0407694N, 8E0407694 8E0407694AG, 8E0407694E	4D0407693AC, 4D0407693AD 4D0407693E, 4D0407693H 4D0407693K, 4D0407693M 4D0407693N, 8E0407693 8E0407693AG, 8E0407693E	<b>AU5012</b> Salıncak Ön Alt Sol Rb2636	
	<b>AU5013B</b> Salıncak Ön Alt Ön Taraf Sol Ve Sağ Alüminyum Rb2641	4B3407151C, 4B3407151K	4B3407151C, 4B3407151K	<b>AU5013B</b> Salıncak Ön Alt Ön Taraf Sol Ve Sağ Alüminyum Rb2641	

A6	4B, C5	1997 - 2005	
Resim	Ürün Kodu ve Açıklaması	Detay	OEM
	<b>AU22143002</b> ROT TAKIMI ÖN AKS RB288115	Ağırlık : 1,043 kg / 2.299 lb Rotbaşı : AU2214 Rotmili : AU3002	1J0422812A, 4B0419801B 4B0419801E, 4B0419801M 4D0419801B, 4D0419801C 4D0419801D, 4D0419801L
	<b>AU22143011</b> ROT TAKIMI <<ŞASE (ÖN / ARKA)>> ÖN	Ağırlık : 1.026 kg / 2.262 lb Rotbaşı : AU2214 Rotmili : AU3011	8E0419801B
	<b>AU2214A3002</b> ROT TAKIMI ÖN AKS RB288136	Ağırlık : 1,026 kg / 2.262 lb Rotbaşı : AU2214 Rotmili : AU3002	4B0419801G, 4B0419801N 4D0419801Q, 8E0419801B
	<b>AU22173002</b> ROT TAKIMI ÖN	Ağırlık : 0,916 kg / 2.019 lb Rotbaşı : AU2217 Rotmili : AU3002	4B0419801E, 4B0419801G 4F0419811D, 4F0422821D 4F0498811A, 4F0498811C 8E0419801B, 8E0419811
	<b>AU22173011</b> ROT TAKIMI ÖN AKS	Ağırlık : 0.97 kg / 2.138 lb Rotbaşı : AU2217 Rotmili : AU3011	8E0419801E, 8E0419801N
	<b>AU4007</b> Z ROT ÖN SAĞ-SOL ALİMİNYUM 90 RB2942	Ağırlık : 0,378 kg / 0.833 lb Malzeme Türü : Alüminyum Uzunluk : 86 mm / 3.39 inch Aşık Diş Çapı : M10X1,5	4D0411317G, 4D0411317J 4D0411317K
	<b>AU4008</b> Z ROT ÖN SAĞ ALİMİNYUM 90 RB2921	Ağırlık : 0,347 kg / 0.765 lb Malzeme Türü : Alüminyum Uzunluk : 90 mm / 3.54 inch	8D0407318D, 8D0411318D
	<b>AU4009</b> Z ROT ÖN SOL ALİMİNYUM 90 RB2920	Ağırlık : 0,347 kg / 0.765 lb Malzeme Türü : Alüminyum Uzunluk : 90 mm / 3.54 inch	8D0407317D, 8D0411317D
	<b>AU4010</b> Z ROT ÖN SAĞ-SOL ALİMİNYUM 90 RB2912	Ağırlık : 0,325 kg / 0.717 lb Malzeme Türü : Alüminyum Uzunluk : 90 mm / 3.54 inch	4D0411317J, 4D0411317K
	<b>AU5007</b> SALINCAK ÖN ÜST SAĞ	Malzeme Türü : Alüminyum	4D0407510B, 4D0407510D
	<b>AU5007A</b> SALINCAK ÖN ÜST SAĞ RB2629	Ağırlık : 0,460 kg / 1.014 lb Malzeme Türü : Alüminyum	4D0407510B, 4D0407510D 4D0407510F, 4D0407510G 4D0407510H, 4D0407510J 4D0407510K, 8D0407510A 8D0407510C, 8D0407510E

\* Bu sayfada ve katalogdaki tüm araçların adları, markaları, modelleri, sembolleri, logoları, orijinal numaraları (oe) ve diğer üçüncü parti numaraları sadece referans amaçlı kullanılmaktadır.

**A6** **4B, C5** **1997 - 2005**

Resim	Ürün Kodu ve Açıklaması	Detay	OEM
	<b>AU5008</b> SALINCAK ÖN ÜST SOL	Malzeme Türü : Alüminyum	4D0407509B, 4D0407509D
	<b>AU5008A</b> SALINCAK ÖN ÜST SOL RB2628	Ağırlık : 0,460 kg / 1.014 lb Malzeme Türü : Alüminyum	4D0407509F, 4D0407509G 4D0407509J, 4D0407509K 8D0407509C, 8D0407509E 8E0407509A
	<b>AU5009</b> SALINCAK ÖN ÜST SAĞ RB2630	Malzeme Türü : Alüminyum	8D0407506B, 8D0407506F 8D0407506H, 8D0407506K
	<b>AU5009A</b> SALINCAK ÖN ÜST SAĞ RB2635	Ağırlık : 0,488 kg / 1.076 lb Malzeme Türü : Alüminyum	8D0407506A, 8D0407506B 8E0407506A, 8E0407506P
	<b>AU5010</b> SALINCAK ÖN ÜST SOL RB2631	Malzeme Türü : Alüminyum	8D0407505B, 8D0407505F 8D0407505H, 8D0407505K
	<b>AU5010A</b> SALINCAK ÖN ÜST SOL RB2634	Ağırlık : 0,488 kg / 1.076 lb Malzeme Türü : Alüminyum	8D0407505A, 8E0407505A 8E0407505P
	<b>AU5011</b> SALINCAK ÖN ALT SAĞ RB2637	Ağırlık : 1,750 kg / 3.858 lb Malzeme Türü : Alüminyum	4D0407694AC, 4D0407694AD 4D0407694E, 4D0407694H 4D0407694K, 4D0407694M 4D0407694N, 8E0407694 8E0407694AG, 8E0407694E
	<b>AU5012</b> SALINCAK ÖN ALT SOL RB2636	Ağırlık : 1,800 kg / 3.968 lb Malzeme Türü : Alüminyum	4D0407693AC, 4D0407693AD 4D0407693E, 4D0407693H 4D0407693K, 4D0407693M 4D0407693N, 8E0407693 8E0407693AG, 8E0407693E
	<b>AU5013</b> SALINCAK ÖN ALT ÖN TARAF SOL VE SAĞ ALÜMİNYUM RB2616	Ağırlık : 1,520 kg / 3.351 lb Malzeme Türü : Alüminyum	4B3407151C, 4B3407151E 4D0407151G, 4D0407151H 4D0407151J
	<b>AU5013A</b> SALINCAK ÖN ALT ÖN TARAF SOL VE SAĞ ALÜMİNYUM RB2648	Ağırlık : 1,504 kg / 3.316 lb Malzeme Türü : Alüminyum	8E0407151E, 8E0407151K 8E0407151L, 8E0407151M 8E0407151N, 8E0407151R 8E0407151J
	<b>AU5013B</b> SALINCAK ÖN ALT ÖN TARAF SOL VE SAĞ ALÜMİNYUM RB2641	Ağırlık : 1,500 kg / 3.307 lb Malzeme Türü : Alüminyum	4B3407151C, 4B3407151K

\* Bu sayfada ve katalogdaki tüm araçların adları, markaları, modelleri, sembolleri, logoları, orjinal numaraları (oe) ve diğer üçüncü parti numaraları sadece referans amaçlı kullanılmaktadır.

A6	4B, C5	1997 - 2005	
Resim	Ürün Kodu ve Açıklaması	Detay	OEM
	<b>AU9001</b> SALINCAK ARKA	Ağırlık : 0,546 kg / 1.204 lb Malzeme Türü : Sac Metal	8K0501529L
	<b>AU11003</b> SALINCAK VE DENGE KOLU BURCU ÖN ÜST SOL VE SAĞ B22115	Şasi (Ön / Arka) : ÖN Yön : Üst Sol Ve Sağ Ağırlık : 0,075 kg / 0.165 lb	4B0407515, 4B0407515A 4D0407515C*, 4D0407515C
	<b>AU11004</b> SALINCAK VE DENGE KOLU BURCU ÖN ORTA SOL VE SAĞ B22112	Şasi (Ön / Arka) : ÖN Yön : Orta Sol Ve Sağ Ağırlık : 0,112 kg / 0.247 lb	4D0407181F, 4D0407181H
	<b>AU11006</b> SALINCAK VE DENGE KOLU BURCU ÖN SOL VE SAĞ	Şasi (Ön / Arka) : ÖN Yön : Sol Ve Sağ Ağırlık : 0,225 kg / 0.496 lb	4D0407182E, 4D0407182G 8E0407182A, 8E0407182E
	<b>AU11007</b> SALINCAK VE DENGE KOLU BURCU ÖN ALT SOL VE SAĞ	Şasi (Ön / Arka) : ÖN Yön : Alt Sol Ve Sağ Ağırlık : 0,59 kg / 1.301 lb	4D0407183AB, 4D0407183AC 4D0407183D, 4D0407183M 4D0407183N, 4D0407183P 4D0407183S
	<b>AU11036</b> SALINCAK VE DENGE KOLU BURCU ÖN SOL VE SAĞ	Şasi (Ön / Arka) : ÖN Yön : Sol Ve Sağ Ağırlık : 0,25 kg / 0.551 lb Not : DENGE KOLU BURCU	4H0407515, 8D0407515A 8K0407515, 8R0407515
	<b>VW11052</b> SALINCAK VE DENGE KOLU BURCU ALT SOL VE SAĞ B22130	Yön : Alt Sol Ve Sağ Ağırlık : 0,523 kg / 1.153 lb	4D0407183M, 4D0407183N 4D0407183P, 4D0407183Q 4E0407183M
	<b>AU11091</b> ROTMİLİ BURCU VE LASTİĞİ		4B0419811E*, 4B0419811F* 4D0419811A*, 4D0419811B* 4F0419811B*, 4F0419811E* 4F0498811*, 8E0419811B*
	<b>AU12029</b> ROTMİLİ BURCU VE LASTİĞİ ÖN	Şasi (Ön / Arka) : ÖN	171419804*, 171419804A* 175419804*
	<b>AU12029K</b> ROTMİLİ BURCU VE LASTİĞİ ÖN	Şasi (Ön / Arka) : ÖN	171419804*, 171419804A* 175419804*
	<b>AU12028</b> TAŞIYICI DESTEK BURÇLARI ARKA	Şasi (Ön / Arka) : ARKA Ağırlık : 0,155 kg / 0.342 lb	4A0511249

\* Bu sayfada ve katalogdaki tüm araçların adları, markaları, modelleri, sembolleri, logoları, orjinal numaraları (oe) ve diğer üçüncü parti numaraları sadece referans amaçlı kullanılmaktadır.







**A6 4B, C5 1997 - 2005**

Resim	Ürün Kodu ve Açıklaması	Detay	OEM
	<b>VW11053</b> TAŞIYICI DESTEK BURÇLARI SAĞ	Yön : Sağ Diğer Taraf : VW11054 Ağırlık : 1.49 kg / 3.285 lb	4B0501522D, 4B0501522E 8E0501522C, 8E0501522F 8E0501522J, 8E0501522L 8E0501522N
	<b>VW11054</b> TAŞIYICI DESTEK BURÇLARI SOL	Yön : Sol Diğer Taraf : VW11053 Ağırlık : 1.49 kg / 3.285 lb	4B0501521D, 4B0501521E 8E0501521C, 8E0501521F 8E0501521J, 8E0501521L 8E0501521N
	<b>AU12005</b> VİRAJ DEMİR LASTİĞİ SOL VE SAĞ RUBBER	Şasi (Ön / Arka) : ÖN Yön : Sol Ve Sağ Ağırlık : 0.06 kg / 0.132 lb Malzeme Türü : Rubber	4D0411327F, 4D0411327H
	<b>AU12005K</b> VİRAJ DEMİR LASTİĞİ SOL VE SAĞ RUBBER	Şasi (Ön / Arka) : ÖN Yön : Sol Ve Sağ Ağırlık : 0.12 kg / 0.265 lb Malzeme Türü : Rubber	4D0411327F, 4D0411327H
	<b>VW12022</b> AMORTİSÖR TAKOZU SOL VE SAĞ AMORTİSÖR TAKOZU	Yön : Sol Ve Sağ Ağırlık : 0.44 kg / 0.970 lb Not : AMORTİSÖR TAKOZU	4D0412377F
	<b>AU12033</b> MOTOR TAKOZU ÖN	Şasi (Ön / Arka) : ÖN Ağırlık : 0,825 kg / 1.819 lb	4B0199379A, 4B0199379E
	<b>VW12031</b> MOTOR TAKOZU SOL VE SAĞ MOTOR TAKOZU	Yön : Sol Ve Sağ Ağırlık : 0.831 kg / 1.832 lb Not : Motor takozu	8D0199379K
	<b>VW12039</b> MOTOR TAKOZU SOL VE SAĞ MOTOR TAKOZU	Yön : Sol Ve Sağ Ağırlık : 0.816 kg / 1.799 lb Not : MOTOR TAKOZU	8D0199379C, 8D0199382AC 8D0199382AE, 8D0199382AP 8D0199382AR, 8D0199382C 8D0199382G, 8D0199382K 8D0199382M, 8D0199382S
	<b>VW12071</b> MOTOR TAKOZU SOL VE SAĞ MOTOR TAKOZU	Yön : Sol Ve Sağ Ağırlık : 0.475 kg / 1.047 lb Not : MOTOR TAKOZU	8D0399151H
	<b>AU12035</b> ŞANZİMAN TAKOZU	Ağırlık : 0,490 kg / 1.080 lb	4B0399151L, 4B0399151M 8E0399151D
	<b>AU12006</b> SÜSPANSİYON TAKOZU ARKA SOL VE SAĞ	Şasi (Ön / Arka) : ARKA Yön : Sol Ve Sağ Ağırlık : 0.55 kg / 1.213 lb	1J0 512 131 B, 1J0 513 025 Q 1J0512131B, 1J0513025Q

\* Bu sayfada ve katalogdaki tüm araçların adları, markaları, modelleri, sembolleri, logoları, orjinal numaraları (oe) ve diğer üçüncü parti numaraları sadece referans amaçlı kullanılmaktadır.

**A6 4B, C5 1997 - 2005**

Resim	Ürün Kodu ve Açıklaması	Detay	OEM
	<b>VW13001</b> DİREKSİYON KÖRÜĞÜ	Ağırlık : 0.065 kg / 0.143 lb	4D0419831
	<b>VW13009</b> DİREKSİYON KÖRÜĞÜ	Ağırlık : 0.19 kg / 0.419 lb	8D0419831J, 8D0419831K
	<b>VW14001</b> AKS KÖRÜĞÜ +KELEPÇE+YAĞ. DIŞ	Ağırlık : 0.14 kg / 0.309 lb	441 407 203A, 441407203A
	<b>VW14008</b> AKS KÖRÜĞÜ +KELEPÇE+YAĞ. DIŞ		3B0407203A
	<b>VW14012</b> AKS KÖRÜĞÜ +KELEPÇE+YAĞ. DIŞ	Ağırlık : 0.175 kg / 0.386 lb	3B0498203A, 4A0498203C 8D0498203A

**A6 4F2, C6 2005 - 2011**



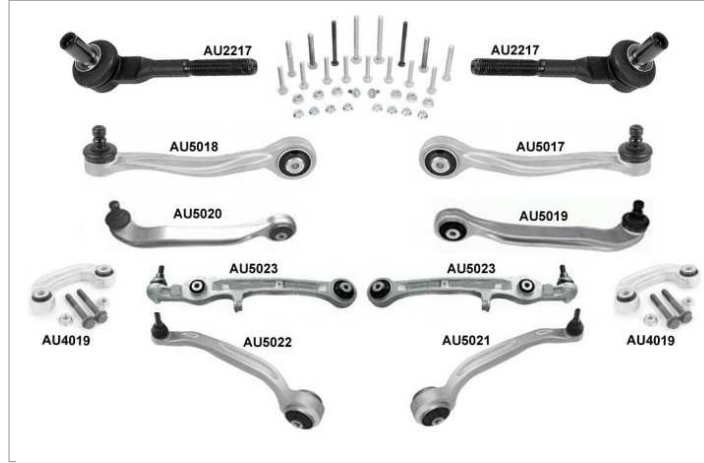







Resim	Ürün Kodu ve Açıklaması	Detay	OEM
	<b>AU2217</b> ROTBAŞI SAĞ-SOL RB2217	Ağırlık : 0,414 kg / 0.913 lb Uzunluk : 155 mm / 6.10 inch Gövde Diş Çapı : M14X1,5 Aşık Diş Çapı : M8X1,25 Aşık Konik Çapı : Ø17,5	4B0419811G, 4D0419811J 4F0419811C, 4F0419811D 4F0498811, 4F0498811A 8E0419811
	<b>AU3005</b> ROTMİLİ	Ağırlık : 0,451 kg / 0.994 lb Uzunluk : 140 mm / 5.51 inch Gövde Diş Çapı : M16X1,5 Aşık Diş Çapı : M14X1,5	4F0422821, 4F0422821D

**AU8006 / Süspansiyon Kit Ön**
**A6**
**4F2, C6**
**2005 - 2011**

**OEM**

8F0498998

**Kit Parçaları**

Resim	Ürün Kodu / Adı	OEM	OEM	Ürün Kodu / Adı	Resim
	<b>AU2217</b> Rotbaşı Sağ-sol Rb2217	4B0419811G, 4D0419811J 4F0419811C, 4F0419811D 4F0498811, 4F0498811A 8E0419811	4B0419811G, 4D0419811J 4F0419811C, 4F0419811D 4F0498811, 4F0498811A 8E0419811	<b>AU2217</b> Rotbaşı Sağ-sol Rb2217	
	<b>AU4019</b> Rb2930 Rıw Z Rot Ön Sağ-sol	4E0411317C, 4E0411317D 4E0411317E	4E0411317C, 4E0411317D 4E0411317E	<b>AU4019</b> Rb2930 Rıw Z Rot Ön Sağ-sol	
	<b>AU5017</b> Salıncak Ön Üst Sağ Rb2651	4E0407510B	4E0407509B	<b>AU5018</b> Salıncak Ön Üst Sol Rb2650	
	<b>AU5019</b> Salıncak Ön Üst Önden Sağ Rb2643	4E0407506B	4E0407505B	<b>AU5020</b> Salıncak Ön Üst Önden Sol Rb2642	
	<b>AU5021</b> Salıncak Ön Alt Sağ Rb2653	4F0407694, 4F0407694B 4F0407694C	4F0407693, 4F0407693B 4F0407693C	<b>AU5022</b> Salıncak Ön Alt Sol Rb2654	
	<b>AU5023</b> Salıncak Ön Alt Rb2652	4F0407151, 4F0407151A			

A6	4F2, C6	2005 - 2011	
Resim	Ürün Kodu ve Açıklaması	Detay	OEM
	<b>AU22173005</b> ROT TAKIMI ÖN	Ağırlık : 0,88 kg / 1.940 lb Rotbaşı : AU2217 Rotmilii : AU3005	4F0419811C*, 4F0419811C-P
	<b>AU4017</b> Z ROT ARKA PLASTİK L=62,5	Ağırlık : 0,112 kg / 0.247 lb Uzunluk : 62,5 mm / 2.46 inch Not : PLASTİK	8E0505465D
	<b>AU4018</b> Z ROT	Ağırlık : 0,19 kg / 0.419 lb Uzunluk : 62,5 mm / 2.46 inch	4F0505465N
	<b>AU4019</b> RB2930 RIW Z ROT ÖN SAĞ-SOL	Ağırlık : 0,353 kg / 0.778 lb Malzeme Türü : Alüminyum Uzunluk : 110 mm / 4.33 inch	, 4E0411317C 4E0411317D, 4E0411317E
	<b>AU4020</b> Z ROT ARKA 100 RB2933	Ağırlık : 0,294 kg / 0.648 lb Uzunluk : 100 mm / 3.94 inch Aşık Diş Çapı : M10X1,5	4F0505465P
	<b>AU5017</b> SALINCAK ÖN ÜST SAĞ RB2651	Malzeme Türü : Alüminyum	4E0407510B
	<b>AU5018</b> SALINCAK ÖN ÜST SOL RB2650	Malzeme Türü : Alüminyum	4E0407509B
	<b>AU5019</b> SALINCAK ÖN ÜST ÖNDEN SAĞ RB2643	Malzeme Türü : Alüminyum	4E0407506B
	<b>AU5020</b> SALINCAK ÖN ÜST ÖNDEN SOL RB2642	Malzeme Türü : Alüminyum	4E0407505B
	<b>AU5021</b> SALINCAK ÖN ALT SAĞ RB2653	Malzeme Türü : Alüminyum	4F0407694, 4F0407694B 4F0407694C
	<b>AU5022</b> SALINCAK ÖN ALT SOL RB2654	Malzeme Türü : Alüminyum	4F0407693, 4F0407693B 4F0407693C









\* Bu sayfada ve katalogdaki tüm araçların adları, markaları, modelleri, sembolleri, logoları, orjinal numaraları (oe) ve diğer üçüncü parti numaraları sadece referans amaçlı kullanılmaktadır.

**A6 4F2, C6 2005 - 2011**

Resim	Ürün Kodu ve Açıklaması	Detay	OEM
	<b>AU5023</b> SALINCAK ÖN ALT RB2652	Malzeme Türü : Alüminyum	4F0407151, 4F0407151A
	<b>AU9008</b> SALINCAK ARKA ALT	Ağırlık : 1,25 kg / 2.756 lb Malzeme Türü : Sac Metal	4F0501529C, 4F0501529E
	<b>AU11032</b> SALINCAK VE DENGE KOLU BURCU ÖN SOL VE SAĞ	Şasi (Ön / Arka) : ÖN Yön : Sol Ve Sağ Ağırlık : 0,17 kg / 0.375 lb Not : DENGE KOLU BURCU	4D0407183L, 4F0407183A 4F0407183B, 4F0407183E
	<b>AU11036</b> SALINCAK VE DENGE KOLU BURCU ÖN SOL VE SAĞ	Şasi (Ön / Arka) : ÖN Yön : Sol Ve Sağ Ağırlık : 0,25 kg / 0.551 lb Not : DENGE KOLU BURCU	4H0407515, 8D0407515A 8K0407515, 8R0407515
	<b>AU11042</b> SALINCAK VE DENGE KOLU BURCU ALT SOL VE SAĞ	Yön : Alt Sol Ve Sağ Ağırlık : 0,16 kg / 0.353 lb	4E0407182C
	<b>AU11043</b> SALINCAK VE DENGE KOLU BURCU ÖN ALT ORTA SOL VE SAĞ B22137	Şasi (Ön / Arka) : ÖN Yön : Alt Orta Sol Ve Sağ Ağırlık : 0,1 kg / 0.220 lb	4E0407181B
	<b>AU11045</b> SALINCAK VE DENGE KOLU BURCU ÜST SOL VE SAĞ	Yön : Üst Sol Ve Sağ Ağırlık : 0,1 kg / 0.220 lb	4E0407515D, 8D0407515B 8K0407515
	<b>AU11095</b> Z-ROT BURCU ARKA	Şasi (Ön / Arka) : ARKA Ağırlık : 0,040 kg / 0.088 lb Z Rot 1 : AU4018 Z Rot 2 : AU4020	4F0505465N*, 4F0505465P* 4F0505465Q*
	<b>AU12004</b> VİRAJ DEMİR LASTİĞİ SOL VE SAĞ RUBBER	Şasi (Ön / Arka) : ÖN Yön : Sol Ve Sağ Ağırlık : 0.074 kg / 0.163 lb Malzeme Türü : Rubber Not : INTERNAL DIAMETER=Ø29mm	4D0411327J
	<b>AU12004K</b> VİRAJ DEMİR LASTİĞİ SOL VE SAĞ RUBBER	Şasi (Ön / Arka) : ÖN Yön : Sol Ve Sağ Ağırlık : 0.148 kg / 0.326 lb Malzeme Türü : Rubber	4D0411327J
	<b>AU12044</b> SÜSPANSİYON TAKOZU ARKA	Şasi (Ön / Arka) : ARKA Ağırlık : 0,125 kg / 0.276 lb	4F0512131D, 4F0512131G











\* Bu sayfada ve katalogdaki tüm araçların adları, markaları, modelleri, sembolleri, logoları, orjinal numaraları (oe) ve diğer üçüncü parti numaraları sadece referans amaçlı kullanılmaktadır.

A6		4F2, C6		2005 - 2011	
Resim	Ürün Kodu ve Açıklaması	Detay	OEM		
	<b>VW14011</b> AKS KÖRÜĞÜ +KELEPÇE+YAĞ. İÇ	Ağırlık : 0.236 kg / 0.520 lb	1K0498201D		

A6		4G2, C7		2011 - 2017	
Resim	Ürün Kodu ve Açıklaması	Detay	OEM		
	<b>AU1019</b> ROTİL ÖN ALT SAĞ - SOL Ø17	Ağırlık : 0,505 kg / 1.113 lb Konik Ölçüsü : Ø17 Aşık Diş Çapı : M14X1,5 Rotil Gövde Çapı : Ø42	4G0407689A, 4G0407689C 8W0407689B		
	<b>AU2019</b> ROTBAŞI SAĞ M16X1,5 RHT	Ağırlık : 0,78 kg / 1.720 lb Uzunluk : 209 mm / 8.23 inch Gövde Diş Çapı : M16X1,5 Aşık Diş Çapı : M12X1,5 Aşık Konik Çapı : Ø14,7	4G0423812A		
	<b>AU2020</b> ROTBAŞI SOL M16X1,5 RHT	Ağırlık : 0,78 kg / 1.720 lb Uzunluk : 209 mm / 8.23 inch Gövde Diş Çapı : M16X1,5 Aşık Diş Çapı : M12X1,5 Aşık Konik Çapı : Ø14,7	4G0423811A		
	<b>AU3009</b> ROTMİLİ SAĞ-SOL M16X1,5 L=236	Ağırlık : 0,617 kg / 1.360 lb Uzunluk : 236 mm / 9.29 inch Gövde Diş Çapı : M16X1,5 Aşık Diş Çapı : M16X1,5	4G0423810A		
	<b>AU4023</b> Z ROT SOL VE SAĞ PLASTİK RB2947	Ağırlık : 0,117 kg / 0.258 lb Malzeme Türü : Plastik Uzunluk : 62 mm / 2.44 inch	8K0505465E, 8K0505465G		
	<b>AU4024</b> Z ROT ARKA SAĞ	Ağırlık : 0,508 kg / 1.120 lb Uzunluk : 282,5 mm / 11.12 inch	8K0501530K, 8K0501530N		
	<b>AU4025</b> Z ROT ARKA SOL	Ağırlık : 0,508 kg / 1.120 lb Uzunluk : 282,5 mm / 11.12 inch	8K0501529K, 8K0501529N		
	<b>AU4026</b> Z ROT ÖN DENGE ROTU 170 RB2944	Ağırlık : 0,185 kg / 0.408 lb Malzeme Türü : Denge Rotu Uzunluk : 170 mm / 6.69 inch	8K0411317C, 8K0411317D 8K0411317E		
	<b>AU4029</b> Z ROT ÖN	Ağırlık : 0,138 kg / 0.304 lb Uzunluk : 170 mm / 6.69 inch	8K0411317D, 8K0411317E		

\* Bu sayfada ve katalogdaki tüm araçların adları, markaları, modelleri, sembolleri, logoları, orjinal numaraları (oe) ve diğer üçüncü parti numaraları sadece referans amaçlı kullanılmaktadır.

**A6**
**4G2, C7**
**2011 - 2017**

Resim	Ürün Kodu ve Açıklaması	Detay	OEM
	<b>AU4031</b> Z ROT ÖN ALÜMİNYUM L=170	Ağırlık : 0,201 kg / 0.443 lb Malzeme Türü : Alüminyum Uzunluk : 170 mm / 6.69 inch	4G0411317A, 4G0411317C 4M0411317
	<b>AU5027</b> SALINCAK ÖN ALT SAĞ	Malzeme Türü : Alüminyum	8K0407152B, 8K0407152C 8K0407152D
	<b>AU5028</b> SALINCAK ÖN ALT SOL	Malzeme Türü : Alüminyum	8K0407151B
	<b>AU5041</b> SALINCAK ÖN ALT SAĞ	Malzeme Türü : Alüminyum	4G0407694D, 4G0407694F 4G0407694H, 4G0407694J 4G0407694L
	<b>AU5042</b> SALINCAK ÖN ALT SOL	Malzeme Türü : Alüminyum	4G0407693D, 4G0407693F 4G0407693H, 4G0407693J 4G0407693L
	<b>AU5043</b> SALINCAK ÖN ÜST SAĞ	Malzeme Türü : Alüminyum	8K0407506M
	<b>AU5044</b> SALINCAK ÖN ÜST SOL	Malzeme Türü : Alüminyum	8K0407505M
	<b>AU5045</b> SALINCAK ÖN ÜST SAĞ	Malzeme Türü : Alüminyum	8K0407510M
	<b>AU5046</b> SALINCAK ÖN ÜST SOL	Malzeme Türü : Alüminyum	8K0407509M
	<b>AU5047</b> SALINCAK ARKA ÜST SAĞ	Malzeme Türü : Alüminyum	8K0505324H
	<b>AU5048</b> SALINCAK ARKA ÜST SOL	Malzeme Türü : Alüminyum	8K0505323H

\* Bu sayfada ve katalogdaki tüm araçların adları, markaları, modelleri, sembolleri, logoları, orjinal numaraları (oe) ve diğer üçüncü parti numaraları sadece referans amaçlı kullanılmaktadır.

**A6 4G2, C7 2011 - 2017**

Resim	Ürün Kodu ve Açıklaması	Detay	OEM
	<b>AU5062</b> SALINCAK ÖN ALT SAĞ	Ağırlık : 1,3 kg / 2.866 lb Malzeme Türü : Alüminyum	8K0407152B, 8K0407152C 8K0407152D, 8K0407152E
	<b>AU5063</b> SALINCAK ÖN ALT SOL	Ağırlık : 1,3 kg / 2.866 lb Malzeme Türü : Alüminyum	8K0407151D
	<b>AU11036</b> SALINCAK VE DENGE KOLU BURCU ÖN SOL VE SAĞ	Şasi (Ön / Arka) : ÖN Yön : Sol Ve Sağ Ağırlık : 0,25 kg / 0.551 lb Not : DENGE KOLU BURCU	4H0407515, 8D0407515A 8K0407515, 8R0407515
	<b>AU11043</b> SALINCAK VE DENGE KOLU BURCU ÖN ALT ORTA SOL VE SAĞ B22137	Şasi (Ön / Arka) : ÖN Yön : Alt Orta Sol Ve Sağ Ağırlık : 0,1 kg / 0.220 lb	4E0407181B
	<b>AU11054</b> SALINCAK VE DENGE KOLU BURCU SOL VE SAĞ	Yön : Sol Ve Sağ Ağırlık : 0,172 kg / 0.379 lb Not : SALINCAK BURCU	8K0407151B*, 8K0407151B 8K0407152B*
	<b>AU11060</b> SALINCAK VE DENGE KOLU BURCU ÖN ALT SOL VE SAĞ	Şasi (Ön / Arka) : ÖN Yön : Alt Sol Ve Sağ Ağırlık : 0,248 kg / 0.547 lb	4G0407183, 4G0407183A 4H0407183, 4H0407183B 4H0407183C
	<b>AU11025</b> Z-ROT BURCU ARKA SOL VE SAĞ	Şasi (Ön / Arka) : ARKA Yön : Sol Ve Sağ Ağırlık : 0.032 kg / 0.071 lb Uzunluk : AU4023 mm / 0.00 inch	8K0505465E*, 8K0505465G*
	<b>AU11053</b> Z-ROT BURCU SOL VE SAĞ	Yön : Sol Ve Sağ Ağırlık : 0,082 kg / 0.181 lb Uzunluk : AU9001 mm / 0.00 inch Aşık Dış Çapı : AU4024 Not : AU4025	8K0501529N*, 8K0501530N*
	<b>AU12049</b> VİRAJ DEMİR LASTİĞİ	Şasi (Ön / Arka) : ÖN Ağırlık : 0,060 kg / 0.132 lb	8K0411327B
	<b>AU12049K</b> VİRAJ DEMİR LASTİĞİ	Şasi (Ön / Arka) : ÖN Ağırlık : 0,120 kg / 0.265 lb	8K0411327B
	<b>AU12050</b> VİRAJ DEMİR LASTİĞİ	Şasi (Ön / Arka) : ÖN Ağırlık : 0,059 kg / 0.130 lb	8K0411327A

\* Bu sayfada ve katalogdaki tüm araçların adları, markaları, modelleri, sembolleri, logoları, orijinal numaraları (oe) ve diğer üçüncü parti numaraları sadece referans amaçlı kullanılmaktadır.













**A6 4G2, C7 2011 - 2017**

Resim	Ürün Kodu ve Açıklaması	Detay	OEM
	<b>AU12050K</b> VİRAJ DEMİR LASTİĞİ	Şasi (Ön / Arka) : ÖN Ağırlık : 0,118 kg / 0.260 lb	8K0411327A
	<b>AU12031</b> MOTOR TAKOZU ÖN SOL	Şasi (Ön / Arka) : ÖN Yön : Sol Ağırlık : 1,575 kg / 3.472 lb	4G0199381, 4G0199381KT 4G0199381LC, 4G0199381LG 4G0199381LH, 4G0199381NT
	<b>AU12046</b> ŞANZIMAN TAKOZU	Ağırlık : 1,156 kg / 2.549 lb	4G0399153T, 4M0399153AE
	<b>AU12048</b> ŞANZIMAN TAKOZU ARKA ORTA	Şasi (Ön / Arka) : ARKA Yön : Orta Ağırlık : 0,641 kg / 1.413 lb	8K0399151BF, 8K0399151CD 8K0399151DB
	<b>AU12038</b> SÜSPANSİYON TAKOZU ARKA	Şasi (Ön / Arka) : ARKA Ağırlık : 0,095 kg / 0.209 lb	8K0512131B, 8T0513028AB 8T0513028R, 8T0513029 8T0513029A
	<b>AU12039</b> SÜSPANSİYON TAKOZU ÖN	Şasi (Ön / Arka) : ÖN Ağırlık : 0,075 kg / 0.165 lb	8K0412131E
	<b>AU12040</b> SÜSPANSİYON TAKOZU ÖN	Şasi (Ön / Arka) : ÖN Ağırlık : 0,075 kg / 0.165 lb	8K0412131F
	<b>AU12043</b> SÜSPANSİYON TAKOZU ÖN	Şasi (Ön / Arka) : ÖN Ağırlık : 0,085 kg / 0.187 lb	4G0412131

**A7 4KA 2018 -**







Resim	Ürün Kodu ve Açıklaması	Detay	OEM
	<b>AU1023</b> ROTİL ALT	Ağırlık : 0,505 kg / 1.113 lb	80A407689B
	<b>AU5089</b> SALINCAK VE DENGE KOLU ÖN ALT ARKADAN SAĞ	Ağırlık : 2,545 kg / 5.611 lb Malzeme Türü : Alüminyum	80A407694B, 80A407694C 80A407694D, 80A407694E 80A407694G

\* Bu sayfada ve katalogdaki tüm araçların adları, markaları, modelleri, sembolleri, logoları, orjinal numaraları (oe) ve diğer üçüncü parti numaraları sadece referans amaçlı kullanılmaktadır.

A7	4KA	2018 -	
Resim	Ürün Kodu ve Açıklaması	Detay	OEM
	<b>AU5090</b> SALINCAK VE DENGE KOLU ÖN ALT ARKADAN SOL	Ağırlık : 2,545 kg / 5.611 lb Malzeme Türü : Alüminyum	80A407693B, 80A407693C 80A407693D, 80A407693E 80A407693G
	<b>AU9031</b> SALINCAK VE DENGE KOLU ARKA ÜST SAĞ ALÜMİNYUM	Ağırlık : 1,545 kg / 3.406 lb Malzeme Türü : Alüminyum	4K0505398A, 4M0505398L
	<b>AU9032</b> SALINCAK VE DENGE KOLU ARKA ÜST SOL ALÜMİNYUM	Ağırlık : 1,545 kg / 3.406 lb Malzeme Türü : Alüminyum	4K0505397A, 4M0505397L
	<b>AU9033</b> SALINCAK ARKA ÖNDEN SAĞ ALÜMİNYUM	Ağırlık : 0,945 kg / 2.083 lb Malzeme Türü : Alüminyum	4M0505292F
	<b>AU9034</b> SALINCAK VE DENGE KOLU ARKA ÖNDEN SOL ALÜMİNYUM	Ağırlık : 0,945 kg / 2.083 lb Malzeme Türü : Alüminyum	4M0505291F
	<b>AU9035</b> SALINCAK VE DENGE KOLU ARKA ÜST SAĞ SAC LEVHA	Ağırlık : 1,245 kg / 2.745 lb Malzeme Türü : Sac Metal	4N0505398A, 80A505398A
	<b>AU9036</b> SALINCAK VE DENGE KOLU ARKA ÜST SOL SAC LEVHA	Ağırlık : 1,245 kg / 2.745 lb Malzeme Türü : Sac Metal	4N0505397A, 80A505397A
	<b>AU11071</b> SALINCAK VE DENGE KOLU BURCU ARKA ALT	Şasi (Ön / Arka) : ARKA Yön : Alt Ağırlık : 0,250 kg / 0.551 lb	4M0501529L*, 4M0501529N* 4M0501530N*
	<b>AU11078</b> SALINCAK VE DENGE KOLU BURCU ARKA ARKA ÜST ARKADAN	Şasi (Ön / Arka) : ARKA Yön : Arka Üst Arkadan Ağırlık : 0,115 kg / 0.254 lb	8W0505397C*, 8W0505397F* 8W0505398C*, 8W0505398F*
	<b>AU11083</b> SALINCAK VE DENGE KOLU BURCU ARKA İÇ ÜST	Şasi (Ön / Arka) : ARKA Yön : İç Üst Ağırlık : 0,105 kg / 0.231 lb	8W0505323F*, 8W0505324F*
	<b>AU11092</b> SALINCAK VE DENGE KOLU BURCU ÖN ALT ARKADAN	Şasi (Ön / Arka) : ÖN Yön : Alt Arkadan Ağırlık : 0,515 kg / 1.135 lb	80A407693B*, 80A407693C* 80A407693D*, 80A407693E* 80A407693G*, 80A407694B* 80A407694C*, 80A407694D* 80A407694E*, 80A407694G*











\* Bu sayfada ve katalogdaki tüm araçların adları, markaları, modelleri, sembolleri, logoları, orjinal numaraları (oe) ve diğer üçüncü parti numaraları sadece referans amaçlı kullanılmaktadır.

A7	4KA	2018 -	
Resim	Ürün Kodu ve Açıklaması	Detay	OEM
	<b>AU11093</b> SALINCAK VE DENG KOLU BURCU ARKA ÖNDEN	Şasi (Ön / Arka) : ARKA Yön : Önden Ağırlık : 0,115 kg / 0.254 lb	4M0505291F*, 4M0505292F*
	<b>AU11094</b> SALINCAK VE DENG KOLU BURCU ARKA ÜST	Şasi (Ön / Arka) : ARKA Yön : Üst Ağırlık : 0,145 kg / 0.320 lb	4N0505397A*, 4N0505398A* 80A505397A*, 80A505398A*
	<b>AU12040</b> SÜSPANSİYON TAKOZU ÖN	Şasi (Ön / Arka) : ÖN Ağırlık : 0,075 kg / 0.165 lb	8K0412131F
	<b>AU12045</b> SÜSPANSİYON TAKOZU ÖN	Şasi (Ön / Arka) : ÖN Ağırlık : 0,075 kg / 0.165 lb	8R0412131E

A7 Sportback	4GA, AGF	2010 - 2018	
Resim	Ürün Kodu ve Açıklaması	Detay	OEM
	<b>AU1016</b> ROTİL ÖN ALT SAĞ - SOL Ø13,8 RB2411	Ağırlık : 0,5 kg / 1.102 lb Konik Ölçüsü : Ø13,8 Aşık Diş Çapı : M12X1,5 Rotil Gövde Çapı : Ø42	8K0407689E, 8K0407689F 8K0407689G
	<b>AU1019</b> ROTİL ÖN ALT SAĞ - SOL Ø17	Ağırlık : 0,505 kg / 1.113 lb Konik Ölçüsü : Ø17 Aşık Diş Çapı : M14X1,5 Rotil Gövde Çapı : Ø42	4G0407689A, 4G0407689C 8W0407689B
	<b>AU2019</b> ROTBAŞI SAĞ M16X1,5 RHT	Ağırlık : 0,78 kg / 1.720 lb Uzunluk : 209 mm / 8.23 inch Gövde Diş Çapı : M16X1,5 Aşık Diş Çapı : M12X1,5 Aşık Konik Çapı : Ø14,7	4G0423812A
	<b>AU2020</b> ROTBAŞI SOL M16X1,5 RHT	Ağırlık : 0,78 kg / 1.720 lb Uzunluk : 209 mm / 8.23 inch Gövde Diş Çapı : M16X1,5 Aşık Diş Çapı : M12X1,5 Aşık Konik Çapı : Ø14,7	4G0423811A
	<b>AU4023</b> Z ROT SOL VE SAĞ PLASTİK RB2947	Ağırlık : 0,117 kg / 0.258 lb Malzeme Türü : Plastik Uzunluk : 62 mm / 2.44 inch	8K0505465E, 8K0505465G
	<b>AU4024</b> Z ROT ARKA SAĞ	Ağırlık : 0,508 kg / 1.120 lb Uzunluk : 282,5 mm / 11.12 inch	8K0501530K, 8K0501530N









\* Bu sayfada ve katalogdaki tüm araçların adları, markaları, modelleri, sembolleri, logoları, orijinal numaraları (oe) ve diğer üçüncü parti numaraları sadece referans amaçlı kullanılmaktadır.

**A7 Sportback**
**4GA, AGF**
**2010 - 2018**

Resim	Ürün Kodu ve Açıklaması	Detay	OEM
	<b>AU4025</b> Z ROT ARKA SOL	Ağırlık : 0,508 kg / 1.120 lb Uzunluk : 282,5 mm / 11.12 inch	8K0501529K, 8K0501529N
	<b>AU4026</b> Z ROT ÖN DENGE ROTU 170 RB2944	Ağırlık : 0,185 kg / 0.408 lb Malzeme Türü : Denge Rotu Uzunluk : 170 mm / 6.69 inch	8K0411317C, 8K0411317D 8K0411317E
	<b>AU4029</b> Z ROT ÖN	Ağırlık : 0,138 kg / 0.304 lb Uzunluk : 170 mm / 6.69 inch	8K0411317D, 8K0411317E
	<b>AU4031</b> Z ROT ÖN ALÜMİNYUM L=170	Ağırlık : 0,201 kg / 0.443 lb Malzeme Türü : Alüminyum Uzunluk : 170 mm / 6.69 inch	4G0411317A, 4G0411317C 4M0411317
	<b>AU5041</b> SALINCAK ÖN ALT SAĞ	Malzeme Türü : Alüminyum	4G0407694D, 4G0407694F 4G0407694H, 4G0407694J 4G0407694L
	<b>AU5042</b> SALINCAK ÖN ALT SOL	Malzeme Türü : Alüminyum	4G0407693D, 4G0407693F 4G0407693H, 4G0407693J 4G0407693L
	<b>AU5062</b> SALINCAK ÖN ALT SAĞ	Ağırlık : 1,3 kg / 2.866 lb Malzeme Türü : Alüminyum	8K0407152B, 8K0407152C 8K0407152D, 8K0407152E
	<b>AU5063</b> SALINCAK ÖN ALT SOL	Ağırlık : 1,3 kg / 2.866 lb Malzeme Türü : Alüminyum	8K0407151D
	<b>AU11036</b> SALINCAK VE DENGE KOLU BURCU ÖN SOL VE SAĞ	Şasi (Ön / Arka) : ÖN Yön : Sol Ve Sağ Ağırlık : 0,25 kg / 0.551 lb Not : DENGE KOLU BURCU	4H0407515, 8D0407515A 8K0407515, 8R0407515
	<b>AU11054</b> SALINCAK VE DENGE KOLU BURCU SOL VE SAĞ	Yön : Sol Ve Sağ Ağırlık : 0,172 kg / 0.379 lb Not : SALINCAK BURCU	8K0407151B*, 8K0407151B 8K0407152B*
	<b>AU11060</b> SALINCAK VE DENGE KOLU BURCU ÖN ALT SOL VE SAĞ	Şasi (Ön / Arka) : ÖN Yön : Alt Sol Ve Sağ Ağırlık : 0,248 kg / 0.547 lb	4G0407183, 4G0407183A 4H0407183, 4H0407183B 4H0407183C





\* Bu sayfada ve katalogdaki tüm araçların adları, markaları, modelleri, sembolleri, logoları, orjinal numaraları (oe) ve diğer üçüncü parti numaraları sadece referans amaçlı kullanılmaktadır.

**A7 Sportback**
**4GA, AGF**
**2010 - 2018**

Resim	Ürün Kodu ve Açıklaması	Detay	OEM
	<b>AU11025</b> Z-ROT BURCU ARKA SOL VE SAĞ	Şasi (Ön / Arka) : ARKA Yön : Sol Ve Sağ Ağırlık : 0.032 kg / 0.071 lb Uzunluk : AU4023 mm / 0.00 inch	8K0505465E*, 8K0505465G*
	<b>AU12049</b> VİRAJ DEMİR LASTİĞİ	Şasi (Ön / Arka) : ÖN Ağırlık : 0,060 kg / 0.132 lb	8K0411327B
	<b>AU12049K</b> VİRAJ DEMİR LASTİĞİ	Şasi (Ön / Arka) : ÖN Ağırlık : 0,120 kg / 0.265 lb	8K0411327B
	<b>AU12050</b> VİRAJ DEMİR LASTİĞİ	Şasi (Ön / Arka) : ÖN Ağırlık : 0,059 kg / 0.130 lb	8K0411327A
	<b>AU12050K</b> VİRAJ DEMİR LASTİĞİ	Şasi (Ön / Arka) : ÖN Ağırlık : 0,118 kg / 0.260 lb	8K0411327A
	<b>AU12031</b> MOTOR TAKOZU ÖN SOL	Şasi (Ön / Arka) : ÖN Yön : Sol Ağırlık : 1,575 kg / 3.472 lb	4G0199381, 4G0199381KT 4G0199381LC, 4G0199381LG 4G0199381LH, 4G0199381NT
	<b>AU12046</b> ŞANZIMAN TAKOZU	Ağırlık : 1,156 kg / 2.549 lb	4G0399153T, 4M0399153AE
	<b>AU12048</b> ŞANZIMAN TAKOZU ARKA ORTA	Şasi (Ön / Arka) : ARKA Yön : Orta Ağırlık : 0,641 kg / 1.413 lb	8K0399151BF, 8K0399151CD 8K0399151DB
	<b>AU12038</b> SÜSPANSİYON TAKOZU ARKA	Şasi (Ön / Arka) : ARKA Ağırlık : 0,095 kg / 0.209 lb	8K0512131B, 8T0513028AB 8T0513028R, 8T0513029 8T0513029A
	<b>AU12039</b> SÜSPANSİYON TAKOZU ÖN	Şasi (Ön / Arka) : ÖN Ağırlık : 0,075 kg / 0.165 lb	8K0412131E
	<b>AU12040</b> SÜSPANSİYON TAKOZU ÖN	Şasi (Ön / Arka) : ÖN Ağırlık : 0,075 kg / 0.165 lb	8K0412131F

\* Bu sayfada ve katalogdaki tüm araçların adları, markaları, modelleri, sembolleri, logoları, orjinal numaraları (oe) ve diğer üçüncü parti numaraları sadece referans amaçlı kullanılmaktadır.

**A8 4D2, 4D8 1994 - 2002**

Resim	Ürün Kodu ve Açıklaması	Detay	OEM
	<b>AU2214</b> ROTBAŞI ÖN SAĞ - SOL RB2214	Ağırlık : 0,594 kg / 1.310 lb Uzunluk : 156 mm / 6.14 inch Gövde Diş Çapı : M14X1,5 Aşık Diş Çapı : M8X1,25 Aşık Konik Çapı : Ø17,5	4B0419811B, 4B0419811C 4B0419811E, 4B0419811F 4D0419811A, 4D0419811B 4D0419811G, 4D0419811H 4F0419811E, 4F0498811
	<b>AU2214A</b> ROTBAŞI SAĞ-SOL (KOMPLE DEMİR) RB2225	Ağırlık : 0,597 kg / 1.316 lb Uzunluk : 156 mm / 6.14 inch Gövde Diş Çapı : M14X1,5 Aşık Diş Çapı : M8X1,25 Aşık Konik Çapı : Ø17,4	4B0419811B, 4D0419811A 4D0419811J, 8E0419811B 8E0419811C
	<b>AU2217</b> ROTBAŞI SAĞ-SOL RB2217	Ağırlık : 0,414 kg / 0.913 lb Uzunluk : 155 mm / 6.10 inch Gövde Diş Çapı : M14X1,5 Aşık Diş Çapı : M8X1,25 Aşık Konik Çapı : Ø17,5	4B0419811G, 4D0419811J 4F0419811C, 4F0419811D 4F0498811, 4F0498811A 8E0419811
	<b>AU3002</b> ROTMİLİ SAĞ-SOL 144 MM RB2814	Ağırlık : 0,445 kg / 0.981 lb Uzunluk : 130 mm / 5.12 inch Gövde Diş Çapı : M16X1,5 Aşık Diş Çapı : M14X1,5	4B0422821, 4D0422821 4D0422821A

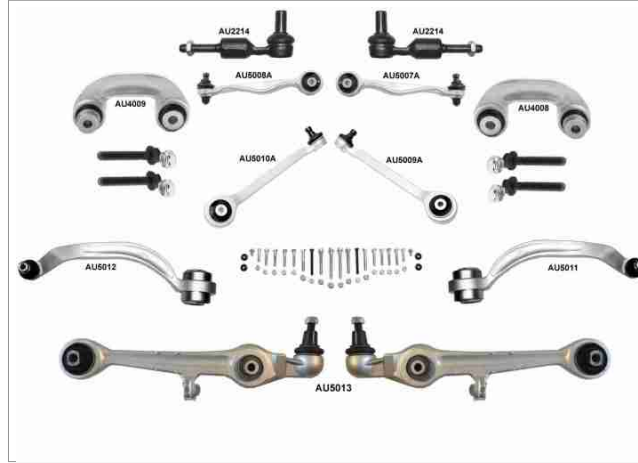
**AU8001 / Süspansiyon Kit Ön**
**A8**
**4D2, 4D8**
**1994 - 2002**

**OEM**

8D0498998, 8D0498998-S1

**Kit Parçaları**

Resim	Ürün Kodu / Adı	OEM	OEM	Ürün Kodu / Adı	Resim
	<b>AU2214</b> Rotbaşı Ön Sağ - Sol Rb2214	4B0419811B, 4B0419811C 4B0419811E, 4B0419811F 4D0419811A, 4D0419811B 4D0419811G, 4D0419811H 4F0419811E, 4F0498811	4B0419811B, 4B0419811C 4B0419811E, 4B0419811F 4D0419811A, 4D0419811B 4D0419811G, 4D0419811H 4F0419811E, 4F0498811	<b>AU2214</b> Rotbaşı Ön Sağ - Sol Rb2214	
	<b>AU4008</b> Z Rot Ön Sağ Alüminyum 90 Rb2921	8D0407318D, 8D0411318D	8D0407317D, 8D0411317D	<b>AU4009</b> Z Rot Ön Sol Alüminyum 90 Rb2920	
	<b>AU5007A</b> Salıncak Ön Üst Sağ Rb2629	4D0407510B, 4D0407510D 4D0407510F, 4D0407510G 4D0407510H, 4D0407510J 4D0407510K, 8D0407510A 8D0407510C, 8D0407510E	4D0407509F, 4D0407509G 4D0407509J, 4D0407509K 8D0407509C, 8D0407509E 8E0407509A	<b>AU5008A</b> Salıncak Ön Üst Sol Rb2628	
	<b>AU5009A</b> Salıncak Ön Üst Sağ Rb2635	8D0407506A, 8D0407506B 8E0407506A, 8E0407506P	8D0407505A, 8E0407505A 8E0407505P	<b>AU5010A</b> Salıncak Ön Üst Sol Rb2634	
	<b>AU5011</b> Salıncak Ön Alt Sağ Rb2637	4D0407694AC, 4D0407694AD 4D0407694E, 4D0407694H 4D0407694K, 4D0407694M 4D0407694N, 8E0407694 8E0407694AG, 8E0407694E	4D0407693AC, 4D0407693AD 4D0407693E, 4D0407693H 4D0407693K, 4D0407693M 4D0407693N, 8E0407693 8E0407693AG, 8E0407693E	<b>AU5012</b> Salıncak Ön Alt Sol Rb2636	
	<b>AU5013</b> Salıncak Ön Alt Ön Taraf Sol Ve Sağ Alüminyum Rb2616	4B3407151C, 4B3407151E 4D0407151G, 4D0407151H 4D0407151J	4B3407151C, 4B3407151E 4D0407151G, 4D0407151H 4D0407151J	<b>AU5013</b> Salıncak Ön Alt Ön Taraf Sol Ve Sağ Alüminyum Rb2616	

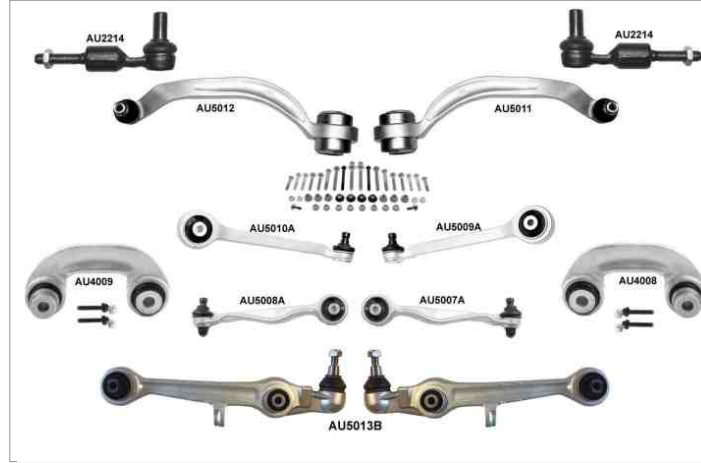
## AU8002 / Süspansiyon Kit Ön

**A8**
**4D2, 4D8**
**1994 - 2002**

**OEM**



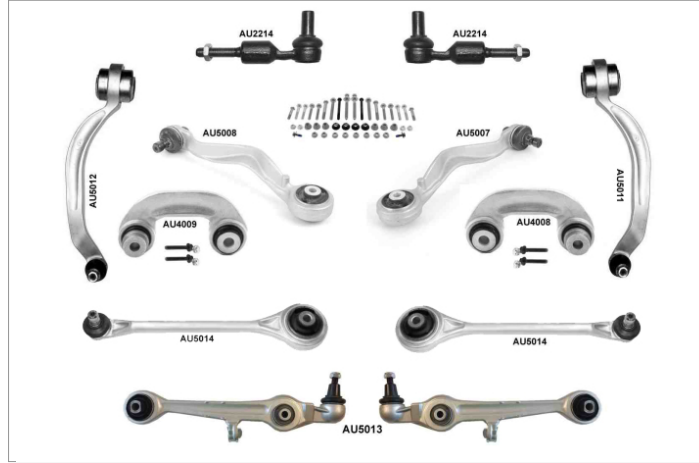

4B3498998, 4B3498998-S1, 8B0498998S1

### Kit Parçaları

Resim	Ürün Kodu / Adı	OEM	OEM	Ürün Kodu / Adı	Resim
	<b>AU2214</b> Rotbaşı Ön Sağ - Sol Rb2214	4B0419811B, 4B0419811C 4B0419811E, 4B0419811F 4D0419811A, 4D0419811B 4D0419811G, 4D0419811H 4F0419811E, 4F0498811	4B0419811B, 4B0419811C 4B0419811E, 4B0419811F 4D0419811A, 4D0419811B 4D0419811G, 4D0419811H 4F0419811E, 4F0498811	<b>AU2214</b> Rotbaşı Ön Sağ - Sol Rb2214	
	<b>AU4008</b> Z Rot Ön Sağ Alüminyum 90 Rb2921	8D0407318D, 8D0411318D	8D0407317D, 8D0411317D	<b>AU4009</b> Z Rot Ön Sol Alüminyum 90 Rb2920	
	<b>AU5007A</b> Salıncak Ön Üst Sağ Rb2629	4D0407510B, 4D0407510D 4D0407510F, 4D0407510G 4D0407510H, 4D0407510J 4D0407510K, 8D0407510A 8D0407510C, 8D0407510E	4D0407509F, 4D0407509G 4D0407509J, 4D0407509K 8D0407509C, 8D0407509E 8E0407509A	<b>AU5008A</b> Salıncak Ön Üst Sol Rb2628	
	<b>AU5009A</b> Salıncak Ön Üst Sağ Rb2635	8D0407506A, 8D0407506B 8E0407506A, 8E0407506P	8D0407505A, 8E0407505A 8E0407505P	<b>AU5010A</b> Salıncak Ön Üst Sol Rb2634	
	<b>AU5011</b> Salıncak Ön Alt Sağ Rb2637	4D0407694AC, 4D0407694AD 4D0407694E, 4D0407694H 4D0407694K, 4D0407694M 4D0407694N, 8E0407694 8E0407694AG, 8E0407694E	4D0407693AC, 4D0407693AD 4D0407693E, 4D0407693H 4D0407693K, 4D0407693M 4D0407693N, 8E0407693 8E0407693AG, 8E0407693E	<b>AU5012</b> Salıncak Ön Alt Sol Rb2636	
	<b>AU5013B</b> Salıncak Ön Alt Ön Taraf Sol Ve Sağ Alüminyum Rb2641	4B3407151C, 4B3407151K	4B3407151C, 4B3407151K	<b>AU5013B</b> Salıncak Ön Alt Ön Taraf Sol Ve Sağ Alüminyum Rb2641	



**AU8004 / Süspansiyon Kit Ön**
**A8**
**4D2, 4D8**
**1994 - 2002**

**Kit Parçaları**











Resim	Ürün Kodu / Adı	OEM	OEM	Ürün Kodu / Adı	Resim
	<b>AU2214</b> Rotbaşı Ön Sağ - Sol Rb2214	4B0419811B, 4B0419811C 4B0419811E, 4B0419811F 4D0419811A, 4D0419811B 4D0419811G, 4D0419811H 4F0419811E, 4F0498811	4B0419811B, 4B0419811C 4B0419811E, 4B0419811F 4D0419811A, 4D0419811B 4D0419811G, 4D0419811H 4F0419811E, 4F0498811	<b>AU2214</b> Rotbaşı Ön Sağ - Sol Rb2214	
	<b>AU4008</b> Z Rot Ön Sağ Alüminyum 90 Rb2921	8D0407318D, 8D0411318D	8D0407317D, 8D0411317D	<b>AU4009</b> Z Rot Ön Sol Alüminyum 90 Rb2920	
	<b>AU5007</b> Salıncak Ön Üst Sağ	4D0407510B, 4D0407510D	4D0407509B, 4D0407509D	<b>AU5008</b> Salıncak Ön Üst Sol	
	<b>AU5011</b> Salıncak Ön Alt Sağ Rb2637	4D0407694AC, 4D0407694AD 4D0407694E, 4D0407694H 4D0407694K, 4D0407694M 4D0407694N, 8E0407694 8E0407694AG, 8E0407694E	4D0407693AC, 4D0407693AD 4D0407693E, 4D0407693H 4D0407693K, 4D0407693M 4D0407693N, 8E0407693 8E0407693AG, 8E0407693E	<b>AU5012</b> Salıncak Ön Alt Sol Rb2636	
	<b>AU5013</b> Salıncak Ön Alt Ön Taraf Sol Ve Sağ Alüminyum Rb2616	4B3407151C, 4B3407151E 4D0407151G, 4D0407151H 4D0407151J	4B3407151C, 4B3407151E 4D0407151G, 4D0407151H 4D0407151J	<b>AU5013</b> Salıncak Ön Alt Ön Taraf Sol Ve Sağ Alüminyum Rb2616	
	<b>AU5014</b> Salıncak Arka Rb2625	4D0.407.505D, 4D0.407.505F 4D0407505A, 4D0407505B 4D0407505D, 4D0407505F 4D0407505H			

**A8 4D2, 4D8 1994 - 2002**

Resim	Ürün Kodu ve Açıklaması	Detay	OEM
	<b>AU22143002</b> ROT TAKIMI ÖN AKS RB288115	Ağırlık : 1,043 kg / 2.299 lb Rotbaşı : AU2214 Rotmili : AU3002	1J0422812A, 4B0419801B 4B0419801E, 4B0419801M 4D0419801B, 4D0419801C 4D0419801D, 4D0419801L
	<b>AU2214A3002</b> ROT TAKIMI ÖN AKS RB288136	Ağırlık : 1,026 kg / 2.262 lb Rotbaşı : AU2214 Rotmili : AU3002	4B0419801G, 4B0419801N 4D0419801Q, 8E0419801B
	<b>AU22173002</b> ROT TAKIMI ÖN	Ağırlık : 0,916 kg / 2.019 lb Rotbaşı : AU2217 Rotmili : AU3002	4B0419801E, 4B0419801G 4F0419811D, 4F0422821D 4F0498811A, 4F0498811C 8E0419801B, 8E0419811
	<b>AU4007</b> Z ROT ÖN SAĞ-SOL ALÜMİNYUM 90 RB2942	Ağırlık : 0,378 kg / 0.833 lb Malzeme Türü : Alüminyum Uzunluk : 86 mm / 3.39 inch Aşık Diş Çapı : M10X1,5	4D0411317G, 4D0411317J 4D0411317K
	<b>AU4010</b> Z ROT ÖN SAĞ-SOL ALÜMİNYUM 90 RB2912	Ağırlık : 0,325 kg / 0.717 lb Malzeme Türü : Alüminyum Uzunluk : 90 mm / 3.54 inch	4D0411317J, 4D0411317K
	<b>AU4011</b> Z ROT ARKA SAĞ - SOL RB2918	Ağırlık : 0,283 kg / 0.624 lb Uzunluk : 120 mm / 4.72 inch Aşık Diş Çapı : M10X1,5	4D0505465D
	<b>AU4012</b> Z ROT SAĞ RB2916	Ağırlık : 0,234 kg / 0.516 lb Uzunluk : 61,5 mm / 2.42 inch	4D0505548C, 4E0505548 4E0505548A, 4E0505548L
	<b>AU4013</b> Z ROT SOL RB2917	Ağırlık : 0,237 kg / 0.522 lb Uzunluk : 61,5 mm / 2.42 inch	4D0505547C, 4E0505547 4E0505547A, 4E0505547L
	<b>AU5007</b> SALINCAK ÖN ÜST SAĞ	Malzeme Türü : Alüminyum	4D0407510B, 4D0407510D
	<b>AU5007A</b> SALINCAK ÖN ÜST SAĞ RB2629	Ağırlık : 0,460 kg / 1.014 lb Malzeme Türü : Alüminyum	4D0407510B, 4D0407510D 4D0407510F, 4D0407510G 4D0407510H, 4D0407510J 4D0407510K, 8D0407510A 8D0407510C, 8D0407510E
	<b>AU5008</b> SALINCAK ÖN ÜST SOL	Malzeme Türü : Alüminyum	4D0407509B, 4D0407509D

\* Bu sayfada ve katalogdaki tüm araçların adları, markaları, modelleri, sembolleri, logoları, orjinal numaraları (oe) ve diğer üçüncü parti numaraları sadece referans amaçlı kullanılmaktadır.











**A8 4D2, 4D8 1994 - 2002**

Resim	Ürün Kodu ve Açıklaması	Detay	OEM
	<b>AU5008A</b> SALINCAK ÖN ÜST SOL RB2628	Ağırlık : 0,460 kg / 1.014 lb Malzeme Türü : Alüminyum	4D0407509F, 4D0407509G 4D0407509J, 4D0407509K 8D0407509C, 8D0407509E 8E0407509A
	<b>AU5009</b> SALINCAK ÖN ÜST SAĞ RB2630	Malzeme Türü : Alüminyum	8D0407506B, 8D0407506F 8D0407506H, 8D0407506K
	<b>AU5009A</b> SALINCAK ÖN ÜST SAĞ RB2635	Ağırlık : 0,488 kg / 1.076 lb Malzeme Türü : Alüminyum	8D0407506A, 8D0407506B 8E0407506A, 8E0407506P
	<b>AU5010</b> SALINCAK ÖN ÜST SOL RB2631	Malzeme Türü : Alüminyum	8D0407505B, 8D0407505F 8D0407505H, 8D0407505K
	<b>AU5010A</b> SALINCAK ÖN ÜST SOL RB2634	Ağırlık : 0,488 kg / 1.076 lb Malzeme Türü : Alüminyum	8D0407505A, 8E0407505A 8E0407505P
	<b>AU5011</b> SALINCAK ÖN ALT SAĞ RB2637	Ağırlık : 1,750 kg / 3.858 lb Malzeme Türü : Alüminyum	4D0407694AC, 4D0407694AD 4D0407694E, 4D0407694H 4D0407694K, 4D0407694M 4D0407694N, 8E0407694 8E0407694AG, 8E0407694E
	<b>AU5012</b> SALINCAK ÖN ALT SOL RB2636	Ağırlık : 1,800 kg / 3.968 lb Malzeme Türü : Alüminyum	4D0407693AC, 4D0407693AD 4D0407693E, 4D0407693H 4D0407693K, 4D0407693M 4D0407693N, 8E0407693 8E0407693AG, 8E0407693E
	<b>AU5013</b> SALINCAK ÖN ALT ÖN TARAF SOL VE SAĞ ALÜMİNYUM RB2616	Ağırlık : 1,520 kg / 3.351 lb Malzeme Türü : Alüminyum	4B3407151C, 4B3407151E 4D0407151G, 4D0407151H 4D0407151J
	<b>AU5013A</b> SALINCAK ÖN ALT ÖN TARAF SOL VE SAĞ ALÜMİNYUM RB2648	Ağırlık : 1,504 kg / 3.316 lb Malzeme Türü : Alüminyum	8E0407151E, 8E0407151K 8E0407151L, 8E0407151M 8E0407151N, 8E0407151R 8E0407155J
	<b>AU5013B</b> SALINCAK ÖN ALT ÖN TARAF SOL VE SAĞ ALÜMİNYUM RB2641	Ağırlık : 1,500 kg / 3.307 lb Malzeme Türü : Alüminyum	4B3407151C, 4B3407151K
	<b>AU5014</b> SALINCAK ARKA RB2625	Malzeme Türü : Alüminyum	4D0.407.505D, 4D0.407.505F 4D0407505A, 4D0407505B 4D0407505D, 4D0407505F 4D0407505H

\* Bu sayfada ve katalogdaki tüm araçların adları, markaları, modelleri, sembolleri, logoları, orjinal numaraları (oe) ve diğer üçüncü parti numaraları sadece referans amaçlı kullanılmaktadır.

A8	4D2, 4D8	1994 - 2002	
Resim	Ürün Kodu ve Açıklaması	Detay	OEM
	<b>AU9015</b> SALINCAK ARKA	Ağırlık : 0,650 kg / 1.433 lb Malzeme Türü : Alüminyum	4D0501529A, 4D0501529E 4D0501529F
	<b>AU11003</b> SALINCAK VE DENGE KOLU BURCU ÖN ÜST SOL VE SAĞ B22115	Şasi (Ön / Arka) : ÖN Yön : Üst Sol Ve Sağ Ağırlık : 0,075 kg / 0.165 lb	4B0407515, 4B0407515A 4D0407515C*, 4D0407515C
	<b>AU11004</b> SALINCAK VE DENGE KOLU BURCU ÖN ORTA SOL VE SAĞ B22112	Şasi (Ön / Arka) : ÖN Yön : Orta Sol Ve Sağ Ağırlık : 0,112 kg / 0.247 lb	4D0407181F, 4D0407181H
	<b>AU11006</b> SALINCAK VE DENGE KOLU BURCU ÖN SOL VE SAĞ	Şasi (Ön / Arka) : ÖN Yön : Sol Ve Sağ Ağırlık : 0,225 kg / 0.496 lb	4D0407182E, 4D0407182G 8E0407182A, 8E0407182E
	<b>AU11007</b> SALINCAK VE DENGE KOLU BURCU ÖN ALT SOL VE SAĞ	Şasi (Ön / Arka) : ÖN Yön : Alt Sol Ve Sağ Ağırlık : 0,59 kg / 1.301 lb	4D0407183AB, 4D0407183AC 4D0407183D, 4D0407183M 4D0407183N, 4D0407183P 4D0407183S
	<b>AU11012</b> SALINCAK VE DENGE KOLU BURCU ÖN SOL VE SAĞ B22116	Şasi (Ön / Arka) : ÖN Yön : Sol Ve Sağ Ağırlık : 0,188 kg / 0.414 lb	4D0407516A, 4D0407516C
	<b>AU11033</b> SALINCAK VE DENGE KOLU BURCU ÖN ALT SOL VE SAĞ B22135	Şasi (Ön / Arka) : ÖN Yön : Alt Sol Ve Sağ Ağırlık : 0,072 kg / 0.159 lb	8E0407181B, 8E0407181C 8E0407181D
	<b>VW11052</b> SALINCAK VE DENGE KOLU BURCU ALT SOL VE SAĞ B22130	Yön : Alt Sol Ve Sağ Ağırlık : 0,523 kg / 1.153 lb	4D0407183M, 4D0407183N 4D0407183P, 4D0407183Q 4E0407183M
	<b>AU11079</b> Z-ROT BURCU ARKA	Şasi (Ön / Arka) : ARKA Ağırlık : 0,055 kg / 0.121 lb Uzunluk : AU4012 mm / 0.00 inch Aşık Diş Çapı : AU4013	4D0505547C*, 4E0505547L*
	<b>AU11091</b> ROTMİLİ BURCU VE LASTİĞİ		4B0419811E*, 4B0419811F* 4D0419811A*, 4D0419811B* 4F0419811B*, 4F0419811E* 4F0498811*, 8E0419811B*
	<b>AU12029</b> ROTMİLİ BURCU VE LASTİĞİ ÖN	Şasi (Ön / Arka) : ÖN	171419804*, 171419804A* 175419804*

\* Bu sayfada ve katalogdaki tüm araçların adları, markaları, modelleri, sembolleri, logoları, orjinal numaraları (oe) ve diğer üçüncü parti numaraları sadece referans amaçlı kullanılmaktadır.

A8	4D2, 4D8	1994 - 2002	
Resim	Ürün Kodu ve Açıklaması	Detay	OEM
	<b>AU12029K</b> ROTMİLİ BURCU VE LASTİĞİ ÖN	Şasi (Ön / Arka) : ÖN	171419804*, 171419804A* 175419804*
	<b>AU12005</b> VİRAJ DEMİR LASTİĞİ SOL VE SAĞ RUBBER	Şasi (Ön / Arka) : ÖN Yön : Sol Ve Sağ Ağırlık : 0.06 kg / 0.132 lb Malzeme Türü : Rubber	4D0411327F, 4D0411327H
	<b>AU12005K</b> VİRAJ DEMİR LASTİĞİ SOL VE SAĞ RUBBER	Şasi (Ön / Arka) : ÖN Yön : Sol Ve Sağ Ağırlık : 0.12 kg / 0.265 lb Malzeme Türü : Rubber	4D0411327F, 4D0411327H
	<b>VW12087</b> VİRAJ DEMİR LASTİĞİ SOL VE SAĞ RUBBER	Şasi (Ön / Arka) : ÖN Yön : Sol Ve Sağ Ağırlık : 0.059 kg / 0.130 lb Malzeme Türü : Rubber Not : VİRAJ LASTİĞİ	4D0411327E, 4D0411327G
	<b>VW12087K</b> VİRAJ DEMİR LASTİĞİ SOL VE SAĞ RUBBER	Şasi (Ön / Arka) : ÖN Yön : Sol Ve Sağ Ağırlık : 0.118 kg / 0.260 lb Malzeme Türü : Rubber	4D0411327E*, 4D0411327G*
	<b>VW12022</b> AMORTİSÖR TAKOZU SOL VE SAĞ AMORTİSÖR TAKOZU	Yön : Sol Ve Sağ Ağırlık : 0.44 kg / 0.970 lb Not : AMORTİSÖR TAKOZU	4D0412377F
	<b>AU12006</b> SÜSPANSİYON TAKOZU ARKA SOL VE SAĞ	Şasi (Ön / Arka) : ARKA Yön : Sol Ve Sağ Ağırlık : 0.55 kg / 1.213 lb	1J0 512 131 B, 1J0 513 025 Q 1J0512131B, 1J0513025Q
	<b>VW13001</b> DİREKSİYON KÖRÜĞÜ	Ağırlık : 0.065 kg / 0.143 lb	4D0419831
	<b>VW13009</b> DİREKSİYON KÖRÜĞÜ	Ağırlık : 0.19 kg / 0.419 lb	8D0419831J, 8D0419831K
	<b>VW14001</b> AKS KÖRÜĞÜ +KELEPÇE+YAĞ. DIŞ	Ağırlık : 0.14 kg / 0.309 lb	441 407 203A, 441407203A

A8	4E	2002 - 2010	
Resim	Ürün Kodu ve Açıklaması	Detay	OEM
	<b>AU1020</b> ROTİL ARKA	Ağırlık : 0,141 kg / 0.311 lb	4E0501529C, 4E0501529D* 4E0501529D, 4E0501529G* 4E0501529G
	<b>AU2218</b> ROTBAŞI ÖN SAĞ - SOL RB2218	Ağırlık : 0,654 kg / 1.442 lb Uzunluk : 161 mm / 6.34 inch Gövde Diş Çapı : M16X1,5 Aşık Diş Çapı : M8X1,25 Aşık Konik Çapı : Ø23	4E0419811B, 4E0419811C 4E0419811D, 4E0419811E
	<b>AU3006</b> ROTMİLİ SAĞ-SOL RB2839	Ağırlık : 0,455 kg / 1.003 lb Uzunluk : 127 mm / 5.00 inch Gövde Diş Çapı : M16X1,5 Aşık Diş Çapı : M16X1,5	4E0419801C, 4E0419801D 4E0419821, 4E0419821C 4E0419821D
	<b>AU20183006</b> ROT TAKIMI ÖN AKS RB288133	Ağırlık : 1,102 kg / 2.429 lb Rotbaşı : AU2018 Rotmilî : AU3006	4E0419801C, 4E0419801D
	<b>AU4012</b> Z ROT SAĞ RB2916	Ağırlık : 0,234 kg / 0.516 lb Uzunluk : 61,5 mm / 2.42 inch	4D0505548C, 4E0505548 4E0505548A, 4E0505548L
	<b>AU4013</b> Z ROT SOL RB2917	Ağırlık : 0,237 kg / 0.522 lb Uzunluk : 61,5 mm / 2.42 inch	4D0505547C, 4E0505547 4E0505547A, 4E0505547L
	<b>AU4019</b> RB2930 RIW Z ROT ÖN SAĞ-SOL	Ağırlık : 0,353 kg / 0.778 lb Malzeme Türü : Alüminyum Uzunluk : 110 mm / 4.33 inch	, 4E0411317C 4E0411317D, 4E0411317E
	<b>AU4036</b> Z ROT SOL VE SAĞ METAL	Ağırlık : 0,227 kg / 0.500 lb Malzeme Türü : Metal Uzunluk : 94 mm / 3.70 inch	4E0505465G
	<b>AU5017</b> SALINCAK ÖN ÜST SAĞ RB2651	Malzeme Türü : Alüminyum	4E0407510B
	<b>AU5018</b> SALINCAK ÖN ÜST SOL RB2650	Malzeme Türü : Alüminyum	4E0407509B
	<b>AU5019</b> SALINCAK ÖN ÜST ÖNDEN SAĞ RB2643	Malzeme Türü : Alüminyum	4E0407506B

\* Bu sayfada ve katalogdaki tüm araçların adları, markaları, modelleri, sembolleri, logoları, orjinal numaraları (oe) ve diğer üçüncü parti numaraları sadece referans amaçlı kullanılmaktadır.

**A8**
**4E**
**2002 - 2010**

Resim	Ürün Kodu ve Açıklaması	Detay	OEM
	<b>AU5020</b> SALINCAK ÖN ÜST ÖNDEN SOL RB2642	Malzeme Türü : Alüminyum	4E0407505B
	<b>AU5024</b> SALINCAK ÖN ALT SAĞ RB2645	Malzeme Türü : Alüminyum	4E0407694C, 4E0407694F 4E0407696B
	<b>AU5025</b> SALINCAK ÖN ALT SOL RB2644	Malzeme Türü : Alüminyum	4E0407693C, 4E0407693F 4E0407695B
	<b>AU5026</b> SALINCAK ÖN ALT RB2649	Malzeme Türü : Alüminyum	4E0407151G, 4E0407151L 4E0407155C
	<b>AU5055</b> SALINCAK ARKA ALT	Malzeme Türü : Alüminyum	4E0501529D, 4E0501529G
	<b>AU11032</b> SALINCAK VE DENGE KOLU BURCU ÖN SOL VE SAĞ	Şasi (Ön / Arka) : ÖN Yön : Sol Ve Sağ Ağırlık : 0,17 kg / 0.375 lb Not : DENGE KOLU BURCU	4D0407183L, 4F0407183A 4F0407183B, 4F0407183E
	<b>AU11036</b> SALINCAK VE DENGE KOLU BURCU ÖN SOL VE SAĞ	Şasi (Ön / Arka) : ÖN Yön : Sol Ve Sağ Ağırlık : 0,25 kg / 0.551 lb Not : DENGE KOLU BURCU	4H0407515, 8D0407515A 8K0407515, 8R0407515
	<b>AU11042</b> SALINCAK VE DENGE KOLU BURCU ALT SOL VE SAĞ	Yön : Alt Sol Ve Sağ Ağırlık : 0,16 kg / 0.353 lb	4E0407182C
	<b>AU11043</b> SALINCAK VE DENGE KOLU BURCU ÖN ALT ORTA SOL VE SAĞ B22137	Şasi (Ön / Arka) : ÖN Yön : Alt Orta Sol Ve Sağ Ağırlık : 0,1 kg / 0.220 lb	4E0407181B
	<b>AU11044</b> SALINCAK VE DENGE KOLU BURCU ALT ORTA SOL VE SAĞ	Yön : Alt Orta Sol Ve Sağ Ağırlık : 0,1 kg / 0.220 lb	4E0407183B
	<b>AU11045</b> SALINCAK VE DENGE KOLU BURCU ÜST SOL VE SAĞ	Yön : Üst Sol Ve Sağ Ağırlık : 0,1 kg / 0.220 lb	4E0407515D, 8D0407515B 8K0407515

\* Bu sayfada ve katalogdaki tüm araçların adları, markaları, modelleri, sembolleri, logoları, orjinal numaraları (oe) ve diğer üçüncü parti numaraları sadece referans amaçlı kullanılmaktadır.

**A8 4E 2002 - 2010**









Resim	Ürün Kodu ve Açıklaması	Detay	OEM
	<b>AU11059</b> SALINCAK VE DENG KOLU BURCU ARKA ALT SOL VE SAĞ	Şasi (Ön / Arka) : ARKA Yön : Alt Sol Ve Sağ Ağırlık : 0,127 kg / 0.280 lb	4E0501529D*, 4E0501529D-P 4E0501529G*, 4E0501529G-P Part of 4E0501529D, Part of 4E0501529G
	<b>AU11079</b> Z-ROT BURCU ARKA	Şasi (Ön / Arka) : ARKA Ağırlık : 0,055 kg / 0.121 lb Uzunluk : AU4012 mm / 0.00 inch Aşık Diş Çapı : AU4013	4D0505547C*, 4E0505547L*
	<b>VW12022</b> AMORTİSÖR TAKOZU SOL VE SAĞ AMORTİSÖR TAKOZU	Yön : Sol Ve Sağ Ağırlık : 0.44 kg / 0.970 lb Not : AMORTİSÖR TAKOZU	4D0412377F
	<b>VW14011</b> AKS KÖRÜĞÜ +KELEPÇE+YAĞ. İÇ	Ağırlık : 0.236 kg / 0.520 lb	1K0498201D

**A8 4H 2010 - 2018**

Resim	Ürün Kodu ve Açıklaması	Detay	OEM
	<b>AU1021</b> ROTİL ALT <<ÖZELLİK>>	Ağırlık : 0,648 kg / 1.429 lb Konik Ölçüsü : Ø18,5 Aşık Diş Çapı : M14X1,5	4H0 407 689, 4H0407689 4H0407689A
	<b>AU2021</b> ROTBAŞI SAĞ M16X1,5 RHT	Ağırlık : 0,878 kg / 1.936 lb	4H0422818A
	<b>AU2022</b> ROTBAŞI SOL M16X1,5 RHT	Ağırlık : 0,878 kg / 1.936 lb	4H0422817A
	<b>AU3009</b> ROTMİLİ SAĞ-SOL M16X1,5 L=236	Ağırlık : 0,617 kg / 1.360 lb Uzunluk : 236 mm / 9.29 inch Gövde Diş Çapı : M16X1,5 Aşık Diş Çapı : M16X1,5	4G0423810A
	<b>AU3010</b> ROTMİLİ SAĞ-SOL M16X1,5 L=226	Ağırlık : 0,608 kg / 1.340 lb Uzunluk : 226 mm / 8.90 inch Gövde Diş Çapı : M16X1,5 Aşık Diş Çapı : M16X1,5	4H0422810, 4H0422810A
	<b>AU4023</b> Z ROT SOL VE SAĞ PLASTİK RB2947	Ağırlık : 0,117 kg / 0.258 lb Malzeme Türü : Plastik Uzunluk : 62 mm / 2.44 inch	8K0505465E, 8K0505465G











\* Bu sayfada ve katalogdaki tüm araçların adları, markaları, modelleri, sembolleri, logoları, orjinal numaraları (oe) ve diğer üçüncü parti numaraları sadece referans amaçlı kullanılmaktadır.







A8	4H	2010 - 2018	
Resim	Ürün Kodu ve Açıklaması	Detay	OEM
	<b>AU4024</b> Z ROT ARKA SAĞ	Ağırlık : 0,508 kg / 1.120 lb Uzunluk : 282,5 mm / 11.12 inch	8K0501530K, 8K0501530N
	<b>AU4025</b> Z ROT ARKA SOL	Ağırlık : 0,508 kg / 1.120 lb Uzunluk : 282,5 mm / 11.12 inch	8K0501529K, 8K0501529N
	<b>AU4034</b> Z ROT ÖN SAĞ-SOL	Ağırlık : 0,170 kg / 0.375 lb Not : FOR ARMoured VEHICLES	4H6411317A
	<b>AU5035</b> SALINCAK ÖN ÜST SAĞ	Malzeme Türü : Alüminyum	4H0407506D, 4H0407506E 4H6407506A, 4H6407506B
	<b>AU5036</b> SALINCAK ÖN ÜST SOL	Malzeme Türü : Alüminyum	4H0407505D, 4H0407505E 4H6407505A, 4H6407505B
	<b>AU5037</b> SALINCAK ÖN ÜST SAĞ	Malzeme Türü : Alüminyum	4H0407510D, 4H0407510E 4H6407510A, 4H6407510B H6407510A
	<b>AU5038</b> SALINCAK ÖN ÜST SOL	Malzeme Türü : Alüminyum	4H0407509D, 4H0407509E 4H6407509A, 4H6407509B
	<b>AU5039</b> SALINCAK ÖN ALT SAĞ	Malzeme Türü : Alüminyum	4H0407152A, 4H0407152B
	<b>AU5040</b> SALINCAK ÖN ALT SOL	Malzeme Türü : Alüminyum	4H0407151A, 4H0407151B
	<b>AU5051</b> SALINCAK ÖN ALT SAĞ	Malzeme Türü : Alüminyum	4H0407694C, 4H0407694D 4H0407694E, 4H0407694F
	<b>AU5052</b> SALINCAK ÖN ALT SOL	Malzeme Türü : Alüminyum	4H0407693C, 4H0407693D 4H0407693E, 4H0407693F

\* Bu sayfada ve katalogdaki tüm araçların adları, markaları, modelleri, sembolleri, logoları, orjinal numaraları (oe) ve diğer üçüncü parti numaraları sadece referans amaçlı kullanılmaktadır.

**A8**
**4H**
**2010 - 2018**







Resim	Ürün Kodu ve Açıklaması	Detay	OEM
	<b>AU11036</b> SALINCAK VE DENGE KOLU BURCU ÖN SOL VE SAĞ	Şasi (Ön / Arka) : ÖN Yön : Sol Ve Sağ Ağırlık : 0,25 kg / 0.551 lb Not : DENGE KOLU BURCU	4H0407515, 8D0407515A 8K0407515, 8R0407515
	<b>AU11049</b> SALINCAK VE DENGE KOLU BURCU SOL VE SAĞ	Yön : Sol Ve Sağ Ağırlık : 0.06 kg / 0.132 lb	4H0407151A-P, 4H0407151B-P 4H0407152A-P, 4H0407152B-P
	<b>AU11060</b> SALINCAK VE DENGE KOLU BURCU ÖN ALT SOL VE SAĞ	Şasi (Ön / Arka) : ÖN Yön : Alt Sol Ve Sağ Ağırlık : 0,248 kg / 0.547 lb	4G0407183, 4G0407183A 4H0407183, 4H0407183B 4H0407183C
	<b>AU11025</b> Z-ROT BURCU ARKA SOL VE SAĞ	Şasi (Ön / Arka) : ARKA Yön : Sol Ve Sağ Ağırlık : 0.032 kg / 0.071 lb Uzunluk : AU4023 mm / 0.00 inch	8K0505465E*, 8K0505465G*
	<b>AU12029</b> ROTMİLİ BURCU VE LASTİĞİ ÖN	Şasi (Ön / Arka) : ÖN	171419804*, 171419804A* 175419804*
	<b>AU12029K</b> ROTMİLİ BURCU VE LASTİĞİ ÖN	Şasi (Ön / Arka) : ÖN	171419804*, 171419804A* 175419804*
	<b>AU12049</b> VİRAJ DEMİR LASTİĞİ	Şasi (Ön / Arka) : ÖN Ağırlık : 0,060 kg / 0.132 lb	8K0411327B
	<b>AU12049K</b> VİRAJ DEMİR LASTİĞİ	Şasi (Ön / Arka) : ÖN Ağırlık : 0,120 kg / 0.265 lb	8K0411327B
	<b>VW12137</b> VİRAJ DEMİR LASTİĞİ	Şasi (Ön / Arka) : ARKA Ağırlık : 0,070 kg / 0.154 lb Not : Ø17mm	1K0511327AQ
	<b>VW12137K</b> VİRAJ DEMİR LASTİĞİ	Şasi (Ön / Arka) : ARKA Ağırlık : 0,140 kg / 0.309 lb Not : KIT	1K0511327AQ
	<b>AU12046</b> ŞANZIMAN TAKOZU	Ağırlık : 1,156 kg / 2.549 lb	4G0399153T, 4M0399153AE

\* Bu sayfada ve katalogdaki tüm araçların adları, markaları, modelleri, sembolleri, logoları, orijinal numaraları (oe) ve diğer üçüncü parti numaraları sadece referans amaçlı kullanılmaktadır.

A8	4N	2018 -	
Resim	Ürün Kodu ve Açıklaması	Detay	OEM
	<b>AU1022</b> ROTİL ÖN ALT ÖNDEN	Ağırlık : 0,580 kg / 1.279 lb	4M0407689B, 4M0407689C
	<b>AU2029</b> ROTBAŞI ÖN SAĞ	Ağırlık : 0,890 kg / 1.962 lb Uzunluk : 221 mm / 8.70 inch	4M0423812B, 4M0423812D
	<b>AU2030</b> ROTBAŞI SOL	Ağırlık : 0,890 kg / 1.962 lb Uzunluk : 221 mm / 8.70 inch	4M0423811B, 4M0423811D
	<b>AU3013</b> ROTMİLİ ÖN SAĞ - SOL	Ağırlık : 0,565 kg / 1.246 lb Uzunluk : 237 mm / 9.33 inch Gövde Dış Çapı : M16X1,5 Aşık Dış Çapı : M16X1,5	4M0423810C
	<b>AU4031</b> Z ROT ÖN ALÜMİNYUM L=170	Ağırlık : 0,201 kg / 0.443 lb Malzeme Türü : Alüminyum Uzunluk : 170 mm / 6.69 inch	4G0411317A, 4G0411317C 4M0411317
	<b>AU4032</b> Z ROT ÖN SAĞ - SOL	Ağırlık : 0,506 kg / 1.116 lb Uzunluk : 174 mm / 6.85 inch Not : ACTIVE SUSPENSION	4M0411317E, 4M0411317F
	<b>AU5079</b> SALINCAK ALT ÖN TARAF SAĞ	Ağırlık : 1,527 kg / 3.366 lb Malzeme Türü : Alüminyum	4M0407152D, 4M0407152F 4M0407152H
	<b>AU5080</b> SALINCAK ALT ÖN TARAF SOL	Ağırlık : 1,527 kg / 3.366 lb Malzeme Türü : Alüminyum	4M0407151D, 4M0407151F 4M0407151H
	<b>AU5081</b> SALINCAK ÜST ARKA TARAF SAĞ	Ağırlık : 3,143 kg / 6.929 lb Malzeme Türü : Alüminyum	4M0407694C, 4M0407694D 4M0407694E, 95840769400
	<b>AU5082</b> SALINCAK ÜST ARKA TARAF SOL	Ağırlık : 3,143 kg / 6.929 lb Malzeme Türü : Alüminyum	4M0407693C, 4M0407693D 4M0407693E, 95840769300
	<b>AU9035</b> SALINCAK VE DENGE KOLU ARKA ÜST SAĞ SAC LEVHA	Ağırlık : 1,245 kg / 2.745 lb Malzeme Türü : Sac Metal	4N0505398A, 80A505398A

\* Bu sayfada ve katalogdaki tüm araçların adları, markaları, modelleri, sembolleri, logoları, orjinal numaraları (oe) ve diğer üçüncü parti numaraları sadece referans amaçlı kullanılmaktadır.

**A8 4N 2018 -**

Resim	Ürün Kodu ve Açıklaması	Detay	OEM
	<b>AU9036</b> SALINCAK VE DENG KOLU ARKA ÜST SOL SAC LEVHA	Ağırlık : 1,245 kg / 2.745 lb Malzeme Türü : Sac Metal	4N0505397A, 80A505397A
	<b>AU11073</b> SALINCAK VE DENG KOLU BURCU ÖN ÜST	Şasi (Ön / Arka) : ÖN Yön : Üst Ağırlık : 0,620 kg / 1.367 lb	4M0407693C, 4M0407693D 4M0407693E, 4M0407694C 4M0407694D, 4M0407694E 95840769300, 95840769400
	<b>AU11075</b> SALINCAK VE DENG KOLU BURCU ÖN ÖN ALT ÖNDEN	Şasi (Ön / Arka) : ÖN Yön : Ön Alt Önden Ağırlık : 0,207 kg / 0.456 lb	4M0407151H*, 4M0407152H* 80A407151A*, 80A407152A*
	<b>AU11076</b> SALINCAK VE DENG KOLU BURCU ÖN ÖN ALT ÖNDEN	Şasi (Ön / Arka) : ÖN Yön : Ön Alt Önden Ağırlık : 0,145 kg / 0.320 lb	4M0407151H*, 4M0407152H*
	<b>AU11078</b> SALINCAK VE DENG KOLU BURCU ARKA ARKA ÜST ARKADAN	Şasi (Ön / Arka) : ARKA Yön : Arka Üst Arkadan Ağırlık : 0,115 kg / 0.254 lb	8W0505397C*, 8W0505397F* 8W0505398C*, 8W0505398F*
	<b>AU11094</b> SALINCAK VE DENG KOLU BURCU ARKA ÜST	Şasi (Ön / Arka) : ARKA Yön : Üst Ağırlık : 0,145 kg / 0.320 lb	4N0505397A*, 4N0505398A* 80A505397A*, 80A505398A*

**ALLROAD QUATTRO 4BH, C5 2000 - 2005**

Resim	Ürün Kodu ve Açıklaması	Detay	OEM
	<b>AU5056</b> SALINCAK ÖN SAĞ ALT	Ağırlık : 385 kg / 848.780 lb Malzeme Türü : Alüminyum	4Z7407694D
	<b>AU5057</b> SALINCAK ÖN SOL ALT	Ağırlık : 385 kg / 848.780 lb Malzeme Türü : Alüminyum	4Z7407693D
	<b>AU5060</b> SALINCAK ÖN ALT	Malzeme Türü : Alüminyum	4Z7407151C
	<b>AU5061</b> SALINCAK ÖN ALT	Malzeme Türü : Alüminyum	4Z7407151G

\* Bu sayfada ve katalogdaki tüm araçların adları, markaları, modelleri, sembolleri, logoları, orjinal numaraları (oe) ve diğer üçüncü parti numaraları sadece referans amaçlı kullanılmaktadır.

**ALLROAD QUATTRO**
**4BH, C5**
**2000 - 2005**

Resim	Ürün Kodu ve Açıklaması	Detay	OEM
	<b>AU11004</b> SALINCAK VE DENGE KOLU BURCU ÖN ORTA SOL VE SAĞ B22112	Şasi (Ön / Arka) : ÖN Yön : Orta Sol Ve Sağ Ağırlık : 0,112 kg / 0.247 lb	4D0407181F, 4D0407181H
	<b>AU11006</b> SALINCAK VE DENGE KOLU BURCU ÖN SOL VE SAĞ	Şasi (Ön / Arka) : ÖN Yön : Sol Ve Sağ Ağırlık : 0,225 kg / 0.496 lb	4D0407182E, 4D0407182G 8E0407182A, 8E0407182E

**CABRIOLET**
**8G7, B4**
**1991 - 2000**

Resim	Ürün Kodu ve Açıklaması	Detay	OEM
	<b>AU1011</b> ROTİL ÖN SOL RB2524	Ağırlık : 0,565 kg / 1.246 lb Bağlantı Delik Çapı : Ø10,5	893.407.365B, 893.407.365D 893407365B, 893407365D 894407365E, 895407365 8A0.407.365, 8A0407365
	<b>AU1012</b> ROTİL ÖN SAĞ RB2525	Ağırlık : 0,565 kg / 1.246 lb Bağlantı Delik Çapı : Ø10,5	893407366B, 894407366E 895407366E, 8A0.407.366 8A0407366
	<b>AU2311</b> ROTBAŞI ÖN SAĞ - SOL RB2311	Ağırlık : 0,218 kg / 0.481 lb Uzunluk : 75 mm / 2.95 inch Gövde Diş Çapı : M14X1,5 Aşık Diş Çapı : M10X1 Aşık Konik Çapı : Ø11	811419812A, 811419812B 8A0419812
	<b>AU6006</b> SALINCAK ÖN SAĞ	Ağırlık : 2,596 kg / 5.723 lb Malzeme Türü : Sac Metal	895407148A*, 895407148A
	<b>AU6006J</b> SALINCAK ÖN SAĞ RB3109	Ağırlık : 1,947 kg / 4.292 lb Malzeme Türü : Sac Metal	895407148A
	<b>AU6007</b> SALINCAK ÖN SOL	Ağırlık : 2,672 kg / 5.891 lb Malzeme Türü : Sac Metal	895407147A*, 895407147A
	<b>AU6007J</b> SALINCAK ÖN SOL RB3108	Ağırlık : 1,987 kg / 4.381 lb Malzeme Türü : Sac Metal	895407147A
	<b>AU11001</b> SALINCAK VE DENGE KOLU BURCU ÖN İÇ SOL VE SAĞ B22128	Şasi (Ön / Arka) : ÖN Yön : İç Sol Ve Sağ Ağırlık : 0,158 kg / 0.348 lb Not : L=44mm/İN D=Ø10,2mm/O D=Ø37,1m	857407181, 8A0407181

\* Bu sayfada ve katalogdaki tüm araçların adları, markaları, modelleri, sembolleri, logoları, orijinal numaraları (oe) ve diğer üçüncü parti numaraları sadece referans amaçlı kullanılmaktadır.

**CABRIOLET**
**8G7, B4**
**1991 - 2000**



Resim	Ürün Kodu ve Açıklaması	Detay	OEM
	<b>AU11030</b> SALINCAK VE DENGE KOLU BURCU SOL VE SAĞ	Yön : Sol Ve Sağ Ağırlık : 0,21 kg / 0.463 lb	893407181
	<b>AU12015</b> TAŞIYICI DESTEK BURÇLARI ARKA SOL VE SAĞ	Şasi (Ön / Arka) : ARKA Yön : Sol Ve Sağ Ağırlık : 0,12 kg / 0.265 lb	811511247
	<b>AU12015K</b> TAŞIYICI DESTEK BURÇLARI ARKA SOL VE SAĞ	Şasi (Ön / Arka) : ARKA Yön : Sol Ve Sağ Ağırlık : 0,24 kg / 0.529 lb	811511247
	<b>VW12104</b> AMORTİSÖR TAKOZU SOL VE SAĞ AMORTİSOR TABLASI	Yön : Sol Ve Sağ Ağırlık : 0,257 kg / 0.567 lb Not : AMORTİSOR TABLASI	811412323C, 811412323D 8A0412323B, 8A0412323D
	<b>VW12104K</b> AMORTİSÖR TAKOZU SOL VE SAĞ 2 PCS	Yön : Sol Ve Sağ Ağırlık : 0,514 kg / 1.133 lb Not : 2 PCS	811412323C, 811412323D 8A0412323B, 8A0412323D
	<b>AU12010</b> MOTOR TAKOZU ÖN SOL VE SAĞ ŞANZUMAN TAKOZU	Şasi (Ön / Arka) : ÖN Yön : Sol Ve Sağ Ağırlık : 0,4 kg / 0.882 lb Not : ŞANZUMAN TAKOZU	893399151A
	<b>AU12016</b> ŞANZIMAN TAKOZU SOL VE SAĞ ŞANZUMAN TAKOZU	Yön : Sol Ve Sağ Ağırlık : 0,267 kg / 0.589 lb Not : ŞANZUMAN TAKOZU	431399151D
	<b>AU12034</b> ŞANZIMAN TAKOZU	Ağırlık : 0,556 kg / 1.226 lb	811199339A, 811199339B 823199339A

**COUPE**
**1982 - 1988**

Resim	Ürün Kodu ve Açıklaması	Detay	OEM
	<b>AU1005</b> ROTİL ÖN SAĞ RB2517	Ağırlık : 0,59 kg / 1.301 lb Bağlantı Delik Çapı : Ø10,5	893407366, 893407366F
	<b>AU1006</b> ROTİL ÖN SOL RB2516	Ağırlık : 0,59 kg / 1.301 lb Bağlantı Delik Çapı : Ø10,5	893407365, 893407365B 893407365F

\* Bu sayfada ve katalogdaki tüm araçların adları, markaları, modelleri, sembolleri, logoları, orjinal numaraları (oe) ve diğer üçüncü parti numaraları sadece referans amaçlı kullanılmaktadır.

**COUPE**
**1982 - 1988**

Resim	Ürün Kodu ve Açıklaması	Detay	OEM
	<b>AU1011</b> ROTİL ÖN SOL RB2524	Ağırlık : 0,565 kg / 1.246 lb Bağlantı Delik Çapı : Ø10,5	893.407.365B, 893.407.365D 893407365B, 893407365D 894407365E, 895407365 8A0.407.365, 8A0407365
	<b>AU1012</b> ROTİL ÖN SAĞ RB2525	Ağırlık : 0,565 kg / 1.246 lb Bağlantı Delik Çapı : Ø10,5	893407366B, 894407366E 895407366, 8A0.407.366 8A0407366
	<b>AU2311</b> ROTBAŞI ÖN SAĞ - SOL RB2311	Ağırlık : 0,218 kg / 0.481 lb Uzunluk : 75 mm / 2.95 inch Gövde Diş Çapı : M14X1,5 Aşık Diş Çapı : M10X1 Aşık Konik Çapı : Ø11	811419812A, 811419812B 8A0419812
	<b>AU4003</b> Z ROT SAĞ RB2913	Ağırlık : 0,406 kg / 0.895 lb Uzunluk : 226,5 mm / 8.92 inch Aşık Diş Çapı : M10X1,5	8A0505466C, 8D0505466
	<b>AU4004</b> Z ROT SOL RB2914	Ağırlık : 0,404 kg / 0.891 lb Uzunluk : 226,5 mm / 8.92 inch Aşık Diş Çapı : M10X1,5	8A0505465C, 8D0505465
	<b>AU6006</b> SALINCAK ÖN SAĞ	Ağırlık : 2,596 kg / 5.723 lb Malzeme Türü : Sac Metal	895407148A*, 895407148A
	<b>AU6006J</b> SALINCAK ÖN SAĞ RB3109	Ağırlık : 1,947 kg / 4.292 lb Malzeme Türü : Sac Metal	895407148A
	<b>AU6007</b> SALINCAK ÖN SOL	Ağırlık : 2,672 kg / 5.891 lb Malzeme Türü : Sac Metal	895407147A*, 895407147A
	<b>AU6007J</b> SALINCAK ÖN SOL RB3108	Ağırlık : 1,987 kg / 4.381 lb Malzeme Türü : Sac Metal	895407147A
	<b>AU11001</b> SALINCAK VE DENGE KOLU BURCU ÖN İÇ SOL VE SAĞ B22128	Şasi (Ön / Arka) : ÖN Yön : İç Sol Ve Sağ Ağırlık : 0,158 kg / 0.348 lb Not : L=44mm/IN D=Ø10,2mm/O D=Ø37,1m	857407181, 8A0407181
	<b>AU11046</b> SALINCAK VE DENGE KOLU BURCU SOL VE SAĞ	Yön : Sol Ve Sağ Ağırlık : 0,118 kg / 0.260 lb	811407181, 811407181A

\* Bu sayfada ve katalogdaki tüm araçların adları, markaları, modelleri, sembolleri, logoları, orjinal numaraları (oe) ve diğer üçüncü parti numaraları sadece referans amaçlı kullanılmaktadır.





**COUPE**
**1982 - 1988**

Resim	Ürün Kodu ve Açıklaması	Detay	OEM
	<b>AU11046K</b> SALINCAK VE DENGE KOLU BURCU SOL VE SAĞ	Yön : Sol Ve Sağ Ağırlık : 0,236 kg / 0.520 lb	811407181, 811407181A
	<b>AU11024</b> Z-ROT BURCU ARKA	Şasi (Ön / Arka) : ARKA Ağırlık : 0.55 kg / 1.213 lb Uzunluk : AU4003 mm / 0.00 inch Aşık Diş Çapı : AU4004	8A0505465C*, 8A0505466C* 8D0505465*, 8D0505466*
	<b>AU12015</b> TAŞIYICI DESTEK BURÇLARI ARKA SOL VE SAĞ	Şasi (Ön / Arka) : ARKA Yön : Sol Ve Sağ Ağırlık : 0,12 kg / 0.265 lb	811511247
	<b>AU12015K</b> TAŞIYICI DESTEK BURÇLARI ARKA SOL VE SAĞ	Şasi (Ön / Arka) : ARKA Yön : Sol Ve Sağ Ağırlık : 0,24 kg / 0.529 lb	811511247
	<b>AU12008</b> VİRAJ DEMİR LASTİĞİ SOL VE SAĞ RUBBER	Şasi (Ön / Arka) : ÖN Yön : Sol Ve Sağ Ağırlık : 0,03 kg / 0.066 lb Malzeme Türü : Rubber	823411313A*, 823411313A
	<b>AU12008K</b> VİRAJ DEMİR LASTİĞİ SOL VE SAĞ RUBBER	Şasi (Ön / Arka) : ÖN Yön : Sol Ve Sağ Ağırlık : 0.06 kg / 0.132 lb Malzeme Türü : Rubber	823411313A*
	<b>VW12104</b> AMORTİSÖR TAKOZU SOL VE SAĞ AMORTİSOR TABLASI	Yön : Sol Ve Sağ Ağırlık : 0,257 kg / 0.567 lb Not : AMORTİSOR TABLASI	811412323C, 811412323D 8A0412323B, 8A0412323D
	<b>VW12104K</b> AMORTİSÖR TAKOZU SOL VE SAĞ 2 PCS	Yön : Sol Ve Sağ Ağırlık : 0.514 kg / 1.133 lb Not : 2 PCS	811412323C, 811412323D 8A0412323B, 8A0412323D
	<b>AU12009</b> MOTOR TAKOZU ÖN SOL VE SAĞ	Şasi (Ön / Arka) : ÖN Yön : Sol Ve Sağ Ağırlık : 0,464 kg / 1.023 lb	823199381B, 893199381B
	<b>AU12010</b> MOTOR TAKOZU ÖN SOL VE SAĞ ŞANZUMAN TAKOZU	Şasi (Ön / Arka) : ÖN Yön : Sol Ve Sağ Ağırlık : 0,4 kg / 0.882 lb Not : ŞANZUMAN TAKOZU	893399151A
	<b>AU12014</b> MOTOR TAKOZU ÖN SOL VE SAĞ TRAVERS BURCU ARKA	Şasi (Ön / Arka) : ÖN Yön : Sol Ve Sağ Ağırlık : 0,118 kg / 0.260 lb Not : TRAVERS BURCU ARKA	811199419B, 811199419C 893199419





\* Bu sayfada ve katalogdaki tüm araçların adları, markaları, modelleri, sembolleri, logoları, orjinal numaraları (oe) ve diğer üçüncü parti numaraları sadece referans amaçlı kullanılmaktadır.



**COUPE**
**1982 - 1988**





Resim	Ürün Kodu ve Açıklaması	Detay	OEM
	<b>AU12011</b> ŞANZIMAN TAKOZU SOL VE SAĞ ŞANZUMAN TAKOZU	Şasi (Ön / Arka) : ÖN Yön : Sol Ve Sağ Ağırlık : 0,26 kg / 0.573 lb Not : ŞANZUMAN TAKOZU	811399151B
	<b>AU12016</b> ŞANZIMAN TAKOZU SOL VE SAĞ ŞANZUMAN TAKOZU	Yön : Sol Ve Sağ Ağırlık : 0,267 kg / 0.589 lb Not : ŞANZUMAN TAKOZU	431399151D
	<b>AU12034</b> ŞANZIMAN TAKOZU	Ağırlık : 0,556 kg / 1.226 lb	811199339A, 811199339B 823199339A
	<b>OP14003</b> AKS KÖRÜĞÜ +KELEPÇE+YAĞ. AKS KÖRÜĞÜ DIŞ	Ağırlık : 0.2 kg / 0.441 lb	1603180
	<b>VW14013</b> AKS KÖRÜĞÜ +KELEPÇE+YAĞ. YAĞ+KELEPÇE	Ağırlık : 0.156 kg / 0.344 lb	113501149, 171407283A

**COUPE QUATTRO**
**1988 - 1996**

Resim	Ürün Kodu ve Açıklaması	Detay	OEM
	<b>AU1003</b> ROTİL ÖN SAĞ RB2515	Ağırlık : 0,58 kg / 1.279 lb Bağlantı Delik Çapı : Ø10,5	855407366A, 855407366B
	<b>AU1004</b> ROTİL ÖN SOL RB2514	Ağırlık : 0,58 kg / 1.279 lb Bağlantı Delik Çapı : Ø10,5	855407365A, 855407365B
	<b>AU1011</b> ROTİL ÖN SOL RB2524	Ağırlık : 0,565 kg / 1.246 lb Bağlantı Delik Çapı : Ø10,5	893.407.365B, 893.407.365D 893407365B, 893407365D 894407365E, 895407365 8A0.407.365, 8A0407365
	<b>AU1012</b> ROTİL ÖN SAĞ RB2525	Ağırlık : 0,565 kg / 1.246 lb Bağlantı Delik Çapı : Ø10,5	893407366B, 894407366E 895407366, 8A0.407.366 8A0407366
	<b>AU2311</b> ROTBAŞI ÖN SAĞ - SOL RB2311	Ağırlık : 0,218 kg / 0.481 lb Uzunluk : 75 mm / 2.95 inch Gövde Diş Çapı : M14X1,5 Aşık Diş Çapı : M10X1 Aşık Konik Çapı : Ø11	811419812A, 811419812B 8A0419812

\* Bu sayfada ve katalogdaki tüm araçların adları, markaları, modelleri, sembolleri, logoları, orjinal numaraları (oe) ve diğer üçüncü parti numaraları sadece referans amaçlı kullanılmaktadır.

**COUPE QUATTRO**
**1988 - 1996**

Resim	Ürün Kodu ve Açıklaması	Detay	OEM
	<b>AU4001</b> Z ROT SOL VE SAĞ METAL RB2911	Ağırlık : 0,357 kg / 0.787 lb Malzeme Türü : Metal Uzunluk : 270 mm / 10.63 inch Aşık Diş Çapı : M10X1,5	893407465, 893407465A 8A0407465, 8A0407465B 8A0407465C
	<b>AU4001A</b> Z ROT ÖN PLASTİK	Ağırlık : 0,295 kg / 0.650 lb Malzeme Türü : Plastik Uzunluk : 317 mm / 12.48 inch	893407465, 893407465A 8A0407465, 8A0407465B 8A0407465C
	<b>AU4003</b> Z ROT SAĞ RB2913	Ağırlık : 0,406 kg / 0.895 lb Uzunluk : 226,5 mm / 8.92 inch Aşık Diş Çapı : M10X1,5	8A0505466C, 8D0505466
	<b>AU4004</b> Z ROT SOL RB2914	Ağırlık : 0,404 kg / 0.891 lb Uzunluk : 226,5 mm / 8.92 inch Aşık Diş Çapı : M10X1,5	8A0505465C, 8D0505465
	<b>AU4022</b> Z ROT ARKA	Ağırlık : 0.873 kg / 1.925 lb	893505389, 895505389
	<b>AU6002J</b> SALINCAK ÖN SAĞ RB3105	Ağırlık : 2,226 kg / 4.907 lb Malzeme Türü : Sac Metal	893407148C
	<b>AU6003J</b> SALINCAK ÖN SOL RB3106	Ağırlık : 2,147 kg / 4.733 lb Malzeme Türü : Sac Metal	893407147C, 893407147E
	<b>AU6004J</b> SALINCAK ÖN SAĞ RB3107	Ağırlık : 2,185 kg / 4.817 lb Malzeme Türü : Sac Metal	893407148E
	<b>AU6005J</b> SALINCAK ÖN SOL	Ağırlık : 2,178 kg / 4.802 lb Malzeme Türü : Sac Metal	893407147E
	<b>AU6006</b> SALINCAK ÖN SAĞ	Ağırlık : 2,596 kg / 5.723 lb Malzeme Türü : Sac Metal	895407148A*, 895407148A
	<b>AU6006J</b> SALINCAK ÖN SAĞ RB3109	Ağırlık : 1,947 kg / 4.292 lb Malzeme Türü : Sac Metal	895407148A

\* Bu sayfada ve katalogdaki tüm araçların adları, markaları, modelleri, sembolleri, logoları, orjinal numaraları (oe) ve diğer üçüncü parti numaraları sadece referans amaçlı kullanılmaktadır.

**COUPE QUATTRO**
**1988 - 1996**

Resim	Ürün Kodu ve Açıklaması	Detay	OEM
	<b>AU6007</b> SALINCAK ÖN SOL	Ağırlık : 2,672 kg / 5.891 lb Malzeme Türü : Sac Metal	895407147A*, 895407147A
	<b>AU6007J</b> SALINCAK ÖN SOL RB3108	Ağırlık : 1,987 kg / 4.381 lb Malzeme Türü : Sac Metal	895407147A
	<b>AU11001</b> SALINCAK VE DENGE KOLU BURCU ÖN İÇ SOL VE SAĞ B22128	Şasi (Ön / Arka) : ÖN Yön : İç Sol Ve Sağ Ağırlık : 0,158 kg / 0.348 lb Not : L=44mm/IN D=Ø10,2mm/O D=Ø37,1m	857407181, 8A0407181
	<b>AU11030</b> SALINCAK VE DENGE KOLU BURCU SOL VE SAĞ	Yön : Sol Ve Sağ Ağırlık : 0,21 kg / 0.463 lb	893407181
	<b>AU11024</b> Z-ROT BURCU ARKA	Şasi (Ön / Arka) : ARKA Ağırlık : 0.55 kg / 1.213 lb Uzunluk : AU4003 mm / 0.00 inch Aşık Dış Çapı : AU4004	8A0505465C*, 8A0505466C* 8D0505465*, 8D0505466*
	<b>AU12015</b> TAŞIYICI DESTEK BURÇLARI ARKA SOL VE SAĞ	Şasi (Ön / Arka) : ARKA Yön : Sol Ve Sağ Ağırlık : 0,12 kg / 0.265 lb	811511247
	<b>AU12015K</b> TAŞIYICI DESTEK BURÇLARI ARKA SOL VE SAĞ	Şasi (Ön / Arka) : ARKA Yön : Sol Ve Sağ Ağırlık : 0,24 kg / 0.529 lb	811511247
	<b>AU12010</b> MOTOR TAKOZU ÖN SOL VE SAĞ ŞANZUMAN TAKOZU	Şasi (Ön / Arka) : ÖN Yön : Sol Ve Sağ Ağırlık : 0,4 kg / 0.882 lb Not : ŞANZUMAN TAKOZU	893399151A
	<b>AU12014</b> MOTOR TAKOZU ÖN SOL VE SAĞ TRAVERS BURCU ARKA	Şasi (Ön / Arka) : ÖN Yön : Sol Ve Sağ Ağırlık : 0,118 kg / 0.260 lb Not : TRAVERS BURCU ARKA	811199419B, 811199419C 893199419
	<b>AU12016</b> ŞANZIMAN TAKOZU SOL VE SAĞ ŞANZUMAN TAKOZU	Yön : Sol Ve Sağ Ağırlık : 0,267 kg / 0.589 lb Not : ŞANZUMAN TAKOZU	431399151D
	<b>AU12034</b> ŞANZIMAN TAKOZU	Ağırlık : 0,556 kg / 1.226 lb	811199339A, 811199339B 823199339A











\* Bu sayfada ve katalogdaki tüm araçların adları, markaları, modelleri, sembolleri, logoları, orjinal numaraları (oe) ve diğer üçüncü parti numaraları sadece referans amaçlı kullanılmaktadır.

**E-TRON**
**2018 -**

Resim	Ürün Kodu ve Açıklaması	Detay	OEM
	<b>AU1022</b> ROTİL ÖN ALT ÖNDEN	Ağırlık : 0,580 kg / 1.279 lb	4M0407689B, 4M0407689C
	<b>AU2029</b> ROTBAŞI ÖN SAĞ	Ağırlık : 0,890 kg / 1.962 lb Uzunluk : 221 mm / 8.70 inch	4M0423812B, 4M0423812D
	<b>AU2030</b> ROTBAŞI SOL	Ağırlık : 0,890 kg / 1.962 lb Uzunluk : 221 mm / 8.70 inch	4M0423811B, 4M0423811D
	<b>AU3013</b> ROTMİLİ ÖN SAĞ - SOL	Ağırlık : 0,565 kg / 1.246 lb Uzunluk : 237 mm / 9.33 inch Gövde Diş Çapı : M16X1,5 Aşık Diş Çapı : M16X1,5	4M0423810C
	<b>AU4031</b> Z ROT ÖN ALÜMİNYUM L=170	Ağırlık : 0,201 kg / 0.443 lb Malzeme Türü : Alüminyum Uzunluk : 170 mm / 6.69 inch	4G0411317A, 4G0411317C 4M0411317
	<b>AU4033</b> Z ROT ARKA SAĞ - SOL ALÜMİNYUM	Ağırlık : 0,320 kg / 0.705 lb Malzeme Türü : Alüminyum Uzunluk : 174 mm / 6.85 inch	4M0505465D
	<b>AU5075</b> SALINCAK ÜST ARKA TARAF SAĞ	Ağırlık : 0,55 kg / 1.213 lb Malzeme Türü : Alüminyum	4M0407510B, 4M0407510C 80A407510A
	<b>AU5076</b> SALINCAK ÜST ARKA TARAF SOL	Ağırlık : 0,55 kg / 1.213 lb Malzeme Türü : Alüminyum	4M0407509B, 4M0407509C 80A407509A
	<b>AU5079</b> SALINCAK ALT ÖN TARAF SAĞ	Ağırlık : 1,527 kg / 3.366 lb Malzeme Türü : Alüminyum	4M0407152D, 4M0407152F 4M0407152H
	<b>AU5080</b> SALINCAK ALT ÖN TARAF SOL	Ağırlık : 1,527 kg / 3.366 lb Malzeme Türü : Alüminyum	4M0407151D, 4M0407151F 4M0407151H
	<b>AU5081</b> SALINCAK ÜST ARKA TARAF SAĞ	Ağırlık : 3,143 kg / 6.929 lb Malzeme Türü : Alüminyum	4M0407694C, 4M0407694D 4M0407694E, 95840769400

\* Bu sayfada ve katalogdaki tüm araçların adları, markaları, modelleri, sembolleri, logoları, orjinal numaraları (oe) ve diğer üçüncü parti numaraları sadece referans amaçlı kullanılmaktadır.

**E-TRON**
**2018 -**

Resim	Ürün Kodu ve Açıklaması	Detay	OEM
	<b>AU5082</b> SALINCAK ÜST ARKA TARAF SOL	Ağırlık : 3,143 kg / 6.929 lb Malzeme Türü : Alüminyum	4M0407693C, 4M0407693D 4M0407693E, 95840769300
	<b>AU9022</b> SALINCAK ARKA ALT ARKADAN	Ağırlık : 1,322 kg / 2.915 lb Malzeme Türü : Alüminyum	4M0501529L
	<b>AU9029</b> SALINCAK ARKA ALT ARKADAN	Ağırlık : 0,811 kg / 1.788 lb Malzeme Türü : Alüminyum	4M0505323G
	<b>AU9031</b> SALINCAK VE DENG KOLU ARKA ÜST SAĞ ALÜMİNYUM	Ağırlık : 1,545 kg / 3.406 lb Malzeme Türü : Alüminyum	4K0505398A, 4M0505398L
	<b>AU9032</b> SALINCAK VE DENG KOLU ARKA ÜST SOL ALÜMİNYUM	Ağırlık : 1,545 kg / 3.406 lb Malzeme Türü : Alüminyum	4K0505397A, 4M0505397L
	<b>AU9033</b> SALINCAK ARKA ÖNDEN SAĞ ALÜMİNYUM	Ağırlık : 0,945 kg / 2.083 lb Malzeme Türü : Alüminyum	4M0505292F
	<b>AU9034</b> SALINCAK VE DENG KOLU ARKA ÖNDEN SOL ALÜMİNYUM	Ağırlık : 0,945 kg / 2.083 lb Malzeme Türü : Alüminyum	4M0505291F
	<b>AU11071</b> SALINCAK VE DENG KOLU BURCU ARKA ALT	Şasi (Ön / Arka) : ARKA Yön : Alt Ağırlık : 0,250 kg / 0.551 lb	4M0501529L*, 4M0501529N* 4M0501530N*
	<b>AU11072</b> SALINCAK VE DENG KOLU BURCU ARKA ALT	Şasi (Ön / Arka) : ARKA Yön : Alt Ağırlık : 0,250 kg / 0.551 lb	4M0501529L*, 4M0501529N* 4M0501530N*
	<b>AU11073</b> SALINCAK VE DENG KOLU BURCU ÖN ÜST	Şasi (Ön / Arka) : ÖN Yön : Üst Ağırlık : 0,620 kg / 1.367 lb	4M0407693C, 4M0407693D 4M0407693E, 4M0407694C 4M0407694D, 4M0407694E 95840769300, 95840769400
	<b>AU11075</b> SALINCAK VE DENG KOLU BURCU ÖN ÖN ALT ÖNDEN	Şasi (Ön / Arka) : ÖN Yön : Ön Alt Önden Ağırlık : 0,207 kg / 0.456 lb	4M0407151H*, 4M0407152H* 80A407151A*, 80A407152A*

\* Bu sayfada ve katalogdaki tüm araçların adları, markaları, modelleri, sembolleri, logoları, orjinal numaraları (oe) ve diğer üçüncü parti numaraları sadece referans amaçlı kullanılmaktadır.

**E-TRON**
**2018 -**

Resim	Ürün Kodu ve Açıklaması	Detay	OEM
	<b>AU11076</b> SALINCAK VE DENGE KOLU BURCU ÖN ÖN ALT ÖNDEN	Şasi (Ön / Arka) : ÖN Yön : Ön Alt Önden Ağırlık : 0,145 kg / 0.320 lb	4M0407151H*, 4M0407152H*
	<b>AU11078</b> SALINCAK VE DENGE KOLU BURCU ARKA ARKA ÜST ARKADAN	Şasi (Ön / Arka) : ARKA Yön : Arka Üst Arkadan Ağırlık : 0,115 kg / 0.254 lb	8W0505397C*, 8W0505397F* 8W0505398C*, 8W0505398F*
	<b>AU11083</b> SALINCAK VE DENGE KOLU BURCU ARKA İÇ ÜST	Şasi (Ön / Arka) : ARKA Yön : İç Üst Ağırlık : 0,105 kg / 0.231 lb	8W0505323F*, 8W0505324F*
	<b>AU11093</b> SALINCAK VE DENGE KOLU BURCU ARKA ÖNDEN	Şasi (Ön / Arka) : ARKA Yön : Önden Ağırlık : 0,115 kg / 0.254 lb	4M0505291F*, 4M0505292F*

**Q2**
**GA**
**2017 - 2023**

Resim	Ürün Kodu ve Açıklaması	Detay	OEM
	<b>VW2008</b> ROTBAŞI ÖN SAĞ RD0342	Ağırlık : 0,412 kg / 0.908 lb Uzunluk : 95 mm / 3.74 inch Gövde Diş Çapı : M16X1,5 Aşık Diş Çapı : M12X1,5 Aşık Konik Çapı : Ø12,7	1K0423812A, 1K0423812C 1K0423812E, 1K0423812G 1K0423812J, 1K0423812K 1KD423812A
	<b>VW2009</b> ROTBAŞI ÖN SOL RD0343	Ağırlık : 0,412 kg / 0.908 lb Uzunluk : 95 mm / 3.74 inch Gövde Diş Çapı : M16X1,5 Aşık Diş Çapı : M12X1,5 Aşık Konik Çapı : Ø13,5	1K0423811A, 1K0423811C 1K0423811E, 1K0423811G 1K0423811J, 1K0423811K 1KD423811A
	<b>VW3009</b> ROTMİLİ SAĞ-SOL 310 RB2838	Ağırlık : 0,665 kg / 1.466 lb Uzunluk : 311 mm / 12.24 inch Gövde Diş Çapı : M16X1,5 Aşık Diş Çapı : M16X1,5	1K0423810A
	<b>VW20083009</b> ROT TAKIMI ÖN AKS SAĞ RB288137	Ağırlık : 1,078 kg / 2.377 lb Rotbaşı : VW2008 Rotmilî : VW3009	
	<b>VW20093009</b> ROT TAKIMI ÖN SOL RB288138	Ağırlık : 1,077 kg / 2.374 lb Rotbaşı : VW2009 Rotmilî : VW3009	
	<b>VW4014</b> Z ROT ÖN SAĞ-SOL METAL 335 RB2935	Ağırlık : 0,46 kg / 1.014 lb Malzeme Türü : Metal Uzunluk : 335 mm / 13.19 inch Aşık Diş Çapı : M12X1,5	1K0411315B, 1K0411315D 1K0411315J, 1K0411315K 1K0411315R, 5Q0411315A 5Q0411315B

\* Bu sayfada ve katalogdaki tüm araçların adları, markaları, modelleri, sembolleri, logoları, orjinal numaraları (oe) ve diğer üçüncü parti numaraları sadece referans amaçlı kullanılmaktadır.

**Q2 GA 2017 - 2023**

Resim	Ürün Kodu ve Açıklaması	Detay	OEM
	<b>VW4031</b> Z ROT ARKA PLASTİK	Ağırlık : 0,15 kg / 0.331 lb Malzeme Türü : Plastik Uzunluk : 70 mm / 2.76 inch Aşık Diş Çapı : M10X1,5	5Q0505465A, 5Q0505465C
	<b>AU9009</b> SALINCAK ALT SOL VE SAĞ	Ağırlık : 2,910 kg / 6.415 lb Malzeme Türü : Sac Metal	5Q0505311C, 5Q0505311D
	<b>AU9012</b> SALINCAK ARKA ALT SAĞ	Ağırlık : 1,640 kg / 3.616 lb Malzeme Türü : Sac Metal	5Q0505224D
	<b>AU9013</b> SALINCAK ARKA ALT SOL	Ağırlık : 1,640 kg / 3.616 lb Malzeme Türü : Sac Metal	5Q0505223D
	<b>AU11068</b> SALINCAK VE DENG KOLU BURCU ARKA ALT SOL VE SAĞ METAL	Şasi (Ön / Arka) : ARKA Yön : Alt Sol Ve Sağ Ağırlık : 0,201 kg / 0.443 lb Malzeme Türü : Metal	PART OF 5Q0505223D, PART OF 5Q0505224D
	<b>AU11070</b> SALINCAK VE DENG KOLU BURCU ARKA ALT	Şasi (Ön / Arka) : ARKA Yön : Alt Ağırlık : 0,100 kg / 0.220 lb	5Q0505171, 5Q0505311C 5Q0505311CSK, 5Q0505311D 5Q0505311DSK
	<b>AU12022</b> MOTOR TAKOZU SOL VE SAĞ MOTOR TAKOZU	Yön : Sol Ve Sağ Ağırlık : 1.58 kg / 3.483 lb Malzeme Türü : Motor Takozu	5Q0199262, 5Q0199262BH 5Q0199262DE
	<b>AU12023</b> MOTOR TAKOZU SOL VE SAĞ MOTOR TAKOZU 7 İLERİ	Yön : Sol Ve Sağ Ağırlık : 1.58 kg / 3.483 lb Malzeme Türü : Motor Takozu Not : 7 İLERİ	5Q0199262BE, 5Q0199262BF
	<b>SK12005</b> MOTOR TAKOZU ÖN SAĞ	Şasi (Ön / Arka) : ÖN Yön : Sağ Ağırlık : 1,575 kg / 3.472 lb	5Q0199262CK

**Q3 8U 2011 - 2016**





Resim	Ürün Kodu ve Açıklaması	Detay	OEM
	<b>VW1014</b> ROTİL ÖN ALT SAĞ Ø15,6 RB2536	Ağırlık : 0,565 kg / 1.246 lb Konik Ölçüsü : Ø15,6 Bağlantı Delik Çapı : Ø10,5 Aşık Diş Çapı : M12X1,5	1K0407366B, 1K0407366C 1K0407366E, 5Q0407366A

\* Bu sayfada ve katalogdaki tüm araçların adları, markaları, modelleri, sembolleri, logoları, orjinal numaraları (oe) ve diğer üçüncü parti numaraları sadece referans amaçlı kullanılmaktadır.

**Q3**

**8U**

**2011 - 2016**

Resim	Ürün Kodu ve Açıklaması	Detay	OEM
	<b>VW1015</b> ROTİL ÖN ALT SOL Ø15,6 RB2537	Ağırlık : 0,565 kg / 1.246 lb Konik Ölçüsü : Ø15,6 Bağlantı Delik Çapı : Ø10,5 Aşık Diş Çapı : M12X1,5	1K0407365B, 1K0407365C 1K0407365E, 5Q0407365A
	<b>VW2008</b> ROTBAŞI ÖN SAĞ RD0342	Ağırlık : 0,412 kg / 0.908 lb Uzunluk : 95 mm / 3.74 inch Gövde Diş Çapı : M16X1,5 Aşık Diş Çapı : M12X1,5 Aşık Konik Çapı : Ø12,7	1K0423812A, 1K0423812C 1K0423812E, 1K0423812G 1K0423812J, 1K0423812K 1KD423812A
	<b>VW2009</b> ROTBAŞI ÖN SOL RD0343	Ağırlık : 0,412 kg / 0.908 lb Uzunluk : 95 mm / 3.74 inch Gövde Diş Çapı : M16X1,5 Aşık Diş Çapı : M12X1,5 Aşık Konik Çapı : Ø13,5	1K0423811A, 1K0423811C 1K0423811E, 1K0423811G 1K0423811J, 1K0423811K 1KD423811A
	<b>VW3009</b> ROTMİLİ SAĞ-SOL 310 RB2838	Ağırlık : 0,665 kg / 1.466 lb Uzunluk : 311 mm / 12.24 inch Gövde Diş Çapı : M16X1,5 Aşık Diş Çapı : M16X1,5	1K0423810A



## VW8002 / Süspansiyon Kit Ön

Q3

8U

2011 - 2016













### Kit Parçaları

Resim	Ürün Kodu / Adı	OEM	OEM	Ürün Kodu / Adı	Resim
	<b>VW2008</b> Rotbaşı Ön Sağ Rd0342	1K0423812A, 1K0423812C 1K0423812E, 1K0423812G 1K0423812J, 1K0423812K 1KD423812A	1K0423811A, 1K0423811C 1K0423811E, 1K0423811G 1K0423811J, 1K0423811K 1KD423811A	<b>VW2009</b> Rotbaşı Ön Sol Rd0343	
	<b>VW3009</b> Rotmili Sağ-sol 310 Rb2838	1K0423810A	1K0411315B, 1K0411315D 1K0411315J, 1K0411315K 1K0411315R, 5Q0411315A 5Q0411315B	<b>VW4014</b> Z Rot Ön Sağ-sol Metal 335 Rb2935	
	<b>VW6032</b> Salıncak Ön Sağ Rd1051	3C0407151A, 3C0407151B 3C0407151E, 3C0407151G*	3C0407151A, 3C0407151B 3C0407151E, 3C0407151H*	<b>VW6033</b> Salıncak Ön Sol Rd1052	

\* Bu sayfada ve katalogdaki tüm araçların adları, markaları, modelleri, sembolleri, logoları, orjinal numaraları (oe) ve diğer üçüncü parti numaraları sadece referans amaçlı kullanılmaktadır.

**Q3**
**8U**
**2011 - 2016**

Resim	Ürün Kodu ve Açıklaması	Detay	OEM
	<b>VW20083009</b> ROT TAKIMI ÖN AKS SAĞ RB288137	Ağırlık : 1,078 kg / 2.377 lb Rotbaşı : VW2008 Rotmilii : VW3009	
	<b>VW20093009</b> ROT TAKIMI ÖN SOL RB288138	Ağırlık : 1,077 kg / 2.374 lb Rotbaşı : VW2009 Rotmilii : VW3009	
	<b>SK4005</b> Z ROT ÖM SAĞ-SOL L=335MM	Ağırlık : 0,322 kg / 0.710 lb Malzeme Türü : Metal Uzunluk : 335 mm / 13.19 inch Aşık Diş Çapı : M12X1,5	5Q0411315B
	<b>VW4014</b> Z ROT ÖN SAĞ-SOL METAL 335 RB2935	Ağırlık : 0,46 kg / 1.014 lb Malzeme Türü : Metal Uzunluk : 335 mm / 13.19 inch Aşık Diş Çapı : M12X1,5	1K0411315B, 1K0411315D 1K0411315J, 1K0411315K 1K0411315R, 5Q0411315A 5Q0411315B
	<b>VW4015</b> Z ROT SOL VE SAĞ METAL RB2937	Ağırlık : 0,373 kg / 0.822 lb Malzeme Türü : Metal Uzunluk : 95,5 mm / 3.76 inch Aşık Diş Çapı : M10X1,5	1K0505465C, 1K0505465D 1K0505465H, 1K0505465J 1K0505465K
	<b>VW4015K</b> Z ROT SOL VE SAĞ METAL	Ağırlık : 0,373 kg / 0.822 lb Malzeme Türü : Metal Uzunluk : 95,5 mm / 3.76 inch Aşık Diş Çapı : M10X1,5	1K0505465C, 1K0505465D 1K0505465H, 1K0505465J 1K0505465K
	<b>AU6010</b> SALINCAK ÜST SOL VE SAĞ RA5155	Ağırlık : 1,298 kg / 2.862 lb Malzeme Türü : Sac Metal	1K0505323H, 1K0505323N
	<b>AU9003</b> SALINCAK ARKA ALT SAĞ	Ağırlık : 1,733 kg / 3.821 lb Malzeme Türü : Sac Metal	3C0505224D
	<b>AU9004</b> SALINCAK ARKA ALT SOL	Ağırlık : 1,733 kg / 3.821 lb Malzeme Türü : Sac Metal	3C0505223DÂ , 3C0505223D
	<b>AU9037</b> SALINCAK ARKA ALT SAĞ SAC LEVHA	Ağırlık : 1,735 kg / 3.825 lb Malzeme Türü : Sac Metal	3C0505224E
	<b>AU9038</b> SALINCAK VE DENG KOLU ARKA ALT SOL SAC LEVHA	Ağırlık : 1,735 kg / 3.825 lb Malzeme Türü : Sac Metal	3C0505223E







\* Bu sayfada ve katalogdaki tüm araçların adları, markaları, modelleri, sembolleri, logoları, orjinal numaraları (oe) ve diğer üçüncü parti numaraları sadece referans amaçlı kullanılmaktadır.

**Q3**
**8U**
**2011 - 2016**

Resim	Ürün Kodu ve Açıklaması	Detay	OEM
	<b>VW6032</b> SALINCAK ÖN SAĞ RD1051	Ağırlık : 3,441 kg / 7.586 lb Malzeme Türü : Alüminyum	3C0407151A, 3C0407151B 3C0407151E, 3C0407151G*
	<b>VW6032J</b> SALINCAK ÖN RD1050	Ağırlık : 2,9 kg / 6.393 lb Malzeme Türü : Alüminyum	3C0407151A, 3C0407151B 3C0407151E, 3C0407151G 3C0407151H
	<b>VW6033</b> SALINCAK ÖN SOL RD1052	Ağırlık : 3,441 kg / 7.586 lb Malzeme Türü : Alüminyum	3C0407151A, 3C0407151B 3C0407151E, 3C0407151H*
	<b>VW9001</b> SALINCAK ARKA	Ağırlık : 2,55 kg / 5.622 lb Malzeme Türü : Sac Metal	1K0505311AA, 1K0505311ABÂ 1K0505311H, 1K0505311S 1K0505311T
	<b>VW9004</b> SALINCAK ARKA	Ağırlık : 1,3 kg / 2.866 lb Malzeme Türü : Sac Metal	5Q0505323C, 5Q0505323D
	<b>AU11014</b> SALINCAK VE DENGE KOLU BURCU ARKA SOL VE SAĞ	Şasi (Ön / Arka) : ARKA Yön : Sol Ve Sağ Ağırlık : 0.192 kg / 0.423 lb	1K0505543A
	<b>AU11035</b> SALINCAK VE DENGE KOLU BURCU ARKA SOL VE SAĞ	Şasi (Ön / Arka) : ARKA Yön : Sol Ve Sağ Ağırlık : 0,25 kg / 0.551 lb	1K0505171C
	<b>AU11088</b> SALINCAK VE DENGE KOLU BURCU ARKA	Şasi (Ön / Arka) : ARKA Ağırlık : 0,165 kg / 0.364 lb	1K0505541C, 1K0505541D 3C0505541
	<b>VW11037</b> SALINCAK VE DENGE KOLU BURCU SOL VE SAĞ	Yön : Sol Ve Sağ Ağırlık : 0.11 kg / 0.243 lb	1K0505279A
	<b>VW11042</b> SALINCAK VE DENGE KOLU BURCU ORTA SOL VE SAĞ	Yön : Orta Sol Ve Sağ Ağırlık : 0,182 kg / 0.401 lb	1K0407182, 5Q0407182
	<b>VW11046</b> SALINCAK VE DENGE KOLU BURCU SAĞ B40133	Yön : Sağ Ağırlık : 0,6 kg / 1.323 lb	3C0199231A, 3C0199231B 3C0199231D





\* Bu sayfada ve katalogdaki tüm araçların adları, markaları, modelleri, sembolleri, logoları, orjinal numaraları (oe) ve diğer üçüncü parti numaraları sadece referans amaçlı kullanılmaktadır.

**Q3**
**8U**
**2011 - 2016**

Resim	Ürün Kodu ve Açıklaması	Detay	OEM
	<b>VW11046B</b> SALINCAK VE DENGE KOLU BURCU SAĞ	Yön : Sağ Ağırlık : 0.445 kg / 0.981 lb Not : BURÇ GÖVDESİ	3C0199231A, 3C0199231B 3C0199231D
	<b>VW11180</b> Z-ROT BURCU ARKA	Şasi (Ön / Arka) : ARKA Ağırlık : 0.069 kg / 0.152 lb Uzunluk : VW4015 mm / 0.00 inch Aşık Dış Çapı : VW4015K	1K0505465C*, 1K0505465D* 1K0505465H*, 1K0505465J* 1K0505465K*
	<b>VW12159</b> TAŞIYICI DESTEK BURÇLARI ARKA SOL VE SAĞ	Şasi (Ön / Arka) : ARKA Yön : Sol Ve Sağ Ağırlık : 0,130 kg / 0.287 lb	1K0505553, 1K0505553A
	<b>AU12024</b> TORSİYON BURCU ARKA SOL VE SAĞ	Şasi (Ön / Arka) : ARKA Yön : Sol Ve Sağ Ağırlık : 0.557 kg / 1.228 lb	1K0505145F, 1K0505145H 1K0505145K
	<b>SK12003</b> VİRAJ DEMİR LASTİĞİ SOL VE SAĞ RUBBER	Şasi (Ön / Arka) : ÖN Yön : Sol Ve Sağ Ağırlık : 0,075 kg / 0.165 lb Malzeme Türü : Rubber	1K0411303, 1K0411303AL* 1K0411303BK, 1K0411314 3C0411303AA*, 3C0411303T*
	<b>SK12003K</b> VİRAJ DEMİR LASTİĞİ SOL VE SAĞ RUBBER	Şasi (Ön / Arka) : ÖN Yön : Sol Ve Sağ Ağırlık : 0,150 kg / 0.331 lb Malzeme Türü : Rubber	1K0411303, 1K0411303AL* 1K0411303BK, 1K0411314 3C0411303AA*, 3C0411303T*
	<b>VW12017</b> AMORTİSÖR TAKOZU SOL VE SAĞ AMORTİSÖR TAKOZU	Yön : Sol Ve Sağ Ağırlık : 0.847 kg / 1.867 lb Not : AMORTİSÖR TAKOZU	1K0412331B, 1K0412331C
	<b>VW12109</b> AMORTİSÖR TAKOZU SOL VE SAĞ AMORTİSÖR RULMANI	Yön : Sol Ve Sağ Ağırlık : 0.26 kg / 0.573 lb Not : AMORTİSÖR RULMANI	6N0412249C, 6N0412249E
	<b>VW12109K</b> AMORTİSÖR TAKOZU SOL VE SAĞ 2 PCS	Yön : Sol Ve Sağ Ağırlık : 0.52 kg / 1.146 lb Not : 2 PCS	6N0412249C, 6N0412249E
	<b>VW12105</b> MOTOR TAKOZU SOL VE SAĞ MOTOR TAKOZU ARKA	Yön : Sol Ve Sağ Ağırlık : 0.564 kg / 1.243 lb Not : MOTOR TAKOZU ARKA	3C0199855, 3C0199855H 3C0199855M
	<b>AU12042</b> SÜSPANSİYON TAKOZU ARKA	Şasi (Ön / Arka) : ARKA Ağırlık : 0,095 kg / 0.209 lb	5N0412303C

\* Bu sayfada ve katalogdaki tüm araçların adları, markaları, modelleri, sembolleri, logoları, orijinal numaraları (oe) ve diğer üçüncü parti numaraları sadece referans amaçlı kullanılmaktadır.

**Q3 8U 2011 - 2016**

Resim	Ürün Kodu ve Açıklaması	Detay	OEM
	<b>VW13006</b> DİREKSİYON KÖRÜĞÜ	Ağırlık : 0.145 kg / 0.320 lb	1K0423831A, 5C0423831
	<b>VW13006K</b> DİREKSİYON KÖRÜĞÜ SOL VE SAĞ 2 PİECES	Ağırlık : 0.29 kg / 0.639 lb	1K0423831A, 5C0423831
	<b>VW14003</b> AKS KÖRÜĞÜ +KELEPÇE+YAĞ. DIŞ	Ağırlık : 0.25 kg / 0.551 lb	1K0 498 203, 1K0498203
	<b>AU15001</b> AMORTİSÖR KÖRÜĞÜ ÖN	Şasi (Ön / Arka) : ÖN Ağırlık : 0,110 kg / 0.243 lb	6N0413175A

**Q3 F3B 2018 -**

Resim	Ürün Kodu ve Açıklaması	Detay	OEM
	<b>VW1019</b> ROTİL ÖN SAĞ Ø15,3 RB2538	Ağırlık : 0,555 kg / 1.224 lb Konik Ölçüsü : Ø15,3 Bağlantı Delik Çapı : Ø10,5 Aşık Diş Çapı : M12X1,5	3C0407366A
	<b>VW1020</b> ROTİL ÖN SOL Ø15,3 RB2539	Ağırlık : 0,555 kg / 1.224 lb Konik Ölçüsü : Ø15,3 Bağlantı Delik Çapı : Ø10,5 Aşık Diş Çapı : M12X1,5	3C0407365A
	<b>VW2008</b> ROTBAŞI ÖN SAĞ RD0342	Ağırlık : 0,412 kg / 0.908 lb Uzunluk : 95 mm / 3.74 inch Gövde Diş Çapı : M16X1,5 Aşık Diş Çapı : M12X1,5 Aşık Konik Çapı : Ø12,7	1K0423812A, 1K0423812C 1K0423812E, 1K0423812G 1K0423812J, 1K0423812K 1KD423812A
	<b>VW2009</b> ROTBAŞI ÖN SOL RD0343	Ağırlık : 0,412 kg / 0.908 lb Uzunluk : 95 mm / 3.74 inch Gövde Diş Çapı : M16X1,5 Aşık Diş Çapı : M12X1,5 Aşık Konik Çapı : Ø13,5	1K0423811A, 1K0423811C 1K0423811E, 1K0423811G 1K0423811J, 1K0423811K 1KD423811A
	<b>VW3021</b> ROTMİLİ SAĞ-SOL	Ağırlık : 0,705 kg / 1.554 lb Uzunluk : 330 mm / 12.99 inch	561423810
	<b>VW4014</b> Z ROT ÖN SAĞ-SOL METAL 335 RB2935	Ağırlık : 0,46 kg / 1.014 lb Malzeme Türü : Metal Uzunluk : 335 mm / 13.19 inch Aşık Diş Çapı : M12X1,5	1K0411315B, 1K0411315D 1K0411315J, 1K0411315K 1K0411315R, 5Q0411315A 5Q0411315B







\* Bu sayfada ve katalogdaki tüm araçların adları, markaları, modelleri, sembolleri, logoları, orjinal numaraları (oe) ve diğer üçüncü parti numaraları sadece referans amaçlı kullanılmaktadır.

**Q3**
**F3B**
**2018 -**





Resim	Ürün Kodu ve Açıklaması	Detay	OEM
	<b>VW4031</b> Z ROT ARKA PLASTİK	Ağırlık : 0,15 kg / 0.331 lb Malzeme Türü : Plastik Uzunluk : 70 mm / 2.76 inch Aşık Diş Çapı : M10X1,5	5Q0505465A, 5Q0505465C
	<b>SK9002</b> SALINCAK ALT SOL VE SAĞ	Ağırlık : 2,914 kg / 6.424 lb Malzeme Türü : Sac Metal	3Q0505311C, 3Q0505311D 3Q0505311E
	<b>VW6055</b> SALINCAK ÖN ALT SAĞ	Ağırlık : 3,768 kg / 8.307 lb Malzeme Türü : Sac Metal	3Q0407152E*, 3Q0407152E 3Q0407152F*, 3Q0407152F 3Q0407154B*, 3Q0407154B
	<b>VW6055J</b> SALINCAK ÖN ALT SAĞ	Malzeme Türü : Sac Metal	3Q0407152E, 3Q0407152F 3Q0407154B
	<b>VW6056</b> SALINCAK ÖN ALT SOL	Ağırlık : 3,768 kg / 8.307 lb Malzeme Türü : Sac Metal	3Q0407151E*, 3Q0407151E 3Q0407151F*, 3Q0407151F 3Q0407153B*, 3Q0407153B
	<b>VW6056J</b> SALINCAK ÖN ALT SOL	Malzeme Türü : Sac Metal	3Q0407151E, 3Q0407151F 3Q0407153B
	<b>VW9004</b> SALINCAK ARKA	Ağırlık : 1,3 kg / 2.866 lb Malzeme Türü : Sac Metal	5Q0505323C, 5Q0505323D
	<b>VW9005</b> SALINCAK ARKA ALT ÖNDEN	Ağırlık : 0,566 kg / 1.248 lb Malzeme Türü : Sac Metal	5Q0501529C, 5Q0501529D 5Q0501529E, 5Q0501529F
	<b>VW9008</b> SALINCAK SAĞ	Ağırlık : 1,110 kg / 2.447 lb Malzeme Türü : Sac Metal	5QF505224C
	<b>VW9009</b> SALINCAK SOL	Ağırlık : 1,110 kg / 2.447 lb Malzeme Türü : Sac Metal	5QF505223C
	<b>SK11006</b> SALINCAK VE DENGE KOLU BURCU ARKA ALT	Şasi (Ön / Arka) : ARKA Yön : Alt Ağırlık : 0,125 kg / 0.276 lb	3Q0505311C*, 3Q0505311D* 3Q0505311E*, 5Q0505171B*

\* Bu sayfada ve katalogdaki tüm araçların adları, markaları, modelleri, sembolleri, logoları, orjinal numaraları (oe) ve diğer üçüncü parti numaraları sadece referans amaçlı kullanılmaktadır.











**Q3 F3B 2018 -**

Resim	Ürün Kodu ve Açıklaması	Detay	OEM
	<b>VW11037</b> SALINCAK VE DENGE KOLU BURCU SOL VE SAĞ	Yön : Sol Ve Sağ Ağırlık : 0.11 kg / 0.243 lb	1K0505279A
	<b>VW11042</b> SALINCAK VE DENGE KOLU BURCU ORTA SOL VE SAĞ	Yön : Orta Sol Ve Sağ Ağırlık : 0,182 kg / 0.401 lb	1K0407182, 5Q0407182
	<b>VW11056</b> SALINCAK VE DENGE KOLU BURCU ARKA SOL VE SAĞ	Şasi (Ön / Arka) : ARKA Yön : Sol Ve Sağ Ağırlık : 0.13 kg / 0.287 lb	1K0505203A, 1K0505323D 1K0505323G, 1K0505323H 1K0505323N, 5Q0505323C
	<b>VW11063</b> SALINCAK VE DENGE KOLU BURCU SOL VE SAĞ	Yön : Sol Ve Sağ Ağırlık : 0.34 kg / 0.750 lb	5Q0407183D, 5Q0407183E
	<b>VW11075</b> SALINCAK VE DENGE KOLU BURCU ARKA SOL VE SAĞ	Şasi (Ön / Arka) : ARKA Yön : Sol Ve Sağ Ağırlık : 0,870 kg / 1.918 lb Not : FORWARD and INNER	Part of 5Q0501529C, Part of 5Q0501529D Part of 5Q0501529E, Part of 5Q0501529F
	<b>VW11076</b> SALINCAK VE DENGE KOLU BURCU ARKA SOL VE SAĞ	Şasi (Ön / Arka) : ARKA Yön : Sol Ve Sağ Ağırlık : 0,870 kg / 1.918 lb Not : FORWARD and OUTER	Part of 5Q0501529C, Part of 5Q0501529D Part of 5Q0501529E, Part of 5Q0501529F

**Q5 80A 2018 -**











Resim	Ürün Kodu ve Açıklaması	Detay	OEM
	<b>AU1023</b> ROTİL ALT	Ağırlık : 0,505 kg / 1.113 lb	80A407689B
	<b>AU2027</b> ROTBAŞI ÖN SAĞ	Ağırlık : 0,812 kg / 1.790 lb Uzunluk : 216 mm / 8.50 inch Gövde Diş Çapı : M16X1,5 Aşık Diş Çapı : M14X1,5	8W0423812B, 8W0423812C
	<b>AU2028</b> ROTBAŞI ÖN SOL	Ağırlık : 0,812 kg / 1.790 lb Uzunluk : 216 mm / 8.50 inch Gövde Diş Çapı : M16X1,5 Aşık Diş Çapı : M14X1,5	8W0423811B, 8W0423811C
	<b>AU3013</b> ROTMİLİ ÖN SAĞ - SOL	Ağırlık : 0,565 kg / 1.246 lb Uzunluk : 237 mm / 9.33 inch Gövde Diş Çapı : M16X1,5 Aşık Diş Çapı : M16X1,5	4M0423810C

\* Bu sayfada ve katalogdaki tüm araçların adları, markaları, modelleri, sembolleri, logoları, orijinal numaraları (oe) ve diğer üçüncü parti numaraları sadece referans amaçlı kullanılmaktadır.









Q5	80A	2018 -	
Resim	Ürün Kodu ve Açıklaması	Detay	OEM
	<b>AU4035</b> Z ROT SOL VE SAĞ	Ağırlık : 0,281 kg / 0.619 lb Uzunluk : 174,5 mm / 6.87 inch	4N0505465F, 8W0505465B
	<b>AU5075</b> SALINCAK ÜST ARKA TARAF SAĞ	Ağırlık : 0.55 kg / 1.213 lb Malzeme Türü : Alüminyum	4M0407510B, 4M0407510C 80A407510A
	<b>AU5076</b> SALINCAK ÜST ARKA TARAF SOL	Ağırlık : 0.55 kg / 1.213 lb Malzeme Türü : Alüminyum	4M0407509B, 4M0407509C 80A407509A
	<b>AU5077</b> SALINCAK ÜST ÖN TARAF SAĞ	Ağırlık : 0.56 kg / 1.235 lb Malzeme Türü : Alüminyum	4M0407506B, 4M0407506C 80A407506A
	<b>AU5078</b> SALINCAK ÜST ÖN TARAF SOL	Ağırlık : 0.56 kg / 1.235 lb Malzeme Türü : Alüminyum	4M0407505B, 4M0407505C 80A407505A
	<b>AU5083</b> SALINCAK ÖN ALT ÖNDEN SAĞ	Ağırlık : 1,430 kg / 3.153 lb Malzeme Türü : Alüminyum	4K0407152, 4K0407152A 4K0407152B, 4K0407152C 80A407152A
	<b>AU5084</b> SALINCAK ÖN ALT ÖNDEN SOL	Ağırlık : 1,430 kg / 3.153 lb Malzeme Türü : Alüminyum	4K0407151, 4K0407151A 4K0407151B, 4K0407151C 80A407151A
	<b>AU5089</b> SALINCAK VE DENGE KOLU ÖN ALT ARKADAN SAĞ	Ağırlık : 2,545 kg / 5.611 lb Malzeme Türü : Alüminyum	80A407694B, 80A407694C 80A407694D, 80A407694E 80A407694G
	<b>AU5090</b> SALINCAK VE DENGE KOLU ÖN ALT ARKADAN SOL	Ağırlık : 2,545 kg / 5.611 lb Malzeme Türü : Alüminyum	80A407693B, 80A407693C 80A407693D, 80A407693E 80A407693G
	<b>AU9018</b> SALINCAK ARKA ARKADAN SAĞ	Ağırlık : 1,150 kg / 2.535 lb Malzeme Türü : Sac Metal	4M0501530N, 80A501530A
	<b>AU9019</b> SALINCAK ARKA ARKADAN SOL	Ağırlık : 1,150 kg / 2.535 lb Malzeme Türü : Sac Metal	4M0501529N, 80A501529A

\* Bu sayfada ve katalogdaki tüm araçların adları, markaları, modelleri, sembolleri, logoları, orjinal numaraları (oe) ve diğer üçüncü parti numaraları sadece referans amaçlı kullanılmaktadır.



Q5	80A	2018 -	
Resim	Ürün Kodu ve Açıklaması	Detay	OEM
	<b>AU9020</b> SALINCAK ARKA ALT ARKADAN SAĞ	Ağırlık : 0,708 kg / 1.561 lb Malzeme Türü : Sac Metal	4M0505292D, 80A505292
	<b>AU9021</b> SALINCAK ARKA ALT ARKADAN SOL	Ağırlık : 0,708 kg / 1.561 lb Malzeme Türü : Sac Metal	4M0505291D, 80A505291
	<b>AU9022</b> SALINCAK ARKA ALT ARKADAN	Ağırlık : 1,322 kg / 2.915 lb Malzeme Türü : Alüminyum	4M0501529L
	<b>AU9029</b> SALINCAK ARKA ALT ARKADAN	Ağırlık : 0,811 kg / 1.788 lb Malzeme Türü : Alüminyum	4M0505323G
	<b>AU9031</b> SALINCAK VE DENGE KOLU ARKA ÜST SAĞ ALÜMİNYUM	Ağırlık : 1,545 kg / 3.406 lb Malzeme Türü : Alüminyum	4K0505398A, 4M0505398L
	<b>AU9032</b> SALINCAK VE DENGE KOLU ARKA ÜST SOL ALÜMİNYUM	Ağırlık : 1,545 kg / 3.406 lb Malzeme Türü : Alüminyum	4K0505397A, 4M0505397L
	<b>AU9033</b> SALINCAK ARKA ÖNDEN SAĞ ALÜMİNYUM	Ağırlık : 0,945 kg / 2.083 lb Malzeme Türü : Alüminyum	4M0505292F
	<b>AU9034</b> SALINCAK VE DENGE KOLU ARKA ÖNDEN SOL ALÜMİNYUM	Ağırlık : 0,945 kg / 2.083 lb Malzeme Türü : Alüminyum	4M0505291F
	<b>AU9035</b> SALINCAK VE DENGE KOLU ARKA ÜST SAĞ SAC LEVHA	Ağırlık : 1,245 kg / 2.745 lb Malzeme Türü : Sac Metal	4N0505398A, 80A505398A
	<b>AU9036</b> SALINCAK VE DENGE KOLU ARKA ÜST SOL SAC LEVHA	Ağırlık : 1,245 kg / 2.745 lb Malzeme Türü : Sac Metal	4N0505397A, 80A505397A
	<b>AU11043</b> SALINCAK VE DENGE KOLU BURCU ÖN ALT ORTA SOL VE SAĞ B22137	Şasi (Ön / Arka) : ÖN Yön : Alt Orta Sol Ve Sağ Ağırlık : 0,1 kg / 0.220 lb	4E0407181B

\* Bu sayfada ve katalogdaki tüm araçların adları, markaları, modelleri, sembolleri, logoları, orjinal numaraları (oe) ve diğer üçüncü parti numaraları sadece referans amaçlı kullanılmaktadır.

Q5	80A	2018 -	
Resim	Ürün Kodu ve Açıklaması	Detay	OEM
	<b>AU11071</b> SALINCAK VE DENGE KOLU BURCU ARKA ALT	Şasi (Ön / Arka) : ARKA Yön : Alt Ağırlık : 0,250 kg / 0.551 lb	4M0501529L*, 4M0501529N* 4M0501530N*
	<b>AU11072</b> SALINCAK VE DENGE KOLU BURCU ARKA ALT	Şasi (Ön / Arka) : ARKA Yön : Alt Ağırlık : 0,250 kg / 0.551 lb	4M0501529L*, 4M0501529N* 4M0501530N*
	<b>AU11075</b> SALINCAK VE DENGE KOLU BURCU ÖN ÖN ALT ÖNDEN	Şasi (Ön / Arka) : ÖN Yön : Ön Alt Önden Ağırlık : 0,207 kg / 0.456 lb	4M0407151H*, 4M0407152H* 80A407151A*, 80A407152A*
	<b>AU11078</b> SALINCAK VE DENGE KOLU BURCU ARKA ARKA ÜST ARKADAN	Şasi (Ön / Arka) : ARKA Yön : Arka Üst Arkadan Ağırlık : 0,115 kg / 0.254 lb	8W0505397C*, 8W0505397F* 8W0505398C*, 8W0505398F*
	<b>AU11083</b> SALINCAK VE DENGE KOLU BURCU ARKA İÇ ÜST	Şasi (Ön / Arka) : ARKA Yön : İç Üst Ağırlık : 0,105 kg / 0.231 lb	8W0505323F*, 8W0505324F*
	<b>AU11092</b> SALINCAK VE DENGE KOLU BURCU ÖN ALT ARKADAN	Şasi (Ön / Arka) : ÖN Yön : Alt Arkadan Ağırlık : 0,515 kg / 1.135 lb	80A407693B*, 80A407693C* 80A407693D*, 80A407693E* 80A407693C*, 80A407694B* 80A407694C*, 80A407694D* 80A407694E*, 80A407694C*
	<b>AU11093</b> SALINCAK VE DENGE KOLU BURCU ARKA ÖNDEN	Şasi (Ön / Arka) : ARKA Yön : Önden Ağırlık : 0,115 kg / 0.254 lb	4M0505291F*, 4M0505292F*
	<b>AU11094</b> SALINCAK VE DENGE KOLU BURCU ARKA ÜST	Şasi (Ön / Arka) : ARKA Yön : Üst Ağırlık : 0,145 kg / 0.320 lb	4N0505397A*, 4N0505398A* 80A505397A*, 80A505398A*
	<b>AU12039</b> SÜSPANSİYON TAKOZU ÖN	Şasi (Ön / Arka) : ÖN Ağırlık : 0,075 kg / 0.165 lb	8K0412131E

Q5	8R	2009 - 2017	
Resim	Ürün Kodu ve Açıklaması	Detay	OEM
	<b>AU1016</b> ROTİL ÖN ALT SAĞ - SOL Ø13,8 RB2411	Ağırlık : 0,5 kg / 1.102 lb Konik Ölçüsü : Ø13,8 Aşık Dış Çapı : M12X1,5 Rotil Gövde Çapı : Ø42	8K0407689E, 8K0407689F 8K0407689G

\* Bu sayfada ve katalogdaki tüm araçların adları, markaları, modelleri, sembolleri, logoları, orjinal numaraları (oe) ve diğer üçüncü parti numaraları sadece referans amaçlı kullanılmaktadır.

**Q5**
**8R**
**2009 - 2017**

Resim	Ürün Kodu ve Açıklaması	Detay	OEM
	<b>AU1019</b> ROTİL ÖN ALT SAĞ - SOL Ø17	Ağırlık : 0,505 kg / 1.113 lb Konik Ölçüsü : Ø17 Aşık Diş Çapı : M14X1,5 Rotil Gövde Çapı : Ø42	4G0407689A, 4G0407689C 8W0407689B
	<b>AU2001</b> ROTBAŞI SAĞ	Ağırlık : 0,801 kg / 1.766 lb Uzunluk : 206 mm / 8.11 inch Gövde Diş Çapı : M16X1,5 Aşık Diş Çapı : M12X1,5 Aşık Konik Çapı : Ø14,6	8K0422818A, 8K0422818B
	<b>AU2002</b> ROTBAŞI SOL	Ağırlık : 0,801 kg / 1.766 lb Uzunluk : 206 mm / 8.11 inch Gövde Diş Çapı : M16X1,5 Aşık Diş Çapı : M12X1,5 Aşık Konik Çapı : Ø14,6	8K0422817A, 8K0422817B
	<b>AU2019</b> ROTBAŞI SAĞ M16X1,5 RHT	Ağırlık : 0,78 kg / 1.720 lb Uzunluk : 209 mm / 8.23 inch Gövde Diş Çapı : M16X1,5 Aşık Diş Çapı : M12X1,5 Aşık Konik Çapı : Ø14,7	4G0423812A
	<b>AU2020</b> ROTBAŞI SOL M16X1,5 RHT	Ağırlık : 0,78 kg / 1.720 lb Uzunluk : 209 mm / 8.23 inch Gövde Diş Çapı : M16X1,5 Aşık Diş Çapı : M12X1,5 Aşık Konik Çapı : Ø14,7	4G0423811A
	<b>AU3007</b> ROTMİLİ	Ağırlık : 0,484 kg / 1.067 lb Uzunluk : 225 mm / 8.86 inch Gövde Diş Çapı : M16X1,5 Aşık Diş Çapı : M16X1,5	8J0423810
	<b>AU20013007</b> ROT TAKIMI ÖN AKS SAĞ	Ağırlık : 1,29 kg / 2.844 lb Rotbaşı : AU2001 Rotmili : AU3007	
	<b>AU20023007</b> ROT TAKIMI ÖN AKS SOL	Ağırlık : 1,29 kg / 2.844 lb Rotbaşı : AU2002 Rotmili : AU3007	
	<b>AU4023</b> Z ROT SOL VE SAĞ PLASTİK RB2947	Ağırlık : 0,117 kg / 0.258 lb Malzeme Türü : Plastik Uzunluk : 62 mm / 2.44 inch	8K0505465E, 8K0505465G
	<b>AU4024</b> Z ROT ARKA SAĞ	Ağırlık : 0,508 kg / 1.120 lb Uzunluk : 282,5 mm / 11.12 inch	8K0501530K, 8K0501530N
	<b>AU4025</b> Z ROT ARKA SOL	Ağırlık : 0,508 kg / 1.120 lb Uzunluk : 282,5 mm / 11.12 inch	8K0501529K, 8K0501529N

\* Bu sayfada ve katalogdaki tüm araçların adları, markaları, modelleri, sembolleri, logoları, orjinal numaraları (oe) ve diğer üçüncü parti numaraları sadece referans amaçlı kullanılmaktadır.

Q5	8R	2009 - 2017	
Resim	Ürün Kodu ve Açıklaması	Detay	OEM
	<b>AU4026</b> Z ROT ÖN DENGE ROTU 170 RB2944	Ağırlık : 0,185 kg / 0.408 lb Malzeme Türü : Denge Rotu Uzunluk : 170 mm / 6.69 inch	8K0411317C, 8K0411317D 8K0411317E
	<b>AU4029</b> Z ROT ÖN	Ağırlık : 0,138 kg / 0.304 lb Uzunluk : 170 mm / 6.69 inch	8K0411317D, 8K0411317E
	<b>AU4030</b> Z ROT ÖN ALÜMİNYUM L=110	Ağırlık : 0,151 kg / 0.333 lb Malzeme Türü : Alüminyum Uzunluk : 110 mm / 4.33 inch	8K0411317B
	<b>AU4031</b> Z ROT ÖN ALÜMİNYUM L=170	Ağırlık : 0,201 kg / 0.443 lb Malzeme Türü : Alüminyum Uzunluk : 170 mm / 6.69 inch	4G0411317A, 4G0411317C 4M0411317
	<b>AU5031</b> SALINCAK ÖN ÜST SAĞ	Malzeme Türü : Alüminyum	8K0407506A
	<b>AU5032</b> SALINCAK ÖN ÜST SOL	Malzeme Türü : Alüminyum	8K0407505A
	<b>AU5033</b> SALINCAK ÖN ÜST SAĞ	Malzeme Türü : Alüminyum	8K0407510A
	<b>AU5034</b> SALINCAK ÖN ÜST SOL	Malzeme Türü : Alüminyum	8K0407509, 8K0407509A
	<b>AU5049</b> SALINCAK ÖN ALT SAĞ	Malzeme Türü : Alüminyum	8K0407152F, 8K0407152G
	<b>AU5050</b> SALINCAK ÖN ALT SOL	Malzeme Türü : Alüminyum	8K0407151F, 8K0407151G
	<b>AU5053</b> SALINCAK ÖN SAĞ	Malzeme Türü : Alüminyum	8K0407694S, 8K0407694T







\* Bu sayfada ve katalogdaki tüm araçların adları, markaları, modelleri, sembolleri, logoları, orjinal numaraları (oe) ve diğer üçüncü parti numaraları sadece referans amaçlı kullanılmaktadır.

**Q5**
**8R**
**2009 - 2017**





Resim	Ürün Kodu ve Açıklaması	Detay	OEM
	<b>AU5054</b> SALINCAK ÖN SOL	Malzeme Türü : Alüminyum	8K0407693Q, 8K0407693T
	<b>AU5062</b> SALINCAK ÖN ALT SAĞ	Ağırlık : 1,3 kg / 2.866 lb Malzeme Türü : Alüminyum	8K0407152B, 8K0407152C 8K0407152D, 8K0407152E
	<b>AU5063</b> SALINCAK ÖN ALT SOL	Ağırlık : 1,3 kg / 2.866 lb Malzeme Türü : Alüminyum	8K0407151D
	<b>AU5073</b> SALINCAK ÖN ALT SAĞ	Ağırlık : 2,330 kg / 5.137 lb Malzeme Türü : Alüminyum	8K0407694AD, 8K0407694Q 8K0407694S, 8R0407694B 8R0407694D, 9A740769403
	<b>AU5074</b> SALINCAK ÖN ALT SOL	Ağırlık : 2,330 kg / 5.137 lb Malzeme Türü : Alüminyum	8K0407693AD, 8K0407693Q 8K0407693S, 8R0407693B 8R0407693D, 9A740769303
	<b>AU9001</b> SALINCAK ARKA	Ağırlık : 0,546 kg / 1.204 lb Malzeme Türü : Sac Metal	8K0501529L
	<b>AU11032</b> SALINCAK VE DENGİ KOLU BURCU ÖN SOL VE SAĞ	Şasi (Ön / Arka) : ÖN Yön : Sol Ve Sağ Ağırlık : 0,17 kg / 0.375 lb Not : DENGİ KOLU BURCU	4D0407183L, 4F0407183A 4F0407183B, 4F0407183E
	<b>AU11036</b> SALINCAK VE DENGİ KOLU BURCU ÖN SOL VE SAĞ	Şasi (Ön / Arka) : ÖN Yön : Sol Ve Sağ Ağırlık : 0,25 kg / 0.551 lb Not : DENGİ KOLU BURCU	4H0407515, 8D0407515A 8K0407515, 8R0407515
	<b>AU11043</b> SALINCAK VE DENGİ KOLU BURCU ÖN ALT ORTA SOL VE SAĞ B22137	Şasi (Ön / Arka) : ÖN Yön : Alt Orta Sol Ve Sağ Ağırlık : 0,1 kg / 0.220 lb	4E0407181B
	<b>AU11045</b> SALINCAK VE DENGİ KOLU BURCU ÜST SOL VE SAĞ	Yön : Üst Sol Ve Sağ Ağırlık : 0,1 kg / 0.220 lb	4E0407515D, 8D0407515B 8K0407515
	<b>AU11054</b> SALINCAK VE DENGİ KOLU BURCU SOL VE SAĞ	Yön : Sol Ve Sağ Ağırlık : 0,172 kg / 0.379 lb Not : SALINCAK BURCU	8K0407151B*, 8K0407151B 8K0407152B*

\* Bu sayfada ve katalogdaki tüm araçların adları, markaları, modelleri, sembolleri, logoları, orjinal numaraları (oe) ve diğer üçüncü parti numaraları sadece referans amaçlı kullanılmaktadır.

**Q5 8R 2009 - 2017**











Resim	Ürün Kodu ve Açıklaması	Detay	OEM
	<b>AU11055</b> SALINCAK VE DENGEL KOLU BURCU ALT SOL VE SAĞ	Yön : Alt Sol Ve Sağ Ağırlık : 0,29 kg / 0.639 lb Not : SALINCAK BURCU	8K0407183A, 8K0407183B
	<b>AU11090</b> SALINCAK VE DENGEL KOLU BURCU ÖN ALT	Şasi (Ön / Arka) : ÖN Yön : Alt Ağırlık : 0,595 kg / 1.312 lb Not : HYDRAULIC	8K0407183D, 8K0407183F 8W0404693B
	<b>AU11025</b> Z-ROT BURCU ARKA SOL VE SAĞ	Şasi (Ön / Arka) : ARKA Yön : Sol Ve Sağ Ağırlık : 0.032 kg / 0.071 lb Uzunluk : AU4023 mm / 0.00 inch	8K0505465E*, 8K0505465G*
	<b>AU12048</b> ŞANZIMAN TAKOZU ARKA ORTA	Şasi (Ön / Arka) : ARKA Yön : Orta Ağırlık : 0,641 kg / 1.413 lb	8K0399151BF, 8K0399151CD 8K0399151DB
	<b>AU12044</b> SÜSPANSİYON TAKOZU ARKA	Şasi (Ön / Arka) : ARKA Ağırlık : 0,125 kg / 0.276 lb	4F0512131D, 4F0512131G
	<b>AU12045</b> SÜSPANSİYON TAKOZU ÖN	Şasi (Ön / Arka) : ÖN Ağırlık : 0,075 kg / 0.165 lb	8R0412131E

**Q7 4LB 2006 - 2016**

Resim	Ürün Kodu ve Açıklaması	Detay	OEM
	<b>VW2001</b> ROTBAŞI SAĞ RD0347	Ağırlık : 0,87 kg / 1.918 lb Uzunluk : 180 mm / 7.09 inch Gövde Diş Çapı : M14X2 Aşık Diş Çapı : M12X1,75 Aşık Konik Çapı : Ø13,2	7L0422818B, 7L0422818C 7L0422818D, 95534713220
	<b>VW2002</b> ROTBAŞI SOL RD0346	Ağırlık : 0,87 kg / 1.918 lb Uzunluk : 93 mm / 3.66 inch Gövde Diş Çapı : M16X1,5 Aşık Diş Çapı : M14X1,5 Aşık Konik Çapı : Ø16,6	7L0422817B, 7L0422817C 7L0422817D, 95534713221
	<b>VW3001</b> ROTMİLİ SAĞ-SOL 288 RD08226	Ağırlık : 0,692 kg / 1.526 lb Uzunluk : 288 mm / 11.34 inch Gövde Diş Çapı : M16X1,5 Aşık Diş Çapı : M16X1,5	1160310016, 7L0422803B 7L0422803C, 7L0422804B 7L0422804C, 7L0422821 7L0422821B, 7L0422821D
	<b>VW20013001</b> ROT TAKIMI ÖN AKS SAĞ	Ağırlık : 1,285 kg / 2.833 lb Rotbaşı : VW2001 Rotmilî : VW3001	7L0422804B, 7L0422804C 7L0422804D, 955347032021











\* Bu sayfada ve katalogdaki tüm araçların adları, markaları, modelleri, sembolleri, logoları, orijinal numaraları (oe) ve diğer üçüncü parti numaraları sadece referans amaçlı kullanılmaktadır.

**Q7 4LB 2006 - 2016**

Resim	Ürün Kodu ve Açıklaması	Detay	OEM
	<b>VW20023001</b> ROT TAKIMI ÖN AKS SOL	Ağırlık : 1,27 kg / 2.800 lb Rotbaşı : VW2002 Rotmili : VW3001	7L0422803B, 7L0422803C 7L0422803D, 955347032020
	<b>AU4042</b> Z ROT SAĞ METAL	Ağırlık : 0,533 kg / 1.175 lb Malzeme Türü : Metal Uzunluk : 200 mm / 7.87 inch Not : CHASSIS NO FROM 4L8030301	7L0505466C, 7L0505466D 95533307021
	<b>AU4043</b> Z ROT SOL METAL	Ağırlık : 0,533 kg / 1.175 lb Malzeme Türü : Metal Uzunluk : 200 mm / 7.87 inch Not : CHASSIS NO FROM 4L8030301	7L0505465C, 7L0505465D 95533306921
	<b>VW4002</b> Z ROT ARKA SAĞ 201 RD0943	Ağırlık : 0,535 kg / 1.179 lb Malzeme Türü : Metal Uzunluk : 201 mm / 7.91 inch Aşık Diş Çapı : M12X1,5	7L0505466A, 95533307010
	<b>VW4003</b> Z ROT ARKA SOL 201 RD0944	Ağırlık : 0,534 kg / 1.177 lb Malzeme Türü : Metal Uzunluk : 201 mm / 7.91 inch Aşık Diş Çapı : M12X1,5	7L0505465A, 7L0505465B 95533306910, 95533306921 95533307011
	<b>AU6011</b> SALINCAK ÖN ALT SAĞ RB3019	Ağırlık : 5,348 kg / 11.790 lb Malzeme Türü : Alüminyum	7L8407152D, 7L8407152E 7L8407152F, 7L8407152K 95834105400
	<b>AU6012</b> SALINCAK ÖN ALT SOL RB3020	Ağırlık : 5,348 kg / 11.790 lb Malzeme Türü : Alüminyum	7L8407151D, 7L8407151E 7L8407151F, 7L8407151K 95834105300
	<b>AU6015</b> SALINCAK ARKA ÜST SOL	Ağırlık : 1,09 kg / 2.403 lb Malzeme Türü : Alüminyum	7L0505397, 7L0505398
	<b>AU6016</b> SALINCAK ARKA ÜST SAĞ	Ağırlık : 1,09 kg / 2.403 lb Malzeme Türü : Alüminyum	7L0505397, 7L0505398
	<b>AU6021</b> SALINCAK ÖN SAĞ ALT	Ağırlık : 5,348 kg / 11.790 lb Malzeme Türü : Alüminyum	7P0407152B, 7P0407152C 7P0407152D, 7P0407152E 95834105403
	<b>AU6022</b> SALINCAK ÖN SOL ALT	Ağırlık : 5,348 kg / 11.790 lb Malzeme Türü : Alüminyum	7P0407151B, 7P0407151C 7P0407151D, 7P0407151E 95834105303

\* Bu sayfada ve katalogdaki tüm araçların adları, markaları, modelleri, sembolleri, logoları, orjinal numaraları (oe) ve diğer üçüncü parti numaraları sadece referans amaçlı kullanılmaktadır.





**Q7**
**4LB**
**2006 - 2016**

Resim	Ürün Kodu ve Açıklaması	Detay	OEM
	<b>AU6027</b> SALINCAK ÜST	Ağırlık : 1,255 kg / 2.767 lb Malzeme Türü : Alüminyum	7L8407021
	<b>AU9005</b> SALINCAK ARKA	Ağırlık : 1,36 kg / 2.998 lb Malzeme Türü : Sac Metal	7L8501529, 7L8501529A 95533104530, 95533104531 95533104532
	<b>VW5003</b> SALINCAK ÖN	Ağırlık : 0,230 kg / 0.507 lb Malzeme Türü : Alüminyum	7L0411317, 95534306900
	<b>VW5004</b> SALINCAK ARKA ÜST	Ağırlık : 0,860 kg / 1.896 lb Malzeme Türü : Alüminyum	7L0505323A, 95533104710
	<b>VW6027</b> SALINCAK ÖN ÜST RB3017	Ağırlık : 1,1 kg / 2.425 lb Malzeme Türü : Alüminyum	7L0407021, 7L0407021A 7L0407021B, 95534102701 95534102702
	<b>VW6067</b> SALINCAK ALT SAĞ	Ağırlık : 8,834 kg / 19.476 lb Malzeme Türü : Döküm Çelik	7L0407152F, 7L0407152J 7L0407152K, 95534101860 95534101861
	<b>VW6068</b> SALINCAK ALT SOL	Ağırlık : 8,834 kg / 19.476 lb Malzeme Türü : Döküm Çelik	7L0407151F, 7L0407151J 7L0407151K, 95534101760 95534101761
	<b>AU11020</b> SALINCAK VE DENGE KOLU BURCU ÖN ALT SOL VE SAĞ	Şasi (Ön / Arka) : ÖN Yön : Alt Sol Ve Sağ Ağırlık : 0,22 kg / 0.485 lb	7L0407183, 7L0407183A 95534158810
	<b>AU11026</b> SALINCAK VE DENGE KOLU BURCU ÖN ORTA SOL VE SAĞ	Şasi (Ön / Arka) : ÖN Yön : Orta Sol Ve Sağ Ağırlık : 0,272 kg / 0.600 lb	7L0412333A
	<b>AU11037</b> SALINCAK VE DENGE KOLU BURCU ARKA SOL VE SAĞ	Şasi (Ön / Arka) : ARKA Yön : Sol Ve Sağ Ağırlık : 0,222 kg / 0.489 lb Not : DENGE KOLU BURCU	7L8501529A-P
	<b>AU11063</b> SALINCAK VE DENGE KOLU BURCU SOL VE SAĞ	Yön : Sol Ve Sağ Ağırlık : 0.18 kg / 0.397 lb	7L0505397*, 7L0505398* part of 7L0505397

\* Bu sayfada ve katalogdaki tüm araçların adları, markaları, modelleri, sembolleri, logoları, orjinal numaraları (oe) ve diğer üçüncü parti numaraları sadece referans amaçlı kullanılmaktadır.



**Q7**
**4LB**
**2006 - 2016**



Resim	Ürün Kodu ve Açıklaması	Detay	OEM
	<b>AU11064</b> SALINCAK VE DENGE KOLU BURCU SOL VE SAĐ	Yön : Sol Ve SaĐ AĐırlık : 0.278 kg / 0.613 lb	7L0501537B, 7L0505397* 7L0505397, 7L0505397SK 7L0505398*, 7L0505398 7L0505398SK, 7L8501529A 7L8501529ASK, part of 7L0505397
	<b>AU11067</b> SALINCAK VE DENGE KOLU BURCU ARKA SOL VE SAĐ	Şasi (Ön / Arka) : ARKA Yön : Sol Ve SaĐ Not : DENGE KOLU BURCU	7L8501529A-P
	<b>VW11026</b> SALINCAK VE DENGE KOLU BURCU SOL VE SAĐ	Yön : Sol Ve SaĐ AĐırlık : 0,25 kg / 0.551 lb	7L0407182C, 7L0407182E 95534124203
	<b>VW11032</b> SALINCAK VE DENGE KOLU BURCU SOL VE SAĐ	Yön : Sol Ve SaĐ AĐırlık : 0.34 kg / 0.750 lb	7L0407182D, 7L0407182F 7L0407182G
	<b>VW11038</b> SALINCAK VE DENGE KOLU BURCU ÜST SOL VE SAĐ	Yön : Üst Sol Ve SaĐ AĐırlık : 0.16 kg / 0.353 lb Not : ARKA DENGE KOL BURCU DÜZ	7L0505323A, 7L0505553
	<b>VW11039</b> SALINCAK VE DENGE KOLU BURCU ARKA SOL VE SAĐ	Şasi (Ön / Arka) : ARKA Yön : Sol Ve SaĐ AĐırlık : 0.12 kg / 0.265 lb Not : ARKA DENGE KOL BURCU 12MM	7L0505554
	<b>VW11048</b> SALINCAK VE DENGE KOLU BURCU SOL VE SAĐ	Yön : Sol Ve SaĐ AĐırlık : 0,262 kg / 0.578 lb	7L0411317 (p), 7L0411317-P
	<b>VW11061</b> SALINCAK VE DENGE KOLU BURCU ÜST SOL VE SAĐ	Yön : Üst Sol Ve SaĐ AĐırlık : 0,178 kg / 0.392 lb	7L0407021A, 7L0407021B 7L0407077
	<b>AU12030</b> MOTOR TAKOZU ÖN	Şasi (Ön / Arka) : ÖN AĐırlık : 1,510 kg / 3.329 lb	7L8199131, 7L8199131A 95537504900
	<b>AU12047</b> ŞANZIMAN TAKOZU ARKA	Şasi (Ön / Arka) : ARKA AĐırlık : 0,473 kg / 1.043 lb	7L0399249B, 7L6399225F 7L6399225Q
	<b>AU12036</b> SÜSPANSİYON TAKOZU ARKA	Şasi (Ön / Arka) : ARKA AĐırlık : 0,135 kg / 0.298 lb	7L0512131B, 95533310520

\* Bu sayfada ve katalogdaki tüm araçların adları, markaları, modelleri, sembolleri, logoları, orjinal numaraları (oe) ve diĐer üçüncü parti numaraları sadece referans amaçlı kullanılmaktadır.











**Q7 4LB 2006 - 2016**

Resim	Ürün Kodu ve Açıklaması	Detay	OEM
	<b>RN14016</b> AKS KÖRÜĞÜ +KELEPÇE+YAĞ. DIŞ	Ağırlık : 0.26 kg / 0.573 lb	7701209568, 7H0498103E 7H0498202A

**Q7 4MB 2015 -**











Resim	Ürün Kodu ve Açıklaması	Detay	OEM
	<b>AU1022</b> ROTİL ÖN ALT ÖNDEN	Ağırlık : 0,580 kg / 1.279 lb	4M0407689B, 4M0407689C
	<b>AU2029</b> ROTBAŞI ÖN SAĞ	Ağırlık : 0,890 kg / 1.962 lb Uzunluk : 221 mm / 8.70 inch	4M0423812B, 4M0423812D
	<b>AU2030</b> ROTBAŞI SOL	Ağırlık : 0,890 kg / 1.962 lb Uzunluk : 221 mm / 8.70 inch	4M0423811B, 4M0423811D
	<b>AU3013</b> ROTMİLİ ÖN SAĞ - SOL	Ağırlık : 0,565 kg / 1.246 lb Uzunluk : 237 mm / 9.33 inch Gövde Diş Çapı : M16X1,5 Aşık Diş Çapı : M16X1,5	4M0423810C
	<b>AU4031</b> Z ROT ÖN ALÜMİNYUM L=170	Ağırlık : 0,201 kg / 0.443 lb Malzeme Türü : Alüminyum Uzunluk : 170 mm / 6.69 inch	4G0411317A, 4G0411317C 4M0411317
	<b>AU4032</b> Z ROT ÖN SAĞ - SOL	Ağırlık : 0,506 kg / 1.116 lb Uzunluk : 174 mm / 6.85 inch Not : ACTIVE SUSPENSION	4M0411317E, 4M0411317F
	<b>AU4033</b> Z ROT ARKA SAĞ - SOL ALÜMİNYUM	Ağırlık : 0,320 kg / 0.705 lb Malzeme Türü : Alüminyum Uzunluk : 174 mm / 6.85 inch	4M0505465D
	<b>VW4002</b> Z ROT ARKA SAĞ 201 RD0943	Ağırlık : 0,535 kg / 1.179 lb Malzeme Türü : Metal Uzunluk : 201 mm / 7.91 inch Aşık Diş Çapı : M12X1,5	7L0505466A, 95533307010
	<b>VW4003</b> Z ROT ARKA SOL 201 RD0944	Ağırlık : 0,534 kg / 1.177 lb Malzeme Türü : Metal Uzunluk : 201 mm / 7.91 inch Aşık Diş Çapı : M12X1,5	7L0505465A, 7L0505465B 95533306910, 95533306921 95533307011

\* Bu sayfada ve katalogdaki tüm araçların adları, markaları, modelleri, sembolleri, logoları, orjinal numaraları (oe) ve diğer üçüncü parti numaraları sadece referans amaçlı kullanılmaktadır.

Q7	4MB	2015 -	
Resim	Ürün Kodu ve Açıklaması	Detay	OEM
	<b>AU5075</b> SALINCAK ÜST ARKA TARAF SAĞ	Ağırlık : 0.55 kg / 1.213 lb Malzeme Türü : Alüminyum	4M0407510B, 4M0407510C 80A407510A
	<b>AU5076</b> SALINCAK ÜST ARKA TARAF SOL	Ağırlık : 0.55 kg / 1.213 lb Malzeme Türü : Alüminyum	4M0407509B, 4M0407509C 80A407509A
	<b>AU5077</b> SALINCAK ÜST ÖN TARAF SAĞ	Ağırlık : 0.56 kg / 1.235 lb Malzeme Türü : Alüminyum	4M0407506B, 4M0407506C 80A407506A
	<b>AU5078</b> SALINCAK ÜST ÖN TARAF SOL	Ağırlık : 0.56 kg / 1.235 lb Malzeme Türü : Alüminyum	4M0407505B, 4M0407505C 80A407505A
	<b>AU5079</b> SALINCAK ALT ÖN TARAF SAĞ	Ağırlık : 1,527 kg / 3.366 lb Malzeme Türü : Alüminyum	4M0407152D, 4M0407152F 4M0407152H
	<b>AU5080</b> SALINCAK ALT ÖN TARAF SOL	Ağırlık : 1,527 kg / 3.366 lb Malzeme Türü : Alüminyum	4M0407151D, 4M0407151F 4M0407151H
	<b>AU5081</b> SALINCAK ÜST ARKA TARAF SAĞ	Ağırlık : 3,143 kg / 6.929 lb Malzeme Türü : Alüminyum	4M0407694C, 4M0407694D 4M0407694E, 95840769400
	<b>AU5082</b> SALINCAK ÜST ARKA TARAF SOL	Ağırlık : 3,143 kg / 6.929 lb Malzeme Türü : Alüminyum	4M0407693C, 4M0407693D 4M0407693E, 95840769300
	<b>AU9018</b> SALINCAK ARKA ARKADAN SAĞ	Ağırlık : 1,150 kg / 2.535 lb Malzeme Türü : Sac Metal	4M0501530N, 80A501530A
	<b>AU9019</b> SALINCAK ARKA ARKADAN SOL	Ağırlık : 1,150 kg / 2.535 lb Malzeme Türü : Sac Metal	4M0501529N, 80A501529A
	<b>AU9020</b> SALINCAK ARKA ALT ARKADAN SAĞ	Ağırlık : 0,708 kg / 1.561 lb Malzeme Türü : Sac Metal	4M0505292D, 80A505292



\* Bu sayfada ve katalogdaki tüm araçların adları, markaları, modelleri, sembolleri, logoları, orjinal numaraları (oe) ve diğer üçüncü parti numaraları sadece referans amaçlı kullanılmaktadır.

**Q7**
**4MB**
**2015 -**

Resim	Ürün Kodu ve Açıklaması	Detay	OEM
	<b>AU9021</b> SALINCAK ARKA ALT ARKADAN SOL	Ağırlık : 0,708 kg / 1.561 lb Malzeme Türü : Sac Metal	4M0505291D, 80A505291
	<b>AU9022</b> SALINCAK ARKA ALT ARKADAN	Ağırlık : 1,322 kg / 2.915 lb Malzeme Türü : Alüminyum	4M0501529L
	<b>AU9029</b> SALINCAK ARKA ALT ARKADAN	Ağırlık : 0,811 kg / 1.788 lb Malzeme Türü : Alüminyum	4M0505323G
	<b>AU9031</b> SALINCAK VE DENGE KOLU ARKA ÜST SAĞ ALÜMİNYUM	Ağırlık : 1,545 kg / 3.406 lb Malzeme Türü : Alüminyum	4K0505398A, 4M0505398L
	<b>AU9032</b> SALINCAK VE DENGE KOLU ARKA ÜST SOL ALÜMİNYUM	Ağırlık : 1,545 kg / 3.406 lb Malzeme Türü : Alüminyum	4K0505397A, 4M0505397L
	<b>AU9033</b> SALINCAK ARKA ÖNDEN SAĞ ALÜMİNYUM	Ağırlık : 0,945 kg / 2.083 lb Malzeme Türü : Alüminyum	4M0505292F
	<b>AU9034</b> SALINCAK VE DENGE KOLU ARKA ÖNDEN SOL ALÜMİNYUM	Ağırlık : 0,945 kg / 2.083 lb Malzeme Türü : Alüminyum	4M0505291F
	<b>VW6027</b> SALINCAK ÖN ÜST RB3017	Ağırlık : 1,1 kg / 2.425 lb Malzeme Türü : Alüminyum	7L0407021, 7L0407021A 7L0407021B, 95534102701 95534102702
	<b>AU11071</b> SALINCAK VE DENGE KOLU BURCU ARKA ALT	Şasi (Ön / Arka) : ARKA Yön : Alt Ağırlık : 0,250 kg / 0.551 lb	4M0501529L*, 4M0501529N* 4M0501530N*
	<b>AU11072</b> SALINCAK VE DENGE KOLU BURCU ARKA ALT	Şasi (Ön / Arka) : ARKA Yön : Alt Ağırlık : 0,250 kg / 0.551 lb	4M0501529L*, 4M0501529N* 4M0501530N*
	<b>AU11073</b> SALINCAK VE DENGE KOLU BURCU ÖN ÜST	Şasi (Ön / Arka) : ÖN Yön : Üst Ağırlık : 0,620 kg / 1.367 lb	4M0407693C, 4M0407693D 4M0407693E, 4M0407694C 4M0407694D, 4M0407694E 95840769300, 95840769400

\* Bu sayfada ve katalogdaki tüm araçların adları, markaları, modelleri, sembolleri, logoları, orjinal numaraları (oe) ve diğer üçüncü parti numaraları sadece referans amaçlı kullanılmaktadır.









**Q7 4MB 2015 -**

Resim	Ürün Kodu ve Açıklaması	Detay	OEM
	<b>AU11075</b> SALINCAK VE DENGE KOLU BURCU ÖN ÖN ALT ÖNDEN	Şasi (Ön / Arka) : ÖN Yön : Ön Alt Önden Ağırlık : 0,207 kg / 0.456 lb	4M0407151H*, 4M0407152H* 80A407151A*, 80A407152A*
	<b>AU11076</b> SALINCAK VE DENGE KOLU BURCU ÖN ÖN ALT ÖNDEN	Şasi (Ön / Arka) : ÖN Yön : Ön Alt Önden Ağırlık : 0,145 kg / 0.320 lb	4M0407151H*, 4M0407152H*
	<b>AU11078</b> SALINCAK VE DENGE KOLU BURCU ARKA ARKA ÜST ARKADAN	Şasi (Ön / Arka) : ARKA Yön : Arka Üst Arkadan Ağırlık : 0,115 kg / 0.254 lb	8W0505397C*, 8W0505397F* 8W0505398C*, 8W0505398F*
	<b>AU11083</b> SALINCAK VE DENGE KOLU BURCU ARKA İÇ ÜST	Şasi (Ön / Arka) : ARKA Yön : İç Üst Ağırlık : 0,105 kg / 0.231 lb	8W0505323F*, 8W0505324F*
	<b>AU11093</b> SALINCAK VE DENGE KOLU BURCU ARKA ÖNDEN	Şasi (Ön / Arka) : ARKA Yön : Önden Ağırlık : 0,115 kg / 0.254 lb	4M0505291F*, 4M0505292F*
	<b>VW11032</b> SALINCAK VE DENGE KOLU BURCU SOL VE SAĞ	Yön : Sol Ve Sağ Ağırlık : 0.34 kg / 0.750 lb	7L0407182D, 7L0407182F 7L0407182G
	<b>VW11061</b> SALINCAK VE DENGE KOLU BURCU ÜST SOL VE SAĞ	Yön : Üst Sol Ve Sağ Ağırlık : 0,178 kg / 0.392 lb	7L0407021A, 7L0407021B 7L0407077
	<b>AU12046</b> ŞANZIMAN TAKOZU	Ağırlık : 1,156 kg / 2.549 lb	4G0399153T, 4M0399153AE











**Q8 4MN 2019 -**

Resim	Ürün Kodu ve Açıklaması	Detay	OEM
	<b>AU2029</b> ROTBAŞI ÖN SAĞ	Ağırlık : 0,890 kg / 1.962 lb Uzunluk : 221 mm / 8.70 inch	4M0423812B, 4M0423812D
	<b>AU2030</b> ROTBAŞI SOL	Ağırlık : 0,890 kg / 1.962 lb Uzunluk : 221 mm / 8.70 inch	4M0423811B, 4M0423811D

\* Bu sayfada ve katalogdaki tüm araçların adları, markaları, modelleri, sembolleri, logoları, orjinal numaraları (oe) ve diğer üçüncü parti numaraları sadece referans amaçlı kullanılmaktadır.







Q8	4MN	2019 -	
Resim	Ürün Kodu ve Açıklaması	Detay	OEM
	<b>AU3013</b> ROTMİLİ ÖN SAĞ - SOL	Ağırlık : 0,565 kg / 1.246 lb Uzunluk : 237 mm / 9.33 inch Gövde Diş Çapı : M16X1,5 Aşık Diş Çapı : M16X1,5	4M0423810C
	<b>AU4031</b> Z ROT ÖN ALÜMİNYUM L=170	Ağırlık : 0,201 kg / 0.443 lb Malzeme Türü : Alüminyum Uzunluk : 170 mm / 6.69 inch	4G0411317A, 4G0411317C 4M0411317
	<b>AU4032</b> Z ROT ÖN SAĞ - SOL	Ağırlık : 0,506 kg / 1.116 lb Uzunluk : 174 mm / 6.85 inch Not : ACTIVE SUSPENSION	4M0411317E, 4M0411317F
	<b>AU4033</b> Z ROT ARKA SAĞ - SOL ALÜMİNYUM	Ağırlık : 0,320 kg / 0.705 lb Malzeme Türü : Alüminyum Uzunluk : 174 mm / 6.85 inch	4M0505465D
	<b>AU5077</b> SALINCAK ÜST ÖN TARAF SAĞ	Ağırlık : 0.56 kg / 1.235 lb Malzeme Türü : Alüminyum	4M0407506B, 4M0407506C 80A407506A
	<b>AU5078</b> SALINCAK ÜST ÖN TARAF SOL	Ağırlık : 0.56 kg / 1.235 lb Malzeme Türü : Alüminyum	4M0407505B, 4M0407505C 80A407505A
	<b>AU5079</b> SALINCAK ALT ÖN TARAF SAĞ	Ağırlık : 1,527 kg / 3.366 lb Malzeme Türü : Alüminyum	4M0407152D, 4M0407152F 4M0407152H
	<b>AU5080</b> SALINCAK ALT ÖN TARAF SOL	Ağırlık : 1,527 kg / 3.366 lb Malzeme Türü : Alüminyum	4M0407151D, 4M0407151F 4M0407151H
	<b>AU5081</b> SALINCAK ÜST ARKA TARAF SAĞ	Ağırlık : 3,143 kg / 6.929 lb Malzeme Türü : Alüminyum	4M0407694C, 4M0407694D 4M0407694E, 95840769400
	<b>AU5082</b> SALINCAK ÜST ARKA TARAF SOL	Ağırlık : 3,143 kg / 6.929 lb Malzeme Türü : Alüminyum	4M0407693C, 4M0407693D 4M0407693E, 95840769300
	<b>AU9018</b> SALINCAK ARKA ARKADAN SAĞ	Ağırlık : 1,150 kg / 2.535 lb Malzeme Türü : Sac Metal	4M0501530N, 80A501530A

\* Bu sayfada ve katalogdaki tüm araçların adları, markaları, modelleri, sembolleri, logoları, orjinal numaraları (oe) ve diğer üçüncü parti numaraları sadece referans amaçlı kullanılmaktadır.

Q8	4MN	2019 -	
Resim	Ürün Kodu ve Açıklaması	Detay	OEM
	<b>AU9019</b> SALINCAK ARKA ARKADAN SOL	Ağırlık : 1,150 kg / 2.535 lb Malzeme Türü : Sac Metal	4M0501529N, 80A501529A
	<b>AU9022</b> SALINCAK ARKA ALT ARKADAN	Ağırlık : 1,322 kg / 2.915 lb Malzeme Türü : Alüminyum	4M0501529L
	<b>AU9029</b> SALINCAK ARKA ALT ARKADAN	Ağırlık : 0,811 kg / 1.788 lb Malzeme Türü : Alüminyum	4M0505323G
	<b>AU9031</b> SALINCAK VE DENGE KOLU ARKA ÜST SAĞ ALÜMİNYUM	Ağırlık : 1,545 kg / 3.406 lb Malzeme Türü : Alüminyum	4K0505398A, 4M0505398L
	<b>AU9032</b> SALINCAK VE DENGE KOLU ARKA ÜST SOL ALÜMİNYUM	Ağırlık : 1,545 kg / 3.406 lb Malzeme Türü : Alüminyum	4K0505397A, 4M0505397L
	<b>AU9033</b> SALINCAK ARKA ÖNDEN SAĞ ALÜMİNYUM	Ağırlık : 0,945 kg / 2.083 lb Malzeme Türü : Alüminyum	4M0505292F
	<b>AU9034</b> SALINCAK VE DENGE KOLU ARKA ÖNDEN SOL ALÜMİNYUM	Ağırlık : 0,945 kg / 2.083 lb Malzeme Türü : Alüminyum	4M0505291F
	<b>AU11071</b> SALINCAK VE DENGE KOLU BURCU ARKA ALT	Şasi (Ön / Arka) : ARKA Yön : Alt Ağırlık : 0,250 kg / 0.551 lb	4M0501529L*, 4M0501529N* 4M0501530N*
	<b>AU11072</b> SALINCAK VE DENGE KOLU BURCU ARKA ALT	Şasi (Ön / Arka) : ARKA Yön : Alt Ağırlık : 0,250 kg / 0.551 lb	4M0501529L*, 4M0501529N* 4M0501530N*
	<b>AU11073</b> SALINCAK VE DENGE KOLU BURCU ÖN ÜST	Şasi (Ön / Arka) : ÖN Yön : Üst Ağırlık : 0,620 kg / 1.367 lb	4M0407693C, 4M0407693D 4M0407693E, 4M0407694C 4M0407694D, 4M0407694E 95840769300, 95840769400
	<b>AU11075</b> SALINCAK VE DENGE KOLU BURCU ÖN ÖN ALT ÖNDEN	Şasi (Ön / Arka) : ÖN Yön : Ön Alt Önden Ağırlık : 0,207 kg / 0.456 lb	4M0407151H*, 4M0407152H* 80A407151A*, 80A407152A*











\* Bu sayfada ve katalogdaki tüm araçların adları, markaları, modelleri, sembolleri, logoları, orjinal numaraları (oe) ve diğer üçüncü parti numaraları sadece referans amaçlı kullanılmaktadır.

Q8	4MN	2019 -	
Resim	Ürün Kodu ve Açıklaması	Detay	OEM
	<b>AU11076</b> SALINCAK VE DENGE KOLU BURCU ÖN ÖN ALT ÖNDEN	Şasi (Ön / Arka) : ÖN Yön : Ön Alt Önden Ağırlık : 0,145 kg / 0.320 lb	4M0407151H*, 4M0407152H*
	<b>AU11078</b> SALINCAK VE DENGE KOLU BURCU ARKA ARKA ÜST ARKADAN	Şasi (Ön / Arka) : ARKA Yön : Arka Üst Arkadan Ağırlık : 0,115 kg / 0.254 lb	8W0505397C*, 8W0505397F* 8W0505398C*, 8W0505398F*
	<b>AU11083</b> SALINCAK VE DENGE KOLU BURCU ARKA İÇ ÜST	Şasi (Ön / Arka) : ARKA Yön : İç Üst Ağırlık : 0,105 kg / 0.231 lb	8W0505323F*, 8W0505324F*
	<b>AU11093</b> SALINCAK VE DENGE KOLU BURCU ARKA ÖNDEN	Şasi (Ön / Arka) : ARKA Yön : Önden Ağırlık : 0,115 kg / 0.254 lb	4M0505291F*, 4M0505292F*











TT	8J3	2006 - 2014	
Resim	Ürün Kodu ve Açıklaması	Detay	OEM
	<b>AU1017</b> ROTİL SAĞ	Ağırlık : 0,612 kg / 1.349 lb	8J0407366
	<b>AU1017K</b> ROTİL SAĞ	Ağırlık : 0,712 kg / 1.570 lb	8J0407366
	<b>AU1018</b> ROTİL SOL	Ağırlık : 0,612 kg / 1.349 lb	8J0407365
	<b>AU1018K</b> ROTİL SOL	Ağırlık : 0,712 kg / 1.570 lb	8J0407365
	<b>AU2023</b> ROTBAŞI SAĞ M16X1,5	Ağırlık : 0,76 kg / 1.676 lb Uzunluk : 200 mm / 7.87 inch Gövde Diş Çapı : M16X1,5 Aşık Diş Çapı : M12X1,5 Aşık Konik Çapı : Ø14,6	8J0423812
	<b>AU2024</b> ROTBAŞI SOL M16X1,5	Ağırlık : 0,76 kg / 1.676 lb Uzunluk : 200 mm / 7.87 inch Gövde Diş Çapı : M16X1,5 Aşık Diş Çapı : M12X1,5 Aşık Konik Çapı : Ø14,6	8J0423811

\* Bu sayfada ve katalogdaki tüm araçların adları, markaları, modelleri, sembolleri, logoları, orjinal numaraları (oe) ve diğer üçüncü parti numaraları sadece referans amaçlı kullanılmaktadır.













TT	8J3		2006 - 2014
Resim	Ürün Kodu ve Açıklaması	Detay	OEM
	<b>AU3010</b> ROTMİLİ SAĞ-SOL M16X1,5 L=226	Ağırlık : 0,608 kg / 1.340 lb Uzunluk : 226 mm / 8.90 inch Gövde Diş Çapı : M16X1,5 Aşık Diş Çapı : M16X1,5	4H0422810, 4H0422810A
	<b>SK4005</b> Z ROT ÖM SAĞ-SOL L=335MM	Ağırlık : 0,322 kg / 0.710 lb Malzeme Türü : Metal Uzunluk : 335 mm / 13.19 inch Aşık Diş Çapı : M12X1,5	5Q0411315B
	<b>VW4014</b> Z ROT ÖN SAĞ-SOL METAL 335 RB2935	Ağırlık : 0,46 kg / 1.014 lb Malzeme Türü : Metal Uzunluk : 335 mm / 13.19 inch Aşık Diş Çapı : M12X1,5	1K0411315B, 1K0411315D 1K0411315J, 1K0411315K 1K0411315R, 5Q0411315A 5Q0411315B
	<b>AU6010</b> SALINCAK ÜST SOL VE SAĞ RA5155	Ağırlık : 1,298 kg / 2.862 lb Malzeme Türü : Sac Metal	1K0505323H, 1K0505323N
	<b>AU6019</b> SALINCAK ALT SAĞ	Ağırlık : 3,976 kg / 8.766 lb Malzeme Türü : Alüminyum	8J0407152D
	<b>AU6019J</b> SALINCAK ALT	Ağırlık : 3,036 kg / 6.693 lb Malzeme Türü : Alüminyum	8J0407151D, 8J0407152D
	<b>AU6020</b> SALINCAK ALT SOL	Ağırlık : 3,976 kg / 8.766 lb Malzeme Türü : Alüminyum	8J0407151D
	<b>AU9006</b> SALINCAK ÖN TARAF SAĞ	Ağırlık : 1,79 kg / 3.946 lb Malzeme Türü : Sac Metal	1T0505224F
	<b>AU9007</b> SALINCAK ÖN TARAF SOL	Ağırlık : 1,79 kg / 3.946 lb Malzeme Türü : Sac Metal	1T0505223F
	<b>AU9037</b> SALINCAK ARKA ALT SAĞ SAC LEVHA	Ağırlık : 1,735 kg / 3.825 lb Malzeme Türü : Sac Metal	3C0505224E
	<b>AU9038</b> SALINCAK VE DENGE KOLU ARKA ALT SOL SAC LEVHA	Ağırlık : 1,735 kg / 3.825 lb Malzeme Türü : Sac Metal	3C0505223E

\* Bu sayfada ve katalogdaki tüm araçların adları, markaları, modelleri, sembolleri, logoları, orjinal numaraları (oe) ve diğer üçüncü parti numaraları sadece referans amaçlı kullanılmaktadır.

TT	8J3		2006 - 2014
Resim	Ürün Kodu ve Açıklaması	Detay	OEM
	<b>SK6011J</b> SALINCAK ÖN ALT SAĞ RD10232	Ağırlık : 3,691 kg / 8.137 lb Malzeme Türü : Sac Metal	1K0407152B, 1K0407152BC
	<b>SK6012J</b> SALINCAK ÖN ALT SOL RD10233	Ağırlık : 3,691 kg / 8.137 lb Malzeme Türü : Sac Metal	1K0407151BC, 1K0407151H
	<b>VW9002</b> SALINCAK ÖN TARAF SAĞ	Ağırlık : 1,79 kg / 3.946 lb Malzeme Türü : Sac Metal	1K0505224E, 1K0505224H 1K0505224K
	<b>VW9003</b> SALINCAK ÖN TARAF SOL	Ağırlık : 1,79 kg / 3.946 lb Malzeme Türü : Sac Metal	1K0505223E, 1K0505223H 1K0505223K
	<b>VW9004</b> SALINCAK ARKA	Ağırlık : 1,3 kg / 2.866 lb Malzeme Türü : Sac Metal	5Q0505323C, 5Q0505323D
	<b>AU11058</b> SALINCAK VE DENGE KOLU BURCU SOL VE SAĞ	Yön : Sol Ve Sağ Ağırlık : 0.81 kg / 1.786 lb	8J0199231
	<b>AU11088</b> SALINCAK VE DENGE KOLU BURCU ARKA	Şasi (Ön / Arka) : ARKA Ağırlık : 0,165 kg / 0.364 lb	1K0505541C, 1K0505541D 3C0505541
	<b>VW11037</b> SALINCAK VE DENGE KOLU BURCU SOL VE SAĞ	Yön : Sol Ve Sağ Ağırlık : 0.11 kg / 0.243 lb	1K0505279A
	<b>VW11042</b> SALINCAK VE DENGE KOLU BURCU ORTA SOL VE SAĞ	Yön : Orta Sol Ve Sağ Ağırlık : 0,182 kg / 0.401 lb	1K0407182, 5Q0407182
	<b>VW11043</b> SALINCAK VE DENGE KOLU BURCU SAĞ B22141	Yön : Sağ Diğer Taraf : VW11044 Ağırlık : 0,659 kg / 1.453 lb	1K0199232G, 1K0199232H 1K0199232J
	<b>VW11043B</b> SALINCAK VE DENGE KOLU BURCU SAĞ	Yön : Sağ Diğer Taraf : VW11044B Ağırlık : 0,659 kg / 1.453 lb Not : İÇ BURÇSUZ	1K0199232G, 1K0199232H 1K0199232J

\* Bu sayfada ve katalogdaki tüm araçların adları, markaları, modelleri, sembolleri, logoları, orjinal numaraları (oe) ve diğer üçüncü parti numaraları sadece referans amaçlı kullanılmaktadır.

TT	8J3		2006 - 2014
Resim	Ürün Kodu ve Açıklaması	Detay	OEM
	<b>VW11044</b> SALINCAK VE DENGE KOLU BURCU SOL B22142	Yön : Sol Diğer Taraf : VW11043 Ağırlık : 0,678 kg / 1.495 lb	1K0199231G, 1K0199231H 1K0199231J
	<b>VW11044B</b> SALINCAK VE DENGE KOLU BURCU SOL	Yön : Sol Diğer Taraf : VW11043B Ağırlık : 0,678 kg / 1.495 lb Not : İÇ BURÇSUZ	1K0199231G, 1K0199231H 1K0199231J
	<b>AU12029</b> ROTMİLİ BURCU VE LASTİĞİ ÖN	Şasi (Ön / Arka) : ÖN	171419804*, 171419804A* 175419804*
	<b>AU12029K</b> ROTMİLİ BURCU VE LASTİĞİ ÖN	Şasi (Ön / Arka) : ÖN	171419804*, 171419804A* 175419804*
	<b>VW12159</b> TAŞIYICI DESTEK BURÇLARI ARKA SOL VE SAĞ	Şasi (Ön / Arka) : ARKA Yön : Sol Ve Sağ Ağırlık : 0,130 kg / 0.287 lb	1K0505553, 1K0505553A
	<b>AU12024</b> TORSİYON BURCU ARKA SOL VE SAĞ	Şasi (Ön / Arka) : ARKA Yön : Sol Ve Sağ Ağırlık : 0,557 kg / 1.228 lb	1K0505145F, 1K0505145H 1K0505145K
	<b>VW12064</b> VİRAJ DEMİR LASTİĞİ SOL VE SAĞ RUBBER	Şasi (Ön / Arka) : ÖN Yön : Sol Ve Sağ Ağırlık : 0,023 kg / 0.051 lb Malzeme Türü : Rubber Not : D=Ø21mm	1J0411314C, 1J0411314R
	<b>VW12064K</b> VİRAJ DEMİR LASTİĞİ SOL VE SAĞ RUBBER	Şasi (Ön / Arka) : ÖN Yön : Sol Ve Sağ Ağırlık : 0,046 kg / 0.101 lb Malzeme Türü : Rubber	1J0411314C*
	<b>VW12137</b> VİRAJ DEMİR LASTİĞİ	Şasi (Ön / Arka) : ARKA Ağırlık : 0,070 kg / 0.154 lb Not : Ø17mm	1K0511327AQ
	<b>VW12137K</b> VİRAJ DEMİR LASTİĞİ	Şasi (Ön / Arka) : ARKA Ağırlık : 0,140 kg / 0.309 lb Not : KIT	1K0511327AQ
	<b>VW12017</b> AMORTİSÖR TAKOZU SOL VE SAĞ AMORTİSÖR TAKOZU	Yön : Sol Ve Sağ Ağırlık : 0,847 kg / 1.867 lb Not : AMORTİSÖR TAKOZU	1K0412331B, 1K0412331C

\* Bu sayfada ve katalogdaki tüm araçların adları, markaları, modelleri, sembolleri, logoları, orjinal numaraları (oe) ve diğer üçüncü parti numaraları sadece referans amaçlı kullanılmaktadır.









TT	8J3	2006 - 2014	
Resim	Ürün Kodu ve Açıklaması	Detay	OEM
	<b>VW12109</b> AMORTİSÖR TAKOZU SOL VE SAĞ AMORTİSÖR RULMANI	Yön : Sol Ve Sağ Ağırlık : 0.26 kg / 0.573 lb Not : AMORTİSÖR RULMANI	6N0412249C, 6N0412249E
	<b>VW12109K</b> AMORTİSÖR TAKOZU SOL VE SAĞ 2 PCS	Yön : Sol Ve Sağ Ağırlık : 0.52 kg / 1.146 lb Not : 2 PCS	6N0412249C, 6N0412249E
	<b>AU12021</b> MOTOR TAKOZU SOL VE SAĞ MOTOR TAKOZU	Yön : Sol Ve Sağ Ağırlık : 0.6 kg / 1.323 lb Malzeme Türü : Motor TakoZu	5N0199855B, 5N0199855C 5N0199855E
	<b>VW12097</b> MOTOR TAKOZU SOL VE SAĞ MOTOR TAKOZU	Yön : Sol Ve Sağ Ağırlık : 0.251 kg / 0.553 lb Not : MOTOR TAKOZU	1K0199868, 1K0199868A 1K0199868C, 1K0199868P 1K0199868Q
	<b>VW12105</b> MOTOR TAKOZU SOL VE SAĞ MOTOR TAKOZU ARKA	Yön : Sol Ve Sağ Ağırlık : 0.564 kg / 1.243 lb Not : MOTOR TAKOZU ARKA	3C0199855, 3C0199855H 3C0199855M
	<b>VW12110</b> MOTOR TAKOZU SOL VE SAĞ MOTOR TAKOZU	Yön : Sol Ve Sağ Ağırlık : 1.918 kg / 4.228 lb Not : MOTOR TAKOZU	1K0199262AB, 1K0199262AM 1K0199262M
	<b>AU12041</b> SÜSPANSİYON TAKOZU ARKA	Şasi (Ön / Arka) : ARKA Ağırlık : 0,075 kg / 0.165 lb	8J0511353F
	<b>VW12086</b> RADYATÖR TAKOZU SOL VE SAĞ RADYATÖR ÜST LASTİĞİ	Yön : Sol Ve Sağ Ağırlık : 0.024 kg / 0.053 lb Not : RADYATÖR ÜST LASTİĞİ	1K0121367F
	<b>VW13006</b> DİREKSİYON KÖRÜĞÜ	Ağırlık : 0.145 kg / 0.320 lb	1K0423831A, 5C0423831
	<b>VW13006K</b> DİREKSİYON KÖRÜĞÜ SOL VE SAĞ 2 PİECES	Ağırlık : 0.29 kg / 0.639 lb	1K0423831A, 5C0423831
	<b>VW14003</b> AKS KÖRÜĞÜ +KELEPÇE+YAĞ. DIŞ	Ağırlık : 0.25 kg / 0.551 lb	1K0 498 203, 1K0498203

\* Bu sayfada ve katalogdaki tüm araçların adları, markaları, modelleri, sembolleri, logoları, orjinal numaraları (oe) ve diğer üçüncü parti numaraları sadece referans amaçlı kullanılmaktadır.











**TT 8J3 2006 - 2014**

Resim	Ürün Kodu ve Açıklaması	Detay	OEM
	<b>VW14011</b> AKS KÖRÜĞÜ +KELEPÇE+YAĞ. İÇ	Ağırlık : 0.236 kg / 0.520 lb	1K0498201D
	<b>AU15001</b> AMORTİSÖR KÖRÜĞÜ ÖN	Şasi (Ön / Arka) : ÖN Ağırlık : 0,110 kg / 0.243 lb	6N0413175A

**TT 8N3 1999 - 2006**

Resim	Ürün Kodu ve Açıklaması	Detay	OEM
	<b>AU1013</b> ROTİL ÖN ALT SAĞ - SOL Ø15,5 RB2535	Ağırlık : 0,555 kg / 1.224 lb Konik Ölçüsü : Ø15,5 Bağlantı Delik Çapı : Ø10,7 Aşık Diş Çapı : M12X1,5	8N0.407.365A, 8N0.407.365B 8N0.407.365C, 8N0407365A 8N0407365B, 8N0407365C
	<b>AU2011</b> ROTBAŞI ÖN SAĞ RB2321	Ağırlık : 0,345 kg / 0.761 lb Uzunluk : 85 mm / 3.35 inch Gövde Diş Çapı : M16X1,5 Aşık Diş Çapı : M12X1,5 Aşık Konik Çapı : Ø13,3	8N0422812, 8N0422812A
	<b>AU2012</b> ROTBAŞI ÖN SOL RB2320	Ağırlık : 0,345 kg / 0.761 lb Uzunluk : 85 mm / 3.35 inch Gövde Diş Çapı : M16X1,5 Aşık Diş Çapı : M12X1,5 Aşık Konik Çapı : Ø13,3	8N0422811A
	<b>AU3008</b> ROTMİLİ SAĞ-SOL 331 RB2820	Ağırlık : 0,674 kg / 1.486 lb Uzunluk : 330 mm / 12.99 inch Gövde Diş Çapı : M16X1,5 Aşık Diş Çapı : M16X1,5	8N0422803A, 8N0422803C 8N0422804A, 8N0422804C 8N0422807A, 8N0422807C
	<b>AU3015</b> ROTMİLİ ÖN SAĞ - SOL	Ağırlık : 0.772 kg / 1.702 lb	PART OF 8N0422803D, PART OF 8N0422804D
	<b>AU20113008</b> ROT TAKIMI ÖN AKS SAĞ RB288119	Ağırlık : 1,023 kg / 2.255 lb Rotbaşı : AU2011 Rotmili : AU3008	8N0422804A, 8N0422804C
	<b>AU20113015</b> ROT TAKIMI ÖN SAĞ	Ağırlık : 1,045 kg / 2.304 lb Rotbaşı : AU2011 Rotmili : AU3015	8N0422804D
	<b>AU20123008</b> ROT TAKIMI SOL KOMPLE RB288118	Ağırlık : 1,023 kg / 2.255 lb Rotbaşı : AU2012 Rotmili : AU3008	8N0422803A, 8N0422803C

\* Bu sayfada ve katalogdaki tüm araçların adları, markaları, modelleri, sembolleri, logoları, orijinal numaraları (oe) ve diğer üçüncü parti numaraları sadece referans amaçlı kullanılmaktadır.

TT	8N3		1999 - 2006
Resim	Ürün Kodu ve Açıklaması	Detay	OEM
	<b>AU20123015</b> ROT TAKIMI ÖN SOL	Ağırlık : 1,045 kg / 2.304 lb Rotbaşı : AU2012 Rotmili : AU3015	8N0422803D
	<b>AU4005</b> Z ROT ÖN SOL METAL RB2924	Ağırlık : 0,602 kg / 1.327 lb Malzeme Türü : Metal Uzunluk : 335 mm / 13.19 inch Aşık Diş Çapı : M12X1,5	1J0411315D, 1J0411615D
	<b>AU4006</b> Z ROT ÖN SAĞ METAL RB2923	Ağırlık : 0,282 kg / 0.622 lb Malzeme Türü : Metal Uzunluk : 335 mm / 13.19 inch Aşık Diş Çapı : M12X1,5	1J0411316D
	<b>AU4021</b> Z ROT SOL VE SAĞ METAL RB2940	Ağırlık : 0,26 kg / 0.573 lb Malzeme Türü : Metal Uzunluk : 175 mm / 6.89 inch Aşık Diş Çapı : M10X1,5	1J0505466, 1J0505466B 1J0505466C
	<b>AU6010</b> SALINCAK ÜST SOL VE SAĞ RA5155	Ağırlık : 1,298 kg / 2.862 lb Malzeme Türü : Sac Metal	1K0505323H, 1K0505323N
	<b>AU6017</b> SALINCAK ÖN SAĞ	Ağırlık : 5,42 kg / 11.949 lb Malzeme Türü : Dövme Çelik	8N0407151A*
	<b>AU6017J</b> SALINCAK ÖN SAĞ	Ağırlık : 4,66 kg / 10.274 lb Malzeme Türü : Dövme Çelik	8N0407151A
	<b>AU6018</b> SALINCAK ÖN SOL	Ağırlık : 5,42 kg / 11.949 lb Malzeme Türü : Dövme Çelik	8N0407152A*
	<b>AU6018J</b> SALINCAK ÖN SOL	Ağırlık : 4,66 kg / 10.274 lb Malzeme Türü : Dövme Çelik	8N0407152A
	<b>SE9001</b> SALINCAK ALT SAĞ RA5150	Ağırlık : 1 kg / 2.205 lb Malzeme Türü : Sac Metal	1K0501530C
	<b>SE9002</b> SALINCAK ALT SOL RA5151	Ağırlık : 1 kg / 2.205 lb Malzeme Türü : Sac Metal	1K0501529F

\* Bu sayfada ve katalogdaki tüm araçların adları, markaları, modelleri, sembolleri, logoları, orjinal numaraları (oe) ve diğer üçüncü parti numaraları sadece referans amaçlı kullanılmaktadır.

TT	8N3		1999 - 2006
Resim	Ürün Kodu ve Açıklaması	Detay	OEM
	<b>SE9003</b> SALINCAK ALT VE ÜST SOL VE SAĞ	Ağırlık : 1,080 kg / 2.381 lb Malzeme Türü : Sac Metal	1J0505323H, 1J0505323J 1J0505323L, 1J0505323M 1J0505323N
	<b>AU11056</b> SALINCAK VE DENGE KOLU BURCU İÇ SOL VE SAĞ	Yön : İç Sol Ve Sağ Ağırlık : 0,14 kg / 0.309 lb	8N0407181B
	<b>AU11057</b> SALINCAK VE DENGE KOLU BURCU SOL VE SAĞ	Yön : Sol Ve Sağ Ağırlık : 0,12 kg / 0.265 lb	8N0407182A
	<b>AU11023</b> Z-ROT BURCU ARKA	Şasi (Ön / Arka) : ARKA Ağırlık : 0.26 kg / 0.573 lb Uzunluk : AU4021 mm / 0.00 inch Aşık Diş Çapı : VW4017	1J0505466B*
	<b>VW11008</b> TAŞIYIÇI DESTEK BURÇLARI SOL VE SAĞ	Yön : Sol Ve Sağ Ağırlık : 0.24 kg / 0.529 lb	1J0505203, 1J0505365D 1J0505365F, 1J0505365G 1J0505365J, 1J0505365K 1J0505365M, 1J0505365N
	<b>VW12010</b> TORSİYON BURCU SOL VE SAĞ	Yön : Sol Ve Sağ Ağırlık : 0.31 kg / 0.683 lb	1J0500045, 1J0500045A 1J0501541B, 1J0501541C 6R0501541A, 6R0501541B
	<b>VW12016</b> VİRAJ DEMİR LASTİĞİ SOL VE SAĞ RUBBER	Şasi (Ön / Arka) : ÖN Yön : Sol Ve Sağ Ağırlık : 0.03 kg / 0.066 lb Malzeme Türü : Rubber	1J0411314G, 1J0411314T 8N0411303G, 8N0411303H
	<b>VW12016K</b> VİRAJ DEMİR LASTİĞİ SOL VE SAĞ RUBBER	Şasi (Ön / Arka) : ÖN Yön : Sol Ve Sağ Ağırlık : 0.06 kg / 0.132 lb Malzeme Türü : Rubber Not : İKİLİ	1J0411314G, 1J0411314T 8N0411303G, 8N0411303H
	<b>VW12020</b> VİRAJ DEMİR LASTİĞİ SOL VE SAĞ RUBBER	Şasi (Ön / Arka) : ÖN Yön : Sol Ve Sağ Ağırlık : 0.07 kg / 0.154 lb Malzeme Türü : Rubber Not : VİRAJ ORTA LASTİĞİ	8D0511327C
	<b>VW12020K</b> VİRAJ DEMİR LASTİĞİ SOL VE SAĞ RUBBER	Şasi (Ön / Arka) : ÖN Yön : Sol Ve Sağ Ağırlık : 0.14 kg / 0.309 lb Malzeme Türü : Rubber	8D0511327C*
	<b>VW12047</b> VİRAJ DEMİR LASTİĞİ SOL VE SAĞ RUBBER	Şasi (Ön / Arka) : ÖN Yön : Sol Ve Sağ Ağırlık : 0.14 kg / 0.309 lb Malzeme Türü : Rubber Not : VİRAJ LASTİĞİ	1J0411314B, 1J0411314S

\* Bu sayfada ve katalogdaki tüm araçların adları, markaları, modelleri, sembolleri, logoları, orijinal numaraları (oe) ve diğer üçüncü parti numaraları sadece referans amaçlı kullanılmaktadır.

TT	8N3		1999 - 2006
Resim	Ürün Kodu ve Açıklaması	Detay	OEM
	<b>VW12047K</b> VİRAJ DEMİR LASTİĞİ SOL VE SAĞ RUBBER	Şasi (Ön / Arka) : ÖN Yön : Sol Ve Sağ Ağırlık : 0.28 kg / 0.617 lb Malzeme Türü : Rubber Not : VİRAJ LASTİĞİ ( 2 ADET)	1J0411314B*, 1J0411314B 1J0411314S*, 1J0411314S
	<b>VW12048</b> VİRAJ DEMİR LASTİĞİ SOL VE SAĞ RUBBER	Şasi (Ön / Arka) : ÖN Yön : Sol Ve Sağ Ağırlık : 0.03 kg / 0.066 lb Malzeme Türü : Rubber Not : VİRAJ LASTİĞİ	1J0411314P
	<b>VW12048K</b> VİRAJ DEMİR LASTİĞİ SOL VE SAĞ RUBBER	Şasi (Ön / Arka) : ÖN Yön : Sol Ve Sağ Ağırlık : 0.06 kg / 0.132 lb Malzeme Türü : Rubber	1J0411314P*
	<b>VW12052</b> VİRAJ DEMİR LASTİĞİ SOL VE SAĞ RUBBER	Şasi (Ön / Arka) : ÖN Yön : Sol Ve Sağ Ağırlık : 0.06 kg / 0.132 lb Malzeme Türü : Rubber Not : VİRAJ LASTİĞİ	1J0411314R
	<b>VW12052K</b> VİRAJ DEMİR LASTİĞİ SOL VE SAĞ RUBBER	Şasi (Ön / Arka) : ÖN Yön : Sol Ve Sağ Ağırlık : 0.12 kg / 0.265 lb Malzeme Türü : Rubber	1J0411314R*
	<b>VW12064</b> VİRAJ DEMİR LASTİĞİ SOL VE SAĞ RUBBER	Şasi (Ön / Arka) : ÖN Yön : Sol Ve Sağ Ağırlık : 0,023 kg / 0.051 lb Malzeme Türü : Rubber Not : D=Ø21mm	1J0411314C, 1J0411314R
	<b>VW12064K</b> VİRAJ DEMİR LASTİĞİ SOL VE SAĞ RUBBER	Şasi (Ön / Arka) : ÖN Yön : Sol Ve Sağ Ağırlık : 0.046 kg / 0.101 lb Malzeme Türü : Rubber	1J0411314C*
	<b>SK12002</b> AMORTİSÖR TAKOZU ARKA SOL VE SAĞ 1.2 / 1.4TSl / 1.6TDI / 1.2TDI	Şasi (Ön / Arka) : ARKA Yön : Sol Ve Sağ Ağırlık : 0,305 kg / 0.672 lb Not : 1.2 / 1.4TSl / 1.6TDI / 1.2TDI	1J0513353A, 1J0513353B 1J0513353C, 1J0513353G 6QE513353, 6R0513353 6R0513353B
	<b>VW12061</b> AMORTİSÖR TAKOZU SOL VE SAĞ AMORTİSÖR TAKOZU	Yön : Sol Ve Sağ Ağırlık : 0.27 kg / 0.595 lb Not : AMORTİSÖR TAKOZU	1H0412365A, 1J0412249 1J0412331BS, 1J0412331C
	<b>VW12061A</b> AMORTİSÖR TAKOZU SOL VE SAĞ AMORTİSOR RULMANI	Yön : Sol Ve Sağ Ağırlık : 0.08 kg / 0.176 lb Not : AMORTİSOR RULMANI	1J0412249, 1J0412249C 357412249, 357412249A 4503300051, 7201688 7201848, 95VW3K031AA
	<b>VW12061K</b> AMORTİSÖR TAKOZU SOL VE SAĞ 2 PCS	Yön : Sol Ve Sağ Ağırlık : 0.7 kg / 1.543 lb Not : 2 PCS	1H0412365A, 1J0412249 1J0412331BS, 1J0412331C





\* Bu sayfada ve katalogdaki tüm araçların adları, markaları, modelleri, sembolleri, logoları, orijinal numaraları (oe) ve diğer üçüncü parti numaraları sadece referans amaçlı kullanılmaktadır.













**TT 8N3 1999 - 2006**

Resim	Ürün Kodu ve Açıklaması	Detay	OEM
	<b>VW12103</b> AMORTİSÖR TAKOZU SOL VE SAĞ AMORTİSÖR ÜST TAKOZU	Yön : Sol Ve Sağ Ağırlık : 0.23 kg / 0.507 lb Not : AMORTİSÖR ÜST TAKOZU	1J0412331B, 1J0412331C
	<b>VW12085</b> MOTOR TAKOZU SOL VE SAĞ EGZOS TAKOZU	Yön : Sol Ve Sağ Ağırlık : 0.1 kg / 0.220 lb Not : EGZOS TAKOZU	1J0253144G, 1J0802117
	<b>VW12100</b> MOTOR TAKOZU SOL VE SAĞ MOTOR TAKOZU ARKA	Yön : Sol Ve Sağ Ağırlık : 1.12 kg / 2.469 lb Not : MOTOR TAKOZU ARKA	1J0199851AA, 1J0199851AK 1J0199851M, 1J0199851N
	<b>VW12096</b> SÜSPANSİYON TAKOZU SOL VE SAĞ SÜSPANSİYON TAKOZU	Yön : Sol Ve Sağ Ağırlık : 0.035 kg / 0.077 lb Not : SÜSPANSİYON TAKOZU	1J0412303
	<b>VW14003</b> AKS KÖRÜĞÜ +KELEPÇE+YAĞ. DIŞ	Ağırlık : 0.25 kg / 0.551 lb	1K0 498 203, 1K0498203
	<b>VW14011</b> AKS KÖRÜĞÜ +KELEPÇE+YAĞ. İÇ	Ağırlık : 0.236 kg / 0.520 lb	1K0498201D

**TT FV3 2015 -**

Resim	Ürün Kodu ve Açıklaması	Detay	OEM
	<b>AU1017</b> ROTİL SAĞ	Ağırlık : 0,612 kg / 1.349 lb	8J0407366
	<b>AU1017K</b> ROTİL SAĞ	Ağırlık : 0,712 kg / 1.570 lb	8J0407366
	<b>AU1018</b> ROTİL SOL	Ağırlık : 0,612 kg / 1.349 lb	8J0407365
	<b>AU1018K</b> ROTİL SOL	Ağırlık : 0,712 kg / 1.570 lb	8J0407365

\* Bu sayfada ve katalogdaki tüm araçların adları, markaları, modelleri, sembolleri, logoları, orjinal numaraları (oe) ve diğer üçüncü parti numaraları sadece referans amaçlı kullanılmaktadır.





TT	FV3		2015 -
Resim	Ürün Kodu ve Açıklaması	Detay	OEM
	<b>AU2025</b> ROTBAŞI SAĞ M16X1,5	Ağırlık : 0,702 kg / 1.548 lb Uzunluk : 203 mm / 7.99 inch Gövde Diş Çapı : M16X1,5 Aşık Diş Çapı : M14X1,5 Aşık Konik Çapı : Ø15,6	8S0423812A
	<b>AU2026</b> ROTBAŞI SOL M16X1,5	Ağırlık : 0,702 kg / 1.548 lb Uzunluk : 203 mm / 7.99 inch Gövde Diş Çapı : M16X1,5 Aşık Diş Çapı : M14X1,5 Aşık Konik Çapı : Ø15,6	8S0423811A
	<b>AU3016</b> ROTMİLİ 212.5	Ağırlık : 0,565 kg / 1.246 lb Uzunluk : 212.5 mm / 8.37 inch	8S0423810A
	<b>SK4005</b> Z ROT ÖM SAĞ-SOL L=335MM	Ağırlık : 0,322 kg / 0.710 lb Malzeme Türü : Metal Uzunluk : 335 mm / 13.19 inch Aşık Diş Çapı : M12X1,5	5Q0411315B
	<b>VW4014</b> Z ROT ÖN SAĞ-SOL METAL 335 RB2935	Ağırlık : 0,46 kg / 1.014 lb Malzeme Türü : Metal Uzunluk : 335 mm / 13.19 inch Aşık Diş Çapı : M12X1,5	1K0411315B, 1K0411315D 1K0411315J, 1K0411315K 1K0411315R, 5Q0411315A 5Q0411315B
	<b>VW4031</b> Z ROT ARKA PLASTİK	Ağırlık : 0,15 kg / 0.331 lb Malzeme Türü : Plastik Uzunluk : 70 mm / 2.76 inch Aşık Diş Çapı : M10X1,5	5Q0505465A, 5Q0505465C
	<b>AU6010</b> SALINCAK ÜST SOL VE SAĞ RA5155	Ağırlık : 1,298 kg / 2.862 lb Malzeme Türü : Sac Metal	1K0505323H, 1K0505323N
	<b>AU6019</b> SALINCAK ALT SAĞ	Ağırlık : 3,976 kg / 8.766 lb Malzeme Türü : Alüminyum	8J0407152D
	<b>AU6019J</b> SALINCAK ALT	Ağırlık : 3,036 kg / 6.693 lb Malzeme Türü : Alüminyum	8J0407151D, 8J0407152D
	<b>AU6020</b> SALINCAK ALT SOL	Ağırlık : 3,976 kg / 8.766 lb Malzeme Türü : Alüminyum	8J0407151D
	<b>AU9009</b> SALINCAK ALT SOL VE SAĞ	Ağırlık : 2,910 kg / 6.415 lb Malzeme Türü : Sac Metal	5Q0505311C, 5Q0505311D

\* Bu sayfada ve katalogdaki tüm araçların adları, markaları, modelleri, semboller, logoları, orjinal numaraları (oe) ve diğer üçüncü parti numaraları sadece referans amaçlı kullanılmaktadır.

TT	FV3		2015 -
Resim	Ürün Kodu ve Açıklaması	Detay	OEM
	<b>AU9012</b> SALINCAK ARKA ALT SAĞ	Ağırlık : 1,640 kg / 3.616 lb Malzeme Türü : Sac Metal	5Q0505224D
	<b>AU9013</b> SALINCAK ARKA ALT SOL	Ağırlık : 1,640 kg / 3.616 lb Malzeme Türü : Sac Metal	5Q0505223D
	<b>VW9005</b> SALINCAK ARKA ALT ÖNDEN	Ağırlık : 0,566 kg / 1.248 lb Malzeme Türü : Sac Metal	5Q0501529C, 5Q0501529D 5Q0501529E, 5Q0501529F
	<b>AU11058</b> SALINCAK VE DENGİ KOLU BURCU SOL VE SAĞ	Yön : Sol Ve Sağ Ağırlık : 0.81 kg / 1.786 lb	8J0199231
	<b>AU11068</b> SALINCAK VE DENGİ KOLU BURCU ARKA ALT SOL VE SAĞ METAL	Şasi (Ön / Arka) : ARKA Yön : Alt Sol Ve Sağ Ağırlık : 0,201 kg / 0.443 lb Malzeme Türü : Metal	PART OF 5Q0505223D, PART OF 5Q0505224D
	<b>AU11070</b> SALINCAK VE DENGİ KOLU BURCU ARKA ALT	Şasi (Ön / Arka) : ARKA Yön : Alt Ağırlık : 0,100 kg / 0.220 lb	5Q0505171, 5Q0505311C 5Q0505311CSK, 5Q0505311D 5Q0505311DSK
	<b>VW11042</b> SALINCAK VE DENGİ KOLU BURCU ORTA SOL VE SAĞ	Yön : Orta Sol Ve Sağ Ağırlık : 0,182 kg / 0.401 lb	1K0407182, 5Q0407182
	<b>VW11075</b> SALINCAK VE DENGİ KOLU BURCU ARKA SOL VE SAĞ	Şasi (Ön / Arka) : ARKA Yön : Sol Ve Sağ Ağırlık : 0,870 kg / 1.918 lb Not : FORWARD and INNER	Part of 5Q0501529C, Part of 5Q0501529D Part of 5Q0501529E, Part of 5Q0501529F
	<b>VW11076</b> SALINCAK VE DENGİ KOLU BURCU ARKA SOL VE SAĞ	Şasi (Ön / Arka) : ARKA Yön : Sol Ve Sağ Ağırlık : 0,870 kg / 1.918 lb Not : FORWARD and OUTER	Part of 5Q0501529C, Part of 5Q0501529D Part of 5Q0501529E, Part of 5Q0501529F
	<b>AU11080</b> BEŞİK (TRAVERS) BURCU ÖN ALT	Şasi (Ön / Arka) : ÖN Yön : Alt Ağırlık : 0,135 kg / 0.298 lb	5Q0505553
	<b>AU12019</b> MOTOR TAKOZU SOL VE SAĞ MOTOR TAKOZU	Yön : Sol Ve Sağ Ağırlık : 0.204 kg / 0.450 lb Malzeme Türü : Motor TakoZu	5Q0198037, 5QD199867

\* Bu sayfada ve katalogdaki tüm araçların adları, markaları, modelleri, sembolleri, logoları, orijinal numaraları (oe) ve diğer üçüncü parti numaraları sadece referans amaçlı kullanılmaktadır.

TT	FV3	2015 -	
Resim	Ürün Kodu ve Açıklaması	Detay	OEM
	<b>AU12019K</b> MOTOR TAKOZU SOL VE SAĞ MOTOR TAKOZU TAKIM	Yön : Sol Ve Sağ Ağırlık : 0.408 kg / 0.899 lb Malzeme Türü : Motor Takozu Takim	5Q0198037
	<b>AU12020</b> MOTOR TAKOZU SOL VE SAĞ MOTOR TAKOZU	Yön : Sol Ve Sağ Ağırlık : 0.21 kg / 0.463 lb Malzeme Türü : Motor Takozu	5Q0198037, 5Q0199868 5QD199868
	<b>AU12026</b> MOTOR TAKOZU ÖN SOL VE SAĞ	Şasi (Ön / Arka) : ÖN Yön : Sol Ve Sağ Ağırlık : 0,850 kg / 1.874 lb	5Q0199855AD, 5Q0199855J 5Q0199855P, 5Q0199855Q
	<b>VW12157</b> MOTOR TAKOZU ÖN SOL VE SAĞ	Şasi (Ön / Arka) : ÖN Yön : Sol Ve Sağ Ağırlık : 2.2 kg / 4.850 lb	5Q0199555AF, 5Q0199555T 5Q0199555AP
	<b>VW12086</b> RADYATÖR TAKOZU SOL VE SAĞ RADYATÖR ÜST LASTİĞİ	Yön : Sol Ve Sağ Ağırlık : 0.024 kg / 0.053 lb Not : RADYATÖR ÜST LASTİĞİ	1K0121367F

TT ROADSTER	8J9	2007 - 2014	
Resim	Ürün Kodu ve Açıklaması	Detay	OEM
	<b>AU1017</b> ROTİL SAĞ	Ağırlık : 0,612 kg / 1.349 lb	8J0407366
	<b>AU1017K</b> ROTİL SAĞ	Ağırlık : 0,712 kg / 1.570 lb	8J0407366
	<b>AU1018</b> ROTİL SOL	Ağırlık : 0,612 kg / 1.349 lb	8J0407365
	<b>AU1018K</b> ROTİL SOL	Ağırlık : 0,712 kg / 1.570 lb	8J0407365
	<b>AU2023</b> ROTBAŞI SAĞ M16X1,5	Ağırlık : 0,76 kg / 1.676 lb Uzunluk : 200 mm / 7.87 inch Gövde Diş Çapı : M16X1,5 Aşık Diş Çapı : M12X1,5 Aşık Konik Çapı : Ø14,6	8J0423812











\* Bu sayfada ve katalogdaki tüm araçların adları, markaları, modelleri, sembolleri, logoları, orjinal numaraları (oe) ve diğer üçüncü parti numaraları sadece referans amaçlı kullanılmaktadır.

**TT ROADSTER**
**8J9**
**2007 - 2014**

Resim	Ürün Kodu ve Açıklaması	Detay	OEM
	<b>AU2024</b> ROTBAŞI SOL M16X1,5	Ağırlık : 0,76 kg / 1.676 lb Uzunluk : 200 mm / 7.87 inch Gövde Diş Çapı : M16X1,5 Aşık Diş Çapı : M12X1,5 Aşık Konik Çapı : Ø14,6	8J0423811
	<b>AU3010</b> ROTMİLİ SAĞ-SOL M16X1,5 L=226	Ağırlık : 0,608 kg / 1.340 lb Uzunluk : 226 mm / 8.90 inch Gövde Diş Çapı : M16X1,5 Aşık Diş Çapı : M16X1,5	4H0422810, 4H0422810A
	<b>SK4005</b> Z ROT ÖM SAĞ-SOL L=335MM	Ağırlık : 0,322 kg / 0.710 lb Malzeme Türü : Metal Uzunluk : 335 mm / 13.19 inch Aşık Diş Çapı : M12X1,5	5Q0411315B
	<b>VW4014</b> Z ROT ÖN SAĞ-SOL METAL 335 RB2935	Ağırlık : 0,46 kg / 1.014 lb Malzeme Türü : Metal Uzunluk : 335 mm / 13.19 inch Aşık Diş Çapı : M12X1,5	1K0411315B, 1K0411315D 1K0411315J, 1K0411315K 1K0411315R, 5Q0411315A 5Q0411315B
	<b>AU6019</b> SALINCAK ALT SAĞ	Ağırlık : 3,976 kg / 8.766 lb Malzeme Türü : Alüminyum	8J0407152D
	<b>AU6019J</b> SALINCAK ALT	Ağırlık : 3,036 kg / 6.693 lb Malzeme Türü : Alüminyum	8J0407151D, 8J0407152D
	<b>AU6020</b> SALINCAK ALT SOL	Ağırlık : 3,976 kg / 8.766 lb Malzeme Türü : Alüminyum	8J0407151D
	<b>AU9006</b> SALINCAK ÖN TARAF SAĞ	Ağırlık : 1,79 kg / 3.946 lb Malzeme Türü : Sac Metal	1T0505224F
	<b>AU9007</b> SALINCAK ÖN TARAF SOL	Ağırlık : 1,79 kg / 3.946 lb Malzeme Türü : Sac Metal	1T0505223F
	<b>AU9037</b> SALINCAK ARKA ALT SAĞ SAC LEVHA	Ağırlık : 1,735 kg / 3.825 lb Malzeme Türü : Sac Metal	3C0505224E
	<b>AU9038</b> SALINCAK VE DENGE KOLU ARKA ALT SOL SAC LEVHA	Ağırlık : 1,735 kg / 3.825 lb Malzeme Türü : Sac Metal	3C0505223E

\* Bu sayfada ve katalogdaki tüm araçların adları, markaları, modelleri, sembolleri, logoları, orjinal numaraları (oe) ve diğer üçüncü parti numaraları sadece referans amaçlı kullanılmaktadır.

**TT ROADSTER**
**8J9**
**2007 - 2014**

Resim	Ürün Kodu ve Açıklaması	Detay	OEM
	<b>AU11058</b> SALINCAK VE DENGE KOLU BURCU SOL VE SAĞ	Yön : Sol Ve Sağ Ağırlık : 0.81 kg / 1.786 lb	8J0199231
	<b>AU11088</b> SALINCAK VE DENGE KOLU BURCU ARKA	Şasi (Ön / Arka) : ARKA Ağırlık : 0,165 kg / 0.364 lb	1K0505541C, 1K0505541D 3C0505541
	<b>SK11009</b> SALINCAK VE DENGE KOLU BURCU ARKA SOL VE SAĞ	Şasi (Ön / Arka) : ARKA Yön : Sol Ve Sağ Ağırlık : 0,176 kg / 0.388 lb	1K0501529J*
	<b>SK11010</b> SALINCAK VE DENGE KOLU BURCU ARKA SOL VE SAĞ	Şasi (Ön / Arka) : ARKA Yön : Sol Ve Sağ Ağırlık : 0,196 kg / 0.432 lb Not : BÜYÜK	1K0501529J*
	<b>VW11037</b> SALINCAK VE DENGE KOLU BURCU SOL VE SAĞ	Yön : Sol Ve Sağ Ağırlık : 0.11 kg / 0.243 lb	1K0505279A
	<b>VW11042</b> SALINCAK VE DENGE KOLU BURCU ORTA SOL VE SAĞ	Yön : Orta Sol Ve Sağ Ağırlık : 0,182 kg / 0.401 lb	1K0407182, 5Q0407182
	<b>AU12029</b> ROTMİLİ BURCU VE LASTİĞİ ÖN	Şasi (Ön / Arka) : ÖN	171419804*, 171419804A* 175419804*
	<b>AU12029K</b> ROTMİLİ BURCU VE LASTİĞİ ÖN	Şasi (Ön / Arka) : ÖN	171419804*, 171419804A* 175419804*
	<b>VW12159</b> TAŞIYICI DESTEK BURÇLARI ARKA SOL VE SAĞ	Şasi (Ön / Arka) : ARKA Yön : Sol Ve Sağ Ağırlık : 0,130 kg / 0.287 lb	1K0505553, 1K0505553A
	<b>AU12024</b> TORSİYON BURCU ARKA SOL VE SAĞ	Şasi (Ön / Arka) : ARKA Yön : Sol Ve Sağ Ağırlık : 0.557 kg / 1.228 lb	1K0505145F, 1K0505145H 1K0505145K
	<b>VW12137</b> VİRAJ DEMİR LASTİĞİ	Şasi (Ön / Arka) : ARKA Ağırlık : 0,070 kg / 0.154 lb Not : Ø17mm	1K0511327AQ

\* Bu sayfada ve katalogdaki tüm araçların adları, markaları, modelleri, sembolleri, logoları, orjinal numaraları (oe) ve diğer üçüncü parti numaraları sadece referans amaçlı kullanılmaktadır.

**TT ROADSTER**
**8J9**
**2007 - 2014**

Resim	Ürün Kodu ve Açıklaması	Detay	OEM
	<b>VW12137K</b> VİRAJ DEMİR LASTİĞİ	Şasi (Ön / Arka) : ARKA Ağırlık : 0,140 kg / 0.309 lb Not : KIT	1K0511327AQ
	<b>VW12109</b> AMORTİSÖR TAKOZU SOL VE SAĞ AMORTİSÖR RULMANI	Yön : Sol Ve Sağ Ağırlık : 0.26 kg / 0.573 lb Not : AMORTİSÖR RULMANI	6N0412249C, 6N0412249E
	<b>VW12109K</b> AMORTİSÖR TAKOZU SOL VE SAĞ 2 PCS	Yön : Sol Ve Sağ Ağırlık : 0.52 kg / 1.146 lb Not : 2 PCS	6N0412249C, 6N0412249E
	<b>AU12021</b> MOTOR TAKOZU SOL VE SAĞ MOTOR TAKOZU	Yön : Sol Ve Sağ Ağırlık : 0.6 kg / 1.323 lb Malzeme Türü : Motor Takozu	5N0199855B, 5N0199855C 5N0199855E
	<b>VW12097</b> MOTOR TAKOZU SOL VE SAĞ MOTOR TAKOZU	Yön : Sol Ve Sağ Ağırlık : 0.251 kg / 0.553 lb Not : MOTOR TAKOZU	1K0199868, 1K0199868A 1K0199868C, 1K0199868P 1K0199868Q
	<b>VW12105</b> MOTOR TAKOZU SOL VE SAĞ MOTOR TAKOZU ARKA	Yön : Sol Ve Sağ Ağırlık : 0.564 kg / 1.243 lb Not : MOTOR TAKOZU ARKA	3C0199855, 3C0199855H 3C0199855M
	<b>AU12041</b> SÜSPANSİYON TAKOZU ARKA	Şasi (Ön / Arka) : ARKA Ağırlık : 0,075 kg / 0.165 lb	8J0511353F
	<b>VW12086</b> RADYATÖR TAKOZU SOL VE SAĞ RADYATÖR ÜST LASTİĞİ	Yön : Sol Ve Sağ Ağırlık : 0.024 kg / 0.053 lb Not : RADYATÖR ÜST LASTİĞİ	1K0121367F
	<b>VW13006</b> DİREKSİYON KÖRÜĞÜ	Ağırlık : 0.145 kg / 0.320 lb	1K0423831A, 5C0423831
	<b>VW13006K</b> DİREKSİYON KÖRÜĞÜ SOL VE SAĞ 2 PİECES	Ağırlık : 0.29 kg / 0.639 lb	1K0423831A, 5C0423831
	<b>VW14003</b> AKS KÖRÜĞÜ +KELEPÇE+YAĞ. DIŞ	Ağırlık : 0.25 kg / 0.551 lb	1K0 498 203, 1K0498203

\* Bu sayfada ve katalogdaki tüm araçların adları, markaları, modelleri, sembolleri, logoları, orjinal numaraları (oe) ve diğer üçüncü parti numaraları sadece referans amaçlı kullanılmaktadır.

**TT ROADSTER**
**8J9**
**2007 - 2014**

Resim	Ürün Kodu ve Açıklaması	Detay	OEM
	<b>AU15001</b> AMORTİSÖR KÖRÜĞÜ ÖN	Şasi (Ön / Arka) : ÖN Ağırlık : 0,110 kg / 0.243 lb	6N0413175A







**TT ROADSTER**
**8N9**
**1999 - 2006**

Resim	Ürün Kodu ve Açıklaması	Detay	OEM
	<b>AU1013</b> ROTİL ÖN ALT SAĞ - SOL Ø15,5 RB2535	Ağırlık : 0,555 kg / 1.224 lb Konik Ölçüsü : Ø15,5 Bağlantı Delik Çapı : Ø10,7 Aşık Diş Çapı : M12X1,5	8N0.407.365A, 8N0.407.365B 8N0.407.365C, 8N0407365A 8N0407365B, 8N0407365C
	<b>AU2011</b> ROTBAŞI ÖN SAĞ RB2321	Ağırlık : 0,345 kg / 0.761 lb Uzunluk : 85 mm / 3.35 inch Gövde Diş Çapı : M16X1,5 Aşık Diş Çapı : M12X1,5 Aşık Konik Çapı : Ø13,3	8N0422812, 8N0422812A
	<b>AU2012</b> ROTBAŞI ÖN SOL RB2320	Ağırlık : 0,345 kg / 0.761 lb Uzunluk : 85 mm / 3.35 inch Gövde Diş Çapı : M16X1,5 Aşık Diş Çapı : M12X1,5 Aşık Konik Çapı : Ø13,3	8N0422811A
	<b>AU3008</b> ROTMİLİ SAĞ-SOL 331 RB2820	Ağırlık : 0,674 kg / 1.486 lb Uzunluk : 330 mm / 12.99 inch Gövde Diş Çapı : M16X1,5 Aşık Diş Çapı : M16X1,5	8N0422803A, 8N0422803C 8N0422804A, 8N0422804C 8N0422807A, 8N0422807C
	<b>AU3015</b> ROTMİLİ ÖN SAĞ - SOL	Ağırlık : 0.772 kg / 1.702 lb	PART OF 8N0422803D, PART OF 8N0422804D
	<b>AU20113008</b> ROT TAKIMI ÖN AKS SAĞ RB288119	Ağırlık : 1,023 kg / 2.255 lb Rotbaşı : AU2011 Rotmili : AU3008	8N0422804A, 8N0422804C
	<b>AU20113015</b> ROT TAKIMI ÖN SAĞ	Ağırlık : 1,045 kg / 2.304 lb Rotbaşı : AU2011 Rotmili : AU3015	8N0422804D
	<b>AU20123008</b> ROT TAKIMI SOL KOMPLE RB288118	Ağırlık : 1,023 kg / 2.255 lb Rotbaşı : AU2012 Rotmili : AU3008	8N0422803A, 8N0422803C
	<b>AU20123015</b> ROT TAKIMI ÖN SOL	Ağırlık : 1,045 kg / 2.304 lb Rotbaşı : AU2012 Rotmili : AU3015	8N0422803D

\* Bu sayfada ve katalogdaki tüm araçların adları, markaları, modelleri, sembolleri, logoları, orijinal numaraları (oe) ve diğer üçüncü parti numaraları sadece referans amaçlı kullanılmaktadır.



**TT ROADSTER**
**8N9**
**1999 - 2006**

Resim	Ürün Kodu ve Açıklaması	Detay	OEM
	<b>AU4005</b> Z ROT ÖN SOL METAL RB2924	Ağırlık : 0,602 kg / 1.327 lb Malzeme Türü : Metal Uzunluk : 335 mm / 13.19 inch Aşık Diş Çapı : M12X1,5	1J0411315D, 1J0411615D
	<b>AU4006</b> Z ROT ÖN SAĞ METAL RB2923	Ağırlık : 0,282 kg / 0.622 lb Malzeme Türü : Metal Uzunluk : 335 mm / 13.19 inch Aşık Diş Çapı : M12X1,5	1J0411316D
	<b>AU4021</b> Z ROT SOL VE SAĞ METAL RB2940	Ağırlık : 0,26 kg / 0.573 lb Malzeme Türü : Metal Uzunluk : 175 mm / 6.89 inch Aşık Diş Çapı : M10X1,5	1J0505466, 1J0505466B 1J0505466C
	<b>AU6010</b> SALINCAK ÜST SOL VE SAĞ RA5155	Ağırlık : 1,298 kg / 2.862 lb Malzeme Türü : Sac Metal	1K0505323H, 1K0505323N
	<b>AU6017</b> SALINCAK ÖN SAĞ	Ağırlık : 5,42 kg / 11.949 lb Malzeme Türü : Dövme Çelik	8N0407151A*
	<b>AU6017J</b> SALINCAK ÖN SAĞ	Ağırlık : 4,66 kg / 10.274 lb Malzeme Türü : Dövme Çelik	8N0407151A
	<b>AU6018</b> SALINCAK ÖN SOL	Ağırlık : 5,42 kg / 11.949 lb Malzeme Türü : Dövme Çelik	8N0407152A*
	<b>AU6018J</b> SALINCAK ÖN SOL	Ağırlık : 4,66 kg / 10.274 lb Malzeme Türü : Dövme Çelik	8N0407152A
	<b>SE9001</b> SALINCAK ALT SAĞ RA5150	Ağırlık : 1 kg / 2.205 lb Malzeme Türü : Sac Metal	1K0501530C
	<b>SE9002</b> SALINCAK ALT SOL RA5151	Ağırlık : 1 kg / 2.205 lb Malzeme Türü : Sac Metal	1K0501529F
	<b>AU11056</b> SALINCAK VE DENGE KOLU BURCU İÇ SOL VE SAĞ	Yön : İç Sol Ve Sağ Ağırlık : 0,14 kg / 0.309 lb	8N0407181B

\* Bu sayfada ve katalogdaki tüm araçların adları, markaları, modelleri, sembolleri, logoları, orjinal numaraları (oe) ve diğer üçüncü parti numaraları sadece referans amaçlı kullanılmaktadır.

**TT ROADSTER**
**8N9**
**1999 - 2006**

Resim	Ürün Kodu ve Açıklaması	Detay	OEM
	<b>AU11057</b> SALINCAK VE DENGE KOLU BURCU SOL VE SAĐ	Yön : Sol Ve SaĐ Ağırlık : 0,12 kg / 0.265 lb	8N0407182A
	<b>AU11023</b> Z-ROT BURCU ARKA	Şasi (Ön / Arka) : ARKA Ağırlık : 0.26 kg / 0.573 lb Uzunluk : AU4021 mm / 0.00 inch Aşık Diş Çapı : VW4017	1J0505466B*
	<b>VW11008</b> TAŞIYICI DESTEK BURÇLARI SOL VE SAĐ	Yön : Sol Ve SaĐ Ağırlık : 0.24 kg / 0.529 lb	1J0505203, 1J0505365D 1J0505365F, 1J0505365G 1J0505365J, 1J0505365K 1J0505365M, 1J0505365N
	<b>VW12010</b> TORSİYON BURCU SOL VE SAĐ	Yön : Sol Ve SaĐ Ağırlık : 0.31 kg / 0.683 lb	1J0500045, 1J0500045A 1J0501541B, 1J0501541C 6R0501541A, 6R0501541B
	<b>VW12066</b> TORSİYON BURCU SOL VE SAĐ	Yön : Sol Ve SaĐ Ağırlık : 0.6 kg / 1.323 lb	1J0 501 541 D, 1J0501541D
	<b>VW12020</b> VİRAJ DEMİR LASTİĐİ SOL VE SAĐ RUBBER	Şasi (Ön / Arka) : ÖN Yön : Sol Ve SaĐ Ağırlık : 0.07 kg / 0.154 lb Malzeme Türü : Rubber Not : VİRAJ ORTA LASTİĐİ	8D0511327C
	<b>VW12020K</b> VİRAJ DEMİR LASTİĐİ SOL VE SAĐ RUBBER	Şasi (Ön / Arka) : ÖN Yön : Sol Ve SaĐ Ağırlık : 0.14 kg / 0.309 lb Malzeme Türü : Rubber	8D0511327C*
	<b>VW12047</b> VİRAJ DEMİR LASTİĐİ SOL VE SAĐ RUBBER	Şasi (Ön / Arka) : ÖN Yön : Sol Ve SaĐ Ağırlık : 0.14 kg / 0.309 lb Malzeme Türü : Rubber Not : VİRAJ LASTİĐİ	1J0411314B, 1J0411314S
	<b>VW12047K</b> VİRAJ DEMİR LASTİĐİ SOL VE SAĐ RUBBER	Şasi (Ön / Arka) : ÖN Yön : Sol Ve SaĐ Ağırlık : 0.28 kg / 0.617 lb Malzeme Türü : Rubber Not : VİRAJ LASTİĐİ ( 2 ADET)	1J0411314B*, 1J0411314B 1J0411314S*, 1J0411314S
	<b>VW12048</b> VİRAJ DEMİR LASTİĐİ SOL VE SAĐ RUBBER	Şasi (Ön / Arka) : ÖN Yön : Sol Ve SaĐ Ağırlık : 0.03 kg / 0.066 lb Malzeme Türü : Rubber Not : VİRAJ LASTİĐİ	1J0411314P
	<b>VW12048K</b> VİRAJ DEMİR LASTİĐİ SOL VE SAĐ RUBBER	Şasi (Ön / Arka) : ÖN Yön : Sol Ve SaĐ Ağırlık : 0.06 kg / 0.132 lb Malzeme Türü : Rubber	1J0411314P*

\* Bu sayfada ve katalogdaki tüm araçların adları, markaları, modelleri, sembolleri, logoları, orjinal numaraları (oe) ve diĐer üçüncü parti numaraları sadece referans amaçlı kullanılmaktadır.

**TT ROADSTER**
**8N9**
**1999 - 2006**



Resim	Ürün Kodu ve Açıklaması	Detay	OEM
	<b>VW12052</b> VİRAJ DEMİR LASTİĞİ SOL VE SAĞ RUBBER	Şasi (Ön / Arka) : ÖN Yön : Sol Ve Sağ Ağırlık : 0.06 kg / 0.132 lb Malzeme Türü : Rubber Not : VİRAJ LASTİĞİ	1J0411314R
	<b>VW12052K</b> VİRAJ DEMİR LASTİĞİ SOL VE SAĞ RUBBER	Şasi (Ön / Arka) : ÖN Yön : Sol Ve Sağ Ağırlık : 0.12 kg / 0.265 lb Malzeme Türü : Rubber	1J0411314R*
	<b>VW12064</b> VİRAJ DEMİR LASTİĞİ SOL VE SAĞ RUBBER	Şasi (Ön / Arka) : ÖN Yön : Sol Ve Sağ Ağırlık : 0,023 kg / 0.051 lb Malzeme Türü : Rubber Not : D=Ø21mm	1J0411314C, 1J0411314R
	<b>VW12064K</b> VİRAJ DEMİR LASTİĞİ SOL VE SAĞ RUBBER	Şasi (Ön / Arka) : ÖN Yön : Sol Ve Sağ Ağırlık : 0.046 kg / 0.101 lb Malzeme Türü : Rubber	1J0411314C*
	<b>SK12002</b> AMORTİSÖR TAKOZU ARKA SOL VE SAĞ 1.2 / 1.4TSI / 1.6TDI / 1.2TDI	Şasi (Ön / Arka) : ARKA Yön : Sol Ve Sağ Ağırlık : 0,305 kg / 0.672 lb Not : 1.2 / 1.4TSI / 1.6TDI / 1.2TDI	1J0513353A, 1J0513353B 1J0513353C, 1J0513353G 6QE513353, 6R0513353 6R0513353B
	<b>VW12061</b> AMORTİSÖR TAKOZU SOL VE SAĞ AMORTİSÖR TAKOZU	Yön : Sol Ve Sağ Ağırlık : 0.27 kg / 0.595 lb Not : AMORTİSÖR TAKOZU	1H0412365A, 1J0412249 1J0412331BS, 1J0412331C
	<b>VW12061A</b> AMORTİSÖR TAKOZU SOL VE SAĞ AMORTİSÖR RULMANI	Yön : Sol Ve Sağ Ağırlık : 0.08 kg / 0.176 lb Not : AMORTİSÖR RULMANI	1J0412249, 1J0412249C 357412249, 357412249A 4503300051, 7201688 7201848, 95VW3K031AA
	<b>VW12061K</b> AMORTİSÖR TAKOZU SOL VE SAĞ 2 PCS	Yön : Sol Ve Sağ Ağırlık : 0.7 kg / 1.543 lb Not : 2 PCS	1H0412365A, 1J0412249 1J0412331BS, 1J0412331C
	<b>VW12103</b> AMORTİSÖR TAKOZU SOL VE SAĞ AMORTİSÖR ÜST TAKOZU	Yön : Sol Ve Sağ Ağırlık : 0.23 kg / 0.507 lb Not : AMORTİSÖR ÜST TAKOZU	1J0412331B, 1J0412331C
	<b>VW12085</b> MOTOR TAKOZU SOL VE SAĞ EGZOS TAKOZU	Yön : Sol Ve Sağ Ağırlık : 0.1 kg / 0.220 lb Not : EGZOS TAKOZU	1J0253144G, 1J0802117
	<b>VW12100</b> MOTOR TAKOZU SOL VE SAĞ MOTOR TAKOZU ARKA	Yön : Sol Ve Sağ Ağırlık : 1.12 kg / 2.469 lb Not : MOTOR TAKOZU ARKA	1J0199851AA, 1J0199851AK 1J0199851M, 1J0199851N

\* Bu sayfada ve katalogdaki tüm araçların adları, markaları, modelleri, sembolleri, logoları, orjinal numaraları (oe) ve diğer üçüncü parti numaraları sadece referans amaçlı kullanılmaktadır.

**TT ROADSTER**
**8N9**
**1999 - 2006**











Resim	Ürün Kodu ve Açıklaması	Detay	OEM
	<b>VW12096</b> SÜSPANSİYON TAKOZU SOL VE SAĞ SÜSPANSİYON TAKOZU	Yön : Sol Ve Sağ Ağırlık : 0.035 kg / 0.077 lb Not : SÜSPANSİYON TAKOZU	1J0412303
	<b>VW14011</b> AKS KÖRÜĞÜ +KELEPÇE+YAĞ. İÇ	Ağırlık : 0.236 kg / 0.520 lb	1K0498201D

**TT ROADSTER**
**FV9**
**2015 -**

Resim	Ürün Kodu ve Açıklaması	Detay	OEM
	<b>AU1017</b> ROTİL SAĞ	Ağırlık : 0,612 kg / 1.349 lb	8J0407366
	<b>AU1017K</b> ROTİL SAĞ	Ağırlık : 0,712 kg / 1.570 lb	8J0407366
	<b>AU1018</b> ROTİL SOL	Ağırlık : 0,612 kg / 1.349 lb	8J0407365
	<b>AU1018K</b> ROTİL SOL	Ağırlık : 0,712 kg / 1.570 lb	8J0407365
	<b>AU2025</b> ROTBAŞI SAĞ M16X1,5	Ağırlık : 0,702 kg / 1.548 lb Uzunluk : 203 mm / 7.99 inch Gövde Diş Çapı : M16X1,5 Aşık Diş Çapı : M14X1,5 Aşık Konik Çapı : Ø15,6	8S0423812A
	<b>AU2026</b> ROTBAŞI SOL M16X1,5	Ağırlık : 0,702 kg / 1.548 lb Uzunluk : 203 mm / 7.99 inch Gövde Diş Çapı : M16X1,5 Aşık Diş Çapı : M14X1,5 Aşık Konik Çapı : Ø15,6	8S0423811A
	<b>AU3016</b> ROTMİLİ 212.5	Ağırlık : 0,565 kg / 1.246 lb Uzunluk : 212.5 mm / 8.37 inch	8S0423810A
	<b>SK4005</b> Z ROT ÖM SAĞ-SOL L=335MM	Ağırlık : 0,322 kg / 0.710 lb Malzeme Türü : Metal Uzunluk : 335 mm / 13.19 inch Aşık Diş Çapı : M12X1,5	5Q0411315B

\* Bu sayfada ve katalogdaki tüm araçların adları, markaları, modelleri, sembolleri, logoları, orijinal numaraları (oe) ve diğer üçüncü parti numaraları sadece referans amaçlı kullanılmaktadır.

**TT ROADSTER**
**FV9**
**2015 -**

Resim	Ürün Kodu ve Açıklaması	Detay	OEM
	<b>VW4014</b> Z ROT ÖN SAĞ-SOL METAL 335 RB2935	Ağırlık : 0,46 kg / 1.014 lb Malzeme Türü : Metal Uzunluk : 335 mm / 13.19 inch Aşık Diş Çapı : M12X1,5	1K0411315B, 1K0411315D 1K0411315J, 1K0411315K 1K0411315R, 5Q0411315A 5Q0411315B
	<b>AU6010</b> SALINCAK ÜST SOL VE SAĞ RA5155	Ağırlık : 1,298 kg / 2.862 lb Malzeme Türü : Sac Metal	1K0505323H, 1K0505323N
	<b>AU6019</b> SALINCAK ALT SAĞ	Ağırlık : 3,976 kg / 8.766 lb Malzeme Türü : Alüminyum	8J0407152D
	<b>AU6019J</b> SALINCAK ALT	Ağırlık : 3,036 kg / 6.693 lb Malzeme Türü : Alüminyum	8J0407151D, 8J0407152D
	<b>AU6020</b> SALINCAK ALT SOL	Ağırlık : 3,976 kg / 8.766 lb Malzeme Türü : Alüminyum	8J0407151D
	<b>AU9009</b> SALINCAK ALT SOL VE SAĞ	Ağırlık : 2,910 kg / 6.415 lb Malzeme Türü : Sac Metal	5Q0505311C, 5Q0505311D
	<b>AU9012</b> SALINCAK ARKA ALT SAĞ	Ağırlık : 1,640 kg / 3.616 lb Malzeme Türü : Sac Metal	5Q0505224D
	<b>AU9013</b> SALINCAK ARKA ALT SOL	Ağırlık : 1,640 kg / 3.616 lb Malzeme Türü : Sac Metal	5Q0505223D
	<b>VW9005</b> SALINCAK ARKA ALT ÖNDEN	Ağırlık : 0,566 kg / 1.248 lb Malzeme Türü : Sac Metal	5Q0501529C, 5Q0501529D 5Q0501529E, 5Q0501529F
	<b>AU11058</b> SALINCAK VE DENGE KOLU BURCU SOL VE SAĞ	Yön : Sol Ve Sağ Ağırlık : 0.81 kg / 1.786 lb	8J0199231
	<b>AU11068</b> SALINCAK VE DENGE KOLU BURCU ARKA ALT SOL VE SAĞ METAL	Şasi (Ön / Arka) : ARKA Yön : Alt Sol Ve Sağ Ağırlık : 0,201 kg / 0.443 lb Malzeme Türü : Metal	PART OF 5Q0505223D, PART OF 5Q0505224D

\* Bu sayfada ve katalogdaki tüm araçların adları, markaları, modelleri, sembolleri, logoları, orjinal numaraları (oe) ve diğer üçüncü parti numaraları sadece referans amaçlı kullanılmaktadır.

**TT ROADSTER**
**FV9**
**2015 -**

Resim	Ürün Kodu ve Açıklaması	Detay	OEM
	<b>AU11070</b> SALINCAK VE DENGE KOLU BURCU ARKA ALT	Şasi (Ön / Arka) : ARKA Yön : Alt Ağırlık : 0,100 kg / 0.220 lb	5Q0505171, 5Q0505311C 5Q0505311CSK, 5Q0505311D 5Q0505311DSK
	<b>VW11042</b> SALINCAK VE DENGE KOLU BURCU ORTA SOL VE SAĞ	Yön : Orta Sol Ve Sağ Ağırlık : 0,182 kg / 0.401 lb	1K0407182, 5Q0407182
	<b>VW11075</b> SALINCAK VE DENGE KOLU BURCU ARKA SOL VE SAĞ	Şasi (Ön / Arka) : ARKA Yön : Sol Ve Sağ Ağırlık : 0,870 kg / 1.918 lb Not : FORWARD and INNER	Part of 5Q0501529C, Part of 5Q0501529D Part of 5Q0501529E, Part of 5Q0501529F
	<b>VW11076</b> SALINCAK VE DENGE KOLU BURCU ARKA SOL VE SAĞ	Şasi (Ön / Arka) : ARKA Yön : Sol Ve Sağ Ağırlık : 0,870 kg / 1.918 lb Not : FORWARD and OUTER	Part of 5Q0501529C, Part of 5Q0501529D Part of 5Q0501529E, Part of 5Q0501529F
	<b>AU11080</b> BEŞİK (TRAVERS) BURCU ÖN ALT	Şasi (Ön / Arka) : ÖN Yön : Alt Ağırlık : 0,135 kg / 0.298 lb	5Q0505553
	<b>AU12019</b> MOTOR TAKOZU SOL VE SAĞ MOTOR TAKOZU	Yön : Sol Ve Sağ Ağırlık : 0.204 kg / 0.450 lb Malzeme Türü : Motor Takozu	5Q0198037, 5QD199867
	<b>AU12019K</b> MOTOR TAKOZU SOL VE SAĞ MOTOR TAKOZU TAKIM	Yön : Sol Ve Sağ Ağırlık : 0.408 kg / 0.899 lb Malzeme Türü : Motor Takozu Takim	5Q0198037
	<b>AU12020</b> MOTOR TAKOZU SOL VE SAĞ MOTOR TAKOZU	Yön : Sol Ve Sağ Ağırlık : 0.21 kg / 0.463 lb Malzeme Türü : Motor Takozu	5Q0198037, 5Q0199868 5QD199868
	<b>AU12026</b> MOTOR TAKOZU ÖN SOL VE SAĞ	Şasi (Ön / Arka) : ÖN Yön : Sol Ve Sağ Ağırlık : 0,850 kg / 1.874 lb	5Q0199855AD, 5Q0199855J 5Q0199855P, 5Q0199855Q
	<b>VW12086</b> RADYATÖR TAKOZU SOL VE SAĞ RADYATÖR ÜST LASTİĞİ	Yön : Sol Ve Sağ Ağırlık : 0.024 kg / 0.053 lb Not : RADYATÖR ÜST LASTİĞİ	1K0121367F

**RIW<sup>®</sup>**

**NOTLAR**

Ürün Kodu	Bilgi Notu
<b>AU1001</b> ROTİL SAĞ-SOL ALT RB2511	ONLY: 1972 - 1976
<b>AU1002</b> ROTİL ÖN SAĞ - SOL RB2512	MANUAL STEERING
<b>AU1005</b> ROTİL ÖN SAĞ RB2517	POWER STEERING
<b>AU1006</b> ROTİL ÖN SOL RB2516	POWER STEERING
<b>AU1007</b> ROTİL SAĞ RB2521	MANUAL STEERING
<b>AU1008</b> ROTİL SOL RB2520	MANUAL STEERING
<b>AU1009</b> ROTİL SAĞ RB2523	ONLY: 2.2 - 2.3cc
<b>AU1010</b> ROTİL SOL RB2522	ONLY: 2.2 - 2.3cc
<b>AU1013</b> ROTİL ÖN ALT SAĞ - SOL Ø15,5 RB2535	FOR QUATTRO A3-S3 ONLY: 2001 -
<b>AU1014K</b> ROTİL ÖN SAĞ Ø15 RB2530	WITH CONNECTING METAL
<b>AU1015K</b> ROTİL ÖN SOL Ø15 RB2529	WITH CONNECTING METAL
<b>AU11007</b> SALINCAK VE DENGİ KOLU BURCU ÖN ALT SOL VE SAĞ	HYDROLIC
<b>AU11008</b> SALINCAK VE DENGİ KOLU BURCU ARKA SOL VE SAĞ	CH. NO:--> 4A-N-000 001
<b>AU11013K</b> SALINCAK VE DENGİ KOLU BURCU ÖN ORTA SOL VE SAĞ	2 Pieces
<b>AU11038</b> BEŞİK (TRAVERS) BURCU SOL VE SAĞ	ONLY: 100 (1,4 - 2,8) and 200 (1,8 - 2,0) 1988 -
<b>AU11061</b> SALINCAK VE DENGİ KOLU BURCU ARKA SOL VE SAĞ	ONLY: 1996 - 2001
<b>AU11090</b> SALINCAK VE DENGİ KOLU BURCU ÖN ALT	HYDRAULIC



Ürün Kodu	Bilgi Notu
<b>AU11091</b> ROTMİLİ BURCU VE LASTİĞİ	SEMI-FINISHED PRODUCT
<b>AU11092</b> SALINCAK VE DENGE KOLU BURCU ÖN ALT ARKADAN	WITH HYDRO SB
<b>AU12004</b> VİRAJ DEMİR LASTİĞİ SOL VE SAĞ RUBBER	INTERNAL DIAMETER=Ø29mm
<b>AU12007K</b> VİRAJ DEMİR LASTİĞİ SOL VE SAĞ RUBBER	ONLY: 80 1,3 - 2,23
<b>AU12008</b> VİRAJ DEMİR LASTİĞİ SOL VE SAĞ RUBBER	ONLY: 1,6 - 2,8
<b>AU12008K</b> VİRAJ DEMİR LASTİĞİ SOL VE SAĞ RUBBER	ONLY: 1,6 - 2,8
<b>AU12012</b> EGZOZ TAKOZU ÖN SOL VE SAĞ EGSOZ LASTİĞİ	FOR EXHAUST SYSTEM
<b>AU12018</b> VİRAJ DEMİR LASTİĞİ SOL VE SAĞ	ONLY: 1,6 - 2,3 / 1977 - 1987
<b>AU12018K</b> VİRAJ DEMİR LASTİĞİ SOL VE SAĞ	ONLY: 1,6 - 2,3 / 1977 - 1987
<b>AU12019K</b> MOTOR TAKOZU SOL VE SAĞ MOTOR TAKOZU TAKIM	KIT = AU12019 and AU12020
<b>AU12025</b> AMORTİSÖR TAKOZU WITHOUT AWD	WITHOUT AWD
<b>AU12026</b> MOTOR TAKOZU ÖN SOL VE SAĞ	AUDI A3 : 1,6 TDI - 2,0 TDI / AUDI TT : 1,8 TFSI - 2,0 TFSI / SEAT LEON: PDT - PFL - PFN / VW GOLF VII AND TOURAN : 1,4 TSI - 1,6 TDI - 2,0 TSI - 2,0 TDI / VW TOURAN : 1,6 TDI - 2,0 TDI / SEAT ATECA : 1,0 TSI - 1,6 TDI - 2,0 TDI /
<b>AU12031</b> MOTOR TAKOZU ÖN SOL	FOR 2.0 TFSI
<b>AU12035</b> ŞANZİMAN TAKOZU	HYDRAULIC
<b>AU12049</b> VİRAJ DEMİR LASTİĞİ	Ø26mm
<b>AU12049K</b> VİRAJ DEMİR LASTİĞİ	2 PIECES in 1 BOX / Ø26mm
<b>AU12050</b> VİRAJ DEMİR LASTİĞİ	Ø23,5mm

Ürün Kodu	Bilgi Notu
<b>AU12050K</b> VİRAJ DEMİR LASTİĞİ	2 PIECES in 1 BOX / Ø23,5mm
<b>AU14001</b> AKS KÖRÜĞÜ +KELEPÇE+YAĞ.	SET = BELOW, CLAMPING CLIP and MOLYBDENUM GREASE
<b>AU20093001</b> ROT TAKIMI SAĞ	CH. NO: 8L.W-050-423 -->
<b>AU20103001</b> ROT TAKIMI SOL	CH. NO: 8L.W-050-423 -->
<b>AU20113015</b> ROT TAKIMI ÖN SAĞ	ONLY SPORT SUSPENSION
<b>AU20113015</b> ROT TAKIMI ÖN SAĞ	ONLY SPORT SUSPENSION
<b>AU20123015</b> ROT TAKIMI ÖN SOL	ONLY SPORT SUSPENSION
<b>AU20123015</b> ROT TAKIMI ÖN SOL	ONLY SPORT SUSPENSION
<b>AU20123015</b> ROT TAKIMI ÖN SOL	ONLY SPORT SUSPENSION
<b>AU2214</b> ROTBAŞI ÖN SAĞ - SOL RB2214	CH. NO: .-> 8D-W-260192 -> 8D-W-152089
<b>AU2214A</b> ROTBAŞI SAĞ-SOL (KOMPLE DEMİR) RB2225	YEAR: 2001-->
<b>AU2214A3002</b> ROT TAKIMI ÖN AKS RB288136	YEAR: 2001-->
<b>AU2318</b> ROTBAŞI SOL KISA RB2318	CH. NO:-->8L-W-050-422
<b>AU23183003</b> ROT TAKIMI SAĞ RB288113	CH. NO:--> 8L-W-050-422
<b>AU2319</b> ROTBAŞI SAĞ KISA RB2319	CH. NO:--> 8L-W-050-422
<b>AU23193003</b> ROT TAKIMI SOL RB288112	CH. NO:--> 8L-W-050-422
<b>AU3001</b> ROTMİLİ SOL VE SAĞ 318 RD0908	CH. NO: 8L-W-050-423 ->
<b>AU3003</b> ROTMİLİ SAĞ-SOL UZUN L 360 MM RB2811	CHASSIS: -> 8L-W-050-422

Ürün Kodu	Bilgi Notu
<b>AU3015</b> ROTMİLİ ÖN SAĞ - SOL	ONLY SPORT SUSPENSION
<b>AU3015</b> ROTMİLİ ÖN SAĞ - SOL	ONLY SPORT SUSPENSION
<b>AU3017</b> ROTMİLİ 330	POWER STEERING
<b>AU4008</b> Z ROT ÖN SAĞ ALİMİNYUM 90 RB2921	WITH BOLTS and NUTS
<b>AU4009</b> Z ROT ÖN SOL ALİMİNYUM 90 RB2920	WITH BOLTS and NUTS
<b>AU4010</b> Z ROT ÖN SAĞ-SOL ALİMİNYUM 90 RB2912	WITH BOLTS and NUTS
<b>AU4014</b> Z ROT ÖN SAĞ ALİMİNYUM 90 RB2926	YEAR: 2000--->
<b>AU4015</b> Z ROT ÖN SOL ALİMİNYUM 90 RB2927	YEAR: 2000--->
<b>AU4016</b> Z ROT SOL VE SAĞ METAL	YEAR: 2000--->
<b>AU4032</b> Z ROT ÖN SAĞ - SOL	ACTIVE SUSPENSION
<b>AU4034</b> Z ROT ÖN SAĞ-SOL	FOR ARMOURED VEHICLES
<b>AU4042</b> Z ROT SAĞ METAL	CHASSIS NO FROM 4L8030301
<b>AU4043</b> Z ROT SOL METAL	CHASSIS NO FROM 4L8030301
<b>AU5001</b> SALINCAK ÖN SAĞ RB2612	MANUAL STEERING
<b>AU5002</b> SALINCAK ÖN SOL RB2611	MANUAL STEERING
<b>AU5003</b> SALINCAK ÖN SAĞ	POWER STEERING
<b>AU5004</b> SALINCAK ÖN SOL	POWER STEERING

Ürün Kodu	Bilgi Notu
<b>AU5007A</b> SALINCAK ÖN ÜST SAĞ RB2629	CH. NO: 8D-W-006471 --> and 8D-X-200001 -->
<b>AU5008A</b> SALINCAK ÖN ÜST SOL RB2628	CH. NO: 8D-W-006471 --> and 8D-X-200001 -->
<b>AU5009A</b> SALINCAK ÖN ÜST SAĞ RB2635	CH. NO: 8D-W-006471 --> and 8D-X-200001 -->
<b>AU5010A</b> SALINCAK ÖN ÜST SOL RB2634	CH. NO: 8D-W-006471 --> and 8D-X-200001 -->
<b>AU5014</b> SALINCAK ARKA RB2625	ONLY: 1995-1997
<b>AU5015</b> SALINCAK ARKA RB2624	ONLY: 1996-2001
<b>AU5037</b> SALINCAK ÖN ÜST SAĞ	REARWARD
<b>AU5038</b> SALINCAK ÖN ÜST SOL	REARWARD
<b>AU5053</b> SALINCAK ÖN SAĞ	REARWARD
<b>AU5054</b> SALINCAK ÖN SOL	REARWARD
<b>AU5056</b> SALINCAK ÖN SAĞ ALT	REARWARD
<b>AU5057</b> SALINCAK ÖN SOL ALT	REARWARD
<b>AU5060</b> SALINCAK ÖN ALT	FORWARD
<b>AU5061</b> SALINCAK ÖN ALT	FORWARD
<b>AU5064</b> SALINCAK ÖN ALT SAĞ	FORWARD
<b>AU5065</b> SALINCAK ÖN ALT SOL	FORWARD
<b>AU5066</b> SALINCAK ÖN SAĞ ÜST	REARWARD

Ürün Kodu	Bilgi Notu
<b>AU5067</b> SALINCAK ÖN SOL ÜST	REARWARD
<b>AU5068</b> SALINCAK ÖN SAĞ ÜST	FORWARD
<b>AU5069</b> SALINCAK ÖN SOL ÜST	FORWARD
<b>AU5071</b> SALINCAK ÖN ALT ARKADAN SAĞ	ALUMINUM
<b>AU5071</b> SALINCAK ÖN ALT ARKADAN SAĞ	ALUMINUM
<b>AU5072</b> SALINCAK ÖN ALT ARKADAN SOL	ALUMINUM
<b>AU5072</b> SALINCAK ÖN ALT ARKADAN SOL	ALUMINUM
<b>AU5073</b> SALINCAK ÖN ALT SAĞ	AUDI A4 and AUDI A5 YEAR ONLY: 2011-2015
<b>AU5073</b> SALINCAK ÖN ALT SAĞ	AUDI A4 and AUDI A5 YEAR ONLY: 2011-2015
<b>AU5074</b> SALINCAK ÖN ALT SOL	AUDI A4 and AUDI A5 YEAR ONLY: 2011-2015
<b>AU5074</b> SALINCAK ÖN ALT SOL	AUDI A4 and AUDI A5 YEAR ONLY: 2011-2015
<b>AU5085</b> SALINCAK ÖN ÜST ÖNDEN SAĞ	ONLY FOR SPORT SUSPENSION
<b>AU5086</b> SALINCAK ÖN ÜST ÖNDEN SOL	ONLY FOR SPORT SUSPENSION
<b>AU5087</b> SALINCAK ÖN ÜST ARKADAN SAĞ	ONLY FOR SPORT SUSPENSION
<b>AU5088</b> SALINCAK ÖN ÜST ARKADAN SOL	ONLY FOR SPORT SUSPENSION
<b>AU5089</b> SALINCAK VE DENGE KOLU ÖN ALT ARKADAN SAĞ	WITH HYDRO SB
<b>AU5090</b> SALINCAK VE DENGE KOLU ÖN ALT ARKADAN SOL	WITH HYDRO SB

Ürün Kodu	Bilgi Notu
<b>AU6013A</b> SALINCAK ÖN ALT SAĞ	CH. NO: --> 8Z-3-019-682
<b>AU6014A</b> SALINCAK ÖN ALT SOL	CH. NO: --> 8Z-3-019-682
<b>AU6027</b> SALINCAK ÜST	YEARS ONLY: 2011-2015
<b>AU8001</b> SÜSPANSİYON KİT ÖN	AU2214 (X2) / AU5013 (X2) / OTHER (X1)
<b>AU8002</b> SÜSPANSİYON KİT ÖN	AU2214 (X2) / AU5013B (X2) / OTHER (X1)
<b>AU8003</b> SÜSPANSİYON KİT ÖN	AU2214A (X2) / AU5013A (X2) / OTHER (X1)
<b>AU8004</b> SÜSPANSİYON KİT ÖN	AU2214 (X2) / AU5013 (X2) / OTHER (X1)
<b>AU8005</b> SÜSPANSİYON KİT ÖN	AU4026 (X2) / AU3007 (X2) / OTHER (X1)
<b>AU8006</b> SÜSPANSİYON KİT ÖN	AU2217 (X2) / AU4019 (X2) / OTHER (X1)
<b>AU9008</b> SALINCAK ARKA ALT	REARWARD
<b>AU9010</b> SALINCAK ARKA ÜST SAĞ	REARWARD
<b>AU9011</b> SALINCAK ARKA ÜST SOL	REARWARD
<b>AU9020</b> SALINCAK ARKA ALT ARKADAN SAĞ	WITH AIR SUSPENSION
<b>AU9023</b> SALINCAK ARKA ALT ÖNDEN SAĞ	ONLY FOR S1 & QUATTRO / YEARS ONLY: 2014-2018
<b>AU9024</b> SALINCAK ARKA ALT ÖNDEN SOL	ONLY FOR S1 & QUATTRO / YEARS ONLY: 2014-2018
<b>AU9031</b> SALINCAK VE DENGE KOLU ARKA ÜST SAĞ ALÜMİNYUM	FOR AIR SUSPENSION
<b>AU9032</b> SALINCAK VE DENGE KOLU ARKA ÜST SOL ALÜMİNYUM	FOR AIR SUSPENSION

Ürün Kodu	Bilgi Notu
<b>FI14009</b> AKS KÖRÜĞÜ +KELEPÇE+YAĞ. DIŞ	SET = BELOW, CLAMPING CLIP and MOLYBDENUM GREASE / 1.9JTD
<b>FI14014</b> AKS KÖRÜĞÜ +KELEPÇE+YAĞ. DIŞ	SET = BELOW, CLAMPING CLIP, MOLYBDENUM GREASE / 1.3
<b>OP14003</b> AKS KÖRÜĞÜ +KELEPÇE+YAĞ. AKS KÖRÜĞÜ DIŞ	SET = BELOW, CLAMPING CLIP and MOLYBDENUM GREASE / OUTER
<b>OP14017</b> AKS KÖRÜĞÜ +KELEPÇE+YAĞ. DIŞ	SET = BELOW, CLAMPING CLIP and MOLYBDENUM GREASE / OUTER
<b>RN14006</b> AKS KÖRÜĞÜ +KELEPÇE+YAĞ. DIŞ	SET = BELOW, CLAMPING CLIP and MOLYBDENUM GREASE / OUTER
<b>RN14016</b> AKS KÖRÜĞÜ +KELEPÇE+YAĞ. DIŞ	SET = BELOW, CLAMPING CLIP and MOLYBDENUM GREASE / OUTER
<b>SE12001</b> MOTOR TAKOZU ÖN SOL VE SAĞ	AUDI A1 YEARS ONLY: 2014-2018 / SEAT IBIZA ONLY: IV 2015-2017 / 1,4 TDI / VOLKSWAGEN POLO YEARS ONLY: 2014 -
<b>SE12004</b> MOTOR TAKOZU ÖN SOL VE SAĞ	AUDI A1 YEARS ONLY: 2014-2018 / SEAT IBIZA ONLY: IV 2015-2017 / 1,4 TDI / VOLKSWAGEN POLO YEARS ONLY: 2014 -
<b>SK12002</b> AMORTİSÖR TAKOZU ARKA SOL VE SAĞ 1.2 / 1.4TSI / 1.6TDI / 1.2TDI	1.2 / 1.4TSI / 1.6TDI / 1.2TDI
<b>SK12003K</b> VİRAJ DEMİR LASTİĞİ SOL VE SAĞ RUBBER	2 PIECES IN 1 BOX
<b>SK12005</b> MOTOR TAKOZU ÖN SAĞ	FOR 1.0 TSI
<b>VW1014</b> ROTİL ÖN ALT SAĞ Ø15,6 RB2536	WITH ENFORCEMENT METAL
<b>VW11043B</b> SALINCAK VE DENGİ KOLU BURCU SAĞ	WITHOUT BUSH
<b>VW11044B</b> SALINCAK VE DENGİ KOLU BURCU SOL	WITHOUT BUSH
<b>VW11052</b> SALINCAK VE DENGİ KOLU BURCU ALT SOL VE SAĞ B22130	ONLY: A4 - A6 > 1,6-1,8 / PASSAT > 1,6 - 2,8 *
<b>VW11055</b> SALINCAK VE DENGİ KOLU BURCU İÇ SOL VE SAĞ	ONLY FOR MEXICO MARKET
<b>VW11075</b> SALINCAK VE DENGİ KOLU BURCU ARKA SOL VE SAĞ	FORWARD and INNER

Ürün Kodu	Bilgi Notu
<b>VW11076</b> SALINCAK VE DENGELER KOLU BURCU ARKA SOL VE SAĞ	FORWARD and OUTER
<b>VW12020K</b> VİRAJ DEMİR LASTİĞİ SOL VE SAĞ RUBBER	2 PCS
<b>VW12029</b> MOTOR TAKOZU SOL VE SAĞ MOTOR TAKOZU	1,4 TFSI -1,6 TFSI
<b>VW12030</b> MOTOR TAKOZU SOL VE SAĞ MOTOR TAKOZU ARKA	1,6-1,8
<b>VW12031</b> MOTOR TAKOZU SOL VE SAĞ MOTOR TAKOZU	A4: 2,4-2,8 / A6: 2,4 QUATTRO / SUPERB: 2,8 V6 / PASSAT: 2,8 V6
<b>VW12032</b> MOTOR TAKOZU SOL VE SAĞ MOTOR TAKOZU	A3: 2,0 FSI / ALTEA: 2,0 FSI / TOLEDO: 2,0 FSI / OCTAVIA: 2,0 FSI / CADDY: 2,0 FSI / GOLF: 2,0 TDI / GTI: 2,0 TDI / JETTA: 2,0 TDI / PASSAT: 2,0 FSI / TOURAN: 2,0 FSI
<b>VW12048K</b> VİRAJ DEMİR LASTİĞİ SOL VE SAĞ RUBBER	2 PCS
<b>VW12049K</b> VİRAJ DEMİR LASTİĞİ SOL VE SAĞ RUBBER	2 PCS
<b>VW12052K</b> VİRAJ DEMİR LASTİĞİ SOL VE SAĞ RUBBER	2 PCS
<b>VW12061K</b> AMORTİSÖR TAKOZU SOL VE SAĞ 2 PCS	2 PCS
<b>VW12064K</b> VİRAJ DEMİR LASTİĞİ SOL VE SAĞ RUBBER	2 PCS / D=Ø21mm
<b>VW12064K</b> VİRAJ DEMİR LASTİĞİ SOL VE SAĞ RUBBER	2 PCS / D=Ø21mm
<b>VW12086</b> RADYATÖR TAKOZU SOL VE SAĞ RADYATÖR ÜST LASTİĞİ	FOR RADIATOR UPPER PART
<b>VW12087K</b> VİRAJ DEMİR LASTİĞİ SOL VE SAĞ RUBBER	2 PCS
<b>VW12104K</b> AMORTİSÖR TAKOZU SOL VE SAĞ 2 PCS	2 PCS
<b>VW12109K</b> AMORTİSÖR TAKOZU SOL VE SAĞ 2 PCS	2 PCS
<b>VW12117K</b> VİRAJ DEMİR LASTİĞİ SOL VE SAĞ RUBBER	2 PCS



Ürün Kodu	Bilgi Notu
<b>VW12137</b> VİRAJ DEMİR LASTİĞİ	Ø17mm
<b>VW12137K</b> VİRAJ DEMİR LASTİĞİ	2 PIECES in 1 BOX / Ø17mm
<b>VW12801</b> AMORTİSÖR TAKOZU SOL VE SAĞ KİT = VW12115 AND VW12109	KİT = VW12115 and VW12109
<b>VW13002K</b> DİREKSİYON KÖRÜĞÜ SOL VE SAĞ 2 PIECES	2 Pieces
<b>VW13006K</b> DİREKSİYON KÖRÜĞÜ SOL VE SAĞ 2 PIECES	2 Pieces
<b>VW14001</b> AKS KÖRÜĞÜ +KELEPÇE+YAĞ. DIŞ	SET = BELOW, CLAMPING CLIP and MOLYBDENUM GREASE / OUTER
<b>VW14003</b> AKS KÖRÜĞÜ +KELEPÇE+YAĞ. DIŞ	SET = BELOW, CLAMPING CLIP and MOLYBDENUM GREASE / OUTER
<b>VW14008</b> AKS KÖRÜĞÜ +KELEPÇE+YAĞ. DIŞ	SET = BELOW, CLAMPING CLIP and MOLYBDENUM GREASE / OUTER
<b>VW14009</b> AKS KÖRÜĞÜ +KELEPÇE+YAĞ. DIŞ	SET = BELOW, CLAMPING CLIP and MOLYBDENUM GREASE / OUTER
<b>VW14011</b> AKS KÖRÜĞÜ +KELEPÇE+YAĞ. İÇ	SET = BELOW, CLAMPING CLIP and MOLYBDENUM GREASE / INNER
<b>VW14012</b> AKS KÖRÜĞÜ +KELEPÇE+YAĞ. DIŞ	SET = BELOW, CLAMPING CLIP and MOLYBDENUM GREASE / OUTER
<b>VW14013</b> AKS KÖRÜĞÜ +KELEPÇE+YAĞ. YAĞ+KELEPÇE	SET = BELOW, CLAMPING CLIP and MOLYBDENUM GREASE
<b>VW14014</b> AKS KÖRÜĞÜ +KELEPÇE+YAĞ. YAĞ+KELEPÇE	SET = BELOW, CLAMPING CLIP and MOLYBDENUM GREASE
<b>VW2031</b> ROTBAŞI SAĞ	FOR VEHICLES WITH DYNAMIC STEERING
<b>VW2032</b> ROTBAŞI SOL	FOR VEHICLES WITH DYNAMIC STEERING
<b>VW4015K</b> Z ROT SOL VE SAĞ METAL	WITH NUT and SCREW
<b>VW4035</b> Z ROT ARKA PLASTİK	TRIM LEVEL : MULTILINK REAR AXLE

Ürün Kodu	Bilgi Notu
<b>VW5004</b> SALINCAK ARKA ÜST	FORWARD
<b>VW6016</b> SALINCAK ÖN SAĞ RD10227	ONLY: GASOLINE
<b>VW6016J</b> SALINCAK ÖN ALT SAĞ S737	ONLY: GASOLINE
<b>VW6017</b> SALINCAK ÖN SOL RD10226	ONLY: GASOLINE
<b>VW6017J</b> SALINCAK ÖN ALT SOL S738	ONLY: GASOLINE
<b>VW6018</b> SALINCAK ÖN SAĞ RB30219	ONLY: DIESEL
<b>VW6018J</b> SALINCAK ÖN SAĞ RB30211	ONLY: DIESEL
<b>VW6019</b> SALINCAK ÖN SOL RB30218	ONLY: DIESEL
<b>VW6019J</b> SALINCAK ÖN SOL RB30212	ONLY: DIESEL
<b>VW6063</b> SALINCAK ÖN ALT SAĞ	1.0 TSI
<b>VW6063</b> SALINCAK ÖN ALT SAĞ	1.0 TSI
<b>VW6063J</b> SALINCAK ÖN ALT SAĞ	1.0 TSI
<b>VW6063J</b> SALINCAK ÖN ALT SAĞ	1.0 TSI
<b>VW6064</b> SALINCAK ÖN ALT SOL	1.0 TSI
<b>VW6064</b> SALINCAK ÖN ALT SOL	1.0 TSI
<b>VW6064J</b> SALINCAK ÖN ALT SOL	1.0 TSI
<b>VW6064J</b> SALINCAK ÖN ALT SOL	1.0 TSI

Ürün Kodu	Bilgi Notu
<b>VW6067</b> SALINCAK ALT SAĞ	RUSSIA MARKET / PORSCHE CAYENNE YEARS ONLY: 2008-2010 / VOLKSWAGEN TOUAREG YEARS ONLY: 2008-2010
<b>VW6068</b> SALINCAK ALT SOL	RUSSIA MARKET / PORSCHE CAYENNE YEARS ONLY: 2008-2010 / VOLKSWAGEN TOUAREG YEARS ONLY: 2008-2010
<b>VW8001</b> SÜSPANSİYON KİT ÖN	AU3001 (X2) / VW4011 (X2) / OTHERS (X1)
<b>VW8002</b> SÜSPANSİYON KİT ÖN	VW3009 (X2) / VW4014 (X2) / OTHERS (X1)
<b>VW8003</b> SÜSPANSİYON KİT ÖN	KIT = AU1014 (X1) / AU1015 (X1) / VW4011 (X2) / AU11002 (X2) / AU11005 (X2)
<b>VW9005</b> SALINCAK ARKA ALT ÖNDEN	FORWARD