

# RIW

STEERING & SUSPENSION  
MANUFACTURER



## SEAT PRODUCT CATALOG



### Products

- Ball Joint
- Tie Rod End
- Axial Joint
- Link Stabilizer
- Control Arm
- Center Rod
- Stabilizer Mounting
- Suspension Kit
- Bush
- Tie Rod Assembly
- Mounting
- Steering Bellow
- Axle Bellow



### Hakkımızda

RIW, otomotiv yedek parça yenileme sektöründe binek ve hafif ticari araçların süspansiyon ve direksiyon parçalarını yüksek kalitede üreten ve son kullanıcının aracını güvenle kullanmasını amaçlayan ayrıca otomotiv endüstrisine ve ülke ekonomisine fayda sağlamayı kendine ilke edinen bir organizasyondur. Rotil, rotbaşı, rotmili, rot-takımı, zrot, askı rotu, ara rot, denge kolu, salıncak, burç, kauçuk ve takoz ürünlerinin montaj ve üretimlerini gerçekleştiren RIW, dünyadaki en geniş ürün çeşitliliğine sahip süspansiyon ve direksiyon parçaları üreticilerinden biridir.

Ürün çeşitliliğinin genişliği, yüksek ürün kalitesi, uygun fiyatları ve müşteri odaklı çalışmaları sonucunda Türkiye'nin en büyük yedek parça firmaları arasında yer almaktadır. Binek ve hafif ticari araçların süspansiyon ve direksiyon parçaları üretiminde Araştırma ve Geliştirme odaklı çalışmalarını en ileri ve teknolojik şartlarda yürütülmesiyle RIW Türkiye'nin en modern yedek parça üreticisidir.

RIW, firma kültüründe, teknoloji, kalite ve müşteri memnuniyetini ön planda tutularak, Türkiye'de ve dünyanın birçok ülkesinde pazarın güvenle tedarik ettiği bir markadır. RIW, modern üretim tesislerinde bulunan son teknoloji makina parkı avantajıyla tasarımdan üretime, üretimden kaliteye, paketlenmeden sevkiyata, pazarlamadan satışa bütün operasyonel aşamaların yanı sıra satış sonrası hizmetlerini ve bütün bunları sağlarken göz önünde bulundurduğu çalışan memnuniyeti ve güvenliğini her zaman iyiye ve ileriye götürme prensibi sayesinde Dünya genelinde 60 'ın üzerinde ülkede saygı değer bir marka olmayı başarmıştır.

### Misyon

Dünya otomotiv yenileme sektörüne yüksek kalitede ve pazarda her zaman ilk kez geliştirilen ürünleri sunmak ve ayrıca pazardaki ürün kalitesini yükseltmek.

### Vizyon

İleri teknoloji ve sektörel deneyimin ortaya çıkardığı "RIW Standartlarından" bütün dünyanın faydalanması.

### Üretim Stratejisi

Ürün dizaynı, kalıp tasarımı, talaşlı imalat, sıcak ve soğuk dövme, alüminyum dövme, dikey ve yatay kol işleme, salıncak imalatı, kaynak, boyama, kaplama ve paketlenmeden oluşan çeşitli üretim aşamaları hemen hemen her bölümün kendi tesisinde RIW mühendislerinin kontrolünde gerçekleşir. RIW üretimdeki her aşamayı farklı bir ünite olarak kabul eder ve müşteriye en hızlı ve en kaliteli ürünü sunmak için her birimin kendi planlamasını ayrı bir birim olarak hareket etmesi tezini savunur. Bu sayede büyük sermayelere ulaşmanın zor olduğu rekabetçi Pazar şartlarında RIW yatırımlarını kalitenin kontrolü ve yükseltilmesi doğrultusunda gerçekleştirir.

Üretimdeki her aşamanın bir çatı altında toplanmasını amaçlayan zihniyetin tam tersine RIW deneyimli mühendisleri sayesinde hammadde ve yarı mamül tedarikçilerinin sürekli denetlenmesini sağlar ve bu sayede kaliteyi her zaman kontrol altında tutar. Bu sistemle kalite testlerinin her aşamada uygulanması için kullanılan son teknoloji makine ve test cihazları sayesinde RIW müşterisine her zaman %100 kontrol edilmiş ürünler sunar ve ayrıca hem hata riskini sıfıra indirir hem de üretilen mamüllerin maliyetlerini düşürerek müşterisine en yüksek kaliteyi en uygun ve rekabetçi fiyatlarda sunmayı hedefler.

### Toplam Kalite Anlayışı

Toplam kalite anlayışını kendine amaç edinen RIW, yapılan yatırımlar ve kalite çalışmaları sonucunda, üretim kapasitesini devamlı arttırmış ve dünya pazarında aranan bir marka haline gelmiştir. Güvenlik parçaları üreticisi olmak bilinciyle hareket eden RIW, yüksek kalitedeki ürünlerini Avrupa, Kuzey Afrika, Ortadoğu, Avustralya, Kuzey ve Güney Amerika da yer alan birçok ülkeye aktif olarak ihraç etmektedir.

Üretimin başlangıcından bitimine kadar olan tüm aşamalarda RIW, ürünlerinin kalitesini yakından takip etmekte ve müşterilerine güvenilir ve yüksek kaliteli ürünlerin sunulduğundan emin olmaktadır. Doğru kaliteyi buluna kadar bütün testler ve işlemler, yüksek deneyime sahip RIW mühendisleri tarafından uygulanmaktadır.

### Hakkımızda

RIW, otomotiv yedek parça yenileme sektöründe binek ve hafif ticari araçların süspansiyon ve direksiyon parçalarını yüksek kalitede üreten ve son kullanıcının aracını güvenle kullanmasını amaçlayan ayrıca otomotiv endüstrisine ve ülke ekonomisine fayda sağlamayı kendine ilke edinen bir organizasyondur. Rotil, rotbaşı, rotmili, rot-takımı, zrot, askı rotu, ara rot, denge kolu, salıncak, burç, kauçuk ve takoz ürünlerinin montaj ve üretimlerini gerçekleştiren RIW, dünyadaki en geniş ürün çeşitliliğine sahip süspansiyon ve direksiyon parçaları üreticilerinden biridir.

Ürün çeşitliliğinin genişliği, yüksek ürün kalitesi, uygun fiyatları ve müşteri odaklı çalışmaları sonucunda Türkiye'nin en büyük yedek parça firmaları arasında yer almaktadır. Binek ve hafif ticari araçların süspansiyon ve direksiyon parçaları üretiminde Araştırma ve Geliştirme odaklı çalışmalarını en ileri ve teknolojik şartlarda yürütülmesiyle RIW Türkiye'nin en modern yedek parça üreticisidir.

RIW, firma kültüründe, teknoloji, kalite ve müşteri memnuniyetini ön planda tutularak, Türkiye'de ve dünyanın birçok ülkesinde pazarın güvenle tedarik ettiği bir markadır. RIW, modern üretim tesislerinde bulunan son teknoloji makina parkı avantajıyla tasarımdan üretime, üretimden kaliteye, paketlenmeden sevkiyata, pazarlamadan satışa bütün operasyonel aşamaların yanı sıra satış sonrası hizmetlerini ve bütün bunları sağlarken göz önünde bulundurduğu çalışan memnuniyeti ve güvenliğini her zaman iyiye ve ileriye götürme prensibi sayesinde Dünya genelinde 60 'ın üzerinde ülkede saygı değer bir marka olmayı başarmıştır.

### Misyon

Dünya otomotiv yenileme sektörüne yüksek kalitede ve pazarda her zaman ilk kez geliştirilen ürünleri sunmak ve ayrıca pazardaki ürün kalitesini yükseltmek.

### Vizyon

İleri teknoloji ve sektörel deneyimin ortaya çıkardığı "RIW Standartlarından" bütün dünyanın faydalanması.

### Üretim Stratejisi

Ürün dizaynı, kalıp tasarımı, talaşlı imalat, sıcak ve soğuk dövme, alüminyum dövme, dikey ve yatay kol işleme, salıncak imalatı, kaynak, boyama, kaplama ve paketlenmeden oluşan çeşitli üretim aşamaları hemen hemen her bölümün kendi tesisinde RIW mühendislerinin kontrolünde gerçekleşir. RIW üretimdeki her aşamayı farklı bir ünite olarak kabul eder ve müşteriye en hızlı ve en kaliteli ürünü sunmak için her birimin kendi planlamasını ayrı bir birim olarak hareket etmesi tezini savunur. Bu sayede büyük sermayelere ulaşmanın zor olduğu rekabetçi Pazar şartlarında RIW yatırımlarını kalitenin kontrolü ve yükseltilmesi doğrultusunda gerçekleştirir.

Üretimdeki her aşamanın bir çatı altında toplanmasını amaçlayan zihniyetin tam tersine RIW deneyimli mühendisleri sayesinde hammadde ve yarı mamül tedarikçilerinin sürekli denetlenmesini sağlar ve bu sayede kaliteyi her zaman kontrol altında tutar. Bu sistemle kalite testlerinin her aşamada uygulanması için kullanılan son teknoloji makine ve test cihazları sayesinde RIW müşterisine her zaman %100 kontrol edilmiş ürünler sunar ve ayrıca hem hata riskini sıfıra indirir hem de üretilen mamüllerin maliyetlerini düşürerek müşterisine en yüksek kaliteyi en uygun ve rekabetçi fiyatlarda sunmayı hedefler.

### Toplam Kalite Anlayışı

Toplam kalite anlayışını kendine amaç edinen RIW, yapılan yatırımlar ve kalite çalışmaları sonucunda, üretim kapasitesini devamlı arttırmış ve dünya pazarında aranan bir marka haline gelmiştir. Güvenlik parçaları üreticisi olmak bilinciyle hareket eden RIW, yüksek kalitedeki ürünlerini Avrupa, Kuzey Afrika, Ortadoğu, Avustralya, Kuzey ve Güney Amerika da yer alan birçok ülkeye aktif olarak ihraç etmektedir.

Üretimin başlangıcından bitimine kadar olan tüm aşamalarda RIW, ürünlerinin kalitesini yakından takip etmekte ve müşterilerine güvenilir ve yüksek kaliteli ürünlerin sunulduğundan emin olmaktadır. Doğru kaliteyi buluna kadar bütün testler ve işlemler, yüksek deneyime sahip RIW mühendisleri tarafından uygulanmaktadır.

- The codes which has 6 characters are suspension parts (Additional codes are exceptional)
- The codes which has 7 characters are rubber parts (Additional codes are exceptional)
- There is no any specific code for Rod Assembly.
- Rod Assembly codes are the combine of Tie Rod End and Axial Joint.
- Same parts which are used at the different cars might have the same code.

## PE 6 001 J

### Brand

<b>AC</b> ACURA	<b>DC</b> DACIA	<b>IS</b> ISUZU	<b>LE</b> LEYLAND	<b>PE</b> PEUGEOT	<b>SM</b> SMART
<b>AF</b> ALFA ROMEO	<b>DW</b> DAEWOO	<b>IV</b> IVECO	<b>LC</b> LINCOLN	<b>PO</b> PORSCHE	<b>SY</b> SSANGYONG
<b>AU</b> AUDI	<b>DH</b> DAIHATSU	<b>JG</b> JAGUAR	<b>LO</b> LOTUS	<b>PR</b> PROTON	<b>SU</b> SUBARU
<b>BW</b> BMW	<b>DO</b> DODGE	<b>JP</b> JEEP	<b>MZ</b> MAZDA	<b>RE</b> RENAULT	<b>SZ</b> SUZUKI
<b>BU</b> BUICK	<b>FI</b> FIAT	<b>KI</b> KIA	<b>ME</b> MERCEDES	<b>RR</b> ROLLS-ROYCE	<b>TO</b> TOYOTA
<b>CD</b> CADILLAC	<b>FO</b> FORD	<b>LD</b> LADA	<b>MC</b> MINI COOPER	<b>RO</b> ROVER	<b>VA</b> VAUXHALL
<b>CV</b> CHEVROLET	<b>HN</b> HONDA	<b>LR</b> LAND ROVER	<b>MI</b> MITSUBISHI	<b>SA</b> SAAB	<b>VW</b> VOLKSWAGEN
<b>CY</b> CHRYSLER	<b>HY</b> HYUNDAI	<b>LV</b> LDV	<b>NS</b> NISSAN	<b>SE</b> SEAT	<b>VO</b> VOLVO
<b>CI</b> CITROËN	<b>IK</b> IKCO	<b>LX</b> LEXUS	<b>OP</b> OPEL	<b>SK</b> SKODA	

### Product Group

<b>1</b> BALL JOINT	<b>7</b> CENTER ROD & DRAG LINK	<b>23</b> TIE ROD ASSEMBLY
<b>2</b> TIE ROD END	<b>8</b> SUSPENSION KITS	<b>12</b> MOUNTING & RUBBER SUPPORT
<b>3</b> AXIAL JOINT (INNER TIE ROD)	<b>9</b> REAR WISHBONE AND CONTROL ARM	<b>128</b> MOUNTING or RUBBER SUPPORT KIT
<b>4</b> LINK STABILIZER	<b>10</b> BUSH	<b>13</b> BELLOWS STEERING
<b>5</b> CONTROL ARM	<b>11</b> BUSH	<b>14</b> BELLOWS DRIVE SHAFT
<b>6</b> WISHBONE	<b>118</b> REPAIR & BUSH KIT	

### Numbers

**001** Any Number ■

### Option







#### ADDITIONALS CODES AND MEANINGS

<b>K</b> K FOR BALL JOINTS	<b>B</b> B FOR WISHBONE and CONTROL ARMS
VW1012K 1 = BALL JOINT K = WITH EXTRA ACCESSORIES	BW5005B 5 = CONTROL ARM B = WITHOUT BUSHING
VW1012 1 = BALL JOINT	BW5005 5 = CONTROL ARM (The similar as OE part)
<b>J</b> J FOR WISHBONES	<b>K</b> K FOR MOUNTINGS (RUBBER PARTS)
PE6001J 6 = WISHBONE J = WITHOUT BALL JOINT	CV12005K 12 = MOUNTING K = KIT, 2 PIECES or WITH EXTRA ACCESSORIES
PE6001 6 = WISHBONE (The similar as the OE part)	CV12005 12 = MOUNTING (The similar as OE part)
<b>K</b> K FOR WISHBONES or CONTROL ARMS (5,6 or 9)	<b>A</b> THE PRODUCT HAS DIFFERENT OPTION
BW6005K 6 = WISHBONE K = WITH EXTRA ACCESSORIES	FO4030A 4 = LINK STABILIZER A = OPTION (metal, rubber), plastic etc)
BW6005 6 = WISHBONE	FO4030 4 = LINK STABILIZER (The similar as OE part)

**RIW<sup>®</sup>**

**SEAT**

**131 MIRAFIORI**
**1974 - 2001**

Resim	Ürün Kodu ve Açıklaması	Detay	OEM
	<b>FI1003</b> ROTİL SAĞ-SOL RB5412	Ağırlık : 0,395 kg / 0.871 lb Konik Ölçüsü : Ø14,5 Aşık Diş Çapı : M12X1,25 Rotil Gövde Çapı : Ø41,4	4322253, 4331439
	<b>FI2006</b> ROTBAŞI SOL VE SAĞ RB5321	Ağırlık : 0,346 kg / 0.763 lb Uzunluk : 75 mm / 2.95 inch Gövde Diş Çapı : M14X1,5 Aşık Diş Çapı : M10X1,5 Aşık Konik Çapı : Ø12,5	116002404100, 116002404101 4322905, 4322906 60521320, 60521321
	<b>FI2007</b> ROTBAŞI SAĞ-SOL RB5322	Ağırlık : 0,309 kg / 0.681 lb Uzunluk : 72 mm / 2.83 inch Gövde Diş Çapı : M12X1,5 Aşık Diş Çapı : M10X1,25 Aşık Konik Çapı : Ø12,6	5962772, 5962773
	<b>FI3001</b> ROTMİLİ MANUEL STR 284 MM 275 RB5814	Ağırlık : 0,607 kg / 1.338 lb Uzunluk : 280 mm / 11.02 inch Gövde Diş Çapı : M14X1,5 Aşık Diş Çapı : M14X1,5	4322913, SE022162449A
	<b>FI3001A</b> ROTMİLİ SAĞ-SOL 270	Ağırlık : 0,607 kg / 1.338 lb Uzunluk : 270 mm / 10.63 inch Gövde Diş Çapı : M14X1,5 Aşık Diş Çapı : M14X1,5	
	<b>FI3002</b> ROTMİLİ M12X1,5 L=285	Ağırlık : 0,515 kg / 1.135 lb Uzunluk : 285 mm / 11.22 inch Gövde Diş Çapı : M14X1,5 Aşık Diş Çapı : M12X1,15	59588244
	<b>FI3003</b> ROTMİLİ SLX SAĞ-SOL HİDROLİK 275 RB5822	Ağırlık : 0,575 kg / 1.268 lb Uzunluk : 264 mm / 10.39 inch Gövde Diş Çapı : M14X1,5 Aşık Diş Çapı : M14X1,5	15000099, 9939038 9940260



**FI8001 / Süspansiyon Kit Ön**

**131 MIRAFIORI**











**1974 - 2001**



**Kit Parçaları**

Resim	Ürün Kodu / Adı	OEM	OEM	Ürün Kodu / Adı	Resim
	<b>FI2006</b> Rotbaşı Sol Ve Sağ Rb5321	116002404100, 116002404101 4322905, 4322906 60521320, 60521321	4322913, SE022162449A	<b>FI3001</b> Rotmili Manuel Str 284 Mm 275 Rb5814	
	<b>FI5611</b> Salıncak Ön Alt Sol Ve Sağ Döküm Rb5611	4331252, 4468519 4469175, 7704616 7704616T			

**131 MIRAFIORI**
**1974 - 2001**

Resim	Ürün Kodu ve Açıklaması	Detay	OEM
	<b>FI15611</b> SALINCAK ÖN ALT SOL VE SAĞ DÖKÜM RB5611	Malzeme Türü : Dövme Çelik	4331252, 4468519 4469175, 7704616 7704616T
	<b>FI11009</b> SALINCAK VE DENGE KOLU BURCU ÖN ALT SOL VE SAĞ B25159	Şasi (Ön / Arka) : ÖN Yön : Alt Sol Ve Sağ Ağırlık : 0,194 kg / 0.428 lb	4331968
	<b>FI12041</b> VİRAJ DEMİR LASTİĞİ SOL VE SAĞ	Yön : Sol Ve Sağ Ağırlık : 0.97 kg / 2.138 lb	1307628080, 7544738
	<b>FI12067</b> AMORTİSÖR TAKOZU SOL VE SAĞ AMORTİSÖR TAKOZU ÖN	Yön : Sol Ve Sağ Ağırlık : 0.65 kg / 1.433 lb Not : AMORTİSÖR TAKOZU ÖN	85006635
	<b>FI12069</b> AMORTİSÖR TAKOZU SOL VE SAĞ AMORTİSÖR TAKOZU ÖN	Yön : Sol Ve Sağ Ağırlık : 0.69 kg / 1.521 lb Not : AMORTİSÖR TAKOZU ÖN	5933818
	<b>FI12007</b> MOTOR TAKOZU SOL VE SAĞ MOTOR TAKOZU (KF1006)	Yön : Sol Ve Sağ Ağırlık : 0.47 kg / 1.036 lb Not : Motor takozu	, 85008575
	<b>FI12012</b> MOTOR TAKOZU SOL VE SAĞ MOTOR TAKOZU (KF1007)	Yön : Sol Ve Sağ Ağırlık : 0.622 kg / 1.371 lb Not : Motor takozu	4459824, 7732923
	<b>FI12170</b> MOTOR TAKOZU SOL VE SAĞ MOTOR TAKOZU ÖN	Yön : Sol Ve Sağ Ağırlık : 0.344 kg / 0.758 lb Not : MOTOR TAKOZU ÖN	21011001020, 4066936 4145981
	<b>FI12073</b> ŞANZİMAN TAKOZU SOL VE SAĞ ŞANZİMAN TAKOZU	Yön : Sol Ve Sağ Ağırlık : 0.52 kg / 1.146 lb Not : ŞANZİMAN TAKOZU	4331727
	<b>FI12074</b> ŞANZİMAN TAKOZU SOL VE SAĞ ŞANZİMAN TAKOZU	Yön : Sol Ve Sağ Ağırlık : 0.479 kg / 1.056 lb Not : ŞANZİMAN TAKOZU	4331723
	<b>FI12075</b> ŞANZİMAN TAKOZU SOL VE SAĞ ŞANZİMAN TAKOZU	Yön : Sol Ve Sağ Ağırlık : 0.46 kg / 1.014 lb Not : ŞANZİMAN TAKOZU	85013257

\* Bu sayfada ve katalogdaki tüm araçların adları, markaları, modelleri, sembolleri, logoları, orjinal numaraları (oe) ve diğer üçüncü parti numaraları sadece referans amaçlı kullanılmaktadır.



**131 MIRAFIORI**
**1974 - 2001**

Resim	Ürün Kodu ve Açıklaması	Detay	OEM
	<b>FI12006</b> ŞAFT TAKOZU SOL VE SAĞ ŞART ARA YATAK RULMANSIZ (KF1005)	Yön : Sol Ve Sağ Ağırlık : 0.576 kg / 1.270 lb Not : ŞART ARA YATAK RULMANSIZ	4181556, 4188676
	<b>FI12006K</b> ŞAFT TAKOZU SOL VE SAĞ ŞAFT ARA YATAK RULMANLI	Yön : Sol Ve Sağ Ağırlık : 0.64 kg / 1.411 lb Not : ŞAFT ARA YATAK RULMANLI	4181556
	<b>FI12010</b> ŞAFT TAKOZU SOL VE SAĞ ŞAFT KAPLİNİ 6 KÖŞE (KF1034)	Yön : Sol Ve Sağ Ağırlık : 0.758 kg / 1.671 lb Not : Şaft Kaplini 6 köşe	138705, 21012202120 2101300095, 4516081 4516801
	<b>FI12172</b> SÜSPANSİYON TAKOZU SOL VE SAĞ SÜSPANSİYON TAKOZU ÖN	Yön : Sol Ve Sağ Ağırlık : 0.244 kg / 0.538 lb Not : SÜSPANSİYON TAKOZU ÖN	4412992
	<b>FI12171</b> RADYATÖR TAKOZU SOL VE SAĞ RADYATÖR ALT LASTİĞİ	Yön : Sol Ve Sağ Ağırlık : 0.1 kg / 0.220 lb Not : RADYATÖR ALT LASTİĞİ	4289142
	<b>FI13004</b> RIW DİREKSİYON KÖRÜĞÜ ( K21054 ) SAĞ .	Ağırlık : 0.15 kg / 0.331 lb	4373922
	<b>FI13005</b> RIW DİREKSİYON KÖRÜĞÜ ( K21057 ) SOL .	Ağırlık : 0.082 kg / 0.181 lb	4373921
	<b>FI13006</b> DİREKSİYON KÖRÜĞÜ SAĞ	Ağırlık : 0.129 kg / 0.284 lb	36020028
	<b>FI13007</b> DİREKSİYON KÖRÜĞÜ SOL	Ağırlık : 0.129 kg / 0.284 lb	36020027

**FI8011 / Süspansiyon Kit Ön**



**131 MIRAFIORI**

**SLX**











**1974 - 2001**



**Kit Parçaları**





Resim	Ürün Kodu / Adı	OEM	OEM	Ürün Kodu / Adı	Resim
	<b>FI2006</b> Rotbaşı Sol Ve Sağ Rb5321	116002404100, 116002404101 4322905, 4322906 60521320, 60521321	15000099, 9939038 9940260	<b>FI3003</b> Rotmili Slx Sağ--sol Hidrolik 275 Rb5822	
	<b>FI5611</b> Salıncak Ön Alt Sol Ve Sağ Döküm Rb5611	4331252, 4468519 4469175, 7704616 7704616T			

**ALHAMBRA**
**7M**
**1996 - 2010**





Resim	Ürün Kodu ve Açıklaması	Detay	OEM
	<b>VW1025</b> ROTİL SAĞ-SOL ÜST RB6527	Ağırlık : 0,515 kg / 1.135 lb Konik Ölçüsü : Ø18,4 Bağlantı Delik Çapı : Ø11 Aşık Dış Çapı : M14X1,5	, 1111156 7200946, 7M0407365A 7M3407365A, 95VW3395AA YM213395BA
	<b>VW2018</b> ROTBAŞI SAĞ RB6337	Ağırlık : 0,815 kg / 1.797 lb Uzunluk : 220 mm / 8.66 inch Gövde Dış Çapı : M14X1,5 Aşık Dış Çapı : M12X1,5 Aşık Konik Çapı : Ø14,4	, 1058378 1092377, 1092378 1234258, 7M0422818 7M0422818A, 7M0422818B 7M3422818
	<b>VW2019</b> ROTBAŞI SOL RB6336	Ağırlık : 1,056 kg / 2.328 lb Uzunluk : 220 mm / 8.66 inch Gövde Dış Çapı : M14X1,5 Aşık Dış Çapı : M12X1,5 Aşık Konik Çapı : Ø14,4	1058380, 1092380 1234259, 3M213281AA 7M0422817, 7M0422817A 7M0422817B, 7M3422817 95VW3281BB, 95VW3281BC
	<b>VW3014</b> ROTMİLİ SAĞ-SOL RB6834	Ağırlık : 0,418 kg / 0.922 lb Uzunluk : 183 mm / 7.20 inch Gövde Dış Çapı : M14X1,5 Aşık Dış Çapı : M14X1,5	1001398, 1121509 7M0422821F, 7M3422803 7M3422804, 7M3422821 7M3422821F, 95VW3281AG 95VW3281AH
	<b>VW20183014</b> ROT TAKIMI ÖN AKS SAĞ RB688135	Ağırlık : 1,25 kg / 2.756 lb Rotbaşı : VW2018 Rotmili : VW3014	1001395, 1001396 1020496, 1092376 1121508, 1233553 7200944, 7398676 7M0422804F, 7M0422804G
	<b>VW20193014</b> ROT TAKIMI ÖN AKS SOL RB688136	Ağırlık : 1,24 kg / 2.734 lb Rotbaşı : VW2019 Rotmili : VW3014	1001397, 1001398 1020497, 109232 1092382, 1121509 1233552, 7M0422803F 7M0422803G, 7M3422803
	<b>VW4021</b> Z ROT ÖN SAĞ-SOL RB6914	Ağırlık : 0,35 kg / 0.772 lb Malzeme Türü : Metal Uzunluk : 205 mm / 8.07 inch Aşık Dış Çapı : M12X1,5	1009591, 1141774 1232756, 1353188 1361653, 1M0411317D 1M215489AB, 7200959 7M0411317C, 7M0411317D
	<b>VW6021</b> SALINCAK ÖN SAĞ RB7059	Ağırlık : 4,291 kg / 9.460 lb Malzeme Türü : Dövme Çelik	1012632, 7M0407152B 95VW3078AC
	<b>VW6022</b> SALINCAK ÖN SOL RB7058	Ağırlık : 4,323 kg / 9.531 lb Malzeme Türü : Dövme Çelik	1007602, 7M0407151B 95VW3079AC
	<b>VW11057</b> SALINCAK VE DENGE KOLU BURCU SOL VE SAĞ B26117	Yön : Sol Ve Sağ Ağırlık : 0,11 kg / 0.243 lb	701407183, 7201717 7M0501541
	<b>VW11058</b> SALINCAK VE DENGE KOLU BURCU ÖN SOL VE SAĞ B26118	Şasi (Ön / Arka) : ÖN Yön : Sol Ve Sağ Ağırlık : 0,179 kg / 0.395 lb	1044571, 7396830 7M0407181, 7M0407181A 95VW3A252BA, 95VW5A638CA

\* Bu sayfada ve katalogdaki tüm araçların adları, markaları, modelleri, sembolleri, logoları, orjinal numaraları (oe) ve diğer üçüncü parti numaraları sadece referans amaçlı kullanılmaktadır.

**ALHAMBRA**
**7M**
**1996 - 2010**

Resim	Ürün Kodu ve Açıklaması	Detay	OEM
	<b>FO12070</b> BEŞİK (TRAVERS) BURCU ARKA SOL VE SAĞ	Şasi (Ön / Arka) : ARKA Yön : Sol Ve Sağ Ağırlık : 0,530 kg / 1.168 lb	7201723, 7M0505222B 95VW5K817DB
	<b>VW12006</b> AMORTİSÖR TAKOZU SOL VE SAĞ AMORTİSÖR ÜST TAKOZU	Yön : Sol Ve Sağ Ağırlık : 0.445 kg / 0.981 lb Not : AMORTİSÖR ÜST TAKOZU	357412331A, 7201848 7M0412331, 95VW3K031AA
	<b>RN14017</b> AKS KÖRÜĞÜ +KELEPÇE+YAĞ. DIŞ	Ağırlık : 0.28 kg / 0.617 lb	1075638, 1109786 272440, 272483 3301685, 701498203A 7701470155, 7M0407285A 7M0498203, 8994154
	<b>VW14011</b> AKS KÖRÜĞÜ +KELEPÇE+YAĞ. İÇ	Ağırlık : 0.236 kg / 0.520 lb	1K0498201D

**ALHAMBRA**
**7N**
**2010 - 2022**

Resim	Ürün Kodu ve Açıklaması	Detay	OEM
	<b>VW1019</b> ROTİL ÖN SAĞ Ø15,3 RB2538	Ağırlık : 0,555 kg / 1.224 lb Konik Ölçüsü : Ø15,3 Bağlantı Delik Çapı : Ø10,5 Aşık Diş Çapı : M12X1,5	3C0407366A
	<b>VW1020</b> ROTİL ÖN SOL Ø15,3 RB2539	Ağırlık : 0,555 kg / 1.224 lb Konik Ölçüsü : Ø15,3 Bağlantı Delik Çapı : Ø10,5 Aşık Diş Çapı : M12X1,5	3C0407365A
	<b>VW2008</b> ROTBAŞI ÖN SAĞ RD0342	Ağırlık : 0,412 kg / 0.908 lb Uzunluk : 95 mm / 3.74 inch Gövde Diş Çapı : M16X1,5 Aşık Diş Çapı : M12X1,5 Aşık Konik Çapı : Ø12,7	1K0423812A, 1K0423812C 1K0423812E, 1K0423812G 1K0423812J, 1K0423812K 1KD423812A
	<b>VW2009</b> ROTBAŞI ÖN SOL RD0343	Ağırlık : 0,412 kg / 0.908 lb Uzunluk : 95 mm / 3.74 inch Gövde Diş Çapı : M16X1,5 Aşık Diş Çapı : M12X1,5 Aşık Konik Çapı : Ø13,5	1K0423811A, 1K0423811C 1K0423811E, 1K0423811G 1K0423811J, 1K0423811K 1KD423811A
	<b>VW3009</b> ROTMİLİ SAĞ-SOL 310 RB2838	Ağırlık : 0,665 kg / 1.466 lb Uzunluk : 311 mm / 12.24 inch Gövde Diş Çapı : M16X1,5 Aşık Diş Çapı : M16X1,5	1K0423810A

**VW8002 / Süspansiyon Kit Ön**
**ALHAMBRA**
**7N**
**2010 - 2022**

**Kit Parçaları**











Resim	Ürün Kodu / Adı	OEM	OEM	Ürün Kodu / Adı	Resim
	<b>VW2008</b> Rotbaşı Ön Sağ Rd0342	1K0423812A, 1K0423812C 1K0423812E, 1K0423812G 1K0423812J, 1K0423812K 1KD423812A	1K0423811A, 1K0423811C 1K0423811E, 1K0423811G 1K0423811J, 1K0423811K 1KD423811A	<b>VW2009</b> Rotbaşı Ön Sol Rd0343	
	<b>VW3009</b> Rotmili Sağ-sol 310 Rb2838	1K0423810A	1K0411315B, 1K0411315D 1K0411315J, 1K0411315K 1K0411315R, 5Q0411315A 5Q0411315B	<b>VW4014</b> Z Rot Ön Sağ-sol Metal 335 Rb2935	
	<b>VW6032</b> Salıncak Ön Sağ Rd1051	3C0407151A, 3C0407151B 3C0407151E, 3C0407151G*	3C0407151A, 3C0407151B 3C0407151E, 3C0407151H*	<b>VW6033</b> Salıncak Ön Sol Rd1052	

**ALHAMBRA**
**7N**
**2010 - 2022**

Resim	Ürün Kodu ve Açıklaması	Detay	OEM
	<b>SK4005</b> Z ROT ÖM SAĞ-SOL L=335MM	Ağırlık : 0,322 kg / 0.710 lb Malzeme Türü : Metal Uzunluk : 335 mm / 13.19 inch Aşık Diş Çapı : M12X1,5	5Q0411315B
	<b>VW4014</b> Z ROT ÖN SAĞ-SOL METAL 335 RB2935	Ağırlık : 0,46 kg / 1.014 lb Malzeme Türü : Metal Uzunluk : 335 mm / 13.19 inch Aşık Diş Çapı : M12X1,5	1K0411315B, 1K0411315D 1K0411315J, 1K0411315K 1K0411315R, 5Q0411315A 5Q0411315B
	<b>VW6032</b> SALINCAK ÖN SAĞ RD1051	Ağırlık : 3,441 kg / 7.586 lb Malzeme Türü : Alüminyum	3C0407151A, 3C0407151B 3C0407151E, 3C0407151G*
	<b>VW6032J</b> SALINCAK ÖN RD1050	Ağırlık : 2,9 kg / 6.393 lb Malzeme Türü : Alüminyum	3C0407151A, 3C0407151B 3C0407151E, 3C0407151G 3C0407151H
	<b>VW6033</b> SALINCAK ÖN SOL RD1052	Ağırlık : 3,441 kg / 7.586 lb Malzeme Türü : Alüminyum	3C0407151A, 3C0407151B 3C0407151E, 3C0407151H*
	<b>VW6059</b> SALINCAK ÖN ALT SAĞ	Ağırlık : 3,490 kg / 7.694 lb Malzeme Türü : Alüminyum	3C0407152A, 3C0407152B 3C0407152E
	<b>VW6060</b> SALINCAK ALT SOL	Ağırlık : 3,490 kg / 7.694 lb Malzeme Türü : Alüminyum	3C0407151A, 3C0407151B 3C0407151E
	<b>VW11037</b> SALINCAK VE DENGE KOLU BURCU SOL VE SAĞ	Yön : Sol Ve Sağ Ağırlık : 0.11 kg / 0.243 lb	1K0505279A
	<b>VW11042</b> SALINCAK VE DENGE KOLU BURCU ORTA SOL VE SAĞ	Yön : Orta Sol Ve Sağ Ağırlık : 0,182 kg / 0.401 lb	1K0407182, 5Q0407182
	<b>VW11046</b> SALINCAK VE DENGE KOLU BURCU SAĞ B40133	Yön : Sağ Ağırlık : 0,6 kg / 1.323 lb	3C0199231A, 3C0199231B 3C0199231D
	<b>VW11046B</b> SALINCAK VE DENGE KOLU BURCU SAĞ	Yön : Sağ Ağırlık : 0.445 kg / 0.981 lb Not : BURÇ GÖVDESİ	3C0199231A, 3C0199231B 3C0199231D

\* Bu sayfada ve katalogdaki tüm araçların adları, markaları, modelleri, sembolleri, logoları, orjinal numaraları (oe) ve diğer üçüncü parti numaraları sadece referans amaçlı kullanılmaktadır.

**ALHAMBRA**
**7N**
**2010 - 2022**









Resim	Ürün Kodu ve Açıklaması	Detay	OEM
	<b>VW11051</b> SALINCAK VE DENGE KOLU BURCU SOL VE SAĞ	Yön : Sol Ve Sağ Ağırlık : 0.121 kg / 0.267 lb	6Q0407183, 6Q0407183A
	<b>VW12159</b> TAŞIYICI DESTEK BURÇLARI ARKA SOL VE SAĞ	Şasi (Ön / Arka) : ARKA Yön : Sol Ve Sağ Ağırlık : 0,130 kg / 0.287 lb	1K0505553, 1K0505553A
	<b>AU12024</b> TORSİYON BURCU ARKA SOL VE SAĞ	Şasi (Ön / Arka) : ARKA Yön : Sol Ve Sağ Ağırlık : 0.557 kg / 1.228 lb	1K0505145F, 1K0505145H 1K0505145K
	<b>VW12137</b> VİRAJ DEMİR LASTİĞİ	Şasi (Ön / Arka) : ARKA Ağırlık : 0,070 kg / 0.154 lb Not : Ø17mm	1K0511327AQ
	<b>VW12137K</b> VİRAJ DEMİR LASTİĞİ	Şasi (Ön / Arka) : ARKA Ağırlık : 0,140 kg / 0.309 lb Not : KIT	1K0511327AQ
	<b>AU12021</b> MOTOR TAKOZU SOL VE SAĞ MOTOR TAKOZU	Yön : Sol Ve Sağ Ağırlık : 0.6 kg / 1.323 lb Malzeme Türü : Motor Takozu	5N0199855B, 5N0199855C 5N0199855E
	<b>VW12097</b> MOTOR TAKOZU SOL VE SAĞ MOTOR TAKOZU	Yön : Sol Ve Sağ Ağırlık : 0.251 kg / 0.553 lb Not : MOTOR TAKOZU	1K0199868, 1K0199868A 1K0199868C, 1K0199868P 1K0199868Q
	<b>VW12134</b> MOTOR TAKOZU ÖN SOL	Şasi (Ön / Arka) : ÖN Yön : Sol Ağırlık : 2,145 kg / 4.729 lb	5N0199262D, 5N0199262M 5N0199262N
	<b>VW12051</b> SÜSPANSİYON TAKOZU SOL VE SAĞ LASTİK DAYANAK SÜSPANSİYON	Yön : Sol Ve Sağ Ağırlık : 0.045 kg / 0.099 lb Not : LASTİK DAYANAK SÜSPANSİYON	1K0412303B
	<b>VW12086</b> RADYATÖR TAKOZU SOL VE SAĞ RADYATÖR ÜST LASTİĞİ	Yön : Sol Ve Sağ Ağırlık : 0.024 kg / 0.053 lb Not : RADYATÖR ÜST LASTİĞİ	1K0121367F
	<b>VW13006</b> DİREKSİYON KÖRÜĞÜ	Ağırlık : 0.145 kg / 0.320 lb	1K0423831A, 5C0423831

\* Bu sayfada ve katalogdaki tüm araçların adları, markaları, modelleri, sembolleri, logoları, orijinal numaraları (oe) ve diğer üçüncü parti numaraları sadece referans amaçlı kullanılmaktadır.

**ALHAMBRA**
**7N**
**2010 - 2022**

Resim	Ürün Kodu ve Açıklaması	Detay	OEM
	<b>VW13006K</b> DİREKSİYON KÖRÜĞÜ SOL VE SAĞ 2 PİECES	Ağırlık : 0.29 kg / 0.639 lb	1K0423831A, 5C0423831
	<b>AU15001</b> AMORTİSÖR KÖRÜĞÜ ÖN	Şasi (Ön / Arka) : ÖN Ağırlık : 0,110 kg / 0.243 lb	6N0413175A

**ALTEA**
**V 5P1**
**2004 - 2009**

Resim	Ürün Kodu ve Açıklaması	Detay	OEM
	<b>VW1014</b> ROTİL ÖN ALT SAĞ Ø15,6 RB2536	Ağırlık : 0,565 kg / 1.246 lb Konik Ölçüsü : Ø15,6 Bağlantı Delik Çapı : Ø10,5 Aşık Diş Çapı : M12X1,5	1K0407366B, 1K0407366C 1K0407366E, 5Q0407366A
	<b>VW1015</b> ROTİL ÖN ALT SOL Ø15,6 RB2537	Ağırlık : 0,565 kg / 1.246 lb Konik Ölçüsü : Ø15,6 Bağlantı Delik Çapı : Ø10,5 Aşık Diş Çapı : M12X1,5	1K0407365B, 1K0407365C 1K0407365E, 5Q0407365A
	<b>VW2008</b> ROTBAŞI ÖN SAĞ RD0342	Ağırlık : 0,412 kg / 0.908 lb Uzunluk : 95 mm / 3.74 inch Gövde Diş Çapı : M16X1,5 Aşık Diş Çapı : M12X1,5 Aşık Konik Çapı : Ø12,7	1K0423812A, 1K0423812C 1K0423812E, 1K0423812G 1K0423812J, 1K0423812K 1KD423812A
	<b>VW2009</b> ROTBAŞI ÖN SOL RD0343	Ağırlık : 0,412 kg / 0.908 lb Uzunluk : 95 mm / 3.74 inch Gövde Diş Çapı : M16X1,5 Aşık Diş Çapı : M12X1,5 Aşık Konik Çapı : Ø13,5	1K0423811A, 1K0423811C 1K0423811E, 1K0423811G 1K0423811J, 1K0423811K 1KD423811A
	<b>VW3009</b> ROTMİLİ SAĞ-SOL 310 RB2838	Ağırlık : 0,665 kg / 1.466 lb Uzunluk : 311 mm / 12.24 inch Gövde Diş Çapı : M16X1,5 Aşık Diş Çapı : M16X1,5	1K0423810A
	<b>VW20083009</b> ROT TAKIMI ÖN AKS SAĞ RB288137	Ağırlık : 1,078 kg / 2.377 lb Rotbaşı : VW2008 Rotmili : VW3009	
	<b>VW20093009</b> ROT TAKIMI ÖN SOL RB288138	Ağırlık : 1,077 kg / 2.374 lb Rotbaşı : VW2009 Rotmili : VW3009	
	<b>SK4005</b> Z ROT ÖM SAĞ-SOL L=335MM	Ağırlık : 0,322 kg / 0.710 lb Malzeme Türü : Metal Uzunluk : 335 mm / 13.19 inch Aşık Diş Çapı : M12X1,5	5Q0411315B

\* Bu sayfada ve katalogdaki tüm araçların adları, markaları, modelleri, sembolleri, logoları, orijinal numaraları (oe) ve diğer üçüncü parti numaraları sadece referans amaçlı kullanılmaktadır.













**ALTEA**
**V 5P1**
**2004 - 2009**

Resim	Ürün Kodu ve Açıklaması	Detay	OEM
	<b>VW4014</b> Z ROT ÖN SAĞ-SOL METAL 335 RB2935	Ağırlık : 0,46 kg / 1.014 lb Malzeme Türü : Metal Uzunluk : 335 mm / 13.19 inch Aşık Diş Çapı : M12X1,5	1K0411315B, 1K0411315D 1K0411315J, 1K0411315K 1K0411315R, 5Q0411315A 5Q0411315B
	<b>VW4015</b> Z ROT SOL VE SAĞ METAL RB2937	Ağırlık : 0,373 kg / 0.822 lb Malzeme Türü : Metal Uzunluk : 95,5 mm / 3.76 inch Aşık Diş Çapı : M10X1,5	1K0505465C, 1K0505465D 1K0505465H, 1K0505465J 1K0505465K
	<b>VW4015K</b> Z ROT SOL VE SAĞ METAL	Ağırlık : 0,373 kg / 0.822 lb Malzeme Türü : Metal Uzunluk : 95,5 mm / 3.76 inch Aşık Diş Çapı : M10X1,5	1K0505465C, 1K0505465D 1K0505465H, 1K0505465J 1K0505465K
	<b>AU6010</b> SALINCAK ÜST SOL VE SAĞ RA5155	Ağırlık : 1,298 kg / 2.862 lb Malzeme Türü : Sac Metal	1K0505323H, 1K0505323N
	<b>VW6016</b> SALINCAK ÖN SAĞ RD10227	Ağırlık : 4,543 kg / 10.016 lb Malzeme Türü : Sac Metal	1K0407152P, 1K0407152Q* 1K0407152Q
	<b>VW6016J</b> SALINCAK ÖN ALT SAĞ S737	Ağırlık : 4,015 kg / 8.852 lb Malzeme Türü : Sac Metal	1K0407151P, 1K0407151Q 1K0407152P, 1K0407152Q
	<b>VW6017</b> SALINCAK ÖN SOL RD10226	Ağırlık : 4,543 kg / 10.016 lb Malzeme Türü : Sac Metal	1K0407151M*, 1K0407151P 1K0407151Q*, 1K0407151Q
	<b>VW6017J</b> SALINCAK ÖN ALT SOL S738	Ağırlık : 4,015 kg / 8.852 lb Malzeme Türü : Sac Metal	1K0407151P, 1K0407151Q 1K0407152P, 1K0407152Q
	<b>VW6018</b> SALINCAK ÖN SAĞ RB30219	Ağırlık : 4,85 kg / 10.692 lb Malzeme Türü : Döküm Çelik	1K0407152AC*, 1K0407152M* 1K0407152P, 1K0407152Q 1K0407152R*
	<b>VW6018J</b> SALINCAK ÖN SAĞ RB30211	Ağırlık : 4,232 kg / 9.330 lb Malzeme Türü : Döküm Çelik	1K0407152AC, 1K0407152M 1K0407152R
	<b>VW6019</b> SALINCAK ÖN SOL RB30218	Ağırlık : 4,85 kg / 10.692 lb Malzeme Türü : Döküm Çelik	1K0407151AC*, 1K0407151AC 1K0407151M*, 1K0407151M 1K0407151R*, 1K0407151R





\* Bu sayfada ve katalogdaki tüm araçların adları, markaları, modelleri, sembolleri, logoları, orjinal numaraları (oe) ve diğer üçüncü parti numaraları sadece referans amaçlı kullanılmaktadır.

**ALTEA**
**V 5P1**
**2004 - 2009**

Resim	Ürün Kodu ve Açıklaması	Detay	OEM
	<b>VW6019J</b> SALINCAK ÖN SOL RB30212	Ağırlık : 4,232 kg / 9.330 lb Malzeme Türü : Döküm Çelik	1K0407151AC, 1K0407151M 1K0407151R
	<b>VW9001</b> SALINCAK ARKA	Ağırlık : 2,55 kg / 5.622 lb Malzeme Türü : Sac Metal	1K0505311AA, 1K0505311ABÂ 1K0505311H, 1K0505311S 1K0505311T
	<b>AU11014</b> SALINCAK VE DENGE KOLU BURCU ARKA SOL VE SAĞ	Şasi (Ön / Arka) : ARKA Yön : Sol Ve Sağ Ağırlık : 0.192 kg / 0.423 lb	1K0505543A
	<b>AU11035</b> SALINCAK VE DENGE KOLU BURCU ARKA SOL VE SAĞ	Şasi (Ön / Arka) : ARKA Yön : Sol Ve Sağ Ağırlık : 0,25 kg / 0.551 lb	1K0505171C
	<b>VW11037</b> SALINCAK VE DENGE KOLU BURCU SOL VE SAĞ	Yön : Sol Ve Sağ Ağırlık : 0.11 kg / 0.243 lb	1K0505279A
	<b>VW11042</b> SALINCAK VE DENGE KOLU BURCU ORTA SOL VE SAĞ	Yön : Orta Sol Ve Sağ Ağırlık : 0,182 kg / 0.401 lb	1K0407182, 5Q0407182
	<b>VW11043</b> SALINCAK VE DENGE KOLU BURCU SAĞ B22141	Yön : Sağ Diğer Taraf : VW11044 Ağırlık : 0,659 kg / 1.453 lb	1K0199232G, 1K0199232H 1K0199232J
	<b>VW11043B</b> SALINCAK VE DENGE KOLU BURCU SAĞ	Yön : Sağ Diğer Taraf : VW11044B Ağırlık : 0,659 kg / 1.453 lb Not : İÇ BURÇSUZ	1K0199232G, 1K0199232H 1K0199232J
	<b>VW11044</b> SALINCAK VE DENGE KOLU BURCU SOL B22142	Yön : Sol Diğer Taraf : VW11043 Ağırlık : 0,678 kg / 1.495 lb	1K0199231G, 1K0199231H 1K0199231J
	<b>VW11044B</b> SALINCAK VE DENGE KOLU BURCU SOL	Yön : Sol Diğer Taraf : VW11043B Ağırlık : 0,678 kg / 1.495 lb Not : İÇ BURÇSUZ	1K0199231G, 1K0199231H 1K0199231J
	<b>VW11047</b> SALINCAK VE DENGE KOLU BURCU İÇ SOL VE SAĞ B37117	Yön : İç Sol Ve Sağ Ağırlık : 0,121 kg / 0.267 lb	1K0199231J, 1K0199231J-P 1K0407183E











\* Bu sayfada ve katalogdaki tüm araçların adları, markaları, modelleri, sembolleri, logoları, orjinal numaraları (oe) ve diğer üçüncü parti numaraları sadece referans amaçlı kullanılmaktadır.

**ALTEA**
**V 5P1**
**2004 - 2009**

Resim	Ürün Kodu ve Açıklaması	Detay	OEM
	<b>VW11051</b> SALINCAK VE DENGİ KOLU BURCU SOL VE SAĞ	Yön : Sol Ve Sağ Ağırlık : 0.121 kg / 0.267 lb	6Q0407183, 6Q0407183A
	<b>VW11055</b> SALINCAK VE DENGİ KOLU BURCU İÇ SOL VE SAĞ	Yön : İç Sol Ve Sağ Ağırlık : 0.121 kg / 0.267 lb	1K0407183E, 8J0407183
	<b>VW11056</b> SALINCAK VE DENGİ KOLU BURCU ARKA SOL VE SAĞ	Şasi (Ön / Arka) : ARKA Yön : Sol Ve Sağ Ağırlık : 0.13 kg / 0.287 lb	1K0505203A, 1K0505323D 1K0505323G, 1K0505323H 1K0505323N, 5Q0505323C
	<b>VW11180</b> Z-ROT BURCU ARKA	Şasi (Ön / Arka) : ARKA Ağırlık : 0.069 kg / 0.152 lb Uzunluk : VW4015 mm / 0.00 inch Aşık Diş Çapı : VW4015K	1K0505465C*, 1K0505465D* 1K0505465H*, 1K0505465J* 1K0505465K*
	<b>VW12159</b> TAŞIYICI DESTEK BURÇLARI ARKA SOL VE SAĞ	Şasi (Ön / Arka) : ARKA Yön : Sol Ve Sağ Ağırlık : 0,130 kg / 0.287 lb	1K0505553, 1K0505553A
	<b>SK12003</b> VİRAJ DEMİR LASTİĞİ SOL VE SAĞ RUBBER	Şasi (Ön / Arka) : ÖN Yön : Sol Ve Sağ Ağırlık : 0,075 kg / 0.165 lb Malzeme Türü : Rubber	1K0411303, 1K0411303AL* 1K0411303BK, 1K0411314 3C0411303AA*, 3C0411303T*
	<b>SK12003K</b> VİRAJ DEMİR LASTİĞİ SOL VE SAĞ RUBBER	Şasi (Ön / Arka) : ÖN Yön : Sol Ve Sağ Ağırlık : 0,150 kg / 0.331 lb Malzeme Türü : Rubber	1K0411303, 1K0411303AL* 1K0411303BK, 1K0411314 3C0411303AA*, 3C0411303T*
	<b>VW12017</b> AMORTİSÖR TAKOZU SOL VE SAĞ AMORTİSÖR TAKOZU	Yön : Sol Ve Sağ Ağırlık : 0.847 kg / 1.867 lb Not : AMORTİSÖR TAKOZU	1K0412331B, 1K0412331C
	<b>VW12109</b> AMORTİSÖR TAKOZU SOL VE SAĞ AMORTİSÖR RULMANI	Yön : Sol Ve Sağ Ağırlık : 0.26 kg / 0.573 lb Not : AMORTİSÖR RULMANI	6N0412249C, 6N0412249E
	<b>VW12109K</b> AMORTİSÖR TAKOZU SOL VE SAĞ 2 PCS	Yön : Sol Ve Sağ Ağırlık : 0.52 kg / 1.146 lb Not : 2 PCS	6N0412249C, 6N0412249E
	<b>VW12025</b> MOTOR TAKOZU ALT SOL VE SAĞ MOTOR TAKOZU ALT	Yön : Alt Sol Ve Sağ Ağırlık : 0.25 kg / 0.551 lb Not : MOTOR TAKOZU ALT	1K0199867A, 1K0199867B 1K0199867Q

\* Bu sayfada ve katalogdaki tüm araçların adları, markaları, modelleri, sembolleri, logoları, orijinal numaraları (oe) ve diğer üçüncü parti numaraları sadece referans amaçlı kullanılmaktadır.

**ALTEA**
**V 5P1**
**2004 - 2009**

Resim	Ürün Kodu ve Açıklaması	Detay	OEM
	<b>VW12027</b> MOTOR TAKOZU SOL VE SAĞ MOTOR KULAĞI	Yön : Sol Ve Sağ Ağırlık : 2.02 kg / 4.453 lb Not : MOTOR KULAĞI	1K0199262, 1K0199262CN
	<b>VW12029</b> MOTOR TAKOZU SOL VE SAĞ MOTOR TAKOZU	Yön : Sol Ve Sağ Ağırlık : 0.585 kg / 1.290 lb Not : Motor takozu	1K0199855AD, 1K0199855BA 1K0199855K
	<b>VW12032</b> MOTOR TAKOZU SOL VE SAĞ MOTOR TAKOZU	Yön : Sol Ve Sağ Ağırlık : 0.64 kg / 1.411 lb Not : Motor takozu	1K0199855BB, 1K0199855L
	<b>VW12034</b> MOTOR TAKOZU SOL VE SAĞ MOTOR TAKOZU	Yön : Sol Ve Sağ Ağırlık : 1.9 kg / 4.189 lb Not : Motor takozu	1K0199555BA, 1K0199555BB 1K0199555L, 1K0199555M 1L0199555L
	<b>VW12073</b> MOTOR TAKOZU SOL VE SAĞ MOTOR TAKOZU	Yön : Sol Ve Sağ Ağırlık : 1.643 kg / 3.622 lb Not : MOTOR TAKOZU	1K0199262AC, 1K0199262AL 1K0199262L
	<b>VW12076</b> MOTOR TAKOZU SOL VE SAĞ MOTOR TAKOZU	Yön : Sol Ve Sağ Ağırlık : 1.97 kg / 4.343 lb Not : MOTOR TAKOZU	1K0199262AF, 1K0199262AT 1K0199262BB
	<b>VW12077</b> MOTOR TAKOZU SOL VE SAĞ MOTOR TAKOZU	Yön : Sol Ve Sağ Ağırlık : 1.95 kg / 4.299 lb Not : MOTOR TAKOZU	1K0199262CG, 1K0199262CP
	<b>VW12082</b> MOTOR TAKOZU SOL VE SAĞ MOTOR TAKOZU	Yön : Sol Ve Sağ Ağırlık : 2.05 kg / 4.519 lb Not : MOTOR TAKOZU	1K0199262AK, 1K0199262K
	<b>VW12094</b> MOTOR TAKOZU SOL VE SAĞ MOTOR TAKOZU	Yön : Sol Ve Sağ Ağırlık : 1.872 kg / 4.127 lb Not : MOTOR TAKOZU	1K0199555N
	<b>VW12097</b> MOTOR TAKOZU SOL VE SAĞ MOTOR TAKOZU	Yön : Sol Ve Sağ Ağırlık : 0.251 kg / 0.553 lb Not : MOTOR TAKOZU	1K0199868, 1K0199868A 1K0199868C, 1K0199868P 1K0199868Q
	<b>VW12110</b> MOTOR TAKOZU SOL VE SAĞ MOTOR TAKOZU	Yön : Sol Ve Sağ Ağırlık : 1.918 kg / 4.228 lb Not : MOTOR TAKOZU	1K0199262AB, 1K0199262AM 1K0199262M

\* Bu sayfada ve katalogdaki tüm araçların adları, markaları, modelleri, sembolleri, logoları, orjinal numaraları (oe) ve diğer üçüncü parti numaraları sadece referans amaçlı kullanılmaktadır.









**ALTEA**
**V 5P1**
**2004 - 2009**

Resim	Ürün Kodu ve Açıklaması	Detay	OEM
	<b>VW12124</b> MOTOR TAKOZU SOL VE SAĞ	Yön : Sol Ve Sağ Ağırlık : 1.927 kg / 4.248 lb	1K0199262A, 1K0199262AA 1K0199262AS
	<b>VW12106</b> ŞANZIMAN TAKOZU SOL ŞANZUMAN TAKOZU SOL	Yön : Sol Ağırlık : 1.95 kg / 4.299 lb Not : ŞANZUMAN TAKOZU SOL	1K0199555AT, 1K0199555T
	<b>AU12037</b> SÜSPANSİYON TAKOZU ARKA	Şasi (Ön / Arka) : ARKA Ağırlık : 0,095 kg / 0.209 lb	1K0511353J
	<b>VW12051</b> SÜSPANSİYON TAKOZU SOL VE SAĞ LASTİK DAYANAK SUSPENSİYON	Yön : Sol Ve Sağ Ağırlık : 0.045 kg / 0.099 lb Not : LASTİK DAYANAK SUSPENSİYON	1K0412303B
	<b>VW12086</b> RADYATÖR TAKOZU SOL VE SAĞ RADYATÖR ÜST LASTİĞİ	Yön : Sol Ve Sağ Ağırlık : 0.024 kg / 0.053 lb Not : RADYATÖR ÜST LASTİĞİ	1K0121367F
	<b>VW13006</b> DİREKSİYON KÖRÜĞÜ	Ağırlık : 0.145 kg / 0.320 lb	1K0423831A, 5C0423831
	<b>VW13006K</b> DİREKSİYON KÖRÜĞÜ SOL VE SAĞ 2 PIECES	Ağırlık : 0.29 kg / 0.639 lb	1K0423831A, 5C0423831
	<b>VW14003</b> AKS KÖRÜĞÜ +KELEPÇE+YAĞ. DIŞ	Ağırlık : 0.25 kg / 0.551 lb	1K0 498 203, 1K0498203
	<b>VW14011</b> AKS KÖRÜĞÜ +KELEPÇE+YAĞ. İÇ	Ağırlık : 0.236 kg / 0.520 lb	1K0498201D
	<b>AU15001</b> AMORTİSÖR KÖRÜĞÜ ÖN	Şasi (Ön / Arka) : ÖN Ağırlık : 0,110 kg / 0.243 lb	6N0413175A

**ALTEA XL**
**5P5, 5P8**
**2006 - 2015**

Resim	Ürün Kodu ve Açıklaması	Detay	OEM
	<b>VW2008</b> ROTBAŞI ÖN SAĞ RD0342	Ağırlık : 0,412 kg / 0.908 lb Uzunluk : 95 mm / 3.74 inch Gövde Diş Çapı : M16X1,5 Aşık Diş Çapı : M12X1,5 Aşık Konik Çapı : Ø12,7	1K0423812A, 1K0423812C 1K0423812E, 1K0423812G 1K0423812J, 1K0423812K 1KD423812A
	<b>VW2009</b> ROTBAŞI ÖN SOL RD0343	Ağırlık : 0,412 kg / 0.908 lb Uzunluk : 95 mm / 3.74 inch Gövde Diş Çapı : M16X1,5 Aşık Diş Çapı : M12X1,5 Aşık Konik Çapı : Ø13,5	1K0423811A, 1K0423811C 1K0423811E, 1K0423811G 1K0423811J, 1K0423811K 1KD423811A

**ALTEA XL**
**5P5, 5P8**
**2006 - 2022**

Resim	Ürün Kodu ve Açıklaması	Detay	OEM
	<b>VW1014</b> ROTİL ÖN ALT SAĞ Ø15,6 RB2536	Ağırlık : 0,565 kg / 1.246 lb Konik Ölçüsü : Ø15,6 Bağlantı Delik Çapı : Ø10,5 Aşık Diş Çapı : M12X1,5	1K0407366B, 1K0407366C 1K0407366E, 5Q0407366A
	<b>VW1015</b> ROTİL ÖN ALT SOL Ø15,6 RB2537	Ağırlık : 0,565 kg / 1.246 lb Konik Ölçüsü : Ø15,6 Bağlantı Delik Çapı : Ø10,5 Aşık Diş Çapı : M12X1,5	1K0407365B, 1K0407365C 1K0407365E, 5Q0407365A
	<b>VW3009</b> ROTMİLİ SAĞ-SOL 310 RB2838	Ağırlık : 0,665 kg / 1.466 lb Uzunluk : 311 mm / 12.24 inch Gövde Diş Çapı : M16X1,5 Aşık Diş Çapı : M16X1,5	1K0423810A
	<b>VW20083009</b> ROT TAKIMI ÖN AKS SAĞ RB288137	Ağırlık : 1,078 kg / 2.377 lb Rotbaşı : VW2008 Rotmili : VW3009	
	<b>VW20093009</b> ROT TAKIMI ÖN SOL RB288138	Ağırlık : 1,077 kg / 2.374 lb Rotbaşı : VW2009 Rotmili : VW3009	
	<b>SK4005</b> Z ROT ÖM SAĞ-SOL L=335MM	Ağırlık : 0,322 kg / 0.710 lb Malzeme Türü : Metal Uzunluk : 335 mm / 13.19 inch Aşık Diş Çapı : M12X1,5	5Q0411315B
	<b>AU6010</b> SALINCAK ÜST SOL VE SAĞ RA5155	Ağırlık : 1,298 kg / 2.862 lb Malzeme Türü : Sac Metal	1K0505323H, 1K0505323N
	<b>SK9001</b> SALINCAK ARKA ALT	Ağırlık : 0,701 kg / 1.545 lb Malzeme Türü : Sac Metal	1K0501529J

\* Bu sayfada ve katalogdaki tüm araçların adları, markaları, modelleri, sembolleri, logoları, orjinal numaraları (oe) ve diğer üçüncü parti numaraları sadece referans amaçlı kullanılmaktadır.

**ALTEA XL**
**5P5, 5P8**
**2006 - 2022**

Resim	Ürün Kodu ve Açıklaması	Detay	OEM
	<b>VW6016</b> SALINCAK ÖN SAĞ RD10227	Ağırlık : 4,543 kg / 10.016 lb Malzeme Türü : Sac Metal	1K0407152P, 1K0407152Q* 1K0407152Q
	<b>VW6016J</b> SALINCAK ÖN ALT SAĞ S737	Ağırlık : 4,015 kg / 8.852 lb Malzeme Türü : Sac Metal	1K0407151P, 1K0407151Q 1K0407152P, 1K0407152Q
	<b>VW6017</b> SALINCAK ÖN SOL RD10226	Ağırlık : 4,543 kg / 10.016 lb Malzeme Türü : Sac Metal	1K0407151M*, 1K0407151P 1K0407151Q*, 1K0407151Q
	<b>VW6017J</b> SALINCAK ÖN ALT SOL S738	Ağırlık : 4,015 kg / 8.852 lb Malzeme Türü : Sac Metal	1K0407151P, 1K0407151Q 1K0407152P, 1K0407152Q
	<b>AU11014</b> SALINCAK VE DENGE KOLU BURCU ARKA SOL VE SAĞ	Şasi (Ön / Arka) : ARKA Yön : Sol Ve Sağ Ağırlık : 0.192 kg / 0.423 lb	1K0505543A
	<b>AU11052</b> SALINCAK VE DENGE KOLU BURCU SOL VE SAĞ	Yön : Sol Ve Sağ Ağırlık : 0,178 kg / 0.392 lb	1K0505541B, 1K0505541C 1K0505541D
	<b>SK11009</b> SALINCAK VE DENGE KOLU BURCU ARKA SOL VE SAĞ	Şasi (Ön / Arka) : ARKA Yön : Sol Ve Sağ Ağırlık : 0,176 kg / 0.388 lb	1K0501529J*
	<b>SK11010</b> SALINCAK VE DENGE KOLU BURCU ARKA SOL VE SAĞ	Şasi (Ön / Arka) : ARKA Yön : Sol Ve Sağ Ağırlık : 0,196 kg / 0.432 lb Not : BÜYÜK	1K0501529J*
	<b>VW11037</b> SALINCAK VE DENGE KOLU BURCU SOL VE SAĞ	Yön : Sol Ve Sağ Ağırlık : 0.11 kg / 0.243 lb	1K0505279A
	<b>VW11042</b> SALINCAK VE DENGE KOLU BURCU ORTA SOL VE SAĞ	Yön : Orta Sol Ve Sağ Ağırlık : 0,182 kg / 0.401 lb	1K0407182, 5Q0407182
	<b>VW11043</b> SALINCAK VE DENGE KOLU BURCU SAĞ B22141	Yön : Sağ Diğer Taraf : VW11044 Ağırlık : 0,659 kg / 1.453 lb	1K0199232G, 1K0199232H 1K0199232J

\* Bu sayfada ve katalogdaki tüm araçların adları, markaları, modelleri, sembolleri, logoları, orjinal numaraları (oe) ve diğer üçüncü parti numaraları sadece referans amaçlı kullanılmaktadır.











**ALTEA XL**
**5P5, 5P8**
**2006 - 2022**

Resim	Ürün Kodu ve Açıklaması	Detay	OEM
	<b>VW11043B</b> SALINCAK VE DENGE KOLU BURCU SAĞ	Yön : Sağ Diğer Taraf : VW11044B Ağırlık : 0,659 kg / 1.453 lb Not : İÇ BURÇSUZ	1K0199232G, 1K0199232H 1K0199232J
	<b>VW11044</b> SALINCAK VE DENGE KOLU BURCU SOL B22142	Yön : Sol Diğer Taraf : VW11043 Ağırlık : 0,678 kg / 1.495 lb	1K0199231G, 1K0199231H 1K0199231J
	<b>VW11044B</b> SALINCAK VE DENGE KOLU BURCU SOL	Yön : Sol Diğer Taraf : VW11043B Ağırlık : 0,678 kg / 1.495 lb Not : İÇ BURÇSUZ	1K0199231G, 1K0199231H 1K0199231J
	<b>VW11051</b> SALINCAK VE DENGE KOLU BURCU SOL VE SAĞ	Yön : Sol Ve Sağ Ağırlık : 0.121 kg / 0.267 lb	6Q0407183, 6Q0407183A
	<b>VW11056</b> SALINCAK VE DENGE KOLU BURCU ARKA SOL VE SAĞ	Şasi (Ön / Arka) : ARKA Yön : Sol Ve Sağ Ağırlık : 0.13 kg / 0.287 lb	1K0505203A, 1K0505323D 1K0505323G, 1K0505323H 1K0505323N, 5Q0505323C
	<b>VW12159</b> TAŞIYICI DESTEK BURÇLARI ARKA SOL VE SAĞ	Şasi (Ön / Arka) : ARKA Yön : Sol Ve Sağ Ağırlık : 0,130 kg / 0.287 lb	1K0505553, 1K0505553A
	<b>AU12024</b> TORSİYON BURCU ARKA SOL VE SAĞ	Şasi (Ön / Arka) : ARKA Yön : Sol Ve Sağ Ağırlık : 0.557 kg / 1.228 lb	1K0505145F, 1K0505145H 1K0505145K
	<b>SK12003</b> VİRAJ DEMİR LASTİĞİ SOL VE SAĞ RUBBER	Şasi (Ön / Arka) : ÖN Yön : Sol Ve Sağ Ağırlık : 0,075 kg / 0.165 lb Malzeme Türü : Rubber	1K0411303, 1K0411303AL* 1K0411303BK, 1K0411314 3C0411303AA*, 3C0411303T*
	<b>SK12003K</b> VİRAJ DEMİR LASTİĞİ SOL VE SAĞ RUBBER	Şasi (Ön / Arka) : ÖN Yön : Sol Ve Sağ Ağırlık : 0,150 kg / 0.331 lb Malzeme Türü : Rubber	1K0411303, 1K0411303AL* 1K0411303BK, 1K0411314 3C0411303AA*, 3C0411303T*
	<b>VW12017</b> AMORTİSÖR TAKOZU SOL VE SAĞ AMORTİSÖR TAKOZU	Yön : Sol Ve Sağ Ağırlık : 0.847 kg / 1.867 lb Not : AMORTİSÖR TAKOZU	1K0412331B, 1K0412331C
	<b>VW12109</b> AMORTİSÖR TAKOZU SOL VE SAĞ AMORTİSÖR RULMANI	Yön : Sol Ve Sağ Ağırlık : 0.26 kg / 0.573 lb Not : AMORTİSÖR RULMANI	6N0412249C, 6N0412249E

\* Bu sayfada ve katalogdaki tüm araçların adları, markaları, modelleri, sembolleri, logoları, orjinal numaraları (oe) ve diğer üçüncü parti numaraları sadece referans amaçlı kullanılmaktadır.



**ALTEA XL**
**5P5, 5P8**
**2006 - 2022**

Resim	Ürün Kodu ve Açıklaması	Detay	OEM
	<b>VW12109K</b> AMORTİSÖR TAKOZU SOL VE SAĞ 2 PCS	Yön : Sol Ve Sağ Ağırlık : 0.52 kg / 1.146 lb Not : 2 PCS	6N0412249C, 6N0412249E
	<b>VW12025</b> MOTOR TAKOZU ALT SOL VE SAĞ MOTOR TAKOZU ALT	Yön : Alt Sol Ve Sağ Ağırlık : 0.25 kg / 0.551 lb Not : MOTOR TAKOZU ALT	1K0199867A, 1K0199867B 1K0199867Q
	<b>VW12027</b> MOTOR TAKOZU SOL VE SAĞ MOTOR KULAĞI	Yön : Sol Ve Sağ Ağırlık : 2.02 kg / 4.453 lb Not : MOTOR KULAĞI	1K0199262, 1K0199262CN
	<b>VW12029</b> MOTOR TAKOZU SOL VE SAĞ MOTOR TAKOZU	Yön : Sol Ve Sağ Ağırlık : 0.585 kg / 1.290 lb Not : Motor takozu	1K0199855AD, 1K0199855BA 1K0199855K
	<b>VW12034</b> MOTOR TAKOZU SOL VE SAĞ MOTOR TAKOZU	Yön : Sol Ve Sağ Ağırlık : 1.9 kg / 4.189 lb Not : Motor takozu	1K0199555BA, 1K0199555BB 1K0199555L, 1K0199555M 1L0199555L
	<b>VW12073</b> MOTOR TAKOZU SOL VE SAĞ MOTOR TAKOZU	Yön : Sol Ve Sağ Ağırlık : 1.643 kg / 3.622 lb Not : MOTOR TAKOZU	1K0199262AC, 1K0199262AL 1K0199262L
	<b>VW12076</b> MOTOR TAKOZU SOL VE SAĞ MOTOR TAKOZU	Yön : Sol Ve Sağ Ağırlık : 1.97 kg / 4.343 lb Not : MOTOR TAKOZU	1K0199262AF, 1K0199262AT 1K0199262BB
	<b>VW12077</b> MOTOR TAKOZU SOL VE SAĞ MOTOR TAKOZU	Yön : Sol Ve Sağ Ağırlık : 1.95 kg / 4.299 lb Not : MOTOR TAKOZU	1K0199262CG, 1K0199262CP
	<b>VW12094</b> MOTOR TAKOZU SOL VE SAĞ MOTOR TAKOZU	Yön : Sol Ve Sağ Ağırlık : 1.872 kg / 4.127 lb Not : MOTOR TAKOZU	1K0199555N
	<b>VW12097</b> MOTOR TAKOZU SOL VE SAĞ MOTOR TAKOZU	Yön : Sol Ve Sağ Ağırlık : 0.251 kg / 0.553 lb Not : MOTOR TAKOZU	1K0199868, 1K0199868A 1K0199868C, 1K0199868P 1K0199868Q
	<b>VW12110</b> MOTOR TAKOZU SOL VE SAĞ MOTOR TAKOZU	Yön : Sol Ve Sağ Ağırlık : 1.918 kg / 4.228 lb Not : MOTOR TAKOZU	1K0199262AB, 1K0199262AM 1K0199262M

\* Bu sayfada ve katalogdaki tüm araçların adları, markaları, modelleri, sembolleri, logoları, orjinal numaraları (oe) ve diğer üçüncü parti numaraları sadece referans amaçlı kullanılmaktadır.

**ALTEA XL**
**5P5, 5P8**
**2006 - 2022**



Resim	Ürün Kodu ve Açıklaması	Detay	OEM
	<b>VW12124</b> MOTOR TAKOZU SOL VE SAĞ	Yön : Sol Ve Sağ Ağırlık : 1.927 kg / 4.248 lb	1K0199262A, 1K0199262AA 1K0199262AS
	<b>VW12106</b> ŞANZIMAN TAKOZU SOL ŞANZUMAN TAKOZU SOL	Yön : Sol Ağırlık : 1.95 kg / 4.299 lb Not : ŞANZUMAN TAKOZU SOL	1K0199555AT, 1K0199555T
	<b>AU12037</b> SÜSPANSİYON TAKOZU ARKA	Şasi (Ön / Arka) : ARKA Ağırlık : 0,095 kg / 0.209 lb	1K0511353J
	<b>VW12051</b> SÜSPANSİYON TAKOZU SOL VE SAĞ LASTİK DAYANAK SUSPENSİYON	Yön : Sol Ve Sağ Ağırlık : 0.045 kg / 0.099 lb Not : LASTİK DAYANAK SUSPENSİYON	1K0412303B
	<b>VW12086</b> RADYATÖR TAKOZU SOL VE SAĞ RADYATÖR ÜST LASTİĞİ	Yön : Sol Ve Sağ Ağırlık : 0.024 kg / 0.053 lb Not : RADYATÖR ÜST LASTİĞİ	1K0121367F
	<b>VW13006</b> DİREKSİYON KÖRÜĞÜ	Ağırlık : 0.145 kg / 0.320 lb	1K0423831A, 5C0423831
	<b>VW13006K</b> DİREKSİYON KÖRÜĞÜ SOL VE SAĞ 2 PIECES	Ağırlık : 0.29 kg / 0.639 lb	1K0423831A, 5C0423831
	<b>VW14003</b> AKS KÖRÜĞÜ +KELEPÇE+YAĞ. DIŞ	Ağırlık : 0.25 kg / 0.551 lb	1K0 498 203, 1K0498203
	<b>AU15001</b> AMORTİSÖR KÖRÜĞÜ ÖN	Şasi (Ön / Arka) : ÖN Ağırlık : 0,110 kg / 0.243 lb	6N0413175A

**ARONA**
**KJ7**
**2017 -**

Resim	Ürün Kodu ve Açıklaması	Detay	OEM
	<b>VW1014</b> ROTİL ÖN ALT SAĞ Ø15,6 RB2536	Ağırlık : 0,565 kg / 1.246 lb Konik Ölçüsü : Ø15,6 Bağlantı Delik Çapı : Ø10,5 Aşık Diş Çapı : M12X1,5	1K0407366B, 1K0407366C 1K0407366E, 5Q0407366A





\* Bu sayfada ve katalogdaki tüm araçların adları, markaları, modelleri, sembolleri, logoları, orjinal numaraları (oe) ve diğer üçüncü parti numaraları sadece referans amaçlı kullanılmaktadır.

**ARONA**
**KJ7**
**2017 -**





Resim	Ürün Kodu ve Açıklaması	Detay	OEM
	<b>VW1015</b> ROTİL ÖN ALT SOL Ø15,6 RB2537	Ağırlık : 0,565 kg / 1.246 lb Konik Ölçüsü : Ø15,6 Bağlantı Delik Çapı : Ø10,5 Aşık Diş Çapı : M12X1,5	1K0407365B, 1K0407365C 1K0407365E, 5Q0407365A
	<b>SE2008</b> ROTBAŞI SAĞ	Ağırlık : 0,426 kg / 0.939 lb Uzunluk : 95 mm / 3.74 inch Gövde Diş Çapı : M16X1,5 Aşık Diş Çapı : M12X1,5 Aşık Konik Çapı : Ø13,3	2Q0423812, 2QB423812
	<b>SE2009</b> ROTBAŞI SOL	Ağırlık : 0,426 kg / 0.939 lb Uzunluk : 95 mm / 3.74 inch Gövde Diş Çapı : M16X1,5 Aşık Diş Çapı : M12X1,5 Aşık Konik Çapı : Ø13,3	2Q0423811, 2QB423811
	<b>VW3025</b> ROTMİLİ SOL VE SAĞ 311	Ağırlık : 0,676 kg / 1.490 lb Uzunluk : 311 mm / 12.24 inch Gövde Diş Çapı : M14X1,5 Aşık Diş Çapı : M16X1,5	2Q0423810D
	<b>SK4004</b> Z ROT ÖM SAĞ-SOL L=270	Ağırlık : 0,266 kg / 0.586 lb Malzeme Türü : Metal Uzunluk : 270 mm / 10.63 inch	6R0411315
	<b>VW6063</b> SALINCAK ÖN ALT SAĞ	Ağırlık : 3,004 kg / 6.623 lb Malzeme Türü : Sac Metal	2Q0407152B
	<b>VW6063J</b> SALINCAK ÖN ALT SAĞ	Ağırlık : 2,439 kg / 5.377 lb Malzeme Türü : Sac Metal	2Q0407152B
	<b>VW6064</b> SALINCAK ÖN ALT SOL	Ağırlık : 3,004 kg / 6.623 lb Malzeme Türü : Sac Metal	2Q0407151B
	<b>VW6064J</b> SALINCAK ÖN ALT SOL	Ağırlık : 2,439 kg / 5.377 lb Malzeme Türü : Sac Metal	2Q0407151B
	<b>VW6065</b> SALINCAK ÖN ALT SAĞ	Ağırlık : 3,57 kg / 7.871 lb Malzeme Türü : Sac Metal	2Q0407152C
	<b>VW6065J</b> SALINCAK ÖN ALT SAĞ	Ağırlık : 2,964 kg / 6.535 lb Malzeme Türü : Sac Metal	2Q0407152C

\* Bu sayfada ve katalogdaki tüm araçların adları, markaları, modelleri, sembolleri, logoları, orijinal numaraları (oe) ve diğer üçüncü parti numaraları sadece referans amaçlı kullanılmaktadır.

**ARONA**
**KJ7**
**2017 -**











Resim	Ürün Kodu ve Açıklaması	Detay	OEM
	<b>VW6066</b> SALINCAK ÖN ALT SOL	Ağırlık : 3,57 kg / 7.871 lb Malzeme Türü : Sac Metal	2Q0407151C
	<b>VW6066J</b> SALINCAK ÖN ALT SOL	Ağırlık : 2,964 kg / 6.535 lb Malzeme Türü : Sac Metal	2Q0407151C
	<b>AU11005</b> SALINCAK VE DENGE KOLU BURCU ÖN ORTA SOL VE SAĞ B40115	Şasi (Ön / Arka) : ÖN Yön : Orta Sol Ve Sağ Ağırlık : 0,111 kg / 0.245 lb Not : VW6014 - VW60614J	191407182, 357407182 357407182F
	<b>AU12027</b> AMORTİSÖR TAKOZU ARKA ÜST SAĞ	Şasi (Ön / Arka) : ARKA Yön : Üst Sağ Ağırlık : 0,415 kg / 0.915 lb	5Q0513353H
	<b>AU12022</b> MOTOR TAKOZU SOL VE SAĞ MOTOR TAKOZU	Yön : Sol Ve Sağ Ağırlık : 1.58 kg / 3.483 lb Malzeme Türü : Motor Takoza	5Q0199262, 5Q0199262BH 5Q0199262DE
	<b>SK12005</b> MOTOR TAKOZU ÖN SAĞ	Şasi (Ön / Arka) : ÖN Yön : Sağ Ağırlık : 1,575 kg / 3.472 lb	5Q0199262CK

**AROSA**
**6H**
**1997 - 2004**

Resim	Ürün Kodu ve Açıklaması	Detay	OEM
	<b>VW1028</b> ROTİL ÖN SAĞ Ø14,7	Ağırlık : 0,39 kg / 0.860 lb Konik Ölçüsü : Ø14,7 Bağlantı Delik Çapı : Ø8,5 Aşık Diş Çapı : M10X1	6N0407366
	<b>VW1028K</b> ROTİL ALT SAĞ RD0523	Ağırlık : 0,455 kg / 1.003 lb Konik Ölçüsü : Ø14,7 Bağlantı Delik Çapı : Ø8,5 Aşık Diş Çapı : M10X1	6E0307366, 6N0407366* 6N0407366A
	<b>VW1029</b> ROTİL ÖN SOL Ø14,7	Ağırlık : 0,39 kg / 0.860 lb Konik Ölçüsü : Ø14,7 Bağlantı Delik Çapı : Ø8,5 Aşık Diş Çapı : M10X1	6N0407365, 6N0407365A
	<b>VW1029K</b> ROTİL ALT SOL RD0524	Ağırlık : 0,455 kg / 1.003 lb Konik Ölçüsü : Ø14,7 Bağlantı Delik Çapı : Ø8,5 Aşık Diş Çapı : M10X1	6N0407365*, 6N0407365 6N0407365A











\* Bu sayfada ve katalogdaki tüm araçların adları, markaları, modelleri, sembolleri, logoları, orijinal numaraları (oe) ve diğer üçüncü parti numaraları sadece referans amaçlı kullanılmaktadır.

**AROSA**
**6H**
**1997 - 2004**

Resim	Ürün Kodu ve Açıklaması	Detay	OEM
	<b>VW2006</b> ROTBAŞI SAĞ RD0312	Ağırlık : 0,3 kg / 0.661 lb Uzunluk : 76 mm / 2.99 inch Gövde Diş Çapı : M14X1,5 Aşık Diş Çapı : M12X1,5 Aşık Konik Çapı : Ø12,7	191419812, 22190091617 6N0419812, 6N0422812 XA2087
	<b>VW2007</b> ROTBAŞI SOL RD0311	Ağırlık : 0,3 kg / 0.661 lb Uzunluk : 76 mm / 2.99 inch Gövde Diş Çapı : M14X1,5 Aşık Diş Çapı : M12X1,5 Aşık Konik Çapı : Ø12,7	191419811, 22190090617 6N0419811, 6N0422811 XA2084
	<b>VW2022</b> ROTBAŞI SAĞ RD0336	Ağırlık : 0,357 kg / 0.787 lb Uzunluk : 93,5 mm / 3.68 inch Gövde Diş Çapı : M14X1,5 Aşık Diş Çapı : M12X1,5 Aşık Konik Çapı : Ø12,6	6E0419812, 6K0422812 6X0422812, 8Z0419812A
	<b>VW2023</b> ROTBAŞI SOL RD0335	Ağırlık : 0,354 kg / 0.780 lb Uzunluk : 93,5 mm / 3.68 inch Gövde Diş Çapı : M14X1,5 Aşık Diş Çapı : M12X1,5 Aşık Konik Çapı : Ø12,6	6E0419811, 6K0422811 6X0422811, 8Z0419811A
	<b>SK3003</b> ROTMİLİ SAĞ-SOL 297	Ağırlık : 0,552 kg / 1.217 lb Uzunluk : 297 mm / 11.69 inch Gövde Diş Çapı : M14X1,5 Aşık Diş Çapı : M14X1,5	6Q0 423 821 B, 6Q0423821B 6X0422803, 6X0422804 6X0422807, 6X0422821
	<b>VW3015</b> ROTMİLİ SAĞ-SOL HİDROLİK 309 RD0867	Ağırlık : 0,592 kg / 1.305 lb Uzunluk : 313 mm / 12.32 inch Gövde Diş Çapı : M14X1,5 Aşık Diş Çapı : M14X1,5	6N0422803A, 6N0422804A 6N0422807A, 6N0422821A 6X0422821
	<b>VW3016</b> ROTMİLİ SAĞ-SOL MANUEL 321 RD0864	Ağırlık : 0,602 kg / 1.327 lb Uzunluk : 296 mm / 11.65 inch Gövde Diş Çapı : M22X1,5 Aşık Diş Çapı : M14X1,5	6N0419803, 6N0419804 6N0419821
	<b>VW3018</b> ROTMİLİ ÖN SAĞ-SOL	Ağırlık : 0,552 kg / 1.217 lb Uzunluk : 297 mm / 11.69 inch Gövde Diş Çapı : M14X1,5 Aşık Diş Çapı : M14X1,5	6X0422803, 6X0422804 6X0422807, 6X0422821
	<b>VW3022</b> ROTMİLİ SAĞ-SOL L=292MM	Ağırlık : 0,57 kg / 1.257 lb Uzunluk : 292 mm / 11.50 inch Gövde Diş Çapı : M14X1,5 Aşık Diş Çapı : M14X1,5	6N0422803C*, 6N0422803C 6N0422804C*, 6N0422804C
	<b>VW20063015</b> ROT TAKIMI ÖN AKS SAĞ RD088165	Ağırlık : 0,89 kg / 1.962 lb Rotbaşı : VW2006 Rotmilî : VW3015	6N0422804A
	<b>VW20063016</b> ROT TAKIMI ÖN AKS SAĞ RD088163	Ağırlık : 0,91 kg / 2.006 lb Rotbaşı : VW2006 Rotmilî : VW3016	3A0419804, 6N0419804 6N0419804A, 6X0419804A

\* Bu sayfada ve katalogdaki tüm araçların adları, markaları, modelleri, sembolleri, logoları, orijinal numaraları (oe) ve diğer üçüncü parti numaraları sadece referans amaçlı kullanılmaktadır.

**AROSA**
**6H**
**1997 - 2004**

Resim	Ürün Kodu ve Açıklaması	Detay	OEM
	<b>VW20073015</b> ROT TAKIMI ÖN AKS SOL RD088166	Ağırlık : 0,893 kg / 1.969 lb Rotbaşı : VW2007 Rotmili : VW3015	6N0422803A
	<b>VW20073016</b> ROT TAKIMI ÖN AKS SOL RD088145	Ağırlık : 0,916 kg / 2.019 lb Rotbaşı : VW2007 Rotmili : VW3016	155422803, 175422803 55422803A, 6N0419803A 6X0419803A
	<b>VW20223022</b> ROT TAKIMI ÖN AKS SAĞ	Ağırlık : 0,94 kg / 2.072 lb Rotbaşı : VW2022 Rotmili : VW3022	6N0422804C
	<b>VW2022SK3003</b> ROT TAKIMI ÖN SAĞ	Ağırlık : 0,89 kg / 1.962 lb Rotbaşı : VW2022 Rotmili : SK3003	6N0422804
	<b>VW20233022</b> ROT TAKIMI SOL	Ağırlık : 0,94 kg / 2.072 lb Rotbaşı : VW2023 Rotmili : VW3022	6N0422803C
	<b>VW2023SK3003</b> ROT TAKIMI ÖN SOL	Ağırlık : 0,89 kg / 1.962 lb Rotbaşı : VW2023 Rotmili : SK3003	6N0422803
	<b>VW4022</b> Z ROT ÖN SAĞ-SOL 18MM 75 RD0931	Ağırlık : 0,166 kg / 0.366 lb Malzeme Türü : Metal Uzunluk : 76 mm / 2.99 inch Aşık Diş Çapı : M8X1,25	6N0411315A, 6N0411315D
	<b>VW4025</b> Z ROT ÖN SAĞ-SOL 15MM 75 RD0925	Ağırlık : 0,173 kg / 0.381 lb Uzunluk : 30 mm / 1.18 inch	6N0411315
	<b>VW6023</b> SALINCAK ÖN SAĞ RD1023	Ağırlık : 2,49 kg / 5.490 lb Malzeme Türü : Sac Metal	6N0407151*, 6N0407151A 6N0407365A*, 6X0407151A
	<b>VW6023J</b> SALINCAK ÖN RD1107	Ağırlık : 2,05 kg / 4.519 lb Malzeme Türü : Sac Metal	6N0407151, 6N0407151B
	<b>VW6024</b> SALINCAK ÖN SOL RD1024	Ağırlık : 2,319 kg / 5.113 lb Malzeme Türü : Sac Metal	6N0407151*, 6N0407365*

\* Bu sayfada ve katalogdaki tüm araçların adları, markaları, modelleri, sembolleri, logoları, orjinal numaraları (oe) ve diğer üçüncü parti numaraları sadece referans amaçlı kullanılmaktadır.

**AROSA**
**6H**
**1997 - 2004**









Resim	Ürün Kodu ve Açıklaması	Detay	OEM
	<b>VW11022</b> SALINCAK VE DENGE KOLU BURCU ORTA SOL VE SAĞ B40122	Yön : Orta Sol Ve Sağ Ağırlık : 0,081 kg / 0.179 lb	6N0407182
	<b>VW11041</b> SALINCAK VE DENGE KOLU BURCU SOL VE SAĞ B40121	Yön : Sol Ve Sağ Ağırlık : 0,156 kg / 0.344 lb	, 6N0407181
	<b>VW12068</b> TORSİYON BURCU ARKA SOL VE SAĞ	Şasi (Ön / Arka) : ARKA Yön : Sol Ve Sağ Ağırlık : 0.166 kg / 0.366 lb	6N0501541, 6N0501541D
	<b>VW12068K</b> TORSİYON BURCU ARKA SOL VE SAĞ	Şasi (Ön / Arka) : ARKA Yön : Sol Ve Sağ Ağırlık : 0.332 kg / 0.732 lb	6N0501541, 6N0501541D
	<b>VW12111</b> VİRAJ DEMİR LASTİĞİ SOL VE SAĞ RUBBER	Şasi (Ön / Arka) : ÖN Yön : Sol Ve Sağ Ağırlık : 0.015 kg / 0.033 lb Malzeme Türü : Rubber Not : VİRAJ LASTİĞİ	191411329, 6N0411329
	<b>VW12111K</b> VİRAJ DEMİR LASTİĞİ SOL VE SAĞ RUBBER	Şasi (Ön / Arka) : ÖN Yön : Sol Ve Sağ Ağırlık : 0.03 kg / 0.066 lb Malzeme Türü : Rubber	191411329*, 6N0411329*
	<b>VW12072</b> MOTOR TAKOZU SOL VE SAĞ ŞANZİMAN TAKOZU	Yön : Sol Ve Sağ Ağırlık : 1.628 kg / 3.589 lb Not : ŞANZİMAN TAKOZU	6N0199555H
	<b>VW12079</b> MOTOR TAKOZU SOL VE SAĞ ŞANZUMAN TAKOZU	Yön : Sol Ve Sağ Ağırlık : 1.44 kg / 3.175 lb Not : ŞANZUMAN TAKOZU	6N0199555AA, 6N0199555E 6N0199555F, 6N0199555G
	<b>VW13007</b> DİREKSİYON KÖRÜĞÜ	Ağırlık : 0.128 kg / 0.282 lb	6N0422831
	<b>F114014</b> AKS KÖRÜĞÜ +KELEPÇE+YAĞ. DIŞ	Ağırlık : 0.211 kg / 0.465 lb	46307841
	<b>VW15002</b> AMORTİSÖR KÖRÜĞÜ ARKA	Şasi (Ön / Arka) : ARKA	900064

\* Bu sayfada ve katalogdaki tüm araçların adları, markaları, modelleri, sembolleri, logoları, orijinal numaraları (oe) ve diğer üçüncü parti numaraları sadece referans amaçlı kullanılmaktadır.

**ATECA**
**I**
**2018 -**

Resim	Ürün Kodu ve Açıklaması	Detay	OEM
	<b>AU11080</b> BEŞİK (TRAVERS) BURCU ÖN ALT	Şasi (Ön / Arka) : ÖN Yön : Alt Ağırlık : 0,135 kg / 0.298 lb	5Q0505553











**ATECA**
**NU7**
**2018 -**

Resim	Ürün Kodu ve Açıklaması	Detay	OEM
	<b>VW1019</b> ROTİL ÖN SAĞ Ø15,3 RB2538	Ağırlık : 0,555 kg / 1.224 lb Konik Ölçüsü : Ø15,3 Bağlantı Delik Çapı : Ø10,5 Aşık Diş Çapı : M12X1,5	3C0407366A
	<b>VW1020</b> ROTİL ÖN SOL Ø15,3 RB2539	Ağırlık : 0,555 kg / 1.224 lb Konik Ölçüsü : Ø15,3 Bağlantı Delik Çapı : Ø10,5 Aşık Diş Çapı : M12X1,5	3C0407365A
	<b>VW2008</b> ROTBAŞI ÖN SAĞ RD0342	Ağırlık : 0,412 kg / 0.908 lb Uzunluk : 95 mm / 3.74 inch Gövde Diş Çapı : M16X1,5 Aşık Diş Çapı : M12X1,5 Aşık Konik Çapı : Ø12,7	1K0423812A, 1K0423812C 1K0423812E, 1K0423812G 1K0423812J, 1K0423812K 1KD423812A
	<b>VW2009</b> ROTBAŞI ÖN SOL RD0343	Ağırlık : 0,412 kg / 0.908 lb Uzunluk : 95 mm / 3.74 inch Gövde Diş Çapı : M16X1,5 Aşık Diş Çapı : M12X1,5 Aşık Konik Çapı : Ø13,5	1K0423811A, 1K0423811C 1K0423811E, 1K0423811G 1K0423811J, 1K0423811K 1KD423811A
	<b>VW3021</b> ROTMİLİ SAĞ-SOL	Ağırlık : 0,705 kg / 1.554 lb Uzunluk : 330 mm / 12.99 inch	561423810
	<b>VW3026</b> ROTMİLİ ÖN	Ağırlık : 0,695 kg / 1.532 lb Uzunluk : 350 mm / 13.78 inch	5WA423810D
	<b>VW20083021</b> ROT TAKIMI ÖN AKS SAĞ	Ağırlık : 1,2 kg / 2.646 lb Rotbaşı : VW2008 Rotmili : VW3021	561423810, 561423810S1
	<b>VW20093021</b> ROT TAKIMI ÖN SOL	Ağırlık : 1,2 kg / 2.646 lb Rotbaşı : VW2009 Rotmili : VW3021	561423810 S2, 561423810
	<b>SK4005</b> Z ROT ÖM SAĞ-SOL L=335MM	Ağırlık : 0,322 kg / 0.710 lb Malzeme Türü : Metal Uzunluk : 335 mm / 13.19 inch Aşık Diş Çapı : M12X1,5	5Q0411315B

\* Bu sayfada ve katalogdaki tüm araçların adları, markaları, modelleri, sembolleri, logoları, orjinal numaraları (oe) ve diğer üçüncü parti numaraları sadece referans amaçlı kullanılmaktadır.





**ATECA**
**NU7**
**2018 -**

Resim	Ürün Kodu ve Açıklaması	Detay	OEM
	<b>AU9009</b> SALINCAK ALT SOL VE SAĞ	Ağırlık : 2,910 kg / 6.415 lb Malzeme Türü : Sac Metal	5Q0505311C, 5Q0505311D
	<b>AU9012</b> SALINCAK ARKA ALT SAĞ	Ağırlık : 1,640 kg / 3.616 lb Malzeme Türü : Sac Metal	5Q0505224D
	<b>AU9013</b> SALINCAK ARKA ALT SOL	Ağırlık : 1,640 kg / 3.616 lb Malzeme Türü : Sac Metal	5Q0505223D
	<b>VW6055</b> SALINCAK ÖN ALT SAĞ	Ağırlık : 3,768 kg / 8.307 lb Malzeme Türü : Sac Metal	3Q0407152E*, 3Q0407152E 3Q0407152F*, 3Q0407152F 3Q0407154B*, 3Q0407154B
	<b>VW6055J</b> SALINCAK ÖN ALT SAĞ	Malzeme Türü : Sac Metal	3Q0407152E, 3Q0407152F 3Q0407154B
	<b>VW6056</b> SALINCAK ÖN ALT SOL	Ağırlık : 3,768 kg / 8.307 lb Malzeme Türü : Sac Metal	3Q0407151E*, 3Q0407151E 3Q0407151F*, 3Q0407151F 3Q0407153B*, 3Q0407153B
	<b>VW6056J</b> SALINCAK ÖN ALT SOL	Malzeme Türü : Sac Metal	3Q0407151E, 3Q0407151F 3Q0407153B
	<b>AU11068</b> SALINCAK VE DENGİ KOLU BURCU ARKA ALT SOL VE SAĞ METAL	Şasi (Ön / Arka) : ARKA Yön : Alt Sol Ve Sağ Ağırlık : 0,201 kg / 0.443 lb Malzeme Türü : Metal	PART OF 5Q0505223D, PART OF 5Q0505224D
	<b>AU11070</b> SALINCAK VE DENGİ KOLU BURCU ARKA ALT	Şasi (Ön / Arka) : ARKA Yön : Alt Ağırlık : 0,100 kg / 0.220 lb	5Q0505171, 5Q0505311C 5Q0505311CSK, 5Q0505311D 5Q0505311DSK
	<b>VW11042</b> SALINCAK VE DENGİ KOLU BURCU ORTA SOL VE SAĞ	Yön : Orta Sol Ve Sağ Ağırlık : 0,182 kg / 0.401 lb	1K0407182, 5Q0407182
	<b>VW11063</b> SALINCAK VE DENGİ KOLU BURCU SOL VE SAĞ	Yön : Sol Ve Sağ Ağırlık : 0.34 kg / 0.750 lb	5Q0407183D, 5Q0407183E

\* Bu sayfada ve katalogdaki tüm araçların adları, markaları, modelleri, sembolleri, logoları, orjinal numaraları (oe) ve diğer üçüncü parti numaraları sadece referans amaçlı kullanılmaktadır.

**ATECA NU7 2018 -**

Resim	Ürün Kodu ve Açıklaması	Detay	OEM
	<b>AU12022</b> MOTOR TAKOZU SOL VE SAĞ MOTOR TAKOZU	Yön : Sol Ve Sağ Ağırlık : 1.58 kg / 3.483 lb Malzeme Türü : Motor Takozu	5Q0199262, 5Q0199262BH 5Q0199262DE
	<b>SK12005</b> MOTOR TAKOZU ÖN SAĞ	Şasi (Ön / Arka) : ÖN Yön : Sağ Ağırlık : 1,575 kg / 3.472 lb	5Q0199262CK
	<b>VW12086</b> RADYATÖR TAKOZU SOL VE SAĞ RADYATÖR ÜST LASTİĞİ	Yön : Sol Ve Sağ Ağırlık : 0.024 kg / 0.053 lb Not : RADYATÖR ÜST LASTİĞİ	1K0121367F

**CORDOBA 6K1, 6K2 1993 - 1999**

Resim	Ürün Kodu ve Açıklaması	Detay	OEM
	<b>VW1012</b> ROTİL ALT SOL VE SAĞ	Ağırlık : 0,353 kg / 0.778 lb Bağlantı Delik Çapı : Ø8,5	357407365, 357407365A
	<b>VW1012K</b> ROTİL ALT SAĞ-SOL 19 RD0515	Ağırlık : 0,445 kg / 0.981 lb Bağlantı Delik Çapı : Ø8,5	357407365, 357407365A* 357407365A, 357407365S 357407365-S1
	<b>VW1013</b> ROTİL ÖN ALT Ø16,5 RD0519	Ağırlık : 0,415 kg / 0.915 lb Konik Ölçüsü : Ø16,5 Bağlantı Delik Çapı : Ø8,5 Aşık Diş Çapı : M12X1,5	1H0407365
	<b>VW1013K</b> ROTİL	Ağırlık : 0,495 kg / 1.091 lb Konik Ölçüsü : Ø16,5 Bağlantı Delik Çapı : Ø8,5 Aşık Diş Çapı : M12X1,5	1H0407365*, 1H0407365
	<b>VW2006</b> ROTBAŞI SAĞ RD0312	Ağırlık : 0,3 kg / 0.661 lb Uzunluk : 76 mm / 2.99 inch Gövde Diş Çapı : M14X1,5 Aşık Diş Çapı : M12X1,5 Aşık Konik Çapı : Ø12,7	191419812, 22190091617 6N0419812, 6N0422812 XA2087
	<b>VW2007</b> ROTBAŞI SOL RD0311	Ağırlık : 0,3 kg / 0.661 lb Uzunluk : 76 mm / 2.99 inch Gövde Diş Çapı : M14X1,5 Aşık Diş Çapı : M12X1,5 Aşık Konik Çapı : Ø12,7	191419811, 22190090617 6N0419811, 6N0422811 XA2084
	<b>VW3003</b> ROTMİLİ SAĞ-SOL RD0817	Ağırlık : 0,678 kg / 1.495 lb Uzunluk : 340 mm / 13.39 inch Gövde Diş Çapı : M22X1,5 Aşık Diş Çapı : M14X1,5	191419721, 191419803 191419803-PART, 191419804* 191419804, 191419807A 191419821

\* Bu sayfada ve katalogdaki tüm araçların adları, markaları, modelleri, sembolleri, logoları, orjinal numaraları (oe) ve diğer üçüncü parti numaraları sadece referans amaçlı kullanılmaktadır.

**CORDOBA**
**6K1, 6K2**
**1993 - 1999**

Resim	Ürün Kodu ve Açıklaması	Detay	OEM
	<b>VW3004</b> ROTMİLİ ÖN SAĞ - SOL 338 RD0887	Ağırlık : 0,605 kg / 1.334 lb Uzunluk : 338 mm / 13.31 inch Gövde Diş Çapı : M14X1,5 Aşık Diş Çapı : M14X1,5	191407153, 191422721 191422803A, 191422804A 191422807, 191422807A 191422821, 191422821A 6K0422821
	<b>VW20063003</b> ROT TAKIMI SAĞ RD088116	Ağırlık : 0,984 kg / 2.169 lb Rotbaşı : VW2006 Rotmili : VW3003	191419804, 191419804A
	<b>VW20063004</b> ROT TAKIMI ÖN AKS SAĞ	Ağırlık : 0,991 kg / 2.185 lb Rotbaşı : VW2006 Rotmili : VW3004	191422804A
	<b>VW20073003</b> ROT TAKIMI SOL RD088115	Ağırlık : 0,978 kg / 2.156 lb Rotbaşı : VW2007 Rotmili : VW3003	191419803, 191419803A
	<b>VW20073004</b> ROT TAKIMI SOL RD088118	Ağırlık : 0,991 kg / 2.185 lb Rotbaşı : VW2007 Rotmili : VW3004	191422803, 191422803A
	<b>VW4004</b> Z ROT ÖN SAĞ - SOL KOMPLE RD0942	Ağırlık : 0,189 kg / 0.417 lb Malzeme Türü : Komple Uzunluk : 75 mm / 2.95 inch	191411315, 191411315B 191411315BKIT, 191411315BS
	<b>VW4008</b> Z ROT ÖN SAĞ - SOL METAL RD0923	Ağırlık : 0,166 kg / 0.366 lb Malzeme Türü : Metal Uzunluk : 77 mm / 3.03 inch Aşık Diş Çapı : M8X1,25	191411315A, 191411315B 191411315BK
	<b>VW6004J</b> SALINCAK ÖN RD1103	Ağırlık : 2,605 kg / 5.743 lb Malzeme Türü : Sac Metal	191.407.151B, 191407151A 191407151B
	<b>VW6006</b> SALINCAK ÖN SAĞ RD1019	Ağırlık : 3,166 kg / 6.980 lb Malzeme Türü : Sac Metal	191407151B, 191407175 191411315B, 191411331 357407365A, 6N0411329 N0111849, N10127702
	<b>VW60066007K</b> SALINCAK ÖN	Ağırlık : 3.3 kg / 7.275 lb Malzeme Türü : Sac Metal	
	<b>VW600674008K</b> SALINCAK ÖN	Ağırlık : 3.466 kg / 7.641 lb Malzeme Türü : Sac Metal	

\* Bu sayfada ve katalogdaki tüm araçların adları, markaları, modelleri, sembolleri, logoları, orjinal numaraları (oe) ve diğer üçüncü parti numaraları sadece referans amaçlı kullanılmaktadır.

**CORDOBA**
**6K1, 6K2**
**1993 - 1999**

Resim	Ürün Kodu ve Açıklaması	Detay	OEM
	<b>VW6007</b> SALINCAK ÖN SOL RD1029	Ağırlık : 3,088 kg / 6.808 lb Malzeme Türü : Sac Metal	191407151A
	<b>VW6014</b> SALINCAK ÖN SAĞ RD1021	Ağırlık : 3,966 kg / 8.744 lb Malzeme Türü : Sac Metal	1H0407152*
	<b>VW6014J</b> SALINCAK ÖN SAĞ RD1106	Ağırlık : 3,35 kg / 7.385 lb Malzeme Türü : Sac Metal	1H0407152
	<b>VW6015</b> SALINCAK ÖN SOL RD1022	Ağırlık : 3,674 kg / 8.100 lb Malzeme Türü : Sac Metal	1H0407151A *, 1H0407151A*
	<b>VW6015J</b> SALINCAK ÖN SOL RD1105	Ağırlık : 3,152 kg / 6.949 lb Malzeme Türü : Sac Metal	1H0.407.151A, 1H0407151 1H0407151A
	<b>AU11005</b> SALINCAK VE DENGE KOLU BURCU ÖN ORTA SOL VE SAĞ B40115	Şasi (Ön / Arka) : ÖN Yön : Orta Sol Ve Sağ Ağırlık : 0,111 kg / 0.245 lb Not : VW6014 - VW60614J	191407182, 357407182 357407182F
	<b>VW11001</b> SALINCAK VE DENGE KOLU BURCU SOL VE SAĞ B40114	Yön : Sol Ve Sağ Ağırlık : 0,141 kg / 0.311 lb	191407181D, 191407181E 357407181
	<b>VW11036</b> SALINCAK VE DENGE KOLU BURCU SOL VE SAĞ	Yön : Sol Ve Sağ Ağırlık : 0,07 kg / 0.154 lb Not : BORUSU	191411315B, 4A0399413A
	<b>VW11840</b> BURÇ	Yön : Sol Ve Sağ Ağırlık : 0,149 kg / 0.328 lb	357407181
	<b>VW12060</b> TORSİYON BURCU SOL VE SAĞ	Yön : Sol Ve Sağ Ağırlık : 0,459 kg / 1.012 lb	191501541
	<b>VW12066</b> TORSİYON BURCU SOL VE SAĞ	Yön : Sol Ve Sağ Ağırlık : 0,6 kg / 1.323 lb	1J0 501 541 D, 1J0501541D









\* Bu sayfada ve katalogdaki tüm araçların adları, markaları, modelleri, sembolleri, logoları, orjinal numaraları (oe) ve diğer üçüncü parti numaraları sadece referans amaçlı kullanılmaktadır.

**CORDOBA**
**6K1, 6K2**
**1993 - 1999**

Resim	Ürün Kodu ve Açıklaması	Detay	OEM
	<b>VW12068</b> TORSİYON BURCU ARKA SOL VE SAĞ	Şasi (Ön / Arka) : ARKA Yön : Sol Ve Sağ Ağırlık : 0.166 kg / 0.366 lb	6N0501541, 6N0501541D
	<b>VW12068K</b> TORSİYON BURCU ARKA SOL VE SAĞ	Şasi (Ön / Arka) : ARKA Yön : Sol Ve Sağ Ağırlık : 0.332 kg / 0.732 lb	6N0501541, 6N0501541D
	<b>VW12037</b> VİRAJ DEMİR LASTİĞİ SOL VE SAĞ RUBBER	Şasi (Ön / Arka) : ÖN Yön : Sol Ve Sağ Ağırlık : 0.11 kg / 0.243 lb Malzeme Türü : Rubber Not : VİRAJ DEMİR LASTİĞİ ÖN	191411314
	<b>VW12037K</b> VİRAJ DEMİR LASTİĞİ SOL VE SAĞ RUBBER	Şasi (Ön / Arka) : ÖN Yön : Sol Ve Sağ Ağırlık : 0.22 kg / 0.485 lb Malzeme Türü : Rubber	191411314*
	<b>VW12111</b> VİRAJ DEMİR LASTİĞİ SOL VE SAĞ RUBBER	Şasi (Ön / Arka) : ÖN Yön : Sol Ve Sağ Ağırlık : 0.015 kg / 0.033 lb Malzeme Türü : Rubber Not : VİRAJ LASTİĞİ	191411329, 6N0411329
	<b>VW12111K</b> VİRAJ DEMİR LASTİĞİ SOL VE SAĞ RUBBER	Şasi (Ön / Arka) : ÖN Yön : Sol Ve Sağ Ağırlık : 0.03 kg / 0.066 lb Malzeme Türü : Rubber	191411329*, 6N0411329*
	<b>VW12001</b> AMORTİSÖR TAKOZU SOL VE SAĞ AMORTİSÖR TAKOZU	Yön : Sol Ve Sağ Ağırlık : 0.644 kg / 1.420 lb Not : AMORTİSÖR TAKOZU	176412329, 191412329 191412331
	<b>VW12005</b> AMORTİSÖR TAKOZU SOL VE SAĞ AMORTİSÖR ÜST TAKOZU	Yön : Sol Ve Sağ Ağırlık : 0.1 kg / 0.220 lb Not : AMORTİSÖR ÜST TAKOZU	191512333
	<b>VW12109</b> AMORTİSÖR TAKOZU SOL VE SAĞ AMORTİSÖR RULMANI	Yön : Sol Ve Sağ Ağırlık : 0.26 kg / 0.573 lb Not : AMORTİSÖR RULMANI	6N0412249C, 6N0412249E
	<b>VW12109K</b> AMORTİSÖR TAKOZU SOL VE SAĞ 2 PCS	Yön : Sol Ve Sağ Ağırlık : 0.52 kg / 1.146 lb Not : 2 PCS	6N0412249C, 6N0412249E
	<b>VW12115</b> AMORTİSÖR TAKOZU SOL VE SAĞ AMORTİSÖR TAKOZU	Yön : Sol Ve Sağ Ağırlık : 0.85 kg / 1.874 lb Not : AMORTİSÖR TAKOZU	6N0412331D, 6N0412331E 6Q0412331B



\* Bu sayfada ve katalogdaki tüm araçların adları, markaları, modelleri, sembolleri, logoları, orjinal numaraları (oe) ve diğer üçüncü parti numaraları sadece referans amaçlı kullanılmaktadır.

**CORDOBA**
**6K1, 6K2**
**1993 - 1999**







Resim	Ürün Kodu ve Açıklaması	Detay	OEM
	<b>VW12801</b> AMORTİSÖR TAKOZU SOL VE SAĞ KIT = VW12115 AND VW12109	Yön : Sol Ve Sağ Ağırlık : 1.269 kg / 2.798 lb Not : KIT = VW12115 and VW12109	6N0412249C, 6N0412249E 6N0412331D, 6N0412331E 6Q0412331B
	<b>VW12008</b> MOTOR TAKOZU SOL VE SAĞ MOTOR TAKOZU	Yön : Sol Ve Sağ Ağırlık : 0.574 kg / 1.265 lb Not : MOTOR TAKOZU	357199381C, 357199402B 3A0199402
	<b>VW12074</b> MOTOR TAKOZU SOL VE SAĞ MOTOR TAKOZU	Yön : Sol Ve Sağ Ağırlık : 1.08 kg / 2.381 lb Not : MOTOR TAKOZU	1H0199609B, 1H0199609F 1H0199609G, 1H0199609J
	<b>VW12092</b> MOTOR TAKOZU SAĞ MOTOR TAKOZU ARKA SAĞ	Yön : Sağ Ağırlık : 1,745 kg / 3.847 lb Not : MOTOR TAKOZU ARKA SAĞ	1H0199262B, 1H0199262G 1H0199262H
	<b>VW12098</b> MOTOR TAKOZU SOL VE SAĞ MOTOR TAKOZU	Yön : Sol Ve Sağ Ağırlık : 1,565 kg / 3.450 lb Not : MOTOR TAKOZU	1H0199262E
	<b>VW12089</b> SÜSPANSİYON TAKOZU SOL VE SAĞ SÜSPANSİYON TAKOZU	Yön : Sol Ve Sağ Ağırlık : 0.15 kg / 0.331 lb Not : SÜSPANSİYON TAKOZU	191412303A, 357412303E
	<b>VW12135</b> EGZOZ TAKOZU	Ağırlık : 0,155 kg / 0.342 lb	1H0253144, 1H0253144A 1H0253144C, 1H0253409C 6N0253144
	<b>VW13008</b> DİREKSİYON KÖRÜĞÜ	Ağırlık : 0.225 kg / 0.496 lb	1H0422831B
	<b>VW13010</b> DİREKSİYON KÖRÜĞÜ ÖN	Ağırlık : 0,124 kg / 0.273 lb	191422831
	<b>OP14003</b> AKS KÖRÜĞÜ +KELEPÇE+YAĞ. AKS KÖRÜĞÜ DIŞ	Ağırlık : 0.2 kg / 0.441 lb	1603180
	<b>RN14006</b> AKS KÖRÜĞÜ +KELEPÇE+YAĞ. DIŞ	Ağırlık : 0.2 kg / 0.441 lb	1603180, 1603204 16410170470106*, 16500170470106* 1H0498203, 271648 271649, 321498203A 431498203C, 443498203D

\* Bu sayfada ve katalogdaki tüm araçların adları, markaları, modelleri, sembolleri, logoları, orjinal numaraları (oe) ve diğer üçüncü parti numaraları sadece referans amaçlı kullanılmaktadır.

**CORDOBA**
**6K1, 6K2**
**1993 - 1999**

Resim	Ürün Kodu ve Açıklaması	Detay	OEM
	<b>VW14013</b> AKS KÖRÜĞÜ +KELEPÇE+YAĞ. YAĞ+KELEPÇE	Ağırlık : 0.156 kg / 0.344 lb	113501149, 171407283A
	<b>VW14014</b> AKS KÖRÜĞÜ +KELEPÇE+YAĞ. YAĞ+KELEPÇE	Ağırlık : 0.28 kg / 0.617 lb	191498203C, 71498203
	<b>AU15001</b> AMORTİSÖR KÖRÜĞÜ ÖN	Şasi (Ön / Arka) : ÖN Ağırlık : 0,110 kg / 0.243 lb	6N0413175A

**CORDOBA**
**6L2**
**2002 - 2009**

Resim	Ürün Kodu ve Açıklaması	Detay	OEM
	<b>SK1023</b> ROTİL SAĞ RD0530	Ağırlık : 0,46 kg / 1.014 lb Konik Ölçüsü : Ø15 Bağlantı Delik Çapı : Ø8,5 Aşık Dış Çapı : M12X1,5	6Q0407366A, 6Q0407366B 6Q0407366E, 6Q0407366M 8Z0407366A
	<b>SK1023K</b> ROTİL ÖN ALT SAĞ Ø15 KIT	Ağırlık : 0,5 kg / 1.102 lb Konik Ölçüsü : Ø15 Bağlantı Delik Çapı : Ø8,5 Aşık Dış Çapı : M12X1,5	6Q0407366A*, 6Q0407366A 6Q0407366B*, 6Q0407366E* 6Q0407366M*, 6Q0407366M 8Z0407366A*
	<b>SK1024</b> ROTİL SOL RD0531	Ağırlık : 0,46 kg / 1.014 lb Konik Ölçüsü : Ø15 Bağlantı Delik Çapı : Ø8,5 Aşık Dış Çapı : M12X1,5	6Q0407365A, 6Q0407365B 6Q0407365E, 6Q0407365M 8Z0407365A
	<b>SK1024K</b> ROTİL SOL	Ağırlık : 0,5 kg / 1.102 lb Konik Ölçüsü : Ø15 Bağlantı Delik Çapı : Ø8,5 Aşık Dış Çapı : M12X1,5	6Q0407365A*, 6Q0407365A 6Q0407365B*, 6Q0407365E* 6Q0407365E, 6Q0407365M* 6Q0407365M, 8Z0407365A*
	<b>SK2003</b> ROTBAŞI SAĞ RC7314	Ağırlık : 0,377 kg / 0.831 lb Uzunluk : 93,5 mm / 3.68 inch Gövde Dış Çapı : M14X1,5 Aşık Dış Çapı : M12X1,5 Aşık Konik Çapı : Ø13,5	5Z0423812, 6Q0419812C 6Q0423812, 6Q0423812A 6Q0423812C, 6Q0423812D 6R0423812, 8Z0423811A
	<b>SK2004</b> ROTBAŞI SOL RC7313	Ağırlık : 0,382 kg / 0.842 lb Uzunluk : 93 mm / 3.66 inch Gövde Dış Çapı : M14X1,5 Aşık Dış Çapı : M12X1,5 Aşık Konik Çapı : Ø13,5	5Z0423811, 6Q0419811C 6Q0423811, 6Q0423811A 6Q0423811C, 6Q0423811D 6R0423811, 8Z0423812A
	<b>SE3001</b> ROTMİLİ	Ağırlık : 0,63 kg / 1.389 lb Uzunluk : 320 mm / 12.60 inch Gövde Dış Çapı : M14X1,5 Aşık Dış Çapı : M14X1,5	6Q0423803E*, 6Q0423804E* 6Q0423810E*, 6Q0423810P*

\* Bu sayfada ve katalogdaki tüm araçların adları, markaları, modelleri, sembolleri, logoları, orjinal numaraları (oe) ve diğer üçüncü parti numaraları sadece referans amaçlı kullanılmaktadır.

**CORDOBA****6L2****2002 - 2009**





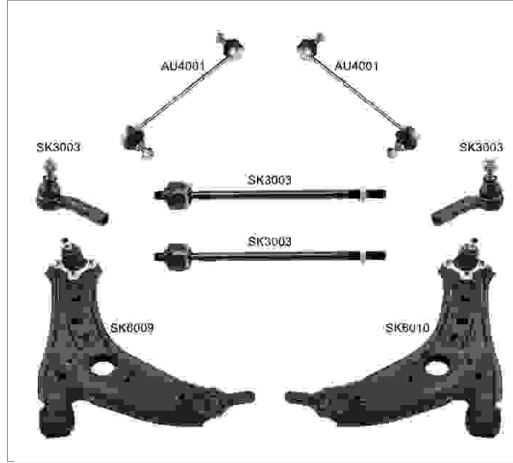





Resim	Ürün Kodu ve Açıklaması	Detay	OEM
	<b>SK3003</b> ROTMİLİ SAĞ-SOL 297	Ağırlık : 0,552 kg / 1.217 lb Uzunluk : 297 mm / 11.69 inch Gövde Diş Çapı : M14X1,5 Aşık Diş Çapı : M14X1,5	6Q0 423 821 B, 6Q0423821B 6X0422803, 6X0422804 6X0422807, 6X0422821
	<b>SK3004</b> ROTMİLİ SAĞ-SOL 300 RC7817	Ağırlık : 0,536 kg / 1.182 lb Uzunluk : 300 mm / 11.81 inch Gövde Diş Çapı : M16X1,5 Aşık Diş Çapı : M14X1,5	6Q0423803A, 6Q0423804A 6Q0-423-810-C, 6Q0423821A 6Q0423821C, 6Q0423821G



**SK8001 / Süspansiyon Kit**
**CORDOBA**
**6L2**
**2002 - 2009**

**Kit Parçaları**

Resim	Ürün Kodu / Adı	OEM	OEM	Ürün Kodu / Adı	Resim
	<b>AU4001</b> Z Rot Sol Ve Sağ Metal Rb2911	893407465, 893407465A 8A0407465, 8A0407465B 8A0407465C	5Z0423812, 6Q0419812C 6Q0423812, 6Q0423812A 6Q0423812C, 6Q0423812D 6R0423812, 8Z0423811A	<b>SK2003</b> Rotbaşı Sağ Rc7314	
	<b>SK2004</b> Rotbaşı Sol Rc7313	5Z0423811, 6Q0419811C 6Q0423811, 6Q0423811A 6Q0423811C, 6Q0423811D 6R0423811, 8Z0423812A	6Q0 423 821 B, 6Q0423821B 6X0422803, 6X0422804 6X0422807, 6X0422821	<b>SK3003</b> Rotmili Sağ-sol 297	
	<b>SK6009</b> Salıncak Ön Alt Sağ Rd1035	6N0407151, 6Q0407151D* 6Q0407151D, 6Q0407151E* 6Q0407151E, 6Q0407151L 6Q0407151Z, 6Q0407366A*	6N040711, 6Q0407151D* 6Q0407151D, 6Q0407151E* 6Q0407151E, 6Q0407151L 6Q0407151Z, 6Q0407365A*	<b>SK6010</b> Salıncak Ön Alt Sol Rd1036	

**CORDOBA**
**6L2**
**2002 - 2009**

Resim	Ürün Kodu ve Açıklaması	Detay	OEM
	<b>SK20033003</b> ROT TAKIMI ÖN AKS SAĞ RC788115	Ağırlık : 1,021 kg / 2.251 lb Rotbaşı : SK2003 Rotmilili : SK3003	6Q0422804B, 6Q0423804B
	<b>SK20033004</b> ROT TAKIMI ÖN AKS SAĞ RC788117	Ağırlık : 0,915 kg / 2.017 lb Rotbaşı : SK2003 Rotmilili : SK3004	6Q0422804G, 6Q0423804A
	<b>SK20043003</b> ROT TAKIMI SOL RC788114	Ağırlık : 0,932 kg / 2.055 lb Rotbaşı : SK2004 Rotmilili : SK3003	6Q0422803B, 6Q0423803B
	<b>SK20043004</b> ROT TAKIMI ÖN AKS SOL RC788116	Ağırlık : 0,903 kg / 1.991 lb Rotbaşı : SK2004 Rotmilili : SK3004	6Q0422803G, 6Q0423803A
	<b>AU4001</b> Z ROT SOL VE SAĞ METAL RB2911	Ağırlık : 0,357 kg / 0.787 lb Malzeme Türü : Metal Uzunluk : 270 mm / 10.63 inch Aşık Diş Çapı : M10X1,5	893407465, 893407465A 8A0407465, 8A0407465B 8A0407465C
	<b>AU4001A</b> Z ROT ÖN PLASTİK	Ağırlık : 0,295 kg / 0.650 lb Malzeme Türü : Plastik Uzunluk : 317 mm / 12.48 inch	893407465, 893407465A 8A0407465, 8A0407465B 8A0407465C
	<b>AU4028</b> Z ROT ÖN	Ağırlık : 0,368 kg / 0.811 lb Malzeme Türü : Metal Uzunluk : 270 mm / 10.63 inch Aşık Diş Çapı : M10X1,5	6Q0411315L, 6Q0411315N 8Z0411315D
	<b>SK6009</b> SALINCAK ÖN ALT SAĞ RD1035	Ağırlık : 2,676 kg / 5.900 lb Malzeme Türü : Sac Metal	6N0407151, 6Q0407151D* 6Q0407151D, 6Q0407151E* 6Q0407151E, 6Q0407151L 6Q0407151Z, 6Q0407366A*
	<b>SK6009J</b> SALINCAK ÖN ALT RD10211	Ağırlık : 2,626 kg / 5.789 lb Malzeme Türü : Sac Metal	6Q0407151D, 6Q0407151E 6Q0407151L
	<b>SK6009K</b> SALINCAK ÖN ALT SAĞ	Ağırlık : 3,13 kg / 6.900 lb Malzeme Türü : Sac Metal	6N0407151, 6Q0407151D 6Q0407151E, 6Q0407151L 6Q0407151Z
	<b>SK6010</b> SALINCAK ÖN ALT SOL RD1036	Ağırlık : 3,13 kg / 6.900 lb Malzeme Türü : Sac Metal	6N040711, 6Q0407151D* 6Q0407151D, 6Q0407151E* 6Q0407151E, 6Q0407151L 6Q0407151Z, 6Q0407365A*

\* Bu sayfada ve katalogdaki tüm araçların adları, markaları, modelleri, sembolleri, logoları, orjinal numaraları (oe) ve diğer üçüncü parti numaraları sadece referans amaçlı kullanılmaktadır.

**CORDOBA**
**6L2**
**2002 - 2009**

Resim	Ürün Kodu ve Açıklaması	Detay	OEM
	<b>SK6010K</b> SALINCAK ÖN ALT SOL	Ağırlık : 3,13 kg / 6.900 lb Malzeme Türü : Sac Metal	6N040711, 6Q0407151D* 6Q0407151D, 6Q0407151E* 6Q0407151E, 6Q0407151L 6Q0407151Z, 6Q0407365A*
	<b>VW11045</b> SALINCAK VE DENGE KOLU BURCU ORTA SOL VE SAĞ B40128	Yön : Orta Sol Ve Sağ Ağırlık : 0,145 kg / 0.320 lb	6Q0407182A
	<b>VW11047</b> SALINCAK VE DENGE KOLU BURCU İÇ SOL VE SAĞ B37117	Yön : İç Sol Ve Sağ Ağırlık : 0,121 kg / 0.267 lb	1K0199231J, 1K0199231J-P 1K0407183E
	<b>VW11051</b> SALINCAK VE DENGE KOLU BURCU SOL VE SAĞ	Yön : Sol Ve Sağ Ağırlık : 0.121 kg / 0.267 lb	6Q0407183, 6Q0407183A
	<b>VW11055</b> SALINCAK VE DENGE KOLU BURCU İÇ SOL VE SAĞ	Yön : İç Sol Ve Sağ Ağırlık : 0.121 kg / 0.267 lb	1K0407183E, 8J0407183
	<b>VW12010</b> TORSİYON BURCU SOL VE SAĞ	Yön : Sol Ve Sağ Ağırlık : 0.31 kg / 0.683 lb	1J0500045, 1J0500045A 1J0501541B, 1J0501541C 6R0501541A, 6R0501541B
	<b>VW12015</b> VİRAJ DEMİR LASTİĞİ SOL VE SAĞ RUBBER	Şasi (Ön / Arka) : ÖN Yön : Sol Ve Sağ Ağırlık : 0.03 kg / 0.066 lb Malzeme Türü : Rubber Not : VİRAJ DEMİR LASTİĞİ	6Q0411303H, 6Q0411314E 6Q0411314N, 6Q0411314R
	<b>VW12015K</b> VİRAJ DEMİR LASTİĞİ SOL VE SAĞ RUBBER	Şasi (Ön / Arka) : ÖN Yön : Sol Ve Sağ Ağırlık : 0.06 kg / 0.132 lb Malzeme Türü : Rubber Not : VİRAJ LASTİĞİ (İKİLİ)	6Q0411303H*, 6Q0411303H 6Q0411314E*, 6Q0411314E 6Q0411314N*, 6Q0411314N 6Q0411314R*, 6Q0411314R
	<b>VW12024</b> VİRAJ DEMİR LASTİĞİ SOL VE SAĞ RUBBER	Şasi (Ön / Arka) : ÖN Yön : Sol Ve Sağ Ağırlık : 0.03 kg / 0.066 lb Malzeme Türü : Rubber Not : VİRAJ LASTİĞİ	6Q0411303AA, 6Q0411303AD 6Q0411305H, 6Q0411314M 6Q0411314Q
	<b>VW12024K</b> VİRAJ DEMİR LASTİĞİ SOL VE SAĞ RUBBER	Şasi (Ön / Arka) : ÖN Yön : Sol Ve Sağ Ağırlık : 0.06 kg / 0.132 lb Malzeme Türü : Rubber Not : VİRAJ LASTİĞİ (İKİLİ)	6Q0411303AA*, 6Q0411303AA 6Q0411303AD*, 6Q0411303AD 6Q0411305H*, 6Q0411305H 6Q0411314M*, 6Q0411314M 6Q0411314Q*, 6Q0411314Q
	<b>VW12050</b> VİRAJ DEMİR LASTİĞİ SOL VE SAĞ RUBBER	Şasi (Ön / Arka) : ÖN Yön : Sol Ve Sağ Ağırlık : 0.04 kg / 0.088 lb Malzeme Türü : Rubber Not : VİRAJ LASTİĞİ	6Q0411314P

\* Bu sayfada ve katalogdaki tüm araçların adları, markaları, modelleri, sembolleri, logoları, orijinal numaraları (oe) ve diğer üçüncü parti numaraları sadece referans amaçlı kullanılmaktadır.

**CORDOBA**
**6L2**
**2002 - 2009**

Resim	Ürün Kodu ve Açıklaması	Detay	OEM
	<b>VW12050K</b> VİRAJ DEMİR LASTİĞİ SOL VE SAĞ RUBBER	Şasi (Ön / Arka) : ÖN Yön : Sol Ve Sağ Ağırlık : 0.08 kg / 0.176 lb Malzeme Türü : Rubber Not : VİRAJ LASTİĞİ (İKİLİ)	6Q0411314P*, 6Q0411314P
	<b>SK12002</b> AMORTİSÖR TAKOZU ARKA SOL VE SAĞ 1.2 / 1.4TSI / 1.6TDI / 1.2TDI	Şasi (Ön / Arka) : ARKA Yön : Sol Ve Sağ Ağırlık : 0,305 kg / 0.672 lb Not : 1.2 / 1.4TSI / 1.6TDI / 1.2TDI	1J0513353A, 1J0513353B 1J0513353C, 1J0513353G 6QE513353, 6R0513353 6R0513353B
	<b>VW12005</b> AMORTİSÖR TAKOZU SOL VE SAĞ AMORTİSÖR ÜST TAKOZU	Yön : Sol Ve Sağ Ağırlık : 0.1 kg / 0.220 lb Not : AMORTİSÖR ÜST TAKOZU	191512333
	<b>VW12109</b> AMORTİSÖR TAKOZU SOL VE SAĞ AMORTİSÖR RULMANI	Yön : Sol Ve Sağ Ağırlık : 0.26 kg / 0.573 lb Not : AMORTİSÖR RULMANI	6N0412249C, 6N0412249E
	<b>VW12109K</b> AMORTİSÖR TAKOZU SOL VE SAĞ 2 PCS	Yön : Sol Ve Sağ Ağırlık : 0.52 kg / 1.146 lb Not : 2 PCS	6N0412249C, 6N0412249E
	<b>VW12115</b> AMORTİSÖR TAKOZU SOL VE SAĞ AMORTİSÖR TAKOZU	Yön : Sol Ve Sağ Ağırlık : 0.85 kg / 1.874 lb Not : AMORTİSÖR TAKOZU	6N0412331D, 6N0412331E 6Q0412331B
	<b>VW12801</b> AMORTİSÖR TAKOZU SOL VE SAĞ KIT = VW12115 AND VW12109	Yön : Sol Ve Sağ Ağırlık : 1.269 kg / 2.798 lb Not : KIT = VW12115 and VW12109	6N0412249C, 6N0412249E 6N0412331D, 6N0412331E 6Q0412331B
	<b>VW12028</b> MOTOR TAKOZU SOL VE SAĞ MOTOR TAKOZU	Yön : Sol Ve Sağ Ağırlık : 1.1 kg / 2.425 lb Not : MOTOR TAKOZU	6Q0199851, 6Q0199851AK
	<b>VW12069</b> MOTOR TAKOZU SOL VE SAĞ MOTOR TAKOZU	Yön : Sol Ve Sağ Ağırlık : 0.83 kg / 1.830 lb Not : MOTOR TAKOZU	6Q0199851AB, 6Q0199851AK
	<b>VW12080</b> MOTOR TAKOZU SOL VE SAĞ MOTOR TAKOZU	Yön : Sol Ve Sağ Ağırlık : 2.02 kg / 4.453 lb Not : MOTOR TAKOZU	6Q0199167AQ, 6Q0199167BM 6Q0199167BQ, 6Q0199167BR 6Q0199167CA, 6Q0199167CB 6Q0199167CC, 6Q0199167CE 6Q0199167CJ, 6Q0199167CR
	<b>VW12083</b> MOTOR TAKOZU SOL VE SAĞ MOTOR TAKOZU	Yön : Sol Ve Sağ Ağırlık : 1.95 kg / 4.299 lb Not : MOTOR TAKOZU	6Q0199167BC, 6Q0199167BN 6Q0199167CH, 6Q0199167CL 6Q0199167DA, 6Q0199167DB 6Q0199167DL, 6Q0199167DM 6R0199167AA

\* Bu sayfada ve katalogdaki tüm araçların adları, markaları, modelleri, sembolleri, logoları, orijinal numaraları (oe) ve diğer üçüncü parti numaraları sadece referans amaçlı kullanılmaktadır.

**CORDOBA**
**6L2**
**2002 - 2009**

Resim	Ürün Kodu ve Açıklaması	Detay	OEM
	<b>VW12123</b> MOTOR TAKOZU SOL ŞANZUMAN TAKOZU	Yön : Sol Ağırlık : 1.642 kg / 3.620 lb Malzeme Türü : Şanzuman Takozu	6Q0199555AE, 6Q0199555AT 6R0199555, 6RF199555A 6RF199555C
	<b>VW12036</b> SÜSPANSİYON TAKOZU SOL VE SAĞ ARKA SÜSPANSİYON TAKOZU	Yön : Sol Ve Sağ Ağırlık : 1.591 kg / 3.508 lb Not : ARKA SÜSPANSİYON TAKOZU	6Q0512131B
	<b>SK12006</b> EGZOZ TAKOZU	Ağırlık : 0,185 kg / 0.408 lb	6Q0253144B, 6Q0253144D
	<b>AU14001</b> AKS KÖRÜĞÜ +KELEPÇE+YAĞ.	Ağırlık : 0.233 kg / 0.514 lb	6Q0498203A
	<b>F114014</b> AKS KÖRÜĞÜ +KELEPÇE+YAĞ. DIŞ	Ağırlık : 0.211 kg / 0.465 lb	46307841
	<b>VW14003</b> AKS KÖRÜĞÜ +KELEPÇE+YAĞ. DIŞ	Ağırlık : 0.25 kg / 0.551 lb	1K0 498 203, 1K0498203
	<b>VW14009</b> AKS KÖRÜĞÜ +KELEPÇE+YAĞ. DIŞ	Ağırlık : 0.16 kg / 0.353 lb	1H0407285B
	<b>AU15001</b> AMORTİSÖR KÖRÜĞÜ ÖN	Şasi (Ön / Arka) : ÖN Ağırlık : 0,110 kg / 0.243 lb	6N0413175A

**e-Mii**
**I**
**2020 -**

Resim	Ürün Kodu ve Açıklaması	Detay	OEM
	<b>SK1025</b> ROTİL SAĞ	Ağırlık : 0,59 kg / 1.301 lb Konik Ölçüsü : Ø15 Bağlantı Delik Çapı : Ø10,5 Aşık Dış Çapı : M12X1,5	5U0407366A, 6R0407366 6R0407366A, 6R0407366B
	<b>SK1026</b> ROTİL ÖN ALT SOL Ø15	Ağırlık : 0,59 kg / 1.301 lb Konik Ölçüsü : Ø15 Bağlantı Delik Çapı : Ø10,5 Aşık Dış Çapı : M12X1,5	5U0407365A, 6R0407365 6R0407365A, 6R0407365B

\* Bu sayfada ve katalogdaki tüm araçların adları, markaları, modelleri, sembolleri, logoları, orjinal numaraları (oe) ve diğer üçüncü parti numaraları sadece referans amaçlı kullanılmaktadır.

**e-Mii**
**I**
**2020 -**

Resim	Ürün Kodu ve Açıklaması	Detay	OEM
	<b>VW2024</b> ROTBAŞI SAĞ 94 MM	Ağırlık : 0,435 kg / 0.959 lb Uzunluk : 93,5 mm / 3.68 inch Gövde Diş Çapı : M14X1,5 Aşık Diş Çapı : M12X1,5 Aşık Konik Çapı : Ø13,4	1S0423812A
	<b>VW2025</b> ROTBAŞI SOL 94 MM	Ağırlık : 0,435 kg / 0.959 lb Uzunluk : 93,5 mm / 3.68 inch Gövde Diş Çapı : M14X1,5 Aşık Diş Çapı : M12X1,5 Aşık Konik Çapı : Ø13,4	1S0423811A
	<b>VW3020</b> ROTMİLİ SAĞ-SOL <<ÖZELLİK>> 306MM	Ağırlık : 0,576 kg / 1.270 lb Uzunluk : 306 mm / 12.05 inch Gövde Diş Çapı : M14X1,5 Aşık Diş Çapı : M14X1,5	1S0423810A
	<b>VW20243020</b> ROT TAKIMI ÖN SAĞ	Ağırlık : 1,1 kg / 2.425 lb Rotbaşı : VW2024 Rotmilî : VW3020	1S0423810A S1, 1S0423810A
	<b>VW20253020</b> ROT TAKIMI ÖN SOL	Ağırlık : 1,1 kg / 2.425 lb Rotbaşı : VW2024 Rotmilî : VW3020	1S0423810A S2, 1S0423810A
	<b>AU4028</b> Z ROT ÖN	Ağırlık : 0,368 kg / 0.811 lb Malzeme Türü : Metal Uzunluk : 270 mm / 10.63 inch Aşık Diş Çapı : M10X1,5	6Q0411315L, 6Q0411315N 8Z0411315D
	<b>VW6047</b> SALINCAK ÖN SAĞ	Ağırlık : 2,65 kg / 5.842 lb Malzeme Türü : Sac Metal	1S0407152*
	<b>VW6047J</b> SALINCAK ÖN SAĞ	Ağırlık : 2,06 kg / 4.542 lb Malzeme Türü : Sac Metal	1S0407152
	<b>VW6048</b> SALINCAK ÖN SOL	Ağırlık : 2,65 kg / 5.842 lb Malzeme Türü : Sac Metal	1S0407151*
	<b>VW6048J</b> SALINCAK ÖN SOL	Ağırlık : 2,06 kg / 4.542 lb Malzeme Türü : Sac Metal	1S0407151
	<b>AU11002</b> SALINCAK VE DENGİ KOLU BURCU ÖN SOL VE SAĞ B22117	Şasi (Ön / Arka) : ÖN Yön : Sol Ve Sağ Ağırlık : 0,108 kg / 0.238 lb	1J0407181, 1J0407181A

\* Bu sayfada ve katalogdaki tüm araçların adları, markaları, modelleri, sembolleri, logoları, orijinal numaraları (oe) ve diğer üçüncü parti numaraları sadece referans amaçlı kullanılmaktadır.

**e-Mii**
**I**
**2020 -**

Resim	Ürün Kodu ve Açıklaması	Detay	OEM
	<b>AU11005</b> SALINCAK VE DENGE KOLU BURCU ÖN ORTA SOL VE SAĞ B40115	Şasi (Ön / Arka) : Ön Yön : Orta Sol Ve Sağ Ağırlık : 0,111 kg / 0.245 lb Not : VW6014 - VW60614J	191407182, 357407182 357407182F

**EXEO**
**3R2, 3R5**
**2008 - 2013**

Resim	Ürün Kodu ve Açıklaması	Detay	OEM
	<b>AU2217</b> ROTBAŞI SAĞ-SOL RB2217	Ağırlık : 0,414 kg / 0.913 lb Uzunluk : 155 mm / 6.10 inch Gövde Diş Çapı : M14X1,5 Aşık Diş Çapı : M8X1,25 Aşık Konik Çapı : Ø17,5	4B0419811G, 4D0419811J 4F0419811C, 4F0419811D 4F0498811, 4F0498811A 8E0419811
	<b>AU3011</b> ROTMİLİ SAĞ-SOL 128 RB2831	Ağırlık : 0,46 kg / 1.014 lb Uzunluk : 130 mm / 5.12 inch Gövde Diş Çapı : M16X1,5 Aşık Diş Çapı : M14X1,5	4E0419821A, 4F0419882 8E0419821, 8E0422801B 8E0422821, 8E0422821C 8E0422822
	<b>AU22173011</b> ROT TAKIMI ÖN AKS	Ağırlık : 0,97 kg / 2.138 lb Rotbaşı : AU2217 Rotmilî : AU3011	8E0419801E, 8E0419801N
	<b>AU4014</b> Z ROT ÖN SAĞ ALİMİNYUM 90 RB2926	Ağırlık : 0,334 kg / 0.736 lb Malzeme Türü : Alüminyum Uzunluk : 30 mm / 1.18 inch	8E0411318
	<b>AU4015</b> Z ROT ÖN SOL ALİMİNYUM 90 RB2927	Ağırlık : 0,329 kg / 0.725 lb Malzeme Türü : Alüminyum Uzunluk : 30 mm / 1.18 inch	4D0419801B, 8E0411317
	<b>AU5058</b> SALINCAK ÖN SAĞ ALT	Malzeme Türü : Alüminyum	8E0407694AA, 8E0407694AC 8E0407694AD, 8E0407694AF 8E0407694AJ, 8E0407694AK 8E0407694AL, 8E0407694AM 8E0407694T
	<b>AU5059</b> SALINCAK ÖN SOL ALT	Malzeme Türü : Alüminyum	8E0407693AA, 8E0407693AC 8E0407693AD, 8E0407693AF 8E0407693AJ, 8E0407693AK 8E0407693AL, 8E0407693AM 8E0407693T
	<b>AU5085</b> SALINCAK ÖN ÜST ÖNDEN SAĞ	Ağırlık : 0,515 kg / 1.135 lb Malzeme Türü : Alüminyum	8E0407506P
	<b>AU5086</b> SALINCAK ÖN ÜST ÖNDEN SOL	Ağırlık : 0,515 kg / 1.135 lb Malzeme Türü : Alüminyum	8E0407505P

\* Bu sayfada ve katalogdaki tüm araçların adları, markaları, modelleri, sembolleri, logoları, orjinal numaraları (oe) ve diğer üçüncü parti numaraları sadece referans amaçlı kullanılmaktadır.

**EXEO**
**3R2, 3R5**
**2008 - 2013**

Resim	Ürün Kodu ve Açıklaması	Detay	OEM
	<b>AU5087</b> SALINCAK ÖN ÜST ARKADAN SAĞ	Ağırlık : 248,3 kg / 547.408 lb Malzeme Türü : Alüminyum	8E0407510P
	<b>AU5088</b> SALINCAK ÖN ÜST ARKADAN SOL	Ağırlık : 248,3 kg / 547.408 lb Malzeme Türü : Alüminyum	8E0407509P
	<b>AU9002</b> SALINCAK ARKA	Ağırlık : 1,95 kg / 4.299 lb Malzeme Türü : Sac Metal	8E0501529F, 8E0501529G 8E0501529K, 8E0501529L 8E0501529P
	<b>AU9010</b> SALINCAK ARKA ÜST SAĞ	Ağırlık : 1,47 kg / 3.241 lb Malzeme Türü : Sac Metal	3R0505324, 8E0505324M
	<b>AU9011</b> SALINCAK ARKA ÜST SOL	Ağırlık : 1,47 kg / 3.241 lb Malzeme Türü : Sac Metal	3R0505323, 8E0505323M
	<b>AU11032</b> SALINCAK VE DENGE KOLU BURCU ÖN SOL VE SAĞ	Şasi (Ön / Arka) : ÖN Yön : Sol Ve Sağ Ağırlık : 0,17 kg / 0.375 lb Not : DENGE KOLU BURCU	4D0407183L, 4F0407183A 4F0407183B, 4F0407183E
	<b>AU11036</b> SALINCAK VE DENGE KOLU BURCU ÖN SOL VE SAĞ	Şasi (Ön / Arka) : ÖN Yön : Sol Ve Sağ Ağırlık : 0,25 kg / 0.551 lb Not : DENGE KOLU BURCU	4H0407515, 8D0407515A 8K0407515, 8R0407515
	<b>AU11062</b> SALINCAK VE DENGE KOLU BURCU ARKA ÜST SOL VE SAĞ	Şasi (Ön / Arka) : ARKA Yön : Üst Sol Ve Sağ Ağırlık : 0.17 kg / 0.375 lb	8E0501541J, 8E0501541K 8E0501541Q, 8E0501541S
	<b>AU11022</b> TORSİYON BURCU SOL VE SAĞ	Yön : Sol Ve Sağ Ağırlık : 0.59 kg / 1.301 lb	8E0505145AR
	<b>AU12004</b> VİRAJ DEMİR LASTİĞİ SOL VE SAĞ RUBBER	Şasi (Ön / Arka) : ÖN Yön : Sol Ve Sağ Ağırlık : 0.074 kg / 0.163 lb Malzeme Türü : Rubber Not : INTERNAL DIAMETER=Ø29mm	4D0411327J
	<b>AU12004K</b> VİRAJ DEMİR LASTİĞİ SOL VE SAĞ RUBBER	Şasi (Ön / Arka) : ÖN Yön : Sol Ve Sağ Ağırlık : 0.148 kg / 0.326 lb Malzeme Türü : Rubber	4D0411327J

\* Bu sayfada ve katalogdaki tüm araçların adları, markaları, modelleri, sembolleri, logoları, orjinal numaraları (oe) ve diğer üçüncü parti numaraları sadece referans amaçlı kullanılmaktadır.



**EXEO 3R2, 3R5 2008 - 2013**

Resim	Ürün Kodu ve Açıklaması	Detay	OEM
	<b>FI13013</b> DİREKSİYON KÖRÜĞÜ SAĞ	Ağırlık : 0.1 kg / 0.220 lb	114509823, 4239459 4371156, 7583243

**IBIZA I 021A 1984 - 1993**

Resim	Ürün Kodu ve Açıklaması	Detay	OEM
	<b>FI2039</b> ROTBAŞI SAĞ-SOL RB5319	Ağırlık : 0,338 kg / 0.745 lb Uzunluk : 115 mm / 4.53 inch Gövde Diş Çapı : M12X1,5 Aşık Diş Çapı : M10X1,25 Aşık Konik Çapı : Ø12	5960036, 5960037 5960056, 7669756 SE022162406A
	<b>FI3008</b> ROTMİLİ SAĞ-SOL MANUEL 275 RB5819	Ağırlık : 0,512 kg / 1.129 lb Uzunluk : 275 mm / 10.83 inch Gövde Diş Çapı : M14X1,5 Aşık Diş Çapı : M12X1,5	022162449A, 4410145 5958244, 7633721 SE022162449A, SE022162449S
	<b>SE5001</b> SALINCAK ÖN ALT	Malzeme Türü : Dövme Çelik	21156110A, SE021156110A
	<b>SE5002</b> SALINCAK ÖN	Malzeme Türü : Dövme Çelik	SE021156110B
	<b>SE11801</b> BURÇ ORTA BURÇ KİTİ	Yön : Orta Sol Ve Sağ Ağırlık : 0,055 kg / 0.121 lb	SE13856126
	<b>VW11003</b> SALINCAK VE DENGE KOLU BURCU SOL VE SAĞ B22129	Yön : Sol Ve Sağ Ağırlık : 0,126 kg / 0.278 lb	823407181, 861407181
	<b>FI12206</b> DİREKSİYON TAKOZU ÖN SAĞ	Şasi (Ön / Arka) : ÖN Yön : Sağ Diğer Taraf : FI12207 Ağırlık : 0,048 kg / 0.106 lb	4179802, SE127162124A
	<b>FI12206K</b> DİREKSİYON TAKOZU ÖN SAĞ KİT	Şasi (Ön / Arka) : ÖN Yön : Sağ Diğer Taraf : FI12207K Ağırlık : 0,096 kg / 0.212 lb Not : KİT	4179802, SE127162124A
	<b>FI12207</b> DİREKSİYON TAKOZU ÖN SOL	Şasi (Ön / Arka) : ÖN Yön : Sol Diğer Taraf : FI12206 Ağırlık : 0,045 kg / 0.099 lb	4169380, SE127162122A

\* Bu sayfada ve katalogdaki tüm araçların adları, markaları, modelleri, sembolleri, logoları, orjinal numaraları (oe) ve diğer üçüncü parti numaraları sadece referans amaçlı kullanılmaktadır.

**IBIZA I 021A 1984 - 1993**





Resim	Ürün Kodu ve Açıklaması	Detay	OEM
	<b>FI12207K</b> DİREKSİYON TAKOZU ÖN SOL KİT	Şasi (Ön / Arka) : ÖN Yön : Sol Diğer Taraf : FI12206K Ağırlık : 0,090 kg / 0.198 lb Not : KİT	4169380, SE127162122A
	<b>FI13014</b> DİREKSİYON KÖRÜĞÜ SOL	Ağırlık : 0.062 kg / 0.137 lb	114509823, 4239459 4371156, 7583243 9939039

**IBIZA II 1994 - 1999**

Resim	Ürün Kodu ve Açıklaması	Detay	OEM
	<b>FI2039</b> ROTBAŞI SAĞ-SOL RB5319	Ağırlık : 0,338 kg / 0.745 lb Uzunluk : 115 mm / 4.53 inch Gövde Diş Çapı : M12X1,5 Aşık Diş Çapı : M10X1,25 Aşık Konik Çapı : Ø12	5960036, 5960037 5960056, 7669756 SE022162406A
	<b>FI3008</b> ROTMİLİ SAĞ-SOL MANUEL 275 RB5819	Ağırlık : 0,512 kg / 1.129 lb Uzunluk : 275 mm / 10.83 inch Gövde Diş Çapı : M14X1,5 Aşık Diş Çapı : M12X1,5	022162449A, 4410145 5958244, 7633721 SE022162449A, SE022162449S
	<b>SE5001</b> SALINCAK ÖN ALT	Malzeme Türü : Dövme Çelik	21156110A, SE021156110A
	<b>SE5002</b> SALINCAK ÖN	Malzeme Türü : Dövme Çelik	SE021156110B
	<b>SE11801</b> BURÇ ORTA BURÇ KİTİ	Yön : Orta Sol Ve Sağ Ağırlık : 0,055 kg / 0.121 lb	SE13856126
	<b>VW11003</b> SALINCAK VE DENGE KOLU BURCU SOL VE SAĞ B22129	Yön : Sol Ve Sağ Ağırlık : 0,126 kg / 0.278 lb	823407181, 861407181
	<b>VW12060</b> TORSİYON BURCU SOL VE SAĞ	Yön : Sol Ve Sağ Ağırlık : 0,459 kg / 1.012 lb	191501541
	<b>VW12037</b> VİRAJ DEMİR LASTİĞİ SOL VE SAĞ RUBBER	Şasi (Ön / Arka) : ÖN Yön : Sol Ve Sağ Ağırlık : 0.11 kg / 0.243 lb Malzeme Türü : Rubber Not : VİRAJ DEMİR LASTİĞİ ÖN	191411314

\* Bu sayfada ve katalogdaki tüm araçların adları, markaları, modelleri, sembolleri, logoları, orjinal numaraları (oe) ve diğer üçüncü parti numaraları sadece referans amaçlı kullanılmaktadır.

**IBIZA**
**II**
**1994 - 1999**



Resim	Ürün Kodu ve Açıklaması	Detay	OEM
	<b>VW12037K</b> VİRAJ DEMİR LASTİĞİ SOL VE SAĞ RUBBER	Şasi (Ön / Arka) : ÖN Yön : Sol Ve Sağ Ağırlık : 0.22 kg / 0.485 lb Malzeme Türü : Rubber	191411314*
	<b>VW12111</b> VİRAJ DEMİR LASTİĞİ SOL VE SAĞ RUBBER	Şasi (Ön / Arka) : ÖN Yön : Sol Ve Sağ Ağırlık : 0.015 kg / 0.033 lb Malzeme Türü : Rubber Not : VİRAJ LASTİĞİ	191411329, 6N0411329
	<b>VW12111K</b> VİRAJ DEMİR LASTİĞİ SOL VE SAĞ RUBBER	Şasi (Ön / Arka) : ÖN Yön : Sol Ve Sağ Ağırlık : 0.03 kg / 0.066 lb Malzeme Türü : Rubber	191411329*, 6N0411329*
	<b>VW12005</b> AMORTİSÖR TAKOZU SOL VE SAĞ AMORTİSÖR ÜST TAKOZU	Yön : Sol Ve Sağ Ağırlık : 0.1 kg / 0.220 lb Not : AMORTİSÖR ÜST TAKOZU	191512333
	<b>VW12006</b> AMORTİSÖR TAKOZU SOL VE SAĞ AMORTİSÖR ÜST TAKOZU	Yön : Sol Ve Sağ Ağırlık : 0.445 kg / 0.981 lb Not : AMORTİSÖR ÜST TAKOZU	357412331A, 7201848 7M0412331, 95VW3K031AA
	<b>VW12115</b> AMORTİSÖR TAKOZU SOL VE SAĞ AMORTİSÖR TAKOZU	Yön : Sol Ve Sağ Ağırlık : 0.85 kg / 1.874 lb Not : AMORTİSÖR TAKOZU	6N0412331D, 6N0412331E 6Q0412331B
	<b>VW12801</b> AMORTİSÖR TAKOZU SOL VE SAĞ KIT = VW12115 AND VW12109	Yön : Sol Ve Sağ Ağırlık : 1.269 kg / 2.798 lb Not : KIT = VW12115 and VW12109	6N0412249C, 6N0412249E 6N0412331D, 6N0412331E 6Q0412331B
	<b>VW12008</b> MOTOR TAKOZU SOL VE SAĞ MOTOR TAKOZU	Yön : Sol Ve Sağ Ağırlık : 0.574 kg / 1.265 lb Not : MOTOR TAKOZU	357199381C, 357199402B 3A0199402
	<b>VW12074</b> MOTOR TAKOZU SOL VE SAĞ MOTOR TAKOZU	Yön : Sol Ve Sağ Ağırlık : 1.08 kg / 2.381 lb Not : MOTOR TAKOZU	1H0199609B, 1H0199609F 1H0199609G, 1H0199609J
	<b>VW12092</b> MOTOR TAKOZU SAĞ MOTOR TAKOZU ARKA SAĞ	Yön : Sağ Ağırlık : 1,745 kg / 3.847 lb Not : MOTOR TAKOZU ARKA SAĞ	1H0199262B, 1H0199262G 1H0199262H
	<b>VW12098</b> MOTOR TAKOZU SOL VE SAĞ MOTOR TAKOZU	Yön : Sol Ve Sağ Ağırlık : 1,565 kg / 3.450 lb Not : MOTOR TAKOZU	1H0199262E

\* Bu sayfada ve katalogdaki tüm araçların adları, markaları, modelleri, sembolleri, logoları, orjinal numaraları (oe) ve diğer üçüncü parti numaraları sadece referans amaçlı kullanılmaktadır.

**IBIZA**
**II**
**1994 - 1999**











Resim	Ürün Kodu ve Açıklaması	Detay	OEM
	<b>VW12135</b> EGZOZ TAKOZU	Ağırlık : 0,155 kg / 0.342 lb	1H0253144, 1H0253144A 1H0253144C, 1H0253409C 6N0253144
	<b>VW13008</b> DİREKSİYON KÖRÜĞÜ	Ağırlık : 0.225 kg / 0.496 lb	1H0422831B
	<b>RN14006</b> AKS KÖRÜĞÜ +KELEPÇE+YAĞ. DIŞ	Ağırlık : 0.2 kg / 0.441 lb	1603180, 1603204 16410170470106*, 16500170470106* 1H0498203, 271648 271649, 321498203A 431498203C, 443498203D
	<b>VW14013</b> AKS KÖRÜĞÜ +KELEPÇE+YAĞ. YAĞ+KELEPÇE	Ağırlık : 0.156 kg / 0.344 lb	113501149, 171407283A
	<b>VW14014</b> AKS KÖRÜĞÜ +KELEPÇE+YAĞ. YAĞ+KELEPÇE	Ağırlık : 0.28 kg / 0.617 lb	191498203C, 71498203

**IBIZA**
**III 6K1**
**1999 - 2002**

Resim	Ürün Kodu ve Açıklaması	Detay	OEM
	<b>VW1012</b> ROTİL ALT SOL VE SAĞ	Ağırlık : 0,353 kg / 0.778 lb Bağlantı Delik Çapı : Ø8,5	357407365, 357407365A
	<b>VW1012K</b> ROTİL ALT SAĞ-SOL 19 RD0515	Ağırlık : 0,445 kg / 0.981 lb Bağlantı Delik Çapı : Ø8,5	357407365, 357407365A* 357407365A, 357407365S 357407365-S1
	<b>VW1013</b> ROTİL ÖN ALT Ø16,5 RD0519	Ağırlık : 0,415 kg / 0.915 lb Konik Ölçüsü : Ø16,5 Bağlantı Delik Çapı : Ø8,5 Aşık Diş Çapı : M12X1,5	1H0407365
	<b>VW1013K</b> ROTİL	Ağırlık : 0,495 kg / 1.091 lb Konik Ölçüsü : Ø16,5 Bağlantı Delik Çapı : Ø8,5 Aşık Diş Çapı : M12X1,5	1H0407365*, 1H0407365
	<b>VW2006</b> ROTBAŞI SAĞ RD0312	Ağırlık : 0,3 kg / 0.661 lb Uzunluk : 76 mm / 2.99 inch Gövde Diş Çapı : M14X1,5 Aşık Diş Çapı : M12X1,5 Aşık Konik Çapı : Ø12,7	191419812, 22190091617 6N0419812, 6N0422812 XA2087











\* Bu sayfada ve katalogdaki tüm araçların adları, markaları, modelleri, sembolleri, logoları, orijinal numaraları (oe) ve diğer üçüncü parti numaraları sadece referans amaçlı kullanılmaktadır.

**IBIZA**
**III 6K1**
**1999 - 2002**

Resim	Ürün Kodu ve Açıklaması	Detay	OEM
	<b>VW2007</b> ROTBAŞI SOL RD0311	Ağırlık : 0,3 kg / 0.661 lb Uzunluk : 76 mm / 2.99 inch Gövde Diş Çapı : M14X1,5 Aşık Diş Çapı : M12X1,5 Aşık Konik Çapı : Ø12,7	191419811, 22190090617 6N0419811, 6N0422811 XA2084
	<b>VW3003</b> ROTMİLİ SAĞ-SOL RD0817	Ağırlık : 0,678 kg / 1.495 lb Uzunluk : 340 mm / 13.39 inch Gövde Diş Çapı : M22X1,5 Aşık Diş Çapı : M14X1,5	191419721, 191419803 191419803-PART, 191419804* 191419804, 191419807A 191419821
	<b>VW3004</b> ROTMİLİ ÖN SAĞ - SOL 338 RD0887	Ağırlık : 0,605 kg / 1.334 lb Uzunluk : 338 mm / 13.31 inch Gövde Diş Çapı : M14X1,5 Aşık Diş Çapı : M14X1,5	191407153, 191422721 191422803A, 191422804A 191422807, 191422807A 191422821, 191422821A 6K0422821
	<b>VW20063003</b> ROT TAKIMI SAĞ RD088116	Ağırlık : 0,984 kg / 2.169 lb Rotbaşı : VW2006 Rotmilî : VW3003	191419804, 191419804A
	<b>VW20063004</b> ROT TAKIMI ÖN AKS SAĞ	Ağırlık : 0,991 kg / 2.185 lb Rotbaşı : VW2006 Rotmilî : VW3004	191422804A
	<b>VW20073003</b> ROT TAKIMI SOL RD088115	Ağırlık : 0,978 kg / 2.156 lb Rotbaşı : VW2007 Rotmilî : VW3003	191419803, 191419803A
	<b>VW20073004</b> ROT TAKIMI SOL RD088118	Ağırlık : 0,991 kg / 2.185 lb Rotbaşı : VW2007 Rotmilî : VW3004	191422803, 191422803A
	<b>VW4004</b> Z ROT ÖN SAĞ - SOL KOMPLE RD0942	Ağırlık : 0,189 kg / 0.417 lb Malzeme Türü : Komple Uzunluk : 75 mm / 2.95 inch	191411315, 191411315B 191411315BKIT, 191411315BS
	<b>VW4008</b> Z ROT ÖN SAĞ - SOL METAL RD0923	Ağırlık : 0,166 kg / 0.366 lb Malzeme Türü : Metal Uzunluk : 77 mm / 3.03 inch Aşık Diş Çapı : M8X1,25	191411315A, 191411315B 191411315BK
	<b>VW6004J</b> SALINCAK ÖN RD1103	Ağırlık : 2,605 kg / 5.743 lb Malzeme Türü : Sac Metal	191.407.151B, 191407151A 191407151B
	<b>VW6006</b> SALINCAK ÖN SAĞ RD1019	Ağırlık : 3,166 kg / 6.980 lb Malzeme Türü : Sac Metal	191407151B, 191407175 191411315B, 191411331 357407365A, 6N0411329 N0111849, N10127702

\* Bu sayfada ve katalogdaki tüm araçların adları, markaları, modelleri, sembolleri, logoları, orjinal numaraları (oe) ve diğer üçüncü parti numaraları sadece referans amaçlı kullanılmaktadır.

**IBIZA**
**III 6K1**
**1999 - 2002**

Resim	Ürün Kodu ve Açıklaması	Detay	OEM
	<b>VW60066007K</b> SALINCAK ÖN	Ağırlık : 3.3 kg / 7.275 lb Malzeme Türü : Sac Metal	
	<b>VW600674008K</b> SALINCAK ÖN	Ağırlık : 3.466 kg / 7.641 lb Malzeme Türü : Sac Metal	
	<b>VW6007</b> SALINCAK ÖN SOL RD1029	Ağırlık : 3,088 kg / 6.808 lb Malzeme Türü : Sac Metal	191407151A
	<b>VW6014</b> SALINCAK ÖN SAĞ RD1021	Ağırlık : 3,966 kg / 8.744 lb Malzeme Türü : Sac Metal	1H0407152*
	<b>VW6014J</b> SALINCAK ÖN SAĞ RD1106	Ağırlık : 3,35 kg / 7.385 lb Malzeme Türü : Sac Metal	1H0407152
	<b>VW6015</b> SALINCAK ÖN SOL RD1022	Ağırlık : 3,674 kg / 8.100 lb Malzeme Türü : Sac Metal	1H0407151A *, 1H0407151A*
	<b>VW6015J</b> SALINCAK ÖN SOL RD1105	Ağırlık : 3,152 kg / 6.949 lb Malzeme Türü : Sac Metal	1H0.407.151A, 1H0407151 1H0407151A
	<b>AU11005</b> SALINCAK VE DENGE KOLU BURCU ÖN ORTA SOL VE SAĞ B40115	Şasi (Ön / Arka) : ÖN Yön : Orta Sol Ve Sağ Ağırlık : 0,111 kg / 0.245 lb Not : VW6014 - VW60614J	191407182, 357407182 357407182F
	<b>VW11001</b> SALINCAK VE DENGE KOLU BURCU SOL VE SAĞ B40114	Yön : Sol Ve Sağ Ağırlık : 0.141 kg / 0.311 lb	191407181D, 191407181E 357407181
	<b>VW11036</b> SALINCAK VE DENGE KOLU BURCU SOL VE SAĞ	Yön : Sol Ve Sağ Ağırlık : 0.07 kg / 0.154 lb Not : BORUSU	191411315B, 4A0399413A
	<b>VW11840</b> BURÇ	Yön : Sol Ve Sağ Ağırlık : 0,149 kg / 0.328 lb	357407181











\* Bu sayfada ve katalogdaki tüm araçların adları, markaları, modelleri, sembolleri, logoları, orjinal numaraları (oe) ve diğer üçüncü parti numaraları sadece referans amaçlı kullanılmaktadır.

**IBIZA**
**III 6K1**
**1999 - 2002**

Resim	Ürün Kodu ve Açıklaması	Detay	OEM
	<b>VW12068</b> TORSİYON BURCU ARKA SOL VE SAĞ	Şasi (Ön / Arka) : ARKA Yön : Sol Ve Sağ Ağırlık : 0.166 kg / 0.366 lb	6N0501541, 6N0501541D
	<b>VW12068K</b> TORSİYON BURCU ARKA SOL VE SAĞ	Şasi (Ön / Arka) : ARKA Yön : Sol Ve Sağ Ağırlık : 0.332 kg / 0.732 lb	6N0501541, 6N0501541D
	<b>VW12111</b> VİRAJ DEMİR LASTİĞİ SOL VE SAĞ RUBBER	Şasi (Ön / Arka) : ÖN Yön : Sol Ve Sağ Ağırlık : 0.015 kg / 0.033 lb Malzeme Türü : Rubber Not : VİRAJ LASTİĞİ	191411329, 6N0411329
	<b>VW12111K</b> VİRAJ DEMİR LASTİĞİ SOL VE SAĞ RUBBER	Şasi (Ön / Arka) : ÖN Yön : Sol Ve Sağ Ağırlık : 0.03 kg / 0.066 lb Malzeme Türü : Rubber	191411329*, 6N0411329*
	<b>SK12002</b> AMORTİSÖR TAKOZU ARKA SOL VE SAĞ 1.2 / 1.4TSI / 1.6TDI / 1.2TDI	Şasi (Ön / Arka) : ARKA Yön : Sol Ve Sağ Ağırlık : 0.305 kg / 0.672 lb Not : 1.2 / 1.4TSI / 1.6TDI / 1.2TDI	1J0513353A, 1J0513353B 1J0513353C, 1J0513353G 6QE513353, 6R0513353 6R0513353B
	<b>VW12001</b> AMORTİSÖR TAKOZU SOL VE SAĞ AMORTİSÖR TAKOZU	Yön : Sol Ve Sağ Ağırlık : 0.644 kg / 1.420 lb Not : AMORTİSÖR TAKOZU	176412329, 191412329 191412331
	<b>VW12005</b> AMORTİSÖR TAKOZU SOL VE SAĞ AMORTİSÖR ÜST TAKOZU	Yön : Sol Ve Sağ Ağırlık : 0.1 kg / 0.220 lb Not : AMORTİSÖR ÜST TAKOZU	191512333
	<b>VW12006</b> AMORTİSÖR TAKOZU SOL VE SAĞ AMORTİSÖR ÜST TAKOZU	Yön : Sol Ve Sağ Ağırlık : 0.445 kg / 0.981 lb Not : AMORTİSÖR ÜST TAKOZU	357412331A, 7201848 7M0412331, 95VW3K031AA
	<b>VW12109</b> AMORTİSÖR TAKOZU SOL VE SAĞ AMORTİSÖR RULMANI	Yön : Sol Ve Sağ Ağırlık : 0.26 kg / 0.573 lb Not : AMORTİSÖR RULMANI	6N0412249C, 6N0412249E
	<b>VW12109K</b> AMORTİSÖR TAKOZU SOL VE SAĞ 2 PCS	Yön : Sol Ve Sağ Ağırlık : 0.52 kg / 1.146 lb Not : 2 PCS	6N0412249C, 6N0412249E
	<b>VW12115</b> AMORTİSÖR TAKOZU SOL VE SAĞ AMORTİSÖR TAKOZU	Yön : Sol Ve Sağ Ağırlık : 0.85 kg / 1.874 lb Not : AMORTİSÖR TAKOZU	6N0412331D, 6N0412331E 6Q0412331B

\* Bu sayfada ve katalogdaki tüm araçların adları, markaları, modelleri, sembolleri, logoları, orijinal numaraları (oe) ve diğer üçüncü parti numaraları sadece referans amaçlı kullanılmaktadır.

**IBIZA**
**III 6K1**
**1999 - 2002**

Resim	Ürün Kodu ve Açıklaması	Detay	OEM
	<b>VW12801</b> AMORTİSÖR TAKOZU SOL VE SAĞ KIT = VW12115 AND VW12109	Yön : Sol Ve Sağ Ağırlık : 1.269 kg / 2.798 lb Not : KIT = VW12115 and VW12109	6N0412249C, 6N0412249E 6N0412331D, 6N0412331E 6Q0412331B
	<b>VW12008</b> MOTOR TAKOZU SOL VE SAĞ MOTOR TAKOZU	Yön : Sol Ve Sağ Ağırlık : 0.574 kg / 1.265 lb Not : MOTOR TAKOZU	357199381C, 357199402B 3A0199402
	<b>VW12074</b> MOTOR TAKOZU SOL VE SAĞ MOTOR TAKOZU	Yön : Sol Ve Sağ Ağırlık : 1.08 kg / 2.381 lb Not : MOTOR TAKOZU	1H0199609B, 1H0199609F 1H0199609G, 1H0199609J
	<b>VW12092</b> MOTOR TAKOZU SAĞ MOTOR TAKOZU ARKA SAĞ	Yön : Sağ Ağırlık : 1,745 kg / 3.847 lb Not : MOTOR TAKOZU ARKA SAĞ	1H0199262B, 1H0199262G 1H0199262H
	<b>VW12098</b> MOTOR TAKOZU SOL VE SAĞ MOTOR TAKOZU	Yön : Sol Ve Sağ Ağırlık : 1,565 kg / 3.450 lb Not : MOTOR TAKOZU	1H0199262E
	<b>VW12089</b> SÜSPANSİYON TAKOZU SOL VE SAĞ SÜSPANSİYON TAKOZU	Yön : Sol Ve Sağ Ağırlık : 0.15 kg / 0.331 lb Not : SÜSPANSİYON TAKOZU	191412303A, 357412303E
	<b>VW12135</b> EGZOZ TAKOZU	Ağırlık : 0,155 kg / 0.342 lb	1H0253144, 1H0253144A 1H0253144C, 1H0253409C 6N0253144
	<b>VW13008</b> DİREKSİYON KÖRÜĞÜ	Ağırlık : 0.225 kg / 0.496 lb	1H0422831B
	<b>VW13010</b> DİREKSİYON KÖRÜĞÜ ÖN	Ağırlık : 0,124 kg / 0.273 lb	191422831
	<b>OP14003</b> AKS KÖRÜĞÜ +KELEPÇE+YAĞ. AKS KÖRÜĞÜ DIŞ	Ağırlık : 0.2 kg / 0.441 lb	1603180
	<b>RN14006</b> AKS KÖRÜĞÜ +KELEPÇE+YAĞ. DIŞ	Ağırlık : 0.2 kg / 0.441 lb	1603180, 1603204 16410170470106*, 16500170470106* 1H0498203, 271648 271649, 321498203A 431498203C, 443498203D

\* Bu sayfada ve katalogdaki tüm araçların adları, markaları, modelleri, sembolleri, logoları, orijinal numaraları (oe) ve diğer üçüncü parti numaraları sadece referans amaçlı kullanılmaktadır.



**IBIZA**
**III 6K1**
**1999 - 2002**







Resim	Ürün Kodu ve Açıklaması	Detay	OEM
	<b>VW14013</b> AKS KÖRÜĞÜ +KELEPÇE+YAĞ. YAĞ+KELEPÇE	Ağırlık : 0.156 kg / 0.344 lb	113501149, 171407283A
	<b>AU15001</b> AMORTİSÖR KÖRÜĞÜ ÖN	Şasi (Ön / Arka) : ÖN Ağırlık : 0,110 kg / 0.243 lb	6N0413175A

**IBIZA**
**IV 6L1**
**2002 - 2009**

Resim	Ürün Kodu ve Açıklaması	Detay	OEM
	<b>SK1023</b> ROTİL SAĞ RD0530	Ağırlık : 0,46 kg / 1.014 lb Konik Ölçüsü : Ø15 Bağlantı Delik Çapı : Ø8,5 Aşık Diş Çapı : M12X1,5	6Q0407366A, 6Q0407366B 6Q0407366E, 6Q0407366M 8Z0407366A
	<b>SK1023K</b> ROTİL ÖN ALT SAĞ Ø15 KIT	Ağırlık : 0,5 kg / 1.102 lb Konik Ölçüsü : Ø15 Bağlantı Delik Çapı : Ø8,5 Aşık Diş Çapı : M12X1,5	6Q0407366A*, 6Q0407366A 6Q0407366B*, 6Q0407366E* 6Q0407366M*, 6Q0407366M 8Z0407366A*
	<b>SK1024</b> ROTİL SOL RD0531	Ağırlık : 0,46 kg / 1.014 lb Konik Ölçüsü : Ø15 Bağlantı Delik Çapı : Ø8,5 Aşık Diş Çapı : M12X1,5	6Q0407365A, 6Q0407365B 6Q0407365E, 6Q0407365M 8Z0407365A
	<b>SK1024K</b> ROTİL SOL	Ağırlık : 0,5 kg / 1.102 lb Konik Ölçüsü : Ø15 Bağlantı Delik Çapı : Ø8,5 Aşık Diş Çapı : M12X1,5	6Q0407365A*, 6Q0407365A 6Q0407365B*, 6Q0407365E* 6Q0407365E, 6Q0407365M* 6Q0407365M, 8Z0407365A*
	<b>SE2001</b> ROTBAŞI SAĞ	Ağırlık : 0,387 kg / 0.853 lb Uzunluk : 92 mm / 3.62 inch Gövde Diş Çapı : M14X1,5 Aşık Diş Çapı : M12X1,5 Aşık Konik Çapı : Ø12,6	6Q0423812C
	<b>SE2002</b> ROTBAŞI SOL	Ağırlık : 0,377 kg / 0.831 lb Uzunluk : 92 mm / 3.62 inch Gövde Diş Çapı : M14X1,5 Aşık Diş Çapı : M12X1,5 Aşık Konik Çapı : Ø12,6	6Q0423811C
	<b>SK2003</b> ROTBAŞI SAĞ RC7314	Ağırlık : 0,377 kg / 0.831 lb Uzunluk : 93,5 mm / 3.68 inch Gövde Diş Çapı : M14X1,5 Aşık Diş Çapı : M12X1,5 Aşık Konik Çapı : Ø13,5	5Z0423812, 6Q0419812C 6Q0423812, 6Q0423812A 6Q0423812C, 6Q0423812D 6R0423812, 8Z0423811A
	<b>SK2004</b> ROTBAŞI SOL RC7313	Ağırlık : 0,382 kg / 0.842 lb Uzunluk : 93 mm / 3.66 inch Gövde Diş Çapı : M14X1,5 Aşık Diş Çapı : M12X1,5 Aşık Konik Çapı : Ø13,5	5Z0423811, 6Q0419811C 6Q0423811, 6Q0423811A 6Q0423811C, 6Q0423811D 6R0423811, 8Z0423812A

\* Bu sayfada ve katalogdaki tüm araçların adları, markaları, modelleri, sembolleri, logoları, orjinal numaraları (oe) ve diğer üçüncü parti numaraları sadece referans amaçlı kullanılmaktadır.

**IBIZA**
**IV 6L1**
**2002 - 2009**

Resim	Ürün Kodu ve Açıklaması	Detay	OEM
	<b>SE3001</b> ROTMİLİ	Ağırlık : 0,63 kg / 1.389 lb Uzunluk : 320 mm / 12.60 inch Gövde Diş Çapı : M14X1,5 Aşık Diş Çapı : M14X1,5	6Q0423803E*, 6Q0423804E* 6Q0423810E*, 6Q0423810P*
	<b>SK3003</b> ROTMİLİ SAĞ-SOL 297	Ağırlık : 0,552 kg / 1.217 lb Uzunluk : 297 mm / 11.69 inch Gövde Diş Çapı : M14X1,5 Aşık Diş Çapı : M14X1,5	6Q0 423 821 B, 6Q0423821B 6X0422803, 6X0422804 6X0422807, 6X0422821
	<b>SE20013001</b> ROT TAKIMI ÖN AKS SAĞ	Ağırlık : 0,998 kg / 2.200 lb Rotbaşı : SE2001 Rotmilî : SE3001	6K0422804E
	<b>SE20023001</b> ROT TAKIMI ÖN AKS SOL	Ağırlık : 0,995 kg / 2.194 lb Rotbaşı : SE2002 Rotmilî : SE3001	6K0422803E
	<b>SK20033003</b> ROT TAKIMI ÖN AKS SAĞ RC788115	Ağırlık : 1,021 kg / 2.251 lb Rotbaşı : SK2003 Rotmilî : SK3003	6Q0422804B, 6Q0423804B
	<b>SK20043003</b> ROT TAKIMI SOL RC788114	Ağırlık : 0,932 kg / 2.055 lb Rotbaşı : SK2004 Rotmilî : SK3003	6Q0422803B, 6Q0423803B
	<b>AU4028</b> Z ROT ÖN	Ağırlık : 0,368 kg / 0.811 lb Malzeme Türü : Metal Uzunluk : 270 mm / 10.63 inch Aşık Diş Çapı : M10X1,5	6Q0411315L, 6Q0411315N 8Z0411315D
	<b>SK6009</b> SALINCAK ÖN ALT SAĞ RD1035	Ağırlık : 2,676 kg / 5.900 lb Malzeme Türü : Sac Metal	6N0407151, 6Q0407151D* 6Q0407151D, 6Q0407151E* 6Q0407151E, 6Q0407151L 6Q0407151Z, 6Q0407366A*
	<b>SK6009J</b> SALINCAK ÖN ALT RD10211	Ağırlık : 2,626 kg / 5.789 lb Malzeme Türü : Sac Metal	6Q0407151D, 6Q0407151E 6Q0407151L
	<b>SK6009K</b> SALINCAK ÖN ALT SAĞ	Ağırlık : 3,13 kg / 6.900 lb Malzeme Türü : Sac Metal	6N0407151, 6Q0407151D 6Q0407151E, 6Q0407151L 6Q0407151Z
	<b>SK6010</b> SALINCAK ÖN ALT SOL RD1036	Ağırlık : 3,13 kg / 6.900 lb Malzeme Türü : Sac Metal	6N040711, 6Q0407151D* 6Q0407151D, 6Q0407151E* 6Q0407151E, 6Q0407151L 6Q0407151Z, 6Q0407365A*

\* Bu sayfada ve katalogdaki tüm araçların adları, markaları, modelleri, sembolleri, logoları, orjinal numaraları (oe) ve diğer üçüncü parti numaraları sadece referans amaçlı kullanılmaktadır.

**IBIZA**
**IV 6L1**
**2002 - 2009**

Resim	Ürün Kodu ve Açıklaması	Detay	OEM
	<b>SK6010K</b> SALINCAK ÖN ALT SOL	Ağırlık : 3,13 kg / 6.900 lb Malzeme Türü : Sac Metal	6N040711, 6Q0407151D* 6Q0407151D, 6Q0407151E* 6Q0407151E, 6Q0407151L 6Q0407151Z, 6Q0407365A*
	<b>VW11045</b> SALINCAK VE DENGE KOLU BURCU ORTA SOL VE SAĞ B40128	Yön : Orta Sol Ve Sağ Ağırlık : 0,145 kg / 0.320 lb	6Q0407182A
	<b>VW11047</b> SALINCAK VE DENGE KOLU BURCU İÇ SOL VE SAĞ B37117	Yön : İç Sol Ve Sağ Ağırlık : 0,121 kg / 0.267 lb	1K0199231J, 1K0199231J-P 1K0407183E
	<b>VW11051</b> SALINCAK VE DENGE KOLU BURCU SOL VE SAĞ	Yön : Sol Ve Sağ Ağırlık : 0.121 kg / 0.267 lb	6Q0407183, 6Q0407183A
	<b>VW11055</b> SALINCAK VE DENGE KOLU BURCU İÇ SOL VE SAĞ	Yön : İç Sol Ve Sağ Ağırlık : 0.121 kg / 0.267 lb	1K0407183E, 8J0407183
	<b>VW12010</b> TORSİYON BURCU SOL VE SAĞ	Yön : Sol Ve Sağ Ağırlık : 0.31 kg / 0.683 lb	1J0500045, 1J0500045A 1J0501541B, 1J0501541C 6R0501541A, 6R0501541B
	<b>VW12066</b> TORSİYON BURCU SOL VE SAĞ	Yön : Sol Ve Sağ Ağırlık : 0.6 kg / 1.323 lb	1J0 501 541 D, 1J0501541D
	<b>VW12015</b> VİRAJ DEMİR LASTİĞİ SOL VE SAĞ RUBBER	Şasi (Ön / Arka) : ÖN Yön : Sol Ve Sağ Ağırlık : 0.03 kg / 0.066 lb Malzeme Türü : Rubber Not : VİRAJ DEMİR LASTİĞİ	6Q0411303H, 6Q0411314E 6Q0411314N, 6Q0411314R
	<b>VW12015K</b> VİRAJ DEMİR LASTİĞİ SOL VE SAĞ RUBBER	Şasi (Ön / Arka) : ÖN Yön : Sol Ve Sağ Ağırlık : 0.06 kg / 0.132 lb Malzeme Türü : Rubber Not : VİRAJ LASTİĞİ (İKİLİ)	6Q0411303H*, 6Q0411303H 6Q0411314E*, 6Q0411314E 6Q0411314N*, 6Q0411314N 6Q0411314R*, 6Q0411314R
	<b>VW12024</b> VİRAJ DEMİR LASTİĞİ SOL VE SAĞ RUBBER	Şasi (Ön / Arka) : ÖN Yön : Sol Ve Sağ Ağırlık : 0.03 kg / 0.066 lb Malzeme Türü : Rubber Not : VİRAJ LASTİĞİ	6Q0411303AA, 6Q0411303AD 6Q0411305H, 6Q0411314M 6Q0411314Q
	<b>VW12024K</b> VİRAJ DEMİR LASTİĞİ SOL VE SAĞ RUBBER	Şasi (Ön / Arka) : ÖN Yön : Sol Ve Sağ Ağırlık : 0.06 kg / 0.132 lb Malzeme Türü : Rubber Not : VİRAJ LASTİĞİ (İKİLİ)	6Q0411303AA*, 6Q0411303AA 6Q0411303AD*, 6Q0411303AD 6Q0411305H*, 6Q0411305H 6Q0411314M*, 6Q0411314M 6Q0411314Q*, 6Q0411314Q









\* Bu sayfada ve katalogdaki tüm araçların adları, markaları, modelleri, sembolleri, logoları, orijinal numaraları (oe) ve diğer üçüncü parti numaraları sadece referans amaçlı kullanılmaktadır.

**IBIZA**
**IV 6L1**
**2002 - 2009**

Resim	Ürün Kodu ve Açıklaması	Detay	OEM
	<b>VW12050</b> VİRAJ DEMİR LASTİĞİ SOL VE SAĞ RUBBER	Şasi (Ön / Arka) : ÖN Yön : Sol Ve Sağ Ağırlık : 0.04 kg / 0.088 lb Malzeme Türü : Rubber Not : VİRAJ LASTİĞİ	6Q0411314P
	<b>VW12050K</b> VİRAJ DEMİR LASTİĞİ SOL VE SAĞ RUBBER	Şasi (Ön / Arka) : ÖN Yön : Sol Ve Sağ Ağırlık : 0.08 kg / 0.176 lb Malzeme Türü : Rubber Not : VİRAJ LASTİĞİ (İKİLİ)	6Q0411314P*, 6Q0411314P
	<b>SK12002</b> AMORTİSÖR TAKOZU ARKA SOL VE SAĞ 1.2 / 1.4TSI / 1.6TDI / 1.2TDI	Şasi (Ön / Arka) : ARKA Yön : Sol Ve Sağ Ağırlık : 0.305 kg / 0.672 lb Not : 1.2 / 1.4TSI / 1.6TDI / 1.2TDI	1J0513353A, 1J0513353B 1J0513353C, 1J0513353G 6QE513353, 6R0513353 6R0513353B
	<b>VW12005</b> AMORTİSÖR TAKOZU SOL VE SAĞ AMORTİSÖR ÜST TAKOZU	Yön : Sol Ve Sağ Ağırlık : 0.1 kg / 0.220 lb Not : AMORTİSÖR ÜST TAKOZU	191512333
	<b>VW12109</b> AMORTİSÖR TAKOZU SOL VE SAĞ AMORTİSÖR RULMANI	Yön : Sol Ve Sağ Ağırlık : 0.26 kg / 0.573 lb Not : AMORTİSÖR RULMANI	6N0412249C, 6N0412249E
	<b>VW12109K</b> AMORTİSÖR TAKOZU SOL VE SAĞ 2 PCS	Yön : Sol Ve Sağ Ağırlık : 0.52 kg / 1.146 lb Not : 2 PCS	6N0412249C, 6N0412249E
	<b>VW12115</b> AMORTİSÖR TAKOZU SOL VE SAĞ AMORTİSÖR TAKOZU	Yön : Sol Ve Sağ Ağırlık : 0.85 kg / 1.874 lb Not : AMORTİSÖR TAKOZU	6N0412331D, 6N0412331E 6Q0412331B
	<b>VW12801</b> AMORTİSÖR TAKOZU SOL VE SAĞ KIT = VW12115 AND VW12109	Yön : Sol Ve Sağ Ağırlık : 1.269 kg / 2.798 lb Not : KIT = VW12115 and VW12109	6N0412249C, 6N0412249E 6N0412331D, 6N0412331E 6Q0412331B
	<b>SE12001</b> MOTOR TAKOZU ÖN SOL VE SAĞ	Şasi (Ön / Arka) : ÖN Yön : Sol Ve Sağ Ağırlık : 1,360 kg / 2.998 lb	6C0199851J
	<b>SE12002</b> MOTOR TAKOZU ÖN SOL VE SAĞ	Şasi (Ön / Arka) : ÖN Yön : Sol Ve Sağ Ağırlık : 1,100 kg / 2.425 lb	6C0199851
	<b>SE12003</b> MOTOR TAKOZU ÖN SOL VE SAĞ	Şasi (Ön / Arka) : ÖN Yön : Sol Ve Sağ Ağırlık : 1,900 kg / 4.189 lb	6C0199167B

\* Bu sayfada ve katalogdaki tüm araçların adları, markaları, modelleri, sembolleri, logoları, orijinal numaraları (oe) ve diğer üçüncü parti numaraları sadece referans amaçlı kullanılmaktadır.

**IBIZA**
**IV 6L1**
**2002 - 2009**

Resim	Ürün Kodu ve Açıklaması	Detay	OEM
	<b>SE12004</b> MOTOR TAKOZU ÖN SOL VE SAĞ	Şasi (Ön / Arka) : ÖN Yön : Sol Ve Sağ Ağırlık : 1,300 kg / 2.866 lb	6C0199262A
	<b>SE12005</b> MOTOR TAKOZU ARKA	Şasi (Ön / Arka) : ARKA Ağırlık : 1,115 kg / 2.458 lb	6Q0199851AS, 6Q0199851T
	<b>VW12028</b> MOTOR TAKOZU SOL VE SAĞ MOTOR TAKOZU	Yön : Sol Ve Sağ Ağırlık : 1.1 kg / 2.425 lb Not : MOTOR TAKOZU	6Q0199851, 6Q0199851AK
	<b>VW12069</b> MOTOR TAKOZU SOL VE SAĞ MOTOR TAKOZU	Yön : Sol Ve Sağ Ağırlık : 0.83 kg / 1.830 lb Not : MOTOR TAKOZU	6Q0199851AB, 6Q0199851AK
	<b>VW12080</b> MOTOR TAKOZU SOL VE SAĞ MOTOR TAKOZU	Yön : Sol Ve Sağ Ağırlık : 2.02 kg / 4.453 lb Not : MOTOR TAKOZU	6Q0199167AQ, 6Q0199167BM 6Q0199167BQ, 6Q0199167BR 6Q0199167CA, 6Q0199167CB 6Q0199167CC, 6Q0199167CE 6Q0199167CJ, 6Q0199167CR
	<b>VW12083</b> MOTOR TAKOZU SOL VE SAĞ MOTOR TAKOZU	Yön : Sol Ve Sağ Ağırlık : 1.95 kg / 4.299 lb Not : MOTOR TAKOZU	6Q0199167BC, 6Q0199167BN 6Q0199167CH, 6Q0199167CL 6Q0199167DA, 6Q0199167DB 6Q0199167DL, 6Q0199167DM 6R0199167AA
	<b>VW12093</b> MOTOR TAKOZU SOL VE SAĞ MOTOR TAKOZU	Yön : Sol Ve Sağ Ağırlık : 1.05 kg / 2.315 lb Not : MOTOR TAKOZU	6Q0199851AC, 6Q0199851AL 6Q0199851AR, 6Q0199851E 6Q0199851S
	<b>VW12123</b> MOTOR TAKOZU SOL ŞANZUMAN TAKOZU	Yön : Sol Ağırlık : 1.642 kg / 3.620 lb Malzeme Türü : Şanzuman Takozu	6Q0199555AE, 6Q0199555AT 6R0199555, 6RF199555A 6RF199555C
	<b>VW12036</b> SÜSPANSİYON TAKOZU SOL VE SAĞ ARKA SUSPANSİYON TAKOZU	Yön : Sol Ve Sağ Ağırlık : 1.591 kg / 3.508 lb Not : ARKA SUSPANSİYON TAKOZU	6Q0512131B
	<b>SK12006</b> EGZOZ TAKOZU	Ağırlık : 0,185 kg / 0.408 lb	6Q0253144B, 6Q0253144D
	<b>AU14001</b> AKS KÖRÜĞÜ +KELEPÇE+YAĞ.	Ağırlık : 0.233 kg / 0.514 lb	6Q0498203A

\* Bu sayfada ve katalogdaki tüm araçların adları, markaları, modelleri, sembolleri, logoları, orjinal numaraları (oe) ve diğer üçüncü parti numaraları sadece referans amaçlı kullanılmaktadır.

**IBIZA**
**IV 6L1**
**2002 - 2009**

Resim	Ürün Kodu ve Açıklaması	Detay	OEM
	<b>F114014</b> AKS KÖRÜĞÜ +KELEPÇE+YAĞ. DIŞ	Ağırlık : 0.211 kg / 0.465 lb	46307841
	<b>VW14003</b> AKS KÖRÜĞÜ +KELEPÇE+YAĞ. DIŞ	Ağırlık : 0.25 kg / 0.551 lb	1K0 498 203, 1K0498203
	<b>VW14009</b> AKS KÖRÜĞÜ +KELEPÇE+YAĞ. DIŞ	Ağırlık : 0.16 kg / 0.353 lb	1H0407285B
	<b>AU15001</b> AMORTİSÖR KÖRÜĞÜ ÖN	Şasi (Ön / Arka) : ÖN Ağırlık : 0,110 kg / 0.243 lb	6N0413175A

**IBIZA**
**V 6J**
**2009 - 2017**

Resim	Ürün Kodu ve Açıklaması	Detay	OEM
	<b>SK1025</b> ROTİL SAĞ	Ağırlık : 0,59 kg / 1.301 lb Konik Ölçüsü : Ø15 Bağlantı Delik Çapı : Ø10,5 Aşık Diş Çapı : M12X1,5	5U0407366A, 6R0407366 6R0407366A, 6R0407366B
	<b>SK1026</b> ROTİL ÖN ALT SOL Ø15	Ağırlık : 0,59 kg / 1.301 lb Konik Ölçüsü : Ø15 Bağlantı Delik Çapı : Ø10,5 Aşık Diş Çapı : M12X1,5	5U0407365A, 6R0407365 6R0407365A, 6R0407365B
	<b>SK2003</b> ROTBAŞI SAĞ RC7314	Ağırlık : 0,377 kg / 0.831 lb Uzunluk : 93,5 mm / 3.68 inch Gövde Diş Çapı : M14X1,5 Aşık Diş Çapı : M12X1,5 Aşık Konik Çapı : Ø13,5	5Z0423812, 6Q0419812C 6Q0423812, 6Q0423812A 6Q0423812C, 6Q0423812D 6R0423812, 8Z0423811A
	<b>SK2004</b> ROTBAŞI SOL RC7313	Ağırlık : 0,382 kg / 0.842 lb Uzunluk : 93 mm / 3.66 inch Gövde Diş Çapı : M14X1,5 Aşık Diş Çapı : M12X1,5 Aşık Konik Çapı : Ø13,5	5Z0423811, 6Q0419811C 6Q0423811, 6Q0423811A 6Q0423811C, 6Q0423811D 6R0423811, 8Z0423812A
	<b>SK2006</b> ROTBAŞI SAĞ	Ağırlık : 0,420 kg / 0.926 lb Uzunluk : 94 mm / 3.70 inch Gövde Diş Çapı : M14X1,5 Aşık Diş Çapı : M12X1,5 Aşık Konik Çapı : Ø13,3	6C0423812A
	<b>SK2007</b> ROTBAŞI SOL	Ağırlık : 0,420 kg / 0.926 lb Uzunluk : 94 mm / 3.70 inch Gövde Diş Çapı : M14X1,5 Aşık Diş Çapı : M12X1,5 Aşık Konik Çapı : Ø13,3	6C0423811A

\* Bu sayfada ve katalogdaki tüm araçların adları, markaları, modelleri, sembolleri, logoları, orjinal numaraları (oe) ve diğer üçüncü parti numaraları sadece referans amaçlı kullanılmaktadır.

**IBIZA**
**V 6J**
**2009 - 2017**

Resim	Ürün Kodu ve Açıklaması	Detay	OEM
	<b>VW3017</b> ROTMİLİ ÖN M14X1.5 313	Ağırlık : 0,6 kg / 1.323 lb Uzunluk : 313 mm / 12.32 inch Gövde Diş Çapı : M14X1,5 Aşık Diş Çapı : M14X1,5	6R0423803, 6R0423803C 6R0423804, 6R0423804B 6R0423804C, 6R0423810 8Z0419810C, 8Z0423803
	<b>SK2003VW3017</b> ROT TAKIMI ÖN AKS SAĞ	Ağırlık : 1,008 kg / 2.222 lb Rotbaşı : SK2003 Rotmili : VW3017	6R0423804, 6R0423804A 8Z0423804C
	<b>SK2004VW3017</b> ROT TAKIMI ÖN AKS SOL	Ağırlık : 1,008 kg / 2.222 lb Rotbaşı : SK2004 Rotmili : VW3017	6R0423803, 6R0423803A 8Z0423803C, SK-402923
	<b>AU4028</b> Z ROT ÖN	Ağırlık : 0,368 kg / 0.811 lb Malzeme Türü : Metal Uzunluk : 270 mm / 10.63 inch Aşık Diş Çapı : M10X1,5	6Q0411315L, 6Q0411315N 8Z0411315D
	<b>SK4001</b> Z ROT ÖN METAL	Ağırlık : 0,357 kg / 0.787 lb Malzeme Türü : Metal Uzunluk : 270 mm / 10.63 inch Aşık Diş Çapı : M10X1,5	2Q0411315, 2Q0411315A 6Q0411315A, 6Q0411315E 6Q0411315F, 6Q0411315H 6Q0411315J, 6Q0411315M 6Q0411315P
	<b>VW6034</b> SALINCAK ÖN SAĞ	Ağırlık : 3,495 kg / 7.705 lb Malzeme Türü : Sac Metal	6R0407152A**, 6R0407152A 6R0407152B**, 6R0407152C** 6R0407152C, 6R0407152E 6R0407152F**
	<b>VW6034J</b> SALINCAK ÖN SAĞ	Ağırlık : 3 kg / 6.614 lb Malzeme Türü : Sac Metal	6R0407152A, 6R0407152B 6R0407152C, 6R0407152F
	<b>VW6035</b> SALINCAK ÖN SOL	Ağırlık : 3,495 kg / 7.705 lb Malzeme Türü : Sac Metal	6R0407151A**, 6R0407151A 6R0407151B**, 6R0407151C** 6R0407151C, 6R0407151E 6R0407151F**
	<b>VW6035J</b> SALINCAK ÖN SOL	Ağırlık : 3,5 kg / 7.716 lb Malzeme Türü : Sac Metal	6R0407151A, 6R0407151B 6R0407151C, 6R0407151F
	<b>AU11002</b> SALINCAK VE DENGE KOLU BURCU ÖN SOL VE SAĞ B22117	Şasi (Ön / Arka) : ÖN Yön : Sol Ve Sağ Ağırlık : 0,108 kg / 0.238 lb	1J0407181, 1J0407181A
	<b>AU11005</b> SALINCAK VE DENGE KOLU BURCU ÖN ORTA SOL VE SAĞ B40115	Şasi (Ön / Arka) : ÖN Yön : Orta Sol Ve Sağ Ağırlık : 0,111 kg / 0.245 lb Not : VW6014 - VW60614J	191407182, 357407182 357407182F

\* Bu sayfada ve katalogdaki tüm araçların adları, markaları, modelleri, sembolleri, logoları, orjinal numaraları (oe) ve diğer üçüncü parti numaraları sadece referans amaçlı kullanılmaktadır.







**IBIZA**
**V 6J**
**2009 - 2017**

Resim	Ürün Kodu ve Açıklaması	Detay	OEM
	<b>VW12010</b> TORSİYON BURCU SOL VE SAĞ	Yön : Sol Ve Sağ Ağırlık : 0.31 kg / 0.683 lb	1J0500045, 1J0500045A 1J0501541B, 1J0501541C 6R0501541A, 6R0501541B
	<b>VW12024</b> VİRAJ DEMİR LASTİĞİ SOL VE SAĞ RUBBER	Şasi (Ön / Arka) : ÖN Yön : Sol Ve Sağ Ağırlık : 0.03 kg / 0.066 lb Malzeme Türü : Rubber Not : VİRAJ LASTİĞİ	6Q0411303AA, 6Q0411303AD 6Q0411305H, 6Q0411314M 6Q0411314Q
	<b>VW12024K</b> VİRAJ DEMİR LASTİĞİ SOL VE SAĞ RUBBER	Şasi (Ön / Arka) : ÖN Yön : Sol Ve Sağ Ağırlık : 0.06 kg / 0.132 lb Malzeme Türü : Rubber Not : VİRAJ LASTİĞİ (İKİLİ)	6Q0411303AA*, 6Q0411303AA 6Q0411303AD*, 6Q0411303AD 6Q0411305H*, 6Q0411305H 6Q0411314M*, 6Q0411314M 6Q0411314Q*, 6Q0411314Q
	<b>VW12050</b> VİRAJ DEMİR LASTİĞİ SOL VE SAĞ RUBBER	Şasi (Ön / Arka) : ÖN Yön : Sol Ve Sağ Ağırlık : 0.04 kg / 0.088 lb Malzeme Türü : Rubber Not : VİRAJ LASTİĞİ	6Q0411314P
	<b>VW12050K</b> VİRAJ DEMİR LASTİĞİ SOL VE SAĞ RUBBER	Şasi (Ön / Arka) : ÖN Yön : Sol Ve Sağ Ağırlık : 0.08 kg / 0.176 lb Malzeme Türü : Rubber Not : VİRAJ LASTİĞİ (İKİLİ)	6Q0411314P*, 6Q0411314P
	<b>SK12002</b> AMORTİSÖR TAKOZU ARKA SOL VE SAĞ 1.2 / 1.4TSI / 1.6TDI / 1.2TDI	Şasi (Ön / Arka) : ARKA Yön : Sol Ve Sağ Ağırlık : 0.305 kg / 0.672 lb Not : 1.2 / 1.4TSI / 1.6TDI / 1.2TDI	1J0513353A, 1J0513353B 1J0513353C, 1J0513353G 6QE513353, 6R0513353 6R0513353B
	<b>VW12061</b> AMORTİSÖR TAKOZU SOL VE SAĞ AMORTİSÖR TAKOZU	Yön : Sol Ve Sağ Ağırlık : 0.27 kg / 0.595 lb Not : AMORTİSÖR TAKOZU	1H0412365A, 1J0412249 1J0412331BS, 1J0412331C
	<b>VW12061A</b> AMORTİSÖR TAKOZU SOL VE SAĞ AMORTİSÖR RULMANI	Yön : Sol Ve Sağ Ağırlık : 0.08 kg / 0.176 lb Not : AMORTİSÖR RULMANI	1J0412249, 1J0412249C 357412249, 357412249A 4503300051, 7201688 7201848, 95VW3K031AA
	<b>VW12061K</b> AMORTİSÖR TAKOZU SOL VE SAĞ 2 PCS	Yön : Sol Ve Sağ Ağırlık : 0.7 kg / 1.543 lb Not : 2 PCS	1H0412365A, 1J0412249 1J0412331BS, 1J0412331C
	<b>VW12103</b> AMORTİSÖR TAKOZU SOL VE SAĞ AMORTİSÖR ÜST TAKOZU	Yön : Sol Ve Sağ Ağırlık : 0.23 kg / 0.507 lb Not : AMORTİSÖR ÜST TAKOZU	1J0412331B, 1J0412331C
	<b>SE12001</b> MOTOR TAKOZU ÖN SOL VE SAĞ	Şasi (Ön / Arka) : ÖN Yön : Sol Ve Sağ Ağırlık : 1.360 kg / 2.998 lb	6C0199851J

\* Bu sayfada ve katalogdaki tüm araçların adları, markaları, modelleri, sembolleri, logoları, orijinal numaraları (oe) ve diğer üçüncü parti numaraları sadece referans amaçlı kullanılmaktadır.





**IBIZA**
**V 6J**
**2009 - 2017**

Resim	Ürün Kodu ve Açıklaması	Detay	OEM
	<b>SE12002</b> MOTOR TAKOZU ÖN SOL VE SAĞ	Şasi (Ön / Arka) : ÖN Yön : Sol Ve Sağ Ağırlık : 1,100 kg / 2.425 lb	6C0199851
	<b>SE12003</b> MOTOR TAKOZU ÖN SOL VE SAĞ	Şasi (Ön / Arka) : ÖN Yön : Sol Ve Sağ Ağırlık : 1,900 kg / 4.189 lb	6C0199167B
	<b>SE12004</b> MOTOR TAKOZU ÖN SOL VE SAĞ	Şasi (Ön / Arka) : ÖN Yön : Sol Ve Sağ Ağırlık : 1,300 kg / 2.866 lb	6C0199262A
	<b>VW12028</b> MOTOR TAKOZU SOL VE SAĞ MOTOR TAKOZU	Yön : Sol Ve Sağ Ağırlık : 1.1 kg / 2.425 lb Not : MOTOR TAKOZU	6Q0199851, 6Q0199851AK
	<b>VW12069</b> MOTOR TAKOZU SOL VE SAĞ MOTOR TAKOZU	Yön : Sol Ve Sağ Ağırlık : 0.83 kg / 1.830 lb Not : MOTOR TAKOZU	6Q0199851AB, 6Q0199851AK
	<b>VW12080</b> MOTOR TAKOZU SOL VE SAĞ MOTOR TAKOZU	Yön : Sol Ve Sağ Ağırlık : 2.02 kg / 4.453 lb Not : MOTOR TAKOZU	6Q0199167AQ, 6Q0199167BM 6Q0199167BQ, 6Q0199167BR 6Q0199167CA, 6Q0199167CB 6Q0199167CC, 6Q0199167CE 6Q0199167CJ, 6Q0199167CR
	<b>VW12083</b> MOTOR TAKOZU SOL VE SAĞ MOTOR TAKOZU	Yön : Sol Ve Sağ Ağırlık : 1.95 kg / 4.299 lb Not : MOTOR TAKOZU	6Q0199167BC, 6Q0199167BN 6Q0199167CH, 6Q0199167CL 6Q0199167DA, 6Q0199167DB 6Q0199167DL, 6Q0199167DM 6R0199167AA
	<b>VW12093</b> MOTOR TAKOZU SOL VE SAĞ MOTOR TAKOZU	Yön : Sol Ve Sağ Ağırlık : 1.05 kg / 2.315 lb Not : MOTOR TAKOZU	6Q0199851AC, 6Q0199851AL 6Q0199851AR, 6Q0199851E 6Q0199851S
	<b>VW12101</b> SÜSPANSİYON TAKOZU SOL VE SAĞ SÜSPANSİYON TAKOZU	Yön : Sol Ve Sağ Ağırlık : 0.07 kg / 0.154 lb Not : SÜSPANSİYON TAKOZU	6Q0512131C
	<b>SK12006</b> EGZOZ TAKOZU	Ağırlık : 0,185 kg / 0.408 lb	6Q0253144B, 6Q0253144D
	<b>VW12086</b> RADYATÖR TAKOZU SOL VE SAĞ RADYATÖR ÜST LASTİĞİ	Yön : Sol Ve Sağ Ağırlık : 0.024 kg / 0.053 lb Not : RADYATÖR ÜST LASTİĞİ	1K0121367F

\* Bu sayfada ve katalogdaki tüm araçların adları, markaları, modelleri, sembolleri, logoları, orjinal numaraları (oe) ve diğer üçüncü parti numaraları sadece referans amaçlı kullanılmaktadır.

**IBIZA**
**V 6J**
**2009 - 2017**





Resim	Ürün Kodu ve Açıklaması	Detay	OEM
	<b>AU14001</b> AKS KÖRÜĞÜ +KELEPÇE+YAĞ.	Ağırlık : 0.233 kg / 0.514 lb	6Q0498203A
	<b>VW14003</b> AKS KÖRÜĞÜ +KELEPÇE+YAĞ. DIŞ	Ağırlık : 0.25 kg / 0.551 lb	1K0 498 203, 1K0498203

**IBIZA**
**VI 6F**
**2017 -**





Resim	Ürün Kodu ve Açıklaması	Detay	OEM
	<b>VW1014</b> ROTİL ÖN ALT SAĞ Ø15,6 RB2536	Ağırlık : 0,565 kg / 1.246 lb Konik Ölçüsü : Ø15,6 Bağlantı Delik Çapı : Ø10,5 Aşık Diş Çapı : M12X1,5	1K0407366B, 1K0407366C 1K0407366E, 5Q0407366A
	<b>VW1015</b> ROTİL ÖN ALT SOL Ø15,6 RB2537	Ağırlık : 0,565 kg / 1.246 lb Konik Ölçüsü : Ø15,6 Bağlantı Delik Çapı : Ø10,5 Aşık Diş Çapı : M12X1,5	1K0407365B, 1K0407365C 1K0407365E, 5Q0407365A
	<b>VW2008</b> ROTBAŞI ÖN SAĞ RD0342	Ağırlık : 0,412 kg / 0.908 lb Uzunluk : 95 mm / 3.74 inch Gövde Diş Çapı : M16X1,5 Aşık Diş Çapı : M12X1,5 Aşık Konik Çapı : Ø12,7	1K0423812A, 1K0423812C 1K0423812E, 1K0423812G 1K0423812J, 1K0423812K 1KD423812A
	<b>VW2009</b> ROTBAŞI ÖN SOL RD0343	Ağırlık : 0,412 kg / 0.908 lb Uzunluk : 95 mm / 3.74 inch Gövde Diş Çapı : M16X1,5 Aşık Diş Çapı : M12X1,5 Aşık Konik Çapı : Ø13,5	1K0423811A, 1K0423811C 1K0423811E, 1K0423811G 1K0423811J, 1K0423811K 1KD423811A
	<b>VW3025</b> ROTMİLİ SOL VE SAĞ 311	Ağırlık : 0,676 kg / 1.490 lb Uzunluk : 311 mm / 12.24 inch Gövde Diş Çapı : M14X1,5 Aşık Diş Çapı : M16X1,5	2Q0423810D
	<b>VW6063</b> SALINCAK ÖN ALT SAĞ	Ağırlık : 3,004 kg / 6.623 lb Malzeme Türü : Sac Metal	2Q0407152B
	<b>VW6063J</b> SALINCAK ÖN ALT SAĞ	Ağırlık : 2,439 kg / 5.377 lb Malzeme Türü : Sac Metal	2Q0407152B
	<b>VW6064</b> SALINCAK ÖN ALT SOL	Ağırlık : 3,004 kg / 6.623 lb Malzeme Türü : Sac Metal	2Q0407151B

\* Bu sayfada ve katalogdaki tüm araçların adları, markaları, modelleri, sembolleri, logoları, orjinal numaraları (oe) ve diğer üçüncü parti numaraları sadece referans amaçlı kullanılmaktadır.

**IBIZA**
**VI 6F**
**2017 -**











Resim	Ürün Kodu ve Açıklaması	Detay	OEM
	<b>VW6064J</b> SALINCAK ÖN ALT SOL	Ağırlık : 2,439 kg / 5.377 lb Malzeme Türü : Sac Metal	2Q0407151B
	<b>AU11005</b> SALINCAK VE DENGE KOLU BURCU ÖN ORTA SOL VE SAĞ B40115	Şasi (Ön / Arka) : ÖN Yön : Orta Sol Ve Sağ Ağırlık : 0,111 kg / 0.245 lb Not : VW6014 - VW60614J	191407182, 357407182 357407182F
	<b>AU12027</b> AMORTİSÖR TAKOZU ARKA ÜST SAĞ	Şasi (Ön / Arka) : ARKA Yön : Üst Sağ Ağırlık : 0,415 kg / 0.915 lb	5Q0513353H
	<b>SE12003</b> MOTOR TAKOZU ÖN SOL VE SAĞ	Şasi (Ön / Arka) : ÖN Yön : Sol Ve Sağ Ağırlık : 1,900 kg / 4.189 lb	6C0199167B
	<b>SK12005</b> MOTOR TAKOZU ÖN SAĞ	Şasi (Ön / Arka) : ÖN Yön : Sağ Ağırlık : 1,575 kg / 3.472 lb	5Q0199262CK

**INCA**
**II 6K9**
**1995 - 2003**

Resim	Ürün Kodu ve Açıklaması	Detay	OEM
	<b>VW1012</b> ROTİL ALT SOL VE SAĞ	Ağırlık : 0,353 kg / 0.778 lb Bağlantı Delik Çapı : Ø8,5	357407365, 357407365A
	<b>VW1012K</b> ROTİL ALT SAĞ-SOL 19 RD0515	Ağırlık : 0,445 kg / 0.981 lb Bağlantı Delik Çapı : Ø8,5	357407365, 357407365A* 357407365A, 357407365S 357407365-S1
	<b>SE2003</b> ROTBAŞI SAĞ	Ağırlık : 0,37 kg / 0.816 lb Uzunluk : 92 mm / 3.62 inch Gövde Diş Çapı : M14X1,5 Aşık Diş Çapı : M12X1,5 Aşık Konik Çapı : Ø12,6	1J0422812E, 3A0422812 3A0422812A
	<b>SE2004</b> ROTBAŞI SOL	Ağırlık : 0,37 kg / 0.816 lb Uzunluk : 92 mm / 3.62 inch Gövde Diş Çapı : M14X1,5 Aşık Diş Çapı : M12X1,5 Aşık Konik Çapı : Ø12,6	1J0422811E, 3A0422811 3A0422811A
	<b>SE3002</b> ROTMİLİ SOL VE SAĞ 318	Ağırlık : 0,578 kg / 1.274 lb Uzunluk : 318 mm / 12.52 inch	6K0422803D, 6K0422804D 6K0422807D







\* Bu sayfada ve katalogdaki tüm araçların adları, markaları, modelleri, sembolleri, logoları, orjinal numaraları (oe) ve diğer üçüncü parti numaraları sadece referans amaçlı kullanılmaktadır.

**INCA**
**II 6K9**
**1995 - 2003**



Resim	Ürün Kodu ve Açıklaması	Detay	OEM
	<b>SE20033002</b> ROT TAKIMI ÖN AKS SAĞ	Ağırlık : 0,96 kg / 2.116 lb Rotbaşı : SE2003 Rotmili : SE3002	6K0422804A, 6K0422804D
	<b>SE20043002</b> ROT TAKIMI ÖN AKS SOL	Ağırlık : 0,96 kg / 2.116 lb Rotbaşı : SE2004 Rotmili : SE3002	6K0422803A, 6K0422803D
	<b>VW4004</b> Z ROT ÖN SAĞ - SOL KOMPLE RD0942	Ağırlık : 0,189 kg / 0.417 lb Malzeme Türü : Komple Uzunluk : 75 mm / 2.95 inch	191411315, 191411315B 191411315BKIT, 191411315BS
	<b>VW4008</b> Z ROT ÖN SAĞ - SOL METAL RD0923	Ağırlık : 0,166 kg / 0.366 lb Malzeme Türü : Metal Uzunluk : 77 mm / 3.03 inch Aşık Diş Çapı : M8X1,25	191411315A, 191411315B 191411315BK
	<b>VW6004J</b> SALINCAK ÖN RD1103	Ağırlık : 2,605 kg / 5.743 lb Malzeme Türü : Sac Metal	191.407.151B, 191407151A 191407151B
	<b>VW12111</b> VİRAJ DEMİR LASTİĞİ SOL VE SAĞ RUBBER	Şasi (Ön / Arka) : ÖN Yön : Sol Ve Sağ Ağırlık : 0.015 kg / 0.033 lb Malzeme Türü : Rubber Not : VİRAJ LASTİĞİ	191411329, 6N0411329
	<b>VW12111K</b> VİRAJ DEMİR LASTİĞİ SOL VE SAĞ RUBBER	Şasi (Ön / Arka) : ÖN Yön : Sol Ve Sağ Ağırlık : 0.03 kg / 0.066 lb Malzeme Türü : Rubber	191411329*, 6N0411329*
	<b>VW12008</b> MOTOR TAKOZU SOL VE SAĞ MOTOR TAKOZU	Yön : Sol Ve Sağ Ağırlık : 0.574 kg / 1.265 lb Not : MOTOR TAKOZU	357199381C, 357199402B 3A0199402
	<b>VW12074</b> MOTOR TAKOZU SOL VE SAĞ MOTOR TAKOZU	Yön : Sol Ve Sağ Ağırlık : 1.08 kg / 2.381 lb Not : MOTOR TAKOZU	1H0199609B, 1H0199609F 1H0199609G, 1H0199609J
	<b>VW12092</b> MOTOR TAKOZU SAĞ MOTOR TAKOZU ARKA SAĞ	Yön : Sağ Ağırlık : 1,745 kg / 3.847 lb Not : MOTOR TAKOZU ARKA SAĞ	1H0199262B, 1H0199262G 1H0199262H
	<b>VW12098</b> MOTOR TAKOZU SOL VE SAĞ MOTOR TAKOZU	Yön : Sol Ve Sağ Ağırlık : 1,565 kg / 3.450 lb Not : MOTOR TAKOZU	1H0199262E

\* Bu sayfada ve katalogdaki tüm araçların adları, markaları, modelleri, sembolleri, logoları, orijinal numaraları (oe) ve diğer üçüncü parti numaraları sadece referans amaçlı kullanılmaktadır.

**INCA**
**II 6K9**
**1995 - 2003**

Resim	Ürün Kodu ve Açıklaması	Detay	OEM
	<b>VW12135</b> EGZOZ TAKOZU	Ağırlık : 0,155 kg / 0.342 lb	1H0253144, 1H0253144A 1H0253144C, 1H0253409C 6N0253144
	<b>VW13008</b> DİREKSİYON KÖRÜĞÜ	Ağırlık : 0.225 kg / 0.496 lb	1H0422831B
	<b>VW13010</b> DİREKSİYON KÖRÜĞÜ ÖN	Ağırlık : 0,124 kg / 0.273 lb	191422831
	<b>RN14006</b> AKS KÖRÜĞÜ +KELEPÇE+YAĞ. DIŞ	Ağırlık : 0.2 kg / 0.441 lb	1603180, 1603204 16410170470106*, 16500170470106* 1H0498203, 271648 271649, 321498203A
	<b>VW14013</b> AKS KÖRÜĞÜ +KELEPÇE+YAĞ. YAĞ+KELEPÇE	Ağırlık : 0.156 kg / 0.344 lb	113501149, 171407283A
	<b>VW14014</b> AKS KÖRÜĞÜ +KELEPÇE+YAĞ. YAĞ+KELEPÇE	Ağırlık : 0.28 kg / 0.617 lb	191498203C, 71498203
	<b>AU15001</b> AMORTİSÖR KÖRÜĞÜ ÖN	Şasi (Ön / Arka) : ÖN Ağırlık : 0,110 kg / 0.243 lb	6N0413175A

**LEON**
**1M1**
**1999 - 2006**

Resim	Ürün Kodu ve Açıklaması	Detay	OEM
	<b>AU1013</b> ROTİL ÖN ALT SAĞ - SOL Ø15,5 RB2535	Ağırlık : 0,555 kg / 1.224 lb Konik Ölçüsü : Ø15,5 Bağlantı Delik Çapı : Ø10,7 Aşık Diş Çapı : M12X1,5	8N0.407.365A, 8N0.407.365B 8N0.407.365C, 8N0407365A 8N0407365B, 8N0407365C
	<b>AU1014</b> ROTİL ALT SAĞ Ø15	Ağırlık : 0,35 kg / 0.772 lb Konik Ölçüsü : Ø15 Bağlantı Delik Çapı : Ø8,5 Aşık Diş Çapı : M12X1,25	1J0407366A, 1J0407366AS 1J0407366B, 1J0407366C 1J0407366D, 1J0407366H
	<b>AU1014K</b> ROTİL ÖN SAĞ Ø15 RB2530	Ağırlık : 0,5 kg / 1.102 lb Konik Ölçüsü : Ø15 Bağlantı Delik Çapı : Ø8,5 Aşık Diş Çapı : M12X1,25	1J0407366, 1J0407366A 1J0407366AS, 1J0407366B 1J0407366C, 1J0407366CS 1J0407366D*, 1J0407366D 1J0407366H, 8Z0407366A

\* Bu sayfada ve katalogdaki tüm araçların adları, markaları, modelleri, sembolleri, logoları, orjinal numaraları (oe) ve diğer üçüncü parti numaraları sadece referans amaçlı kullanılmaktadır.

**LEON**
**1M1**
**1999 - 2006**

Resim	Ürün Kodu ve Açıklaması	Detay	OEM
	<b>AU1015</b> ROTİL SOL	Ağırlık : 0,35 kg / 0.772 lb Konik Ölçüsü : Ø15 Bağlantı Delik Çapı : Ø8,5 Aşık Dış Çapı : M12X1,25	1J0407365A, 1J0407365B 1J0407365C, 1J0407365D
	<b>AU1015K</b> ROTİL ÖN SOL Ø15 RB2529	Ağırlık : 0,5 kg / 1.102 lb Konik Ölçüsü : Ø15 Bağlantı Delik Çapı : Ø8,5 Aşık Dış Çapı : M12X1,25	1J0407365, 1J0407365A* 1J0407365A, 1J0407365AS 1J0407365B*, 1J0407365B 1J0407365C*, 1J0407365C 1J0407365CS, 1J0407365D*
	<b>AU2009</b> ROTBAŞI SAĞ UZUN RD0332	Ağırlık : 0,37 kg / 0.816 lb Uzunluk : 92 mm / 3.62 inch Gövde Dış Çapı : M14X1,5 Aşık Dış Çapı : M12X1,5 Aşık Konik Çapı : Ø13,3	1J0422812B, 3A0422812B 6R0423812A
	<b>AU2010</b> ROTBAŞI SOL RD0331	Ağırlık : 0,375 kg / 0.827 lb Uzunluk : 92 mm / 3.62 inch Gövde Dış Çapı : M14X1,5 Aşık Dış Çapı : M12X1,5 Aşık Konik Çapı : Ø13,2	1J0422811B, 1JD422811 3A0422811B, 6R0423811A
	<b>AU2318</b> ROTBAŞI SOL KISA RB2318	Ağırlık : 0,312 kg / 0.688 lb Uzunluk : 76 mm / 2.99 inch Gövde Dış Çapı : M14X1,5 Aşık Dış Çapı : M12X1,5 Aşık Konik Çapı : Ø13,4	1J0422811, 1J0422811A
	<b>AU2319</b> ROTBAŞI SAĞ KISA RB2319	Ağırlık : 0,315 kg / 0.694 lb Uzunluk : 76 mm / 2.99 inch Gövde Dış Çapı : M14X1,5 Aşık Dış Çapı : M12X1,5 Aşık Konik Çapı : Ø13,4	1J0422812, 1J0422812A
	<b>AU3001</b> ROTMİLİ SOL VE SAĞ 318 RD0908	Ağırlık : 0,622 kg / 1.371 lb Uzunluk : 318 mm / 12.52 inch Gövde Dış Çapı : M16X1,5 Aşık Dış Çapı : M14X1,5	1J0422803B, 1J0422804B 1J0422804E, 1J0422807 1J0422807B, 1J0422821B
	<b>AU3004</b> ROTMİLİ	Ağırlık : 0.35 kg / 0.772 lb Uzunluk : 320 mm / 12.60 inch	1J0422810B

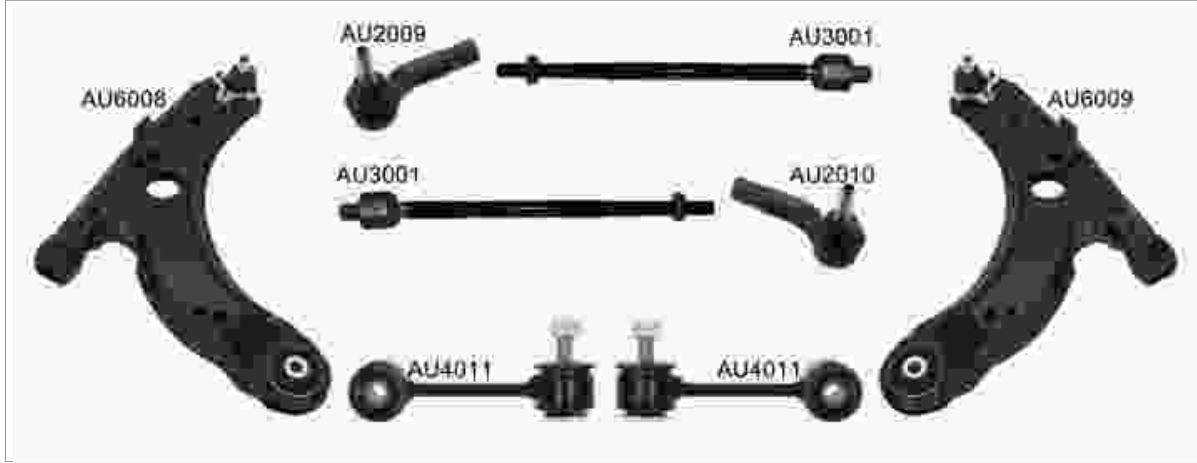
**VW8001 / Süspansiyon Kit Ön**
**LEON**
**1M1**
**1999 - 2006**

**Kit Parçaları**

Resim	Ürün Kodu / Adı	OEM	OEM	Ürün Kodu / Adı	Resim
	<b>AU2009</b> Rotbaşı Sağ Uzun Rd0332	1J0422812B, 3A0422812B 6R0423812A	1J0422811B, 1JD422811 3A0422811B, 6R0423811A	<b>AU2010</b> Rotbaşı Sol Rd0331	
	<b>AU3001</b> Rotmili Sol Ve Sağ 318 Rd0908	1J0422803B, 1J0422804B 1J0422804E, 1J0422807 1J0422807B, 1J0422821B	1J0411315E, 1J0411315G 1J0422315G	<b>VW4011</b> Z Rot Ön Sağ-sol Metal 105 Rd0916	
	<b>AU6008</b> Salıncak Ön Sağ Rb3011	1J0407151B	1J0407151A	<b>AU6009</b> Salıncak Ön Sol Rb3012	

**VW8003 / Süspansiyon Kit Ön**

**LEON**

**1M1**

**1999 - 2006**



**Kit Parçaları**

Resim	Ürün Kodu / Adı	OEM	OEM	Ürün Kodu / Adı	Resim
	<b>AU1014</b> Rotil Alt Sağ Ø15	1J0407366A, 1J0407366AS 1J0407366B, 1J0407366C 1J0407366D, 1J0407366H	1J0407365A, 1J0407365B 1J0407365C, 1J0407365D	<b>AU1015</b> Rotil Sol	
	<b>AU11002</b> Salıncak Ve Denge Kolu Burcu Ön Sol Ve Sağ B22117	1J0407181, 1J0407181A	191407182, 357407182 357407182F	<b>AU11005</b> Salıncak Ve Denge Kolu Burcu Ön Orta Sol Ve Sağ B40115	
	<b>VW4011</b> Z Rot Ön Sağ-sol Metal 105 Rd0916	1J0411315E, 1J0411315G 1J0422315G			





**LEON**
**1M1**
**1999 - 2006**

Resim	Ürün Kodu ve Açıklaması	Detay	OEM
	<b>AU20093001</b> ROT TAKIMI SAĞ	Ağırlık : 0,951 kg / 2.097 lb Rotbaşı : AU2009 Rotmili : AU3001	1H0422804B
	<b>AU20093004</b> ROT TAKIMI SAĞ KOMPLE	Ağırlık : 1.1 kg / 2.425 lb Rotbaşı : AU2009 Rotmili : AU3004	1J0422804B, 1J0422804C
	<b>AU20103001</b> ROT TAKIMI SOL	Ağırlık : 0,952 kg / 2.099 lb Rotbaşı : AU2010 Rotmili : AU3001	1H0422803B
	<b>AU20103004</b> ROT TAKIMI SOL KOMPLE	Ağırlık : 1.1 kg / 2.425 lb Rotbaşı : AU2010 Rotmili : AU3004	1J0422803B, 1J0422803C
	<b>AU23183004</b> ROT TAKIMI SOL RD088206	Ağırlık : 1.075 kg / 2.370 lb Rotbaşı : AU2318 Rotmili : AU3004	1J0422803B
	<b>AU23193004</b> ROT TAKIMI SAĞ RD088207	Ağırlık : 1.1 kg / 2.425 lb Rotbaşı : AU2319 Rotmili : AU3004	1J0422804B
	<b>AU4005</b> Z ROT ÖN SOL METAL RB2924	Ağırlık : 0,602 kg / 1.327 lb Malzeme Türü : Metal Uzunluk : 335 mm / 13.19 inch Aşık Diş Çapı : M12X1,5	1J0411315D, 1J0411615D
	<b>AU4006</b> Z ROT ÖN SAĞ METAL RB2923	Ağırlık : 0,282 kg / 0.622 lb Malzeme Türü : Metal Uzunluk : 335 mm / 13.19 inch Aşık Diş Çapı : M12X1,5	1J0411316D
	<b>VW4010</b> Z ROT SOL VE SAĞ PLASTİK RD0924	Ağırlık : 0,18 kg / 0.397 lb Malzeme Türü : Plastik Uzunluk : 106 mm / 4.17 inch Aşık Diş Çapı : M10X1,5	1J0411315C, 1J0411315J
	<b>VW4011</b> Z ROT ÖN SAĞ-SOL METAL 105 RD0916	Ağırlık : 0,258 kg / 0.569 lb Malzeme Türü : Metal Uzunluk : 106 mm / 4.17 inch Aşık Diş Çapı : M10X1,5	1J0411315E, 1J0411315G 1J0422315G
	<b>VW4020</b> Z ROT ÖN SAĞ-SOL PLASTİK 105,5	Ağırlık : 0,151 kg / 0.333 lb Malzeme Türü : Plastik Uzunluk : 105 mm / 4.13 inch	1J0411315B, 1J0411315H 1J0411315K











\* Bu sayfada ve katalogdaki tüm araçların adları, markaları, modelleri, sembolleri, logoları, orijinal numaraları (oe) ve diğer üçüncü parti numaraları sadece referans amaçlı kullanılmaktadır.

**LEON**
**1M1**
**1999 - 2006**

Resim	Ürün Kodu ve Açıklaması	Detay	OEM
	<b>AU6008</b> SALINCAK ÖN SAĞ RB3011	Ağırlık : 3,495 kg / 7.705 lb Malzeme Türü : Sac Metal	1J0407151B
	<b>AU6008J</b> SALINCAK ÖN SAĞ RB3101	Ağırlık : 3,212 kg / 7.081 lb Malzeme Türü : Sac Metal	1J0407151C
	<b>AU6009</b> SALINCAK ÖN SOL RB3012	Ağırlık : 3,495 kg / 7.705 lb Malzeme Türü : Sac Metal	1J0407151A
	<b>SE9003</b> SALINCAK ALT VE ÜST SOL VE SAĞ	Ağırlık : 1,080 kg / 2.381 lb Malzeme Türü : Sac Metal	1J0505323H, 1J0505323J 1J0505323L, 1J0505323M 1J0505323N
	<b>AU11002</b> SALINCAK VE DENGE KOLU BURCU ÖN SOL VE SAĞ B22117	Şasi (Ön / Arka) : ÖN Yön : Sol Ve Sağ Ağırlık : 0,108 kg / 0.238 lb	1J0407181, 1J0407181A
	<b>AU11005</b> SALINCAK VE DENGE KOLU BURCU ÖN ORTA SOL VE SAĞ B40115	Şasi (Ön / Arka) : ÖN Yön : Orta Sol Ve Sağ Ağırlık : 0,111 kg / 0.245 lb Not : VW6014 - VW60614J	191407182, 357407182 357407182F
	<b>VW11036</b> SALINCAK VE DENGE KOLU BURCU SOL VE SAĞ	Yön : Sol Ve Sağ Ağırlık : 0.07 kg / 0.154 lb Not : BORUSU	191411315B, 4A0399413A
	<b>VW11090</b> Z-ROT BURCU ÖN	Şasi (Ön / Arka) : ÖN Ağırlık : 0,045 kg / 0.099 lb	1J0411315*, 1J0411315B* 1J0411315C*, 1J0411315E* 1J0411315G*, 1J0411315J*
	<b>VW11008</b> TAŞIYICI DESTEK BURÇLARI SOL VE SAĞ	Yön : Sol Ve Sağ Ağırlık : 0.24 kg / 0.529 lb	1J0505203, 1J0505365D 1J0505365F, 1J0505365G 1J0505365J, 1J0505365K 1J0505365M, 1J0505365N
	<b>VW12159</b> TAŞIYICI DESTEK BURÇLARI ARKA SOL VE SAĞ	Şasi (Ön / Arka) : ARKA Yön : Sol Ve Sağ Ağırlık : 0,130 kg / 0.287 lb	1K0505553, 1K0505553A
	<b>VW12010</b> TORSİYON BURCU SOL VE SAĞ	Yön : Sol Ve Sağ Ağırlık : 0.31 kg / 0.683 lb	1J0500045, 1J0500045A 1J0501541B, 1J0501541C 6R0501541A, 6R0501541B

\* Bu sayfada ve katalogdaki tüm araçların adları, markaları, modelleri, sembolleri, logoları, orjinal numaraları (oe) ve diğer üçüncü parti numaraları sadece referans amaçlı kullanılmaktadır.

**LEON**
**1M1**
**1999 - 2006**

Resim	Ürün Kodu ve Açıklaması	Detay	OEM
	<b>VW12066</b> TORSİYON BURCU SOL VE SAĞ	Yön : Sol Ve Sağ Ağırlık : 0.6 kg / 1.323 lb	1J0 501 541 D, 1J0501541D
	<b>VW12016</b> VİRAJ DEMİR LASTİĞİ SOL VE SAĞ RUBBER	Şasi (Ön / Arka) : ÖN Yön : Sol Ve Sağ Ağırlık : 0.03 kg / 0.066 lb Malzeme Türü : Rubber	1J0411314G, 1J0411314T 8N0411303G, 8N0411303H
	<b>VW12016K</b> VİRAJ DEMİR LASTİĞİ SOL VE SAĞ RUBBER	Şasi (Ön / Arka) : ÖN Yön : Sol Ve Sağ Ağırlık : 0.06 kg / 0.132 lb Malzeme Türü : Rubber Not : İKİLİ	1J0411314G, 1J0411314T 8N0411303G, 8N0411303H
	<b>VW12020</b> VİRAJ DEMİR LASTİĞİ SOL VE SAĞ RUBBER	Şasi (Ön / Arka) : ÖN Yön : Sol Ve Sağ Ağırlık : 0.07 kg / 0.154 lb Malzeme Türü : Rubber Not : VİRAJ ORTA LASTİĞİ	8D0511327C
	<b>VW12020K</b> VİRAJ DEMİR LASTİĞİ SOL VE SAĞ RUBBER	Şasi (Ön / Arka) : ÖN Yön : Sol Ve Sağ Ağırlık : 0.14 kg / 0.309 lb Malzeme Türü : Rubber	8D0511327C*
	<b>VW12052</b> VİRAJ DEMİR LASTİĞİ SOL VE SAĞ RUBBER	Şasi (Ön / Arka) : ÖN Yön : Sol Ve Sağ Ağırlık : 0.06 kg / 0.132 lb Malzeme Türü : Rubber Not : VİRAJ LASTİĞİ	1J0411314R
	<b>VW12052K</b> VİRAJ DEMİR LASTİĞİ SOL VE SAĞ RUBBER	Şasi (Ön / Arka) : ÖN Yön : Sol Ve Sağ Ağırlık : 0.12 kg / 0.265 lb Malzeme Türü : Rubber	1J0411314R*
	<b>VW12064</b> VİRAJ DEMİR LASTİĞİ SOL VE SAĞ RUBBER	Şasi (Ön / Arka) : ÖN Yön : Sol Ve Sağ Ağırlık : 0.023 kg / 0.051 lb Malzeme Türü : Rubber Not : D=Ø21mm	1J0411314C, 1J0411314R
	<b>VW12064K</b> VİRAJ DEMİR LASTİĞİ SOL VE SAĞ RUBBER	Şasi (Ön / Arka) : ÖN Yön : Sol Ve Sağ Ağırlık : 0.046 kg / 0.101 lb Malzeme Türü : Rubber	1J0411314C*
	<b>VW12117</b> VİRAJ DEMİR LASTİĞİ SOL VE SAĞ RUBBER	Şasi (Ön / Arka) : ÖN Yön : Sol Ve Sağ Ağırlık : 0.08 kg / 0.176 lb Malzeme Türü : Rubber	1J0411327
	<b>VW12117K</b> VİRAJ DEMİR LASTİĞİ SOL VE SAĞ RUBBER	Şasi (Ön / Arka) : ÖN Yön : Sol Ve Sağ Ağırlık : 0.16 kg / 0.353 lb Malzeme Türü : Rubber	1J0411327









\* Bu sayfada ve katalogdaki tüm araçların adları, markaları, modelleri, sembolleri, logoları, orjinal numaraları (oe) ve diğer üçüncü parti numaraları sadece referans amaçlı kullanılmaktadır.

**LEON**
**1M1**
**1999 - 2006**

Resim	Ürün Kodu ve Açıklaması	Detay	OEM
	<b>SK12002</b> AMORTİSÖR TAKOZU ARKA SOL VE SAĞ 1.2 / 1.4TSI / 1.6TDI / 1.2TDI	Şasi (Ön / Arka) : ARKA Yön : Sol Ve Sağ Ağırlık : 0,305 kg / 0.672 lb Not : 1.2 / 1.4TSI / 1.6TDI / 1.2TDI	1J0513353A, 1J0513353B 1J0513353C, 1J0513353G 6QE513353, 6R0513353 6R0513353B
	<b>VW12061</b> AMORTİSÖR TAKOZU SOL VE SAĞ AMORTİSÖR TAKOZU	Yön : Sol Ve Sağ Ağırlık : 0.27 kg / 0.595 lb Not : AMORTİSÖR TAKOZU	1H0412365A, 1J0412249 1J0412331BS, 1J0412331C
	<b>VW12061A</b> AMORTİSÖR TAKOZU SOL VE SAĞ AMORTİSÖR RULMANI	Yön : Sol Ve Sağ Ağırlık : 0.08 kg / 0.176 lb Not : AMORTİSÖR RULMANI	1J0412249, 1J0412249C 357412249, 357412249A 4503300051, 7201688 7201848, 95VW3K031AA
	<b>VW12061K</b> AMORTİSÖR TAKOZU SOL VE SAĞ 2 PCS	Yön : Sol Ve Sağ Ağırlık : 0.7 kg / 1.543 lb Not : 2 PCS	1H0412365A, 1J0412249 1J0412331BS, 1J0412331C
	<b>VW12103</b> AMORTİSÖR TAKOZU SOL VE SAĞ AMORTİSÖR ÜST TAKOZU	Yön : Sol Ve Sağ Ağırlık : 0.23 kg / 0.507 lb Not : AMORTİSÖR ÜST TAKOZU	1J0412331B, 1J0412331C
	<b>VW12030</b> MOTOR TAKOZU SOL VE SAĞ MOTOR TAKOZU ARKA	Yön : Sol Ve Sağ Ağırlık : 1.15 kg / 2.535 lb Not : MOTOR TAKOZU ARKA	1J0199851, 1J0199851AK
	<b>VW12040</b> MOTOR TAKOZU SOL VE SAĞ MOTOR TAKOZU	Yön : Sol Ve Sağ Ağırlık : 1.641 kg / 3.618 lb Not : MOTOR TAKOZU	1J0199555AA, 1J0199555AK
	<b>VW12070</b> MOTOR TAKOZU SOL VE SAĞ MOTOR TAKOZU	Yön : Sol Ve Sağ Ağırlık : 1.64 kg / 3.616 lb Not : MOTOR TAKOZU	1J0199555AH
	<b>VW12075</b> MOTOR TAKOZU SOL VE SAĞ MOTOR TAKOZU	Yön : Sol Ve Sağ Ağırlık : 2.2 kg / 4.850 lb Not : MOTOR TAKOZU	1J0199262BF
	<b>VW12081</b> MOTOR TAKOZU SOL VE SAĞ MOTOR TAKOZU	Yön : Sol Ve Sağ Ağırlık : 2.04 kg / 4.497 lb Not : MOTOR TAKOZU	1J0199262BK
	<b>VW12084</b> MOTOR TAKOZU SOL VE SAĞ MOTOR TAKOZU	Yön : Sol Ve Sağ Ağırlık : 2.034 kg / 4.484 lb Not : MOTOR TAKOZU	1J0199262BE

\* Bu sayfada ve katalogdaki tüm araçların adları, markaları, modelleri, sembolleri, logoları, orijinal numaraları (oe) ve diğer üçüncü parti numaraları sadece referans amaçlı kullanılmaktadır.

**LEON**
**1M1**
**1999 - 2006**

Resim	Ürün Kodu ve Açıklaması	Detay	OEM
	<b>VW12100</b> MOTOR TAKOZU SOL VE SAĞ MOTOR TAKOZU ARKA	Yön : Sol Ve Sağ Ağırlık : 1.12 kg / 2.469 lb Not : MOTOR TAKOZU ARKA	1J0199851AA, 1J0199851AK 1J0199851M, 1J0199851N
	<b>VW12102</b> MOTOR TAKOZU SOL VE SAĞ MOTOR TAKOZU	Yön : Sol Ve Sağ Ağırlık : 1.64 kg / 3.616 lb Not : MOTOR TAKOZU	1J0199555AJ, 1J0199555AM 1J0199555AQ, 1J0199555BH
	<b>VW12096</b> SÜSPANSİYON TAKOZU SOL VE SAĞ SÜSPANSİYON TAKOZU	Yön : Sol Ve Sağ Ağırlık : 0.035 kg / 0.077 lb Not : SÜSPANSİYON TAKOZU	1J0412303
	<b>VW13002</b> RIW DİREKSİYON KÖRÜĞÜ	Ağırlık : 0.1 kg / 0.220 lb	1J0422831, 1J0422831B 8N0422831
	<b>VW13002K</b> DİREKSİYON KÖRÜĞÜ SOL VE SAĞ 2 PİECES	Ağırlık : 0.2 kg / 0.441 lb	1J0422831, 1J0422831B 8N0422831
	<b>F114014</b> AKS KÖRÜĞÜ +KELEPÇE+YAĞ. DIŞ	Ağırlık : 0.211 kg / 0.465 lb	46307841
	<b>VW14003</b> AKS KÖRÜĞÜ +KELEPÇE+YAĞ. DIŞ	Ağırlık : 0.25 kg / 0.551 lb	1K0 498 203, 1K0498203
	<b>VW15002</b> AMORTİSÖR KÖRÜĞÜ ARKA	Şasi (Ön / Arka) : ARKA	900064

**LEON**
**1P1**
**2006 - 2012**

Resim	Ürün Kodu ve Açıklaması	Detay	OEM
	<b>VW1014</b> ROTİL ÖN ALT SAĞ Ø15,6 RB2536	Ağırlık : 0,565 kg / 1.246 lb Konik Ölçüsü : Ø15,6 Bağlantı Delik Çapı : Ø10,5 Aşık Dış Çapı : M12X1,5	1K0407366B, 1K0407366C 1K0407366E, 5Q0407366A
	<b>VW1015</b> ROTİL ÖN ALT SOL Ø15,6 RB2537	Ağırlık : 0,565 kg / 1.246 lb Konik Ölçüsü : Ø15,6 Bağlantı Delik Çapı : Ø10,5 Aşık Dış Çapı : M12X1,5	1K0407365B, 1K0407365C 1K0407365E, 5Q0407365A

\* Bu sayfada ve katalogdaki tüm araçların adları, markaları, modelleri, sembolleri, logoları, orjinal numaraları (oe) ve diğer üçüncü parti numaraları sadece referans amaçlı kullanılmaktadır.

**LEON**
**1P1**
**2006 - 2012**

Resim	Ürün Kodu ve Açıklaması	Detay	OEM
	<b>VW2008</b> ROTBAŞI ÖN SAĞ RD0342	Ağırlık : 0,412 kg / 0.908 lb Uzunluk : 95 mm / 3.74 inch Gövde Diş Çapı : M16X1,5 Aşık Diş Çapı : M12X1,5 Aşık Konik Çapı : Ø12,7	1K0423812A, 1K0423812C 1K0423812E, 1K0423812G 1K0423812J, 1K0423812K 1KD423812A
	<b>VW2009</b> ROTBAŞI ÖN SOL RD0343	Ağırlık : 0,412 kg / 0.908 lb Uzunluk : 95 mm / 3.74 inch Gövde Diş Çapı : M16X1,5 Aşık Diş Çapı : M12X1,5 Aşık Konik Çapı : Ø13,5	1K0423811A, 1K0423811C 1K0423811E, 1K0423811G 1K0423811J, 1K0423811K 1KD423811A
	<b>VW3009</b> ROTMİLİ SAĞ-SOL 310 RB2838	Ağırlık : 0,665 kg / 1.466 lb Uzunluk : 311 mm / 12.24 inch Gövde Diş Çapı : M16X1,5 Aşık Diş Çapı : M16X1,5	1K0423810A
	<b>VW20083009</b> ROT TAKIMI ÖN AKS SAĞ RB288137	Ağırlık : 1,078 kg / 2.377 lb Rotbaşı : VW2008 Rotmilî : VW3009	
	<b>VW20093009</b> ROT TAKIMI ÖN SOL RB288138	Ağırlık : 1,077 kg / 2.374 lb Rotbaşı : VW2009 Rotmilî : VW3009	
	<b>SK4005</b> Z ROT ÖM SAĞ-SOL L=335MM	Ağırlık : 0,322 kg / 0.710 lb Malzeme Türü : Metal Uzunluk : 335 mm / 13.19 inch Aşık Diş Çapı : M12X1,5	5Q0411315B
	<b>VW4014</b> Z ROT ÖN SAĞ-SOL METAL 335 RB2935	Ağırlık : 0,46 kg / 1.014 lb Malzeme Türü : Metal Uzunluk : 335 mm / 13.19 inch Aşık Diş Çapı : M12X1,5	1K0411315B, 1K0411315D 1K0411315J, 1K0411315K 1K0411315R, 5Q0411315A 5Q0411315B
	<b>VW4015</b> Z ROT SOL VE SAĞ METAL RB2937	Ağırlık : 0,373 kg / 0.822 lb Malzeme Türü : Metal Uzunluk : 95,5 mm / 3.76 inch Aşık Diş Çapı : M10X1,5	1K0505465C, 1K0505465D 1K0505465H, 1K0505465J 1K0505465K
	<b>VW4015K</b> Z ROT SOL VE SAĞ METAL	Ağırlık : 0,373 kg / 0.822 lb Malzeme Türü : Metal Uzunluk : 95,5 mm / 3.76 inch Aşık Diş Çapı : M10X1,5	1K0505465C, 1K0505465D 1K0505465H, 1K0505465J 1K0505465K
	<b>SE9001</b> SALINCAK ALT SAĞ RA5150	Ağırlık : 1 kg / 2.205 lb Malzeme Türü : Sac Metal	1K0501530C
	<b>SE9002</b> SALINCAK ALT SOL RA5151	Ağırlık : 1 kg / 2.205 lb Malzeme Türü : Sac Metal	1K0501529F











\* Bu sayfada ve katalogdaki tüm araçların adları, markaları, modelleri, sembolleri, logoları, orjinal numaraları (oe) ve diğer üçüncü parti numaraları sadece referans amaçlı kullanılmaktadır.

**LEON**
**1P1**
**2006 - 2012**

Resim	Ürün Kodu ve Açıklaması	Detay	OEM
	<b>SK9001</b> SALINCAK ARKA ALT	Ağırlık : 0,701 kg / 1.545 lb Malzeme Türü : Sac Metal	1K0501529J
	<b>VW6016</b> SALINCAK ÖN SAĞ RD10227	Ağırlık : 4,543 kg / 10.016 lb Malzeme Türü : Sac Metal	1K0407152P, 1K0407152Q* 1K0407152Q
	<b>VW6016J</b> SALINCAK ÖN ALT SAĞ S737	Ağırlık : 4,015 kg / 8.852 lb Malzeme Türü : Sac Metal	1K0407151P, 1K0407151Q 1K0407152P, 1K0407152Q
	<b>VW6017</b> SALINCAK ÖN SOL RD10226	Ağırlık : 4,543 kg / 10.016 lb Malzeme Türü : Sac Metal	1K0407151M*, 1K0407151P 1K0407151Q*, 1K0407151Q
	<b>VW6017J</b> SALINCAK ÖN ALT SOL S738	Ağırlık : 4,015 kg / 8.852 lb Malzeme Türü : Sac Metal	1K0407151P, 1K0407151Q 1K0407152P, 1K0407152Q
	<b>VW6018</b> SALINCAK ÖN SAĞ RB30219	Ağırlık : 4,85 kg / 10.692 lb Malzeme Türü : Döküm Çelik	1K0407152AC*, 1K0407152M* 1K0407152P, 1K0407152Q 1K0407152R*
	<b>VW6018J</b> SALINCAK ÖN SAĞ RB30211	Ağırlık : 4,232 kg / 9.330 lb Malzeme Türü : Döküm Çelik	1K0407152AC, 1K0407152M 1K0407152R
	<b>VW6019</b> SALINCAK ÖN SOL RB30218	Ağırlık : 4,85 kg / 10.692 lb Malzeme Türü : Döküm Çelik	1K0407151AC*, 1K0407151AC 1K0407151M*, 1K0407151M 1K0407151R*, 1K0407151R
	<b>VW6019J</b> SALINCAK ÖN SOL RB30212	Ağırlık : 4,232 kg / 9.330 lb Malzeme Türü : Döküm Çelik	1K0407151AC, 1K0407151M 1K0407151R
	<b>VW9001</b> SALINCAK ARKA	Ağırlık : 2,55 kg / 5.622 lb Malzeme Türü : Sac Metal	1K0505311AA, 1K0505311ABÂ 1K0505311H, 1K0505311S 1K0505311T
	<b>SK11009</b> SALINCAK VE DENGE KOLU BURCU ARKA SOL VE SAĞ	Şasi (Ön / Arka) : ARKA Yön : Sol Ve Sağ Ağırlık : 0,176 kg / 0.388 lb	1K0501529J*

\* Bu sayfada ve katalogdaki tüm araçların adları, markaları, modelleri, sembolleri, logoları, orjinal numaraları (oe) ve diğer üçüncü parti numaraları sadece referans amaçlı kullanılmaktadır.

**LEON**
**1P1**
**2006 - 2012**

Resim	Ürün Kodu ve Açıklaması	Detay	OEM
	<b>SK11010</b> SALINCAK VE DENGE KOLU BURCU ARKA SOL VE SAĞ	Şasi (Ön / Arka) : ARKA Yön : Sol Ve Sağ Ağırlık : 0,196 kg / 0.432 lb Not : BÜYÜK	1K0501529J*
	<b>VW11037</b> SALINCAK VE DENGE KOLU BURCU SOL VE SAĞ	Yön : Sol Ve Sağ Ağırlık : 0.11 kg / 0.243 lb	1K0505279A
	<b>VW11042</b> SALINCAK VE DENGE KOLU BURCU ORTA SOL VE SAĞ	Yön : Orta Sol Ve Sağ Ağırlık : 0,182 kg / 0.401 lb	1K0407182, 5Q0407182
	<b>VW11043</b> SALINCAK VE DENGE KOLU BURCU SAĞ B22141	Yön : Sağ Diğer Taraf : VW11044 Ağırlık : 0,659 kg / 1.453 lb	1K0199232G, 1K0199232H 1K0199232J
	<b>VW11043B</b> SALINCAK VE DENGE KOLU BURCU SAĞ	Yön : Sağ Diğer Taraf : VW11044B Ağırlık : 0,659 kg / 1.453 lb Not : İÇ BURÇSUZ	1K0199232G, 1K0199232H 1K0199232J
	<b>VW11044</b> SALINCAK VE DENGE KOLU BURCU SOL B22142	Yön : Sol Diğer Taraf : VW11043 Ağırlık : 0,678 kg / 1.495 lb	1K0199231G, 1K0199231H 1K0199231J
	<b>VW11044B</b> SALINCAK VE DENGE KOLU BURCU SOL	Yön : Sol Diğer Taraf : VW11043B Ağırlık : 0,678 kg / 1.495 lb Not : İÇ BURÇSUZ	1K0199231G, 1K0199231H 1K0199231J
	<b>VW11047</b> SALINCAK VE DENGE KOLU BURCU İÇ SOL VE SAĞ B37117	Yön : İç Sol Ve Sağ Ağırlık : 0,121 kg / 0.267 lb	1K0199231J, 1K0199231J-P 1K0407183E
	<b>VW11051</b> SALINCAK VE DENGE KOLU BURCU SOL VE SAĞ	Yön : Sol Ve Sağ Ağırlık : 0.121 kg / 0.267 lb	6Q0407183, 6Q0407183A
	<b>VW11055</b> SALINCAK VE DENGE KOLU BURCU İÇ SOL VE SAĞ	Yön : İç Sol Ve Sağ Ağırlık : 0.121 kg / 0.267 lb	1K0407183E, 8J0407183
	<b>VW11056</b> SALINCAK VE DENGE KOLU BURCU ARKA SOL VE SAĞ	Şasi (Ön / Arka) : ARKA Yön : Sol Ve Sağ Ağırlık : 0.13 kg / 0.287 lb	1K0505203A, 1K0505323D 1K0505323G, 1K0505323H 1K0505323N, 5Q0505323C

\* Bu sayfada ve katalogdaki tüm araçların adları, markaları, modelleri, sembolleri, logoları, orjinal numaraları (oe) ve diğer üçüncü parti numaraları sadece referans amaçlı kullanılmaktadır.



**LEON**
**1P1**
**2006 - 2012**

Resim	Ürün Kodu ve Açıklaması	Detay	OEM
	<b>VW11180</b> Z-ROT BURCU ARKA	Şasi (Ön / Arka) : ARKA Ağırlık : 0.069 kg / 0.152 lb Uzunluk : VW4015 mm / 0.00 inch Aşık Diş Çapı : VW4015K	1K0505465C*, 1K0505465D* 1K0505465H*, 1K0505465J* 1K0505465K*
	<b>VW12159</b> TAŞIYICI DESTEK BURÇLARI ARKA SOL VE SAĞ	Şasi (Ön / Arka) : ARKA Yön : Sol Ve Sağ Ağırlık : 0,130 kg / 0.287 lb	1K0505553, 1K0505553A
	<b>SK12003</b> VİRAJ DEMİR LASTİĞİ SOL VE SAĞ RUBBER	Şasi (Ön / Arka) : ÖN Yön : Sol Ve Sağ Ağırlık : 0,075 kg / 0.165 lb Malzeme Türü : Rubber	1K0411303, 1K0411303AL* 1K0411303BK, 1K0411314 3C0411303AA*, 3C0411303T*
	<b>SK12003K</b> VİRAJ DEMİR LASTİĞİ SOL VE SAĞ RUBBER	Şasi (Ön / Arka) : ÖN Yön : Sol Ve Sağ Ağırlık : 0,150 kg / 0.331 lb Malzeme Türü : Rubber	1K0411303, 1K0411303AL* 1K0411303BK, 1K0411314 3C0411303AA*, 3C0411303T*
	<b>VW12017</b> AMORTİSÖR TAKOZU SOL VE SAĞ AMORTİSÖR TAKOZU	Yön : Sol Ve Sağ Ağırlık : 0.847 kg / 1.867 lb Not : AMORTİSÖR TAKOZU	1K0412331B, 1K0412331C
	<b>VW12103</b> AMORTİSÖR TAKOZU SOL VE SAĞ AMORTİSÖR ÜST TAKOZU	Yön : Sol Ve Sağ Ağırlık : 0.23 kg / 0.507 lb Not : AMORTİSÖR ÜST TAKOZU	1J0412331B, 1J0412331C
	<b>VW12109</b> AMORTİSÖR TAKOZU SOL VE SAĞ AMORTİSÖR RULMANI	Yön : Sol Ve Sağ Ağırlık : 0.26 kg / 0.573 lb Not : AMORTİSÖR RULMANI	6N0412249C, 6N0412249E
	<b>VW12109K</b> AMORTİSÖR TAKOZU SOL VE SAĞ 2 PCS	Yön : Sol Ve Sağ Ağırlık : 0.52 kg / 1.146 lb Not : 2 PCS	6N0412249C, 6N0412249E
	<b>VW12025</b> MOTOR TAKOZU ALT SOL VE SAĞ MOTOR TAKOZU ALT	Yön : Alt Sol Ve Sağ Ağırlık : 0.25 kg / 0.551 lb Not : MOTOR TAKOZU ALT	1K0199867A, 1K0199867B 1K0199867Q
	<b>VW12027</b> MOTOR TAKOZU SOL VE SAĞ MOTOR KULAĞI	Yön : Sol Ve Sağ Ağırlık : 2.02 kg / 4.453 lb Not : MOTOR KULAĞI	1K0199262, 1K0199262CN
	<b>VW12029</b> MOTOR TAKOZU SOL VE SAĞ MOTOR TAKOZU	Yön : Sol Ve Sağ Ağırlık : 0.585 kg / 1.290 lb Not : Motor takozu	1K0199855AD, 1K0199855BA 1K0199855K





\* Bu sayfada ve katalogdaki tüm araçların adları, markaları, modelleri, sembolleri, logoları, orjinal numaraları (oe) ve diğer üçüncü parti numaraları sadece referans amaçlı kullanılmaktadır.

**LEON**
**1P1**
**2006 - 2012**





Resim	Ürün Kodu ve Açıklaması	Detay	OEM
	<b>VW12033</b> MOTOR TAKOZU SOL VE SAĞ MOTOR TAKOZU	Yön : Sol Ve Sağ Ağırlık : 1.84 kg / 4.057 lb Not : Motor takozu	1K0199555AQ, 1K0199555AR 1K0199555Q, 1K0199555R 3C0199555AA, 3C0199555R
	<b>VW12034</b> MOTOR TAKOZU SOL VE SAĞ MOTOR TAKOZU	Yön : Sol Ve Sağ Ağırlık : 1.9 kg / 4.189 lb Not : Motor takozu	1K0199555BA, 1K0199555BB 1K0199555L, 1K0199555M 1L0199555L
	<b>VW12073</b> MOTOR TAKOZU SOL VE SAĞ MOTOR TAKOZU	Yön : Sol Ve Sağ Ağırlık : 1.643 kg / 3.622 lb Not : MOTOR TAKOZU	1K0199262AC, 1K0199262AL 1K0199262L
	<b>VW12076</b> MOTOR TAKOZU SOL VE SAĞ MOTOR TAKOZU	Yön : Sol Ve Sağ Ağırlık : 1.97 kg / 4.343 lb Not : MOTOR TAKOZU	1K0199262AF, 1K0199262AT 1K0199262BB
	<b>VW12077</b> MOTOR TAKOZU SOL VE SAĞ MOTOR TAKOZU	Yön : Sol Ve Sağ Ağırlık : 1.95 kg / 4.299 lb Not : MOTOR TAKOZU	1K0199262CG, 1K0199262CP
	<b>VW12082</b> MOTOR TAKOZU SOL VE SAĞ MOTOR TAKOZU	Yön : Sol Ve Sağ Ağırlık : 2.05 kg / 4.519 lb Not : MOTOR TAKOZU	1K0199262AK, 1K0199262K
	<b>VW12094</b> MOTOR TAKOZU SOL VE SAĞ MOTOR TAKOZU	Yön : Sol Ve Sağ Ağırlık : 1.872 kg / 4.127 lb Not : MOTOR TAKOZU	1K0199555N
	<b>VW12097</b> MOTOR TAKOZU SOL VE SAĞ MOTOR TAKOZU	Yön : Sol Ve Sağ Ağırlık : 0.251 kg / 0.553 lb Not : MOTOR TAKOZU	1K0199868, 1K0199868A 1K0199868C, 1K0199868P 1K0199868Q
	<b>VW12110</b> MOTOR TAKOZU SOL VE SAĞ MOTOR TAKOZU	Yön : Sol Ve Sağ Ağırlık : 1.918 kg / 4.228 lb Not : MOTOR TAKOZU	1K0199262AB, 1K0199262AM 1K0199262M
	<b>VW12124</b> MOTOR TAKOZU SOL VE SAĞ	Yön : Sol Ve Sağ Ağırlık : 1.927 kg / 4.248 lb	1K0199262A, 1K0199262AA 1K0199262AS
	<b>VW12106</b> ŞANZIMAN TAKOZU SOL ŞANZUMAN TAKOZU SOL	Yön : Sol Ağırlık : 1.95 kg / 4.299 lb Not : ŞANZUMAN TAKOZU SOL	1K0199555AT, 1K0199555T

\* Bu sayfada ve katalogdaki tüm araçların adları, markaları, modelleri, sembolleri, logoları, orjinal numaraları (oe) ve diğer üçüncü parti numaraları sadece referans amaçlı kullanılmaktadır.

**LEON**
**1P1**
**2006 - 2012**







Resim	Ürün Kodu ve Açıklaması	Detay	OEM
	<b>VW12051</b> SÜSPANSİYON TAKOZU SOL VE SAĞ LASTİK DAYANAK SUSPENSİYON	Yön : Sol Ve Sağ Ağırlık : 0.045 kg / 0.099 lb Not : LASTİK DAYANAK SUSPENSİYON	1K0412303B
	<b>VW12096</b> SÜSPANSİYON TAKOZU SOL VE SAĞ SÜSPANSİYON TAKOZU	Yön : Sol Ve Sağ Ağırlık : 0.035 kg / 0.077 lb Not : SÜSPANSİYON TAKOZU	1J0412303
	<b>VW12086</b> RADYATÖR TAKOZU SOL VE SAĞ RADYATÖR ÜST LASTİĞİ	Yön : Sol Ve Sağ Ağırlık : 0.024 kg / 0.053 lb Not : RADYATÖR ÜST LASTİĞİ	1K0121367F
	<b>VW14003</b> AKS KÖRÜĞÜ +KELEPÇE+YAĞ. DIŞ	Ağırlık : 0.25 kg / 0.551 lb	1K0 498 203, 1K0498203
	<b>AU15001</b> AMORTİSÖR KÖRÜĞÜ ÖN	Şasi (Ön / Arka) : ÖN Ağırlık : 0,110 kg / 0.243 lb	6N0413175A

**LEON**
**5F**
**2012 - 2020**

Resim	Ürün Kodu ve Açıklaması	Detay	OEM
	<b>VW1014</b> ROTİL ÖN ALT SAĞ Ø15,6 RB2536	Ağırlık : 0,565 kg / 1.246 lb Konik Ölçüsü : Ø15,6 Bağlantı Delik Çapı : Ø10,5 Aşık Diş Çapı : M12X1,5	1K0407366B, 1K0407366C 1K0407366E, 5Q0407366A
	<b>VW1015</b> ROTİL ÖN ALT SOL Ø15,6 RB2537	Ağırlık : 0,565 kg / 1.246 lb Konik Ölçüsü : Ø15,6 Bağlantı Delik Çapı : Ø10,5 Aşık Diş Çapı : M12X1,5	1K0407365B, 1K0407365C 1K0407365E, 5Q0407365A
	<b>VW1031</b> ROTİL ÖN ALT SAĞ Ø15,2	Ağırlık : 0,59 kg / 1.301 lb Konik Ölçüsü : Ø15,2 Aşık Diş Çapı : M12X1,5	3C0407366B
	<b>VW1032</b> ROTİL ÖN ALT SOL Ø15,2	Ağırlık : 0,59 kg / 1.301 lb Konik Ölçüsü : Ø15,2 Aşık Diş Çapı : M12X1,5	3C0407365B
	<b>VW2008</b> ROTBAŞI ÖN SAĞ RD0342	Ağırlık : 0,412 kg / 0.908 lb Uzunluk : 95 mm / 3.74 inch Gövde Diş Çapı : M16X1,5 Aşık Diş Çapı : M12X1,5 Aşık Konik Çapı : Ø12,7	1K0423812A, 1K0423812C 1K0423812E, 1K0423812G 1K0423812J, 1K0423812K 1KD423812A

\* Bu sayfada ve katalogdaki tüm araçların adları, markaları, modelleri, sembolleri, logoları, orjinal numaraları (oe) ve diğer üçüncü parti numaraları sadece referans amaçlı kullanılmaktadır.

**LEON**
**5F**
**2012 - 2020**

Resim	Ürün Kodu ve Açıklaması	Detay	OEM
	<b>VW2009</b> ROTBAŞI ÖN SOL RD0343	Ağırlık : 0,412 kg / 0.908 lb Uzunluk : 95 mm / 3.74 inch Gövde Diş Çapı : M16X1,5 Aşık Diş Çapı : M12X1,5 Aşık Konik Çapı : Ø13,5	1K0423811A, 1K0423811C 1K0423811E, 1K0423811G 1K0423811J, 1K0423811K 1KD423811A
	<b>VW3009</b> ROTMİLİ SAĞ-SOL 310 RB2838	Ağırlık : 0,665 kg / 1.466 lb Uzunluk : 311 mm / 12.24 inch Gövde Diş Çapı : M16X1,5 Aşık Diş Çapı : M16X1,5	1K0423810A
	<b>VW20083009</b> ROT TAKIMI ÖN AKS SAĞ RB288137	Ağırlık : 1,078 kg / 2.377 lb Rotbaşı : VW2008 Rotmilî : VW3009	
	<b>VW20093009</b> ROT TAKIMI ÖN SOL RB288138	Ağırlık : 1,077 kg / 2.374 lb Rotbaşı : VW2009 Rotmilî : VW3009	
	<b>SK4005</b> Z ROT ÖM SAĞ-SOL L=335MM	Ağırlık : 0,322 kg / 0.710 lb Malzeme Türü : Metal Uzunluk : 335 mm / 13.19 inch Aşık Diş Çapı : M12X1,5	5Q0411315B
	<b>VW4014</b> Z ROT ÖN SAĞ-SOL METAL 335 RB2935	Ağırlık : 0,46 kg / 1.014 lb Malzeme Türü : Metal Uzunluk : 335 mm / 13.19 inch Aşık Diş Çapı : M12X1,5	1K0411315B, 1K0411315D 1K0411315J, 1K0411315K 1K0411315R, 5Q0411315A 5Q0411315B
	<b>VW4015</b> Z ROT SOL VE SAĞ METAL RB2937	Ağırlık : 0,373 kg / 0.822 lb Malzeme Türü : Metal Uzunluk : 95,5 mm / 3.76 inch Aşık Diş Çapı : M10X1,5	1K0505465C, 1K0505465D 1K0505465H, 1K0505465J 1K0505465K
	<b>VW4015K</b> Z ROT SOL VE SAĞ METAL	Ağırlık : 0,373 kg / 0.822 lb Malzeme Türü : Metal Uzunluk : 95,5 mm / 3.76 inch Aşık Diş Çapı : M10X1,5	1K0505465C, 1K0505465D 1K0505465H, 1K0505465J 1K0505465K
	<b>VW4031</b> Z ROT ARKA PLASTİK	Ağırlık : 0,15 kg / 0.331 lb Malzeme Türü : Plastik Uzunluk : 70 mm / 2.76 inch Aşık Diş Çapı : M10X1,5	5Q0505465A, 5Q0505465C
	<b>AU9009</b> SALINCAK ALT SOL VE SAĞ	Ağırlık : 2,910 kg / 6.415 lb Malzeme Türü : Sac Metal	5Q0505311C, 5Q0505311D
	<b>AU9012</b> SALINCAK ARKA ALT SAĞ	Ağırlık : 1,640 kg / 3.616 lb Malzeme Türü : Sac Metal	5Q0505224D

\* Bu sayfada ve katalogdaki tüm araçların adları, markaları, modelleri, sembolleri, logoları, orijinal numaraları (oe) ve diğer üçüncü parti numaraları sadece referans amaçlı kullanılmaktadır.

**LEON**
**5F**
**2012 - 2020**

Resim	Ürün Kodu ve Açıklaması	Detay	OEM
	<b>AU9013</b> SALINCAK ARKA ALT SOL	Ağırlık : 1,640 kg / 3.616 lb Malzeme Türü : Sac Metal	5Q0505223D
	<b>SK6011</b> SALINCAK ÖN ALT SAĞ RD10230	Ağırlık : 4,264 kg / 9.401 lb Malzeme Türü : Sac Metal	1K0407152B**, 1K0407152BC**
	<b>SK6011J</b> SALINCAK ÖN ALT SAĞ RD10232	Ağırlık : 3,691 kg / 8.137 lb Malzeme Türü : Sac Metal	1K0407152B, 1K0407152BC
	<b>SK6012</b> SALINCAK ÖN ALT SOL RD10231	Ağırlık : 4,264 kg / 9.401 lb Malzeme Türü : Sac Metal	1K0407151BC**, 1K0407151H**
	<b>SK6012J</b> SALINCAK ÖN ALT SOL RD10233	Ağırlık : 3,691 kg / 8.137 lb Malzeme Türü : Sac Metal	1K0407151BC, 1K0407151H
	<b>VW6079</b> SALINCAK VE DENGE KOLU ÖN ALT SAĞ SAC LEVHA	Ağırlık : 3,624 kg / 7.990 lb Malzeme Türü : Sac Metal	5Q0407152T, 81A407152C 81A407152E, 81A407152F
	<b>VW6079J</b> SALINCAK VE DENGE KOLU ÖN ALT SAĞ SAC LEVHA	Ağırlık : 3,202 kg / 7.059 lb Malzeme Türü : Sac Metal	5Q0407154E, 5WA407151A 5WA407152A
	<b>VW6080</b> SALINCAK VE DENGE KOLU ÖN ALT SOL SAC LEVHA	Ağırlık : 3,624 kg / 7.990 lb Malzeme Türü : Sac Metal	5Q0407151T, 81A407151C 81A407151E, 81A407151F
	<b>VW6080J</b> SALINCAK VE DENGE KOLU ÖN ALT SOL SAC LEVHA	Ağırlık : 3,202 kg / 7.059 lb Malzeme Türü : Sac Metal	5Q0407153E, 5WA407151A 5WA407152A
	<b>VW9001</b> SALINCAK ARKA	Ağırlık : 2,55 kg / 5.622 lb Malzeme Türü : Sac Metal	1K0505311AA, 1K0505311ABÂ 1K0505311H, 1K0505311S 1K0505311T
	<b>VW9004</b> SALINCAK ARKA	Ağırlık : 1,3 kg / 2.866 lb Malzeme Türü : Sac Metal	5Q0505323C, 5Q0505323D

\* Bu sayfada ve katalogdaki tüm araçların adları, markaları, modelleri, sembolleri, logoları, orjinal numaraları (oe) ve diğer üçüncü parti numaraları sadece referans amaçlı kullanılmaktadır.

**LEON**
**5F**
**2012 - 2020**

Resim	Ürün Kodu ve Açıklaması	Detay	OEM
	<b>VW9005</b> SALINCAK ARKA ALT ÖNDEN	Ağırlık : 0,566 kg / 1.248 lb Malzeme Türü : Sac Metal	5Q0501529C, 5Q0501529D 5Q0501529E, 5Q0501529F
	<b>AU11068</b> SALINCAK VE DENG KOLU BURCU ARKA ALT SOL VE SAĞ METAL	Şasi (Ön / Arka) : ARKA Yön : Alt Sol Ve Sağ Ağırlık : 0,201 kg / 0.443 lb Malzeme Türü : Metal	PART OF 5Q0505223D, PART OF 5Q0505224D
	<b>AU11070</b> SALINCAK VE DENG KOLU BURCU ARKA ALT	Şasi (Ön / Arka) : ARKA Yön : Alt Ağırlık : 0,100 kg / 0.220 lb	5Q0505171, 5Q0505311C 5Q0505311CSK, 5Q0505311D 5Q0505311DSK
	<b>VW11037</b> SALINCAK VE DENG KOLU BURCU SOL VE SAĞ	Yön : Sol Ve Sağ Ağırlık : 0.11 kg / 0.243 lb	1K0505279A
	<b>VW11042</b> SALINCAK VE DENG KOLU BURCU ORTA SOL VE SAĞ	Yön : Orta Sol Ve Sağ Ağırlık : 0,182 kg / 0.401 lb	1K0407182, 5Q0407182
	<b>VW11063</b> SALINCAK VE DENG KOLU BURCU SOL VE SAĞ	Yön : Sol Ve Sağ Ağırlık : 0.34 kg / 0.750 lb	5Q0407183D, 5Q0407183E
	<b>VW11075</b> SALINCAK VE DENG KOLU BURCU ARKA SOL VE SAĞ	Şasi (Ön / Arka) : ARKA Yön : Sol Ve Sağ Ağırlık : 0,870 kg / 1.918 lb Not : FORWARD and INNER	Part of 5Q0501529C, Part of 5Q0501529D Part of 5Q0501529E, Part of 5Q0501529F
	<b>VW11076</b> SALINCAK VE DENG KOLU BURCU ARKA SOL VE SAĞ	Şasi (Ön / Arka) : ARKA Yön : Sol Ve Sağ Ağırlık : 0,870 kg / 1.918 lb Not : FORWARD and OUTER	Part of 5Q0501529C, Part of 5Q0501529D Part of 5Q0501529E, Part of 5Q0501529F
	<b>VW11183</b> SALINCAK VE DENG KOLU BURCU ÖN ALT	Şasi (Ön / Arka) : ÖN Yön : Alt Ağırlık : 0,322 kg / 0.710 lb	5Q0407182F, 5Q0407183D 5Q0407183E, 5Q0407183J 5Q0407183L
	<b>VW11180</b> Z-ROT BURCU ARKA	Şasi (Ön / Arka) : ARKA Ağırlık : 0.069 kg / 0.152 lb Uzunluk : VW4015 mm / 0.00 inch Aşık Dış Çapı : VW4015K	1K0505465C*, 1K0505465D* 1K0505465H*, 1K0505465J* 1K0505465K*
	<b>VW12159</b> TAŞIYICI DESTEK BURÇLARI ARKA SOL VE SAĞ	Şasi (Ön / Arka) : ARKA Yön : Sol Ve Sağ Ağırlık : 0,130 kg / 0.287 lb	1K0505553, 1K0505553A

\* Bu sayfada ve katalogdaki tüm araçların adları, markaları, modelleri, sembolleri, logoları, orjinal numaraları (oe) ve diğer üçüncü parti numaraları sadece referans amaçlı kullanılmaktadır.

**LEON**
**5F**
**2012 - 2020**

Resim	Ürün Kodu ve Açıklaması	Detay	OEM
	<b>AU12027</b> AMORTİSÖR TAKOZU ARKA ÜST SAĞ	Şasi (Ön / Arka) : ARKA Yön : Üst Sağ Ağırlık : 0,415 kg / 0.915 lb	5Q0513353H
	<b>AU12019</b> MOTOR TAKOZU SOL VE SAĞ MOTOR TAKOZU	Yön : Sol Ve Sağ Ağırlık : 0.204 kg / 0.450 lb Malzeme Türü : Motor Takoza	5Q0198037, 5QD199867
	<b>AU12019K</b> MOTOR TAKOZU SOL VE SAĞ MOTOR TAKOZU TAKİM	Yön : Sol Ve Sağ Ağırlık : 0.408 kg / 0.899 lb Malzeme Türü : Motor Takoza Takim	5Q0198037
	<b>AU12020</b> MOTOR TAKOZU SOL VE SAĞ MOTOR TAKOZU	Yön : Sol Ve Sağ Ağırlık : 0.21 kg / 0.463 lb Malzeme Türü : Motor Takoza	5Q0198037, 5Q0199868 5QD199868
	<b>AU12022</b> MOTOR TAKOZU SOL VE SAĞ MOTOR TAKOZU	Yön : Sol Ve Sağ Ağırlık : 1.58 kg / 3.483 lb Malzeme Türü : Motor Takoza	5Q0199262, 5Q0199262BH 5Q0199262DE
	<b>AU12023</b> MOTOR TAKOZU SOL VE SAĞ MOTOR TAKOZU 7 İLERİ	Yön : Sol Ve Sağ Ağırlık : 1.58 kg / 3.483 lb Malzeme Türü : Motor Takoza Not : 7 İLERİ	5Q0199262BE, 5Q0199262BF
	<b>AU12026</b> MOTOR TAKOZU ÖN SOL VE SAĞ	Şasi (Ön / Arka) : ÖN Yön : Sol Ve Sağ Ağırlık : 0,850 kg / 1.874 lb	5Q0199855AD, 5Q0199855J 5Q0199855P, 5Q0199855Q
	<b>VW12157</b> MOTOR TAKOZU ÖN SOL VE SAĞ	Şasi (Ön / Arka) : ÖN Yön : Sol Ve Sağ Ağırlık : 2.2 kg / 4.850 lb	5Q0199555AF, 5Q0199555T 5Q0199555AP
	<b>VW12051</b> SÜSPANSİYON TAKOZU SOL VE SAĞ LASTİK DAYANAK SUSPENSİYON	Yön : Sol Ve Sağ Ağırlık : 0.045 kg / 0.099 lb Not : LASTİK DAYANAK SUSPENSİYON	1K0412303B
	<b>VW12086</b> RADYATÖR TAKOZU SOL VE SAĞ RADYATÖR ÜST LASTİĞİ	Yön : Sol Ve Sağ Ağırlık : 0.024 kg / 0.053 lb Not : RADYATÖR ÜST LASTİĞİ	1K0121367F
	<b>VW13006</b> DİREKSİYON KÖRÜĞÜ	Ağırlık : 0.145 kg / 0.320 lb	1K0423831A, 5C0423831

\* Bu sayfada ve katalogdaki tüm araçların adları, markaları, modelleri, sembolleri, logoları, orjinal numaraları (oe) ve diğer üçüncü parti numaraları sadece referans amaçlı kullanılmaktadır.

**LEON 5F 2012 - 2020**

Resim	Ürün Kodu ve Açıklaması	Detay	OEM
	<b>VW13006K</b> DİREKSİYON KÖRÜĞÜ SOL VE SAĞ 2 PİECES	Ağırlık : 0.29 kg / 0.639 lb	1K0423831A, 5C0423831

**LEON KL 2020 -**

Resim	Ürün Kodu ve Açıklaması	Detay	OEM
	<b>VW1051</b> ROTİL ALT SAĞ	Ağırlık : 0,630 kg / 1.389 lb	5Q0407366A, 5Q0407366E
	<b>VW1052</b> ROTİL ALT SOL	Ağırlık : 0,630 kg / 1.389 lb	5Q0407366E
	<b>VW2031</b> ROTBAŞI SAĞ	Ağırlık : 0,515 kg / 1.135 lb	5WA423812B, 5WA423812C 5WA423812D
	<b>VW2032</b> ROTBAŞI SOL	Ağırlık : 0,515 kg / 1.135 lb	5WA423811B, 5WA423811C 5WA423811D
	<b>VW3030</b> ROTMİLİ ÖN	Ağırlık : 0,655 kg / 1.444 lb Uzunluk : 310 mm / 12.20 inch Gövde Diş Çapı : M16X1,5 Aşık Diş Çapı : M16X1,5	5WA423810C
	<b>VW4035</b> Z ROT ARKA PLASTİK	Ağırlık : 0,165 kg / 0.364 lb Malzeme Türü : Plastik Uzunluk : 111 mm / 4.37 inch	5WA505465A
	<b>VW6079J</b> SALINCAK VE DENGE KOLU ÖN ALT SAĞ SAC LEVHA	Ağırlık : 3,202 kg / 7.059 lb Malzeme Türü : Sac Metal	5Q0407154E, 5WA407151A 5WA407152A
	<b>VW6080J</b> SALINCAK VE DENGE KOLU ÖN ALT SOL SAC LEVHA	Ağırlık : 3,202 kg / 7.059 lb Malzeme Türü : Sac Metal	5Q0407153E, 5WA407151A 5WA407152A
	<b>VW6089</b> SALINCAK VE DENGE KOLU ÖN ALT SAĞ SAC LEVHA	Ağırlık : 3,624 kg / 7.990 lb Malzeme Türü : Sac Metal	5WA407152A







\* Bu sayfada ve katalogdaki tüm araçların adları, markaları, modelleri, sembolleri, logoları, orjinal numaraları (oe) ve diğer üçüncü parti numaraları sadece referans amaçlı kullanılmaktadır.



**LEON**
**KL**
**2020 -**







Resim	Ürün Kodu ve Açıklaması	Detay	OEM
	<b>VW6090</b> SALINCAK VE DENGE KOLU ÖN ALT SOL SAC LEVHA	Ağırlık : 3,624 kg / 7.990 lb Malzeme Türü : Sac Metal	5WA407151A
	<b>VW9012</b> SALINCAK VE DENGE KOLU ARKA ALT ÖNDEN SAC LEVHA	Ağırlık : 0,675 kg / 1.488 lb Malzeme Türü : Sac Metal	5Q0501529G
	<b>VW11042</b> SALINCAK VE DENGE KOLU BURCU ORTA SOL VE SAĞ	Yön : Orta Sol Ve Sağ Ağırlık : 0,182 kg / 0.401 lb	1K0407182, 5Q0407182
	<b>VW11183</b> SALINCAK VE DENGE KOLU BURCU ÖN ALT	Şasi (Ön / Arka) : ÖN Yön : Alt Ağırlık : 0,322 kg / 0.710 lb	5Q0407182F, 5Q0407183D 5Q0407183E, 5Q0407183J 5Q0407183L

**MALAGA**
**1984 - 1994**





Resim	Ürün Kodu ve Açıklaması	Detay	OEM
	<b>FI2039</b> ROTBAŞI SAĞ-SOL RB5319	Ağırlık : 0,338 kg / 0.745 lb Uzunluk : 115 mm / 4.53 inch Gövde Diş Çapı : M12X1,5 Aşık Diş Çapı : M10X1,25 Aşık Konik Çapı : Ø12	5960036, 5960037 5960056, 7669756 SE022162406A
	<b>FI3008</b> ROTMİLİ SAĞ-SOL MANUEL 275 RB5819	Ağırlık : 0,512 kg / 1.129 lb Uzunluk : 275 mm / 10.83 inch Gövde Diş Çapı : M14X1,5 Aşık Diş Çapı : M12X1,5	022162449A, 4410145 5958244, 7633721 SE022162449A, SE022162449S
	<b>SE5001</b> SALINCAK ÖN ALT	Malzeme Türü : Dövme Çelik	21156110A, SE021156110A
	<b>SE5002</b> SALINCAK ÖN	Malzeme Türü : Dövme Çelik	SE021156110B
	<b>SE11801</b> BURÇ ORTA BURÇ KİTİ	Yön : Orta Sol Ve Sağ Ağırlık : 0,055 kg / 0.121 lb	SE13856126
	<b>VW11003</b> SALINCAK VE DENGE KOLU BURCU SOL VE SAĞ B22129	Yön : Sol Ve Sağ Ağırlık : 0,126 kg / 0.278 lb	823407181, 861407181

\* Bu sayfada ve katalogdaki tüm araçların adları, markaları, modelleri, sembolleri, logoları, orjinal numaraları (oe) ve diğer üçüncü parti numaraları sadece referans amaçlı kullanılmaktadır.

**MALAGA**
**1984 - 1994**

Resim	Ürün Kodu ve Açıklaması	Detay	OEM
	<b>FI12206</b> DİREKSİYON TAKOZU ÖN SAĞ	Şasi (Ön / Arka) : ÖN Yön : Sağ Diğer Taraf : FI12207 Ağırlık : 0,048 kg / 0.106 lb	4179802, SE127162124A
	<b>FI12206K</b> DİREKSİYON TAKOZU ÖN SAĞ KİT	Şasi (Ön / Arka) : ÖN Yön : Sağ Diğer Taraf : FI12207K Ağırlık : 0,096 kg / 0.212 lb Not : KİT	4179802, SE127162124A
	<b>FI12207</b> DİREKSİYON TAKOZU ÖN SOL	Şasi (Ön / Arka) : ÖN Yön : Sol Diğer Taraf : FI12206 Ağırlık : 0,045 kg / 0.099 lb	4169380, SE127162122A
	<b>FI12207K</b> DİREKSİYON TAKOZU ÖN SOL KİT	Şasi (Ön / Arka) : ÖN Yön : Sol Diğer Taraf : FI12206K Ağırlık : 0,090 kg / 0.198 lb Not : KİT	4169380, SE127162122A
	<b>FI13013</b> DİREKSİYON KÖRÜĞÜ SAĞ	Ağırlık : 0.1 kg / 0.220 lb	114509823, 4239459 4371156, 7583243
	<b>FI13014</b> DİREKSİYON KÖRÜĞÜ SOL	Ağırlık : 0.062 kg / 0.137 lb	114509823, 4239459 4371156, 7583243 9939039

**MALAGA**
**1994 - 1999**









Resim	Ürün Kodu ve Açıklaması	Detay	OEM
	<b>FI2039</b> ROTBAŞI SAĞ-SOL RB5319	Ağırlık : 0,338 kg / 0.745 lb Uzunluk : 115 mm / 4.53 inch Gövde Diş Çapı : M12X1,5 Aşık Diş Çapı : M10X1,25 Aşık Konik Çapı : Ø12	5960036, 5960037 5960056, 7669756 SE022162406A
	<b>FI3008</b> ROTMİLİ SAĞ-SOL MANUEL 275 RB5819	Ağırlık : 0,512 kg / 1.129 lb Uzunluk : 275 mm / 10.83 inch Gövde Diş Çapı : M14X1,5 Aşık Diş Çapı : M12X1,5	022162449A, 4410145 5958244, 7633721 SE022162449A, SE022162449S
	<b>SE5001</b> SALINCAK ÖN ALT	Malzeme Türü : Dövme Çelik	21156110A, SE021156110A
	<b>SE5002</b> SALINCAK ÖN	Malzeme Türü : Dövme Çelik	SE021156110B

\* Bu sayfada ve katalogdaki tüm araçların adları, markaları, modelleri, sembolleri, logoları, orjinal numaraları (oe) ve diğer üçüncü parti numaraları sadece referans amaçlı kullanılmaktadır.

**MALAGA**
**1994 - 1999**





Resim	Ürün Kodu ve Açıklaması	Detay	OEM
	<b>SE11801</b> BURÇ ORTA BURÇ KİTİ	Yön : Orta Sol Ve Sağ Ağırlık : 0,055 kg / 0.121 lb	SE13856126
	<b>VW11003</b> SALINCAK VE DENGE KOLU BURCU SOL VE SAĞ B22129	Yön : Sol Ve Sağ Ağırlık : 0,126 kg / 0.278 lb	823407181, 861407181

**MARBELLA**
**1986 - 1992**





Resim	Ürün Kodu ve Açıklaması	Detay	OEM
	<b>F11004</b> ROTİL ALT SAĞ+SOL RB5411	Ağırlık : 0,25 kg / 0.551 lb Konik Ölçüsü : Ø12 Aşık Dış Çapı : M10X1,25 Rotil Gövde Çapı : Ø36,8	4402644, 4402649 SE141140104A
	<b>F12012</b> ROTBAŞI SAĞ-SOL RB5313	Ağırlık : 0.53 kg / 1.168 lb	4402277, 557801103
	<b>F13021</b> ROTMİLİ SAĞ-SOL 130 RB5811	Ağırlık : 0,375 kg / 0.827 lb Uzunluk : 134 mm / 5.28 inch Gövde Dış Çapı : M14X1,5 Aşık Dış Çapı : M14X1	4219839, 4254520 4318635, 4318655 4361667
	<b>F15003</b> SALINCAK ÖN	Malzeme Türü : Dövme Çelik	4402672, 7601261 SE141156110A
	<b>F16003</b> SALINCAK ÖN	Ağırlık : 1,424 kg / 3.139 lb Malzeme Türü : Sac Metal	4408138, 5995503 SE028140104A*, SE028140104A
	<b>F111017</b> SALINCAK VE DENGE KOLU BURCU ÖN SOL VE SAĞ	Şasi (Ön / Arka) : ÖN Yön : Sol Ve Sağ Ağırlık : 0,185 kg / 0.408 lb	4157013
	<b>F112206</b> DİREKSİYON TAKOZU ÖN SAĞ	Şasi (Ön / Arka) : ÖN Yön : Sağ Diğer Taraf : F112207 Ağırlık : 0,048 kg / 0.106 lb	4179802, SE127162124A
	<b>F112206K</b> DİREKSİYON TAKOZU ÖN SAĞ KİT	Şasi (Ön / Arka) : ÖN Yön : Sağ Diğer Taraf : F112207K Ağırlık : 0,096 kg / 0.212 lb Not : KİT	4179802, SE127162124A

\* Bu sayfada ve katalogdaki tüm araçların adları, markaları, modelleri, sembolleri, logoları, orijinal numaraları (oe) ve diğer üçüncü parti numaraları sadece referans amaçlı kullanılmaktadır.

**MARBELLA**
**1986 - 1992**

Resim	Ürün Kodu ve Açıklaması	Detay	OEM
	<b>FI12207</b> DİREKSİYON TAKOZU ÖN SOL	Şasi (Ön / Arka) : ÖN Yön : Sol Diğer Taraf : FI12206 Ağırlık : 0,045 kg / 0.099 lb	4169380, SE127162122A
	<b>FI12207K</b> DİREKSİYON TAKOZU ÖN SOL KİT	Şasi (Ön / Arka) : ÖN Yön : Sol Diğer Taraf : FI12206K Ağırlık : 0,090 kg / 0.198 lb Not : KİT	4169380, SE127162122A
	<b>FI13013</b> DİREKSİYON KÖRÜĞÜ SAĞ	Ağırlık : 0.1 kg / 0.220 lb	114509823, 4239459 4371156, 7583243
	<b>FI13014</b> DİREKSİYON KÖRÜĞÜ SOL	Ağırlık : 0.062 kg / 0.137 lb	114509823, 4239459 4371156, 7583243 9939039
	<b>FI14003</b> AKS KÖRÜĞÜ +KELEPÇE+YAĞ. İÇ BİLYALI Ø23	Ağırlık : 0.301 kg / 0.664 lb	46307085, 46307657 556001106, 7625541 BD145531

**MARBELLA**
**1992 - 1998**







Resim	Ürün Kodu ve Açıklaması	Detay	OEM
	<b>FI1004</b> ROTİL ALT SAĞ+SOL RB5411	Ağırlık : 0,25 kg / 0.551 lb Konik Ölçüsü : Ø12 Aşık Diş Çapı : M10X1,25 Rotil Gövde Çapı : Ø36,8	4402644, 4402649 SE141140104A
	<b>FI2013</b> ROTBAŞI ÖN SAĞ - SOL RB5314	Ağırlık : 0,291 kg / 0.642 lb Uzunluk : 89 mm / 3.50 inch Gövde Diş Çapı : M12X1,5 Aşık Diş Çapı : M10X1,25 Aşık Konik Çapı : Ø12	5960834, 5960835 SE141162410A
	<b>FI3022</b> ROTMİLİ ÖN SAĞ - SOL 192	Ağırlık : 0,397 kg / 0.875 lb Uzunluk : 192 mm / 7.56 inch Gövde Diş Çapı : M14X1,5 Aşık Diş Çapı : M12X1,5	5960321, SE141162449A
	<b>FI5003</b> SALINCAK ÖN	Malzeme Türü : Dövme Çelik	4402672, 7601261 SE141156110A
	<b>FI11017</b> SALINCAK VE DENGE KOLU BURCU ÖN SOL VE SAĞ	Şasi (Ön / Arka) : ÖN Yön : Sol Ve Sağ Ağırlık : 0,185 kg / 0.408 lb	4157013

\* Bu sayfada ve katalogdaki tüm araçların adları, markaları, modelleri, sembolleri, logoları, orjinal numaraları (oe) ve diğer üçüncü parti numaraları sadece referans amaçlı kullanılmaktadır.

**MARBELLA**
**1992 - 1998**

Resim	Ürün Kodu ve Açıklaması	Detay	OEM
	<b>FI12206</b> DİREKSİYON TAKOZU ÖN SAĞ	Şasi (Ön / Arka) : ÖN Yön : Sağ Diğer Taraf : FI12207 Ağırlık : 0,048 kg / 0.106 lb	4179802, SE127162124A
	<b>FI12206K</b> DİREKSİYON TAKOZU ÖN SAĞ KİT	Şasi (Ön / Arka) : ÖN Yön : Sağ Diğer Taraf : FI12207K Ağırlık : 0,096 kg / 0.212 lb Not : KİT	4179802, SE127162124A
	<b>FI12207</b> DİREKSİYON TAKOZU ÖN SOL	Şasi (Ön / Arka) : ÖN Yön : Sol Diğer Taraf : FI12206 Ağırlık : 0,045 kg / 0.099 lb	4169380, SE127162122A
	<b>FI12207K</b> DİREKSİYON TAKOZU ÖN SOL KİT	Şasi (Ön / Arka) : ÖN Yön : Sol Diğer Taraf : FI12206K Ağırlık : 0,090 kg / 0.198 lb Not : KİT	4169380, SE127162122A

**Mii**
**KF1**
**2011 - 2021**

Resim	Ürün Kodu ve Açıklaması	Detay	OEM
	<b>SK1025</b> ROTİL SAĞ	Ağırlık : 0,59 kg / 1.301 lb Konik Ölçüsü : Ø15 Bağlantı Delik Çapı : Ø10,5 Aşık Dış Çapı : M12X1,5	5U0407366A, 6R0407366 6R0407366A, 6R0407366B
	<b>SK1026</b> ROTİL ÖN ALT SOL Ø15	Ağırlık : 0,59 kg / 1.301 lb Konik Ölçüsü : Ø15 Bağlantı Delik Çapı : Ø10,5 Aşık Dış Çapı : M12X1,5	5U0407365A, 6R0407365 6R0407365A, 6R0407365B
	<b>VW2024</b> ROTBAŞI SAĞ 94 MM	Ağırlık : 0,435 kg / 0.959 lb Uzunluk : 93,5 mm / 3.68 inch Gövde Dış Çapı : M14X1,5 Aşık Dış Çapı : M12X1,5 Aşık Konik Çapı : Ø13,4	1S0423812A
	<b>VW2025</b> ROTBAŞI SOL 94 MM	Ağırlık : 0,435 kg / 0.959 lb Uzunluk : 93,5 mm / 3.68 inch Gövde Dış Çapı : M14X1,5 Aşık Dış Çapı : M12X1,5 Aşık Konik Çapı : Ø13,4	1S0423811A
	<b>VW3020</b> ROTMİLİ SAĞ-SOL <<ÖZELLİK>> 306MM	Ağırlık : 0,576 kg / 1.270 lb Uzunluk : 306 mm / 12.05 inch Gövde Dış Çapı : M14X1,5 Aşık Dış Çapı : M14X1,5	1S0423810A
	<b>VW20243020</b> ROT TAKIMI ÖN SAĞ	Ağırlık : 1,1 kg / 2.425 lb Rotbaşı : VW2024 Rotmili : VW3020	1S0423810A S1, 1S0423810A

\* Bu sayfada ve katalogdaki tüm araçların adları, markaları, modelleri, sembolleri, logoları, orjinal numaraları (oe) ve diğer üçüncü parti numaraları sadece referans amaçlı kullanılmaktadır.

Mii	KF1	2011 - 2021	
Resim	Ürün Kodu ve Açıklaması	Detay	OEM
	<b>VW20253020</b> ROT TAKIMI ÖN SOL	Ağırlık : 1,1 kg / 2.425 lb Rotbaşı : VW2024 Rotmili : VW3020	1S0423810A S2, 1S0423810A
	<b>AU4028</b> Z ROT ÖN	Ağırlık : 0,368 kg / 0.811 lb Malzeme Türü : Metal Uzunluk : 270 mm / 10.63 inch Aşık Diş Çapı : M10X1,5	6Q0411315L, 6Q0411315N 8Z0411315D
	<b>SK4001</b> Z ROT ÖN METAL	Ağırlık : 0,357 kg / 0.787 lb Malzeme Türü : Metal Uzunluk : 270 mm / 10.63 inch Aşık Diş Çapı : M10X1,5	2Q0411315, 2Q0411315A 6Q0411315A, 6Q0411315E 6Q0411315F, 6Q0411315H 6Q0411315J, 6Q0411315M 6Q0411315P
	<b>VW6047</b> SALINCAK ÖN SAĞ	Ağırlık : 2,65 kg / 5.842 lb Malzeme Türü : Sac Metal	1S0407152*
	<b>VW6047J</b> SALINCAK ÖN SAĞ	Ağırlık : 2,06 kg / 4.542 lb Malzeme Türü : Sac Metal	1S0407152
	<b>VW6048</b> SALINCAK ÖN SOL	Ağırlık : 2,65 kg / 5.842 lb Malzeme Türü : Sac Metal	1S0407151*
	<b>VW6048J</b> SALINCAK ÖN SOL	Ağırlık : 2,06 kg / 4.542 lb Malzeme Türü : Sac Metal	1S0407151
	<b>AU11002</b> SALINCAK VE DENGE KOLU BURCU ÖN SOL VE SAĞ B22117	Şasi (Ön / Arka) : ÖN Yön : Sol Ve Sağ Ağırlık : 0,108 kg / 0.238 lb	1J0407181, 1J0407181A
	<b>AU11005</b> SALINCAK VE DENGE KOLU BURCU ÖN ORTA SOL VE SAĞ B40115	Şasi (Ön / Arka) : ÖN Yön : Orta Sol Ve Sağ Ağırlık : 0,111 kg / 0.245 lb Not : VW6014 - VW60614J	191407182, 357407182 357407182F
	<b>SK12004</b> TORSİYON BURCU ARKA SOL VE SAĞ	Şasi (Ön / Arka) : ARKA Yön : Sol Ve Sağ Ağırlık : 0,335 kg / 0.739 lb	1S0501541B, 1S0501541F
	<b>VW12050</b> VİRAJ DEMİR LASTİĞİ SOL VE SAĞ RUBBER	Şasi (Ön / Arka) : ÖN Yön : Sol Ve Sağ Ağırlık : 0.04 kg / 0.088 lb Malzeme Türü : Rubber Not : VİRAJ LASTİĞİ	6Q0411314P

\* Bu sayfada ve katalogdaki tüm araçların adları, markaları, modelleri, sembolleri, logoları, orjinal numaraları (oe) ve diğer üçüncü parti numaraları sadece referans amaçlı kullanılmaktadır.

**Mii KF1 2011 - 2021**









Resim	Ürün Kodu ve Açıklaması	Detay	OEM
	<b>VW12050K</b> VİRAJ DEMİR LASTİĞİ SOL VE SAĞ RUBBER	Şasi (Ön / Arka) : ÖN Yön : Sol Ve Sağ Ağırlık : 0.08 kg / 0.176 lb Malzeme Türü : Rubber Not : VİRAJ LASTİĞİ (İKİLİ)	6Q0411314P*, 6Q0411314P
	<b>VW12061</b> AMORTİSÖR TAKOZU SOL VE SAĞ AMORTİSÖR TAKOZU	Yön : Sol Ve Sağ Ağırlık : 0.27 kg / 0.595 lb Not : AMORTİSÖR TAKOZU	1H0412365A, 1J0412249 1J0412331BS, 1J0412331C
	<b>VW12061A</b> AMORTİSÖR TAKOZU SOL VE SAĞ AMORTİSÖR RULMANI	Yön : Sol Ve Sağ Ağırlık : 0.08 kg / 0.176 lb Not : AMORTİSÖR RULMANI	1J0412249, 1J0412249C 357412249, 357412249A 4503300051, 7201688 7201848, 95VW3K031AA
	<b>VW12061K</b> AMORTİSÖR TAKOZU SOL VE SAĞ 2 PCS	Yön : Sol Ve Sağ Ağırlık : 0.7 kg / 1.543 lb Not : 2 PCS	1H0412365A, 1J0412249 1J0412331BS, 1J0412331C
	<b>VW12103</b> AMORTİSÖR TAKOZU SOL VE SAĞ AMORTİSÖR ÜST TAKOZU	Yön : Sol Ve Sağ Ağırlık : 0.23 kg / 0.507 lb Not : AMORTİSÖR ÜST TAKOZU	1J0412331B, 1J0412331C
	<b>SE12006</b> ŞANZİMAN TAKOZU SOL	Yön : Sol Ağırlık : 0,760 kg / 1.676 lb	1S0199555A
	<b>VW12036</b> SÜSPANSİYON TAKOZU SOL VE SAĞ ARKA SUSPANSİYON TAKOZU	Yön : Sol Ve Sağ Ağırlık : 1.591 kg / 3.508 lb Not : ARKA SUSPANSİYON TAKOZU	6Q0512131B
	<b>VW12086</b> RADYATÖR TAKOZU SOL VE SAĞ RADYATÖR ÜST LASTİĞİ	Yön : Sol Ve Sağ Ağırlık : 0.024 kg / 0.053 lb Not : RADYATÖR ÜST LASTİĞİ	1K0121367F

**RONDA 1982 - 1988**

Resim	Ürün Kodu ve Açıklaması	Detay	OEM
	<b>F12039</b> ROTBAŞI SAĞ-SOL RB5319	Ağırlık : 0,338 kg / 0.745 lb Uzunluk : 115 mm / 4.53 inch Gövde Dış Çapı : M12X1,5 Aşık Dış Çapı : M10X1,25 Aşık Konik Çapı : Ø12	5960036, 5960037 5960056, 7669756 SE022162406A
	<b>F13022</b> ROTMİLİ ÖN SAĞ - SOL 192	Ağırlık : 0,397 kg / 0.875 lb Uzunluk : 192 mm / 7.56 inch Gövde Dış Çapı : M14X1,5 Aşık Dış Çapı : M12X1,5	5960321, SE141162449A

\* Bu sayfada ve katalogdaki tüm araçların adları, markaları, modelleri, sembolleri, logoları, orjinal numaraları (oe) ve diğer üçüncü parti numaraları sadece referans amaçlı kullanılmaktadır.

**RONDA**
**1982 - 1988**

Resim	Ürün Kodu ve Açıklaması	Detay	OEM
	<b>FI5614</b> SALINCAK ÖN RB5614	Malzeme Türü : Dövme Çelik	4402360, 4402361 7535188, 7558962 SE138156110A
	<b>FI11039</b> SALINCAK VE DENGE KOLU BURCU ÖN SOL VE SAĞ B25145	Şasi (Ön / Arka) : ÖN Yön : Sol Ve Sağ Ağırlık : 0,044 kg / 0.097 lb	4332457 â PART OF, 4402360 PART OF 7558961
	<b>FI12206</b> DİREKSİYON TAKOZU ÖN SAĞ	Şasi (Ön / Arka) : ÖN Yön : Sağ Diğer Taraf : FI12207 Ağırlık : 0,048 kg / 0.106 lb	4179802, SE127162124A
	<b>FI12206K</b> DİREKSİYON TAKOZU ÖN SAĞ KİT	Şasi (Ön / Arka) : ÖN Yön : Sağ Diğer Taraf : FI12207K Ağırlık : 0,096 kg / 0.212 lb Not : KİT	4179802, SE127162124A
	<b>FI12207</b> DİREKSİYON TAKOZU ÖN SOL	Şasi (Ön / Arka) : ÖN Yön : Sol Diğer Taraf : FI12206 Ağırlık : 0,045 kg / 0.099 lb	4169380, SE127162122A
	<b>FI12207K</b> DİREKSİYON TAKOZU ÖN SOL KİT	Şasi (Ön / Arka) : ÖN Yön : Sol Diğer Taraf : FI12206K Ağırlık : 0,090 kg / 0.198 lb Not : KİT	4169380, SE127162122A
	<b>FI13014</b> DİREKSİYON KÖRÜĞÜ SOL	Ağırlık : 0.062 kg / 0.137 lb	114509823, 4239459 4371156, 7583243 9939039
	<b>FI15005</b> AMORTİSÖR KÖRÜĞÜ ÖN	Şasi (Ön / Arka) : ÖN Ağırlık : 0,149 kg / 0.328 lb	5978771





**TARRACO**
**KN2**
**2018 -**

Resim	Ürün Kodu ve Açıklaması	Detay	OEM
	<b>SK9002</b> SALINCAK ALT SOL VE SAĞ	Ağırlık : 2,914 kg / 6.424 lb Malzeme Türü : Sac Metal	3Q0505311C, 3Q0505311D 3Q0505311E
	<b>SK11006</b> SALINCAK VE DENGE KOLU BURCU ARKA ALT	Şasi (Ön / Arka) : ARKA Yön : Alt Ağırlık : 0,125 kg / 0.276 lb	3Q0505311C*, 3Q0505311D* 3Q0505311E*, 5Q0505171B*





\* Bu sayfada ve katalogdaki tüm araçların adları, markaları, modelleri, sembolleri, logoları, orjinal numaraları (oe) ve diğer üçüncü parti numaraları sadece referans amaçlı kullanılmaktadır.



**TERRA**
**1984 - 1990**



Resim	Ürün Kodu ve Açıklaması	Detay	OEM
	<b>FI2038</b> ROTBAŞI SAĞ-SOL RB5318	Ağırlık : 0,43 kg / 0.948 lb Uzunluk : 115 mm / 4.53 inch Gövde Diş Çapı : M14X1,5 Aşık Diş Çapı : M10X1,25 Aşık Konik Çapı : Ø12	4410145, 4410415
	<b>FI2039</b> ROTBAŞI SAĞ-SOL RB5319	Ağırlık : 0,338 kg / 0.745 lb Uzunluk : 115 mm / 4.53 inch Gövde Diş Çapı : M12X1,5 Aşık Diş Çapı : M10X1,25 Aşık Konik Çapı : Ø12	5960036, 5960037 5960056, 7669756 SE022162406A
	<b>FI3008</b> ROTMİLİ SAĞ-SOL MANUEL 275 RB5819	Ağırlık : 0,512 kg / 1.129 lb Uzunluk : 275 mm / 10.83 inch Gövde Diş Çapı : M14X1,5 Aşık Diş Çapı : M12X1,5	022162449A, 4410145 5958244, 7633721 SE022162449A, SE022162449S
	<b>FI5614</b> SALINCAK ÖN RB5614	Malzeme Türü : Dövme Çelik	4402360, 4402361 7535188, 7558962 SE138156110A
	<b>FI11039</b> SALINCAK VE DENGE KOLU BURCU ÖN SOL VE SAĞ B25145	Şasi (Ön / Arka) : ÖN Yön : Sol Ve Sağ Ağırlık : 0,044 kg / 0.097 lb	4332457 a φPART OF, 4402360 PART OF 7558961

**TERRA**
**1990 - 1994**



Resim	Ürün Kodu ve Açıklaması	Detay	OEM
	<b>OP1516</b> ROTİL ALT SAĞ-SOL RC1516	Ağırlık : 0,595 kg / 1.312 lb Konik Ölçüsü : Ø13,3 Bağlantı Delik Çapı : Ø10,5 Aşık Diş Çapı : M12X1,5	16003164, 1603120 1603164, 90140407 90375505, 94786917 94788122
	<b>OP2006</b> ROTBAŞI ÖN SOL RC1313	Ağırlık : 0,378 kg / 0.833 lb Uzunluk : 65 mm / 2.56 inch Gövde Diş Çapı : M16X1,5 Aşık Diş Çapı : M12X1,5 Aşık Konik Çapı : Ø13	26001807, 2601807 26023685, 322125 324039, 7846495 7848281, 90125567 90135948, 90140007
	<b>OP2007</b> ROTBAŞI ÖN SAĞ RC1312	Ağırlık : 0,372 kg / 0.820 lb Uzunluk : 65 mm / 2.56 inch Gövde Diş Çapı : M16X1,5 Aşık Diş Çapı : M12X1,5 Aşık Konik Çapı : Ø13	26001806, 322126 324038, 7846485 7848282, 90125568 90135947, 90140006 94638747, 96275019
	<b>FI5003</b> SALINCAK ÖN	Malzeme Türü : Dövme Çelik	4402672, 7601261 SE141156110A
	<b>FI6003</b> SALINCAK ÖN	Ağırlık : 1,424 kg / 3.139 lb Malzeme Türü : Sac Metal	4408138, 5995503 SE028140104A*, SE028140104A

\* Bu sayfada ve katalogdaki tüm araçların adları, markaları, modelleri, sembolleri, logoları, orjinal numaraları (oe) ve diğer üçüncü parti numaraları sadece referans amaçlı kullanılmaktadır.

**TERRA**
**1990 - 1994**











Resim	Ürün Kodu ve Açıklaması	Detay	OEM
	<b>FI12206</b> DİREKSİYON TAKOZU ÖN SAĞ	Şasi (Ön / Arka) : ÖN Yön : Sağ Diğer Taraf : FI12207 Ağırlık : 0,048 kg / 0.106 lb	4179802, SE127162124A
	<b>FI12206K</b> DİREKSİYON TAKOZU ÖN SAĞ KİT	Şasi (Ön / Arka) : ÖN Yön : Sağ Diğer Taraf : FI12207K Ağırlık : 0,096 kg / 0.212 lb Not : KİT	4179802, SE127162124A
	<b>FI12207</b> DİREKSİYON TAKOZU ÖN SOL	Şasi (Ön / Arka) : ÖN Yön : Sol Diğer Taraf : FI12206 Ağırlık : 0,045 kg / 0.099 lb	4169380, SE127162122A
	<b>FI12207K</b> DİREKSİYON TAKOZU ÖN SOL KİT	Şasi (Ön / Arka) : ÖN Yön : Sol Diğer Taraf : FI12206K Ağırlık : 0,090 kg / 0.198 lb Not : KİT	4169380, SE127162122A
	<b>FI14001</b> AKS KÖRÜĞÜ +KELEPÇE+YAĞ. İÇ SEGMANLI	Ağırlık : 0.304 kg / 0.670 lb	46307644, 7625541
	<b>FI14003</b> AKS KÖRÜĞÜ +KELEPÇE+YAĞ. İÇ BİLYALI Ø23	Ağırlık : 0.301 kg / 0.664 lb	46307085, 46307657 556001106, 7625541 BD145531
	<b>FI14007</b> AKS KÖRÜĞÜ +KELEPÇE+YAĞ. DIŞ	Ağırlık : 0.301 kg / 0.664 lb	46307085, 46308338 7625541

**TOLEDO**
**I 1 L**
**1993 - 1999**

Resim	Ürün Kodu ve Açıklaması	Detay	OEM
	<b>VW1012</b> ROTİL ALT SOL VE SAĞ	Ağırlık : 0,353 kg / 0.778 lb Bağlantı Delik Çapı : Ø8,5	357407365, 357407365A
	<b>VW1012K</b> ROTİL ALT SAĞ-SOL 19 RD0515	Ağırlık : 0,445 kg / 0.981 lb Bağlantı Delik Çapı : Ø8,5	357407365, 357407365A* 357407365A, 357407365S 357407365-S1
	<b>VW1013</b> ROTİL ÖN ALT Ø16,5 RD0519	Ağırlık : 0,415 kg / 0.915 lb Konik Ölçüsü : Ø16,5 Bağlantı Delik Çapı : Ø8,5 Aşık Diş Çapı : M12X1,5	1H0407365

\* Bu sayfada ve katalogdaki tüm araçların adları, markaları, modelleri, sembolleri, logoları, orijinal numaraları (oe) ve diğer üçüncü parti numaraları sadece referans amaçlı kullanılmaktadır.

**TOLEDO**
**I 1L**
**1993 - 1999**

Resim	Ürün Kodu ve Açıklaması	Detay	OEM
	<b>VW1013K</b> ROTİL	Ağırlık : 0,495 kg / 1.091 lb Konik Ölçüsü : Ø16,5 Bağlantı Delik Çapı : Ø8,5 Aşık Dış Çapı : M12X1,5	1H0407365*, 1H0407365
	<b>SE2003</b> ROTBAŞI SAĞ	Ağırlık : 0,37 kg / 0.816 lb Uzunluk : 92 mm / 3.62 inch Gövde Dış Çapı : M14X1,5 Aşık Dış Çapı : M12X1,5 Aşık Konik Çapı : Ø12,6	1J0422812E, 3A0422812 3A0422812A
	<b>SE2004</b> ROTBAŞI SOL	Ağırlık : 0,37 kg / 0.816 lb Uzunluk : 92 mm / 3.62 inch Gövde Dış Çapı : M14X1,5 Aşık Dış Çapı : M12X1,5 Aşık Konik Çapı : Ø12,6	1J0422811E, 3A0422811 3A0422811A
	<b>SE3002</b> ROTMİLİ SOL VE SAĞ 318	Ağırlık : 0,578 kg / 1.274 lb Uzunluk : 318 mm / 12.52 inch	6K0422803D, 6K0422804D 6K0422807D
	<b>VW3003</b> ROTMİLİ SAĞ-SOL RD0817	Ağırlık : 0,678 kg / 1.495 lb Uzunluk : 340 mm / 13.39 inch Gövde Dış Çapı : M22X1,5 Aşık Dış Çapı : M14X1,5	191419721, 191419803 191419803-PART, 191419804* 191419804, 191419807A 191419821
	<b>VW3004</b> ROTMİLİ ÖN SAĞ - SOL 338 RD0887	Ağırlık : 0,605 kg / 1.334 lb Uzunluk : 338 mm / 13.31 inch Gövde Dış Çapı : M14X1,5 Aşık Dış Çapı : M14X1,5	191407153, 191422721 191422803A, 191422804A 191422807, 191422807A 191422821, 191422821A 6K0422821
	<b>SE20033002</b> ROT TAKIMI ÖN AKS SAĞ	Ağırlık : 0,96 kg / 2.116 lb Rotbaşı : SE2003 Rotmilî : SE3002	6K0422804A, 6K0422804D
	<b>SE20043002</b> ROT TAKIMI ÖN AKS SOL	Ağırlık : 0,96 kg / 2.116 lb Rotbaşı : SE2004 Rotmilî : SE3002	6K0422803A, 6K0422803D
	<b>VW20063003</b> ROT TAKIMI SAĞ RD088116	Ağırlık : 0,984 kg / 2.169 lb Rotbaşı : VW2006 Rotmilî : VW3003	191419804, 191419804A
	<b>VW20063004</b> ROT TAKIMI ÖN AKS SAĞ	Ağırlık : 0,991 kg / 2.185 lb Rotbaşı : VW2006 Rotmilî : VW3004	191422804A
	<b>VW20073003</b> ROT TAKIMI SOL RD088115	Ağırlık : 0,978 kg / 2.156 lb Rotbaşı : VW2007 Rotmilî : VW3003	191419803, 191419803A

\* Bu sayfada ve katalogdaki tüm araçların adları, markaları, modelleri, sembolleri, logoları, orjinal numaraları (oe) ve diğer üçüncü parti numaraları sadece referans amaçlı kullanılmaktadır.

**TOLEDO**
**I 1L**
**1993 - 1999**

Resim	Ürün Kodu ve Açıklaması	Detay	OEM
	<b>VW20073004</b> ROT TAKIMI SOL RD088118	Ağırlık : 0,991 kg / 2.185 lb Rotbaşı : VW2007 Rotmilisi : VW3004	191422803, 191422803A
	<b>VW4004</b> Z ROT ÖN SAĞ - SOL KOMPLE RD0942	Ağırlık : 0,189 kg / 0.417 lb Malzeme Türü : Komple Uzunluk : 75 mm / 2.95 inch	191411315, 191411315B 191411315BKIT, 191411315BS
	<b>VW4008</b> Z ROT ÖN SAĞ - SOL METAL RD0923	Ağırlık : 0,166 kg / 0.366 lb Malzeme Türü : Metal Uzunluk : 77 mm / 3.03 inch Aşık Diş Çapı : M8X1,25	191411315A, 191411315B 191411315BK
	<b>VW6004J</b> SALINCAK ÖN RD1103	Ağırlık : 2,605 kg / 5.743 lb Malzeme Türü : Sac Metal	191.407.151B, 191407151A 191407151B
	<b>VW6006</b> SALINCAK ÖN SAĞ RD1019	Ağırlık : 3,166 kg / 6.980 lb Malzeme Türü : Sac Metal	191407151B, 191407175 191411315B, 191411331 357407365A, 6N0411329 N0111849, N10127702
	<b>VW60066007K</b> SALINCAK ÖN	Ağırlık : 3.3 kg / 7.275 lb Malzeme Türü : Sac Metal	
	<b>VW600674008K</b> SALINCAK ÖN	Ağırlık : 3.466 kg / 7.641 lb Malzeme Türü : Sac Metal	
	<b>VW6007</b> SALINCAK ÖN SOL RD1029	Ağırlık : 3,088 kg / 6.808 lb Malzeme Türü : Sac Metal	191407151A
	<b>VW6014</b> SALINCAK ÖN SAĞ RD1021	Ağırlık : 3,966 kg / 8.744 lb Malzeme Türü : Sac Metal	1H0407152*
	<b>VW6014J</b> SALINCAK ÖN SAĞ RD1106	Ağırlık : 3,35 kg / 7.385 lb Malzeme Türü : Sac Metal	1H0407152
	<b>VW6015</b> SALINCAK ÖN SOL RD1022	Ağırlık : 3,674 kg / 8.100 lb Malzeme Türü : Sac Metal	1H0407151A *, 1H0407151A*

\* Bu sayfada ve katalogdaki tüm araçların adları, markaları, modelleri, sembolleri, logoları, orijinal numaraları (oe) ve diğer üçüncü parti numaraları sadece referans amaçlı kullanılmaktadır.

**TOLEDO**
**I 1L**
**1993 - 1999**

Resim	Ürün Kodu ve Açıklaması	Detay	OEM
	<b>VW6015J</b> SALINCAK ÖN SOL RD1105	Ağırlık : 3,152 kg / 6.949 lb Malzeme Türü : Sac Metal	1H0.407.151A, 1H0407151 1H0407151A
	<b>AU11005</b> SALINCAK VE DENGE KOLU BURCU ÖN ORTA SOL VE SAĞ B40115	Şasi (Ön / Arka) : ÖN Yön : Orta Sol Ve Sağ Ağırlık : 0,111 kg / 0.245 lb Not : VW6014 - VW60614J	191407182, 357407182 357407182F
	<b>AU11035</b> SALINCAK VE DENGE KOLU BURCU ARKA SOL VE SAĞ	Şasi (Ön / Arka) : ARKA Yön : Sol Ve Sağ Ağırlık : 0,25 kg / 0.551 lb	1K0505171C
	<b>VW11001</b> SALINCAK VE DENGE KOLU BURCU SOL VE SAĞ B40114	Yön : Sol Ve Sağ Ağırlık : 0.141 kg / 0.311 lb	191407181D, 191407181E 357407181
	<b>VW11036</b> SALINCAK VE DENGE KOLU BURCU SOL VE SAĞ	Yön : Sol Ve Sağ Ağırlık : 0.07 kg / 0.154 lb Not : BORUSU	191411315B, 4A0399413A
	<b>VW11840</b> BURÇ	Yön : Sol Ve Sağ Ağırlık : 0,149 kg / 0.328 lb	357407181
	<b>VW12012</b> BEŞİK (TRAVERS) BURCU ARKA SOL VE SAĞ	Şasi (Ön / Arka) : ARKA Yön : Sol Ve Sağ Ağırlık : 0,63 kg / 1.389 lb	1H0501541A
	<b>VW12012K</b> BEŞİK (TRAVERS) BURCU ARKA SOL VE SAĞ	Şasi (Ön / Arka) : ARKA Yön : Sol Ve Sağ Ağırlık : 1,260 kg / 2.778 lb	1H0501541A
	<b>VW12013</b> BEŞİK (TRAVERS) BURCU ARKA SOL VE SAĞ	Şasi (Ön / Arka) : ARKA Yön : Sol Ve Sağ Ağırlık : 1,380 kg / 3.042 lb	1H0501541A
	<b>VW12060</b> TORSİYON BURCU SOL VE SAĞ	Yön : Sol Ve Sağ Ağırlık : 0,459 kg / 1.012 lb	191501541
	<b>VW12037</b> VİRAJ DEMİR LASTİĞİ SOL VE SAĞ RUBBER	Şasi (Ön / Arka) : ÖN Yön : Sol Ve Sağ Ağırlık : 0.11 kg / 0.243 lb Malzeme Türü : Rubber Not : VİRAJ DEMİR LASTİĞİ ÖN	191411314

\* Bu sayfada ve katalogdaki tüm araçların adları, markaları, modelleri, sembolleri, logoları, orjinal numaraları (oe) ve diğer üçüncü parti numaraları sadece referans amaçlı kullanılmaktadır.

**TOLEDO**
**I 1L**
**1993 - 1999**

Resim	Ürün Kodu ve Açıklaması	Detay	OEM
	<b>VW12037K</b> VİRAJ DEMİR LASTİĞİ SOL VE SAĞ RUBBER	Şasi (Ön / Arka) : ÖN Yön : Sol Ve Sağ Ağırlık : 0.22 kg / 0.485 lb Malzeme Türü : Rubber	191411314*
	<b>VW12111</b> VİRAJ DEMİR LASTİĞİ SOL VE SAĞ RUBBER	Şasi (Ön / Arka) : ÖN Yön : Sol Ve Sağ Ağırlık : 0.015 kg / 0.033 lb Malzeme Türü : Rubber Not : VİRAJ LASTİĞİ	191411329, 6N0411329
	<b>VW12111K</b> VİRAJ DEMİR LASTİĞİ SOL VE SAĞ RUBBER	Şasi (Ön / Arka) : ÖN Yön : Sol Ve Sağ Ağırlık : 0.03 kg / 0.066 lb Malzeme Türü : Rubber	191411329*, 6N0411329*
	<b>VW12001</b> AMORTİSÖR TAKOZU SOL VE SAĞ AMORTİSÖR TAKOZU	Yön : Sol Ve Sağ Ağırlık : 0.644 kg / 1.420 lb Not : AMORTİSÖR TAKOZU	176412329, 191412329 191412331
	<b>VW12005</b> AMORTİSÖR TAKOZU SOL VE SAĞ AMORTİSÖR ÜST TAKOZU	Yön : Sol Ve Sağ Ağırlık : 0.1 kg / 0.220 lb Not : AMORTİSÖR ÜST TAKOZU	191512333
	<b>VW12006</b> AMORTİSÖR TAKOZU SOL VE SAĞ AMORTİSÖR ÜST TAKOZU	Yön : Sol Ve Sağ Ağırlık : 0.445 kg / 0.981 lb Not : AMORTİSÖR ÜST TAKOZU	357412331A, 7201848 7M0412331, 95VW3K031AA
	<b>VW12065</b> AMORTİSÖR TAKOZU SOL VE SAĞ AMORTİSÖR KEPİ	Yön : Sol Ve Sağ Ağırlık : 0.377 kg / 0.831 lb Not : AMORTİSÖR KEPİ	191 512 113, 191512113
	<b>VW12065K</b> AMORTİSÖR TAKOZU ÖN SOL VE SAĞ 2 PCS	Şasi (Ön / Arka) : ÖN Yön : Sol Ve Sağ Ağırlık : 0.758 kg / 1.671 lb Not : 2 PCS	191512113
	<b>VW12007</b> MOTOR TAKOZU SAĞ MOTOR TAKOZU SAĞ	Yön : Sağ Ağırlık : 1.193 kg / 2.630 lb Not : MOTOR TAKOZU SAĞ	91199262A
	<b>VW12008</b> MOTOR TAKOZU SOL VE SAĞ MOTOR TAKOZU	Yön : Sol Ve Sağ Ağırlık : 0.574 kg / 1.265 lb Not : MOTOR TAKOZU	357199381C, 357199402B 3A0199402
	<b>VW12074</b> MOTOR TAKOZU SOL VE SAĞ MOTOR TAKOZU	Yön : Sol Ve Sağ Ağırlık : 1.08 kg / 2.381 lb Not : MOTOR TAKOZU	1H0199609B, 1H0199609F 1H0199609G, 1H0199609J

\* Bu sayfada ve katalogdaki tüm araçların adları, markaları, modelleri, sembolleri, logoları, orijinal numaraları (oe) ve diğer üçüncü parti numaraları sadece referans amaçlı kullanılmaktadır.

**TOLEDO**
**I 1L**
**1993 - 1999**

Resim	Ürün Kodu ve Açıklaması	Detay	OEM
	<b>VW12092</b> MOTOR TAKOZU SAĞ MOTOR TAKOZU ARKA SAĞ	Yön : Sağ Ağırlık : 1,745 kg / 3.847 lb Not : MOTOR TAKOZU ARKA SAĞ	1H0199262B, 1H0199262G 1H0199262H
	<b>VW12095</b> MOTOR TAKOZU SOL VE SAĞ MOTOR TAKOZU	Yön : Sol Ve Sağ Ağırlık : 1,389 kg / 3.062 lb Not : MOTOR TAKOZU	191199272, 191199272A 191199273, 191199279B 191199279C, 191199279D 357199279C
	<b>VW12088</b> SÜSPANSİYON TAKOZU SOL VE SAĞ SÜSPANSİYON TAKOZU ARKA	Yön : Sol Ve Sağ Ağırlık : 0.11 kg / 0.243 lb Not : SÜSPANSİYON TAKOZU ARKA	191512131B
	<b>VW12089</b> SÜSPANSİYON TAKOZU SOL VE SAĞ SÜSPANSİYON TAKOZU	Yön : Sol Ve Sağ Ağırlık : 0.15 kg / 0.331 lb Not : SÜSPANSİYON TAKOZU	191412303A, 357412303E
	<b>VW12096</b> SÜSPANSİYON TAKOZU SOL VE SAĞ SÜSPANSİYON TAKOZU	Yön : Sol Ve Sağ Ağırlık : 0.035 kg / 0.077 lb Not : SÜSPANSİYON TAKOZU	1J0412303
	<b>VW13008</b> DİREKSİYON KÖRÜĞÜ	Ağırlık : 0.225 kg / 0.496 lb	1H0422831B
	<b>VW13010</b> DİREKSİYON KÖRÜĞÜ ÖN	Ağırlık : 0,124 kg / 0.273 lb	191422831
	<b>OP14003</b> AKS KÖRÜĞÜ +KELEPÇE+YAĞ. AKS KÖRÜĞÜ DIŞ	Ağırlık : 0.2 kg / 0.441 lb	1603180
	<b>RN14006</b> AKS KÖRÜĞÜ +KELEPÇE+YAĞ. DIŞ	Ağırlık : 0.2 kg / 0.441 lb	1603180, 1603204 16410170470106*, 16500170470106* 1H0498203, 271648 271649, 321498203A 431498203C, 443498203D
	<b>VW14013</b> AKS KÖRÜĞÜ +KELEPÇE+YAĞ. YAĞ+KELEPÇE	Ağırlık : 0.156 kg / 0.344 lb	113501149, 171407283A
	<b>VW14014</b> AKS KÖRÜĞÜ +KELEPÇE+YAĞ. YAĞ+KELEPÇE	Ağırlık : 0.28 kg / 0.617 lb	191498203C, 71498203

\* Bu sayfada ve katalogdaki tüm araçların adları, markaları, modelleri, sembolleri, logoları, orijinal numaraları (oe) ve diğer üçüncü parti numaraları sadece referans amaçlı kullanılmaktadır.

**TOLEDO**
**I 1L**
**1993 - 1999**

Resim	Ürün Kodu ve Açıklaması	Detay	OEM
	<b>VW15002</b> AMORTİSÖR KÖRÜĞÜ ARKA	Şasi (Ön / Arka) : ARKA	900064

**TOLEDO**
**II 1M2**
**1999 - 2004**

Resim	Ürün Kodu ve Açıklaması	Detay	OEM
	<b>AU1013</b> ROTİL ÖN ALT SAĞ - SOL Ø15,5 RB2535	Ağırlık : 0,555 kg / 1.224 lb Konik Ölçüsü : Ø15,5 Bağlantı Delik Çapı : Ø10,7 Aşık Diş Çapı : M12X1,5	8N0.407.365A, 8N0.407.365B 8N0.407.365C, 8N0407365A 8N0407365B, 8N0407365C
	<b>AU1014</b> ROTİL ALT SAĞ Ø15	Ağırlık : 0,35 kg / 0.772 lb Konik Ölçüsü : Ø15 Bağlantı Delik Çapı : Ø8,5 Aşık Diş Çapı : M12X1,25	1J0407366A, 1J0407366AS 1J0407366B, 1J0407366C 1J0407366D, 1J0407366H
	<b>AU1014K</b> ROTİL ÖN SAĞ Ø15 RB2530	Ağırlık : 0,5 kg / 1.102 lb Konik Ölçüsü : Ø15 Bağlantı Delik Çapı : Ø8,5 Aşık Diş Çapı : M12X1,25	1J0407366, 1J0407366A 1J0407366AS, 1J0407366B 1J0407366C, 1J0407366CS 1J0407366D*, 1J0407366D 1J0407366H, 8Z0407366A
	<b>AU1015</b> ROTİL SOL	Ağırlık : 0,35 kg / 0.772 lb Konik Ölçüsü : Ø15 Bağlantı Delik Çapı : Ø8,5 Aşık Diş Çapı : M12X1,25	1J0407365A, 1J0407365B 1J0407365C, 1J0407365D
	<b>AU1015K</b> ROTİL ÖN SOL Ø15 RB2529	Ağırlık : 0,5 kg / 1.102 lb Konik Ölçüsü : Ø15 Bağlantı Delik Çapı : Ø8,5 Aşık Diş Çapı : M12X1,25	1J0407365, 1J0407365A* 1J0407365A, 1J0407365AS 1J0407365B*, 1J0407365B 1J0407365C*, 1J0407365C 1J0407365CS, 1J0407365D*
	<b>AU2009</b> ROTBAŞI SAĞ UZUN RD0332	Ağırlık : 0,37 kg / 0.816 lb Uzunluk : 92 mm / 3.62 inch Gövde Diş Çapı : M14X1,5 Aşık Diş Çapı : M12X1,5 Aşık Konik Çapı : Ø13,3	1J0422812B, 3A0422812B 6R0423812A
	<b>AU2010</b> ROTBAŞI SOL RD0331	Ağırlık : 0,375 kg / 0.827 lb Uzunluk : 92 mm / 3.62 inch Gövde Diş Çapı : M14X1,5 Aşık Diş Çapı : M12X1,5 Aşık Konik Çapı : Ø13,2	1J0422811B, 1J0422811 3A0422811B, 6R0423811A
	<b>AU2318</b> ROTBAŞI SOL KISA RB2318	Ağırlık : 0,312 kg / 0.688 lb Uzunluk : 76 mm / 2.99 inch Gövde Diş Çapı : M14X1,5 Aşık Diş Çapı : M12X1,5 Aşık Konik Çapı : Ø13,4	1J0422811, 1J0422811A
	<b>AU2319</b> ROTBAŞI SAĞ KISA RB2319	Ağırlık : 0,315 kg / 0.694 lb Uzunluk : 76 mm / 2.99 inch Gövde Diş Çapı : M14X1,5 Aşık Diş Çapı : M12X1,5 Aşık Konik Çapı : Ø13,4	1J0422812, 1J0422812A

\* Bu sayfada ve katalogdaki tüm araçların adları, markaları, modelleri, sembolleri, logoları, orijinal numaraları (oe) ve diğer üçüncü parti numaraları sadece referans amaçlı kullanılmaktadır.



**TOLEDO****II 1M2****1999 - 2004**

Resim	Ürün Kodu ve Açıklaması	Detay	OEM
	<b>AU3001</b> ROTMİLİ SOL VE SAĞ 318 RD0908	Ağırlık : 0,622 kg / 1.371 lb Uzunluk : 318 mm / 12.52 inch Gövde Diş Çapı : M16X1,5 Aşık Diş Çapı : M14X1,5	1J0422803B, 1J0422804B 1J0422804E, 1J0422807 1J0422807B, 1J0422821B
	<b>AU3004</b> ROTMİLİ	Ağırlık : 0.35 kg / 0.772 lb Uzunluk : 320 mm / 12.60 inch	1J0422810B

**VW8001 / Süspansiyon Kit Ön**

**TOLEDO**

**II 1M2**

**1999 - 2004**



**Kit Parçaları**

Resim	Ürün Kodu / Adı	OEM	OEM	Ürün Kodu / Adı	Resim
	<b>AU2009</b> Rotbaşı Sağ Uzun Rd0332	1J0422812B, 3A0422812B 6R0423812A	1J0422811B, 1JD422811 3A0422811B, 6R0423811A	<b>AU2010</b> Rotbaşı Sol Rd0331	
	<b>AU3001</b> Rotmili Sol Ve Sağ 318 Rd0908	1J0422803B, 1J0422804B 1J0422804E, 1J0422807 1J0422807B, 1J0422821B	1J0411315E, 1J0411315G 1J0422315G	<b>VW4011</b> Z Rot Ön Sağ-sol Metal 105 Rd0916	
	<b>AU6008</b> Salıncak Ön Sağ Rb3011	1J0407151B	1J0407151A	<b>AU6009</b> Salıncak Ön Sol Rb3012	

**VW8003 / Süspansiyon Kit Ön**

**TOLEDO**

**II 1M2**









**1999 - 2004**



**Kit Parçaları**

Resim	Ürün Kodu / Adı	OEM	OEM	Ürün Kodu / Adı	Resim
	<b>AU1014</b> Rotil Alt Sağ Ø15	1J0407366A, 1J0407366AS 1J0407366B, 1J0407366C 1J0407366D, 1J0407366H	1J0407365A, 1J0407365B 1J0407365C, 1J0407365D	<b>AU1015</b> Rotil Sol	
	<b>AU11002</b> Salıncak Ve Denge Kolu Burcu Ön Sol Ve Sağ B22117	1J0407181, 1J0407181A	191407182, 357407182 357407182F	<b>AU11005</b> Salıncak Ve Denge Kolu Burcu Ön Orta Sol Ve Sağ B40115	
	<b>VW4011</b> Z Rot Ön Sağ-sol Metal 105 Rd0916	1J0411315E, 1J0411315G 1J0422315G			

**TOLEDO**
**II 1M2**
**1999 - 2004**

Resim	Ürün Kodu ve Açıklaması	Detay	OEM
	<b>AU20093001</b> ROT TAKIMI SAĞ	Ağırlık : 0,951 kg / 2.097 lb Rotbaşı : AU2009 Rotmili : AU3001	1H0422804B
	<b>AU20093004</b> ROT TAKIMI SAĞ KOMPLE	Ağırlık : 1.1 kg / 2.425 lb Rotbaşı : AU2009 Rotmili : AU3004	1J0422804B, 1J0422804C
	<b>AU20103001</b> ROT TAKIMI SOL	Ağırlık : 0,952 kg / 2.099 lb Rotbaşı : AU2010 Rotmili : AU3001	1H0422803B
	<b>AU20103004</b> ROT TAKIMI SOL KOMPLE	Ağırlık : 1.1 kg / 2.425 lb Rotbaşı : AU2010 Rotmili : AU3004	1J0422803B, 1J0422803C
	<b>AU23183004</b> ROT TAKIMI SOL RD088206	Ağırlık : 1.075 kg / 2.370 lb Rotbaşı : AU2318 Rotmili : AU3004	1J0422803B
	<b>AU23193004</b> ROT TAKIMI SAĞ RD088207	Ağırlık : 1.1 kg / 2.425 lb Rotbaşı : AU2319 Rotmili : AU3004	1J0422804B
	<b>AU4005</b> Z ROT ÖN SOL METAL RB2924	Ağırlık : 0,602 kg / 1.327 lb Malzeme Türü : Metal Uzunluk : 335 mm / 13.19 inch Aşık Diş Çapı : M12X1,5	1J0411315D, 1J0411615D
	<b>AU4006</b> Z ROT ÖN SAĞ METAL RB2923	Ağırlık : 0,282 kg / 0.622 lb Malzeme Türü : Metal Uzunluk : 335 mm / 13.19 inch Aşık Diş Çapı : M12X1,5	1J0411316D
	<b>VW4010</b> Z ROT SOL VE SAĞ PLASTİK RD0924	Ağırlık : 0,18 kg / 0.397 lb Malzeme Türü : Plastik Uzunluk : 106 mm / 4.17 inch Aşık Diş Çapı : M10X1,5	1J0411315C, 1J0411315J
	<b>VW4011</b> Z ROT ÖN SAĞ-SOL METAL 105 RD0916	Ağırlık : 0,258 kg / 0.569 lb Malzeme Türü : Metal Uzunluk : 106 mm / 4.17 inch Aşık Diş Çapı : M10X1,5	1J0411315E, 1J0411315G 1J0422315G
	<b>VW4020</b> Z ROT ÖN SAĞ-SOL PLASTİK 105,5	Ağırlık : 0,151 kg / 0.333 lb Malzeme Türü : Plastik Uzunluk : 105 mm / 4.13 inch	1J0411315B, 1J0411315H 1J0411315K

\* Bu sayfada ve katalogdaki tüm araçların adları, markaları, modelleri, sembolleri, logoları, orijinal numaraları (oe) ve diğer üçüncü parti numaraları sadece referans amaçlı kullanılmaktadır.

**TOLEDO**
**II 1M2**
**1999 - 2004**

Resim	Ürün Kodu ve Açıklaması	Detay	OEM
	<b>AU6008</b> SALINCAK ÖN SAĞ RB3011	Ağırlık : 3,495 kg / 7.705 lb Malzeme Türü : Sac Metal	1J0407151B
	<b>AU6008J</b> SALINCAK ÖN SAĞ RB3101	Ağırlık : 3,212 kg / 7.081 lb Malzeme Türü : Sac Metal	1J0407151C
	<b>AU6009</b> SALINCAK ÖN SOL RB3012	Ağırlık : 3,495 kg / 7.705 lb Malzeme Türü : Sac Metal	1J0407151A
	<b>SE9003</b> SALINCAK ALT VE ÜST SOL VE SAĞ	Ağırlık : 1,080 kg / 2.381 lb Malzeme Türü : Sac Metal	1J0505323H, 1J0505323J 1J0505323L, 1J0505323M 1J0505323N
	<b>AU11002</b> SALINCAK VE DENGE KOLU BURCU ÖN SOL VE SAĞ B22117	Şasi (Ön / Arka) : ÖN Yön : Sol Ve Sağ Ağırlık : 0,108 kg / 0.238 lb	1J0407181, 1J0407181A
	<b>AU11005</b> SALINCAK VE DENGE KOLU BURCU ÖN ORTA SOL VE SAĞ B40115	Şasi (Ön / Arka) : ÖN Yön : Orta Sol Ve Sağ Ağırlık : 0,111 kg / 0.245 lb Not : VW6014 - VW60614J	191407182, 357407182 357407182F
	<b>VW11036</b> SALINCAK VE DENGE KOLU BURCU SOL VE SAĞ	Yön : Sol Ve Sağ Ağırlık : 0.07 kg / 0.154 lb Not : BORUSU	191411315B, 4A0399413A
	<b>VW11090</b> Z-ROT BURCU ÖN	Şasi (Ön / Arka) : ÖN Ağırlık : 0,045 kg / 0.099 lb	1J0411315*, 1J0411315B* 1J0411315C*, 1J0411315E* 1J0411315G*, 1J0411315J*
	<b>VW12010</b> TORSİYON BURCU SOL VE SAĞ	Yön : Sol Ve Sağ Ağırlık : 0.31 kg / 0.683 lb	1J0500045, 1J0500045A 1J0501541B, 1J0501541C 6R0501541A, 6R0501541B
	<b>VW12066</b> TORSİYON BURCU SOL VE SAĞ	Yön : Sol Ve Sağ Ağırlık : 0.6 kg / 1.323 lb	1J0 501 541 D, 1J0501541D
	<b>VW12016</b> VİRAJ DEMİR LASTİĞİ SOL VE SAĞ RUBBER	Şasi (Ön / Arka) : ÖN Yön : Sol Ve Sağ Ağırlık : 0.03 kg / 0.066 lb Malzeme Türü : Rubber	1J0411314G, 1J0411314T 8N0411303G, 8N0411303H



\* Bu sayfada ve katalogdaki tüm araçların adları, markaları, modelleri, sembolleri, logoları, orjinal numaraları (oe) ve diğer üçüncü parti numaraları sadece referans amaçlı kullanılmaktadır.

**TOLEDO**
**II 1M2**
**1999 - 2004**

Resim	Ürün Kodu ve Açıklaması	Detay	OEM
	<b>VW12016K</b> VİRAJ DEMİR LASTİĞİ SOL VE SAĞ RUBBER	Şasi (Ön / Arka) : ÖN Yön : Sol Ve Sağ Ağırlık : 0.06 kg / 0.132 lb Malzeme Türü : Rubber Not : İKİLİ	1J0411314G, 1J0411314T 8N0411303G, 8N0411303H
	<b>VW12020</b> VİRAJ DEMİR LASTİĞİ SOL VE SAĞ RUBBER	Şasi (Ön / Arka) : ÖN Yön : Sol Ve Sağ Ağırlık : 0.07 kg / 0.154 lb Malzeme Türü : Rubber Not : VİRAJ ORTA LASTİĞİ	8D0511327C
	<b>VW12020K</b> VİRAJ DEMİR LASTİĞİ SOL VE SAĞ RUBBER	Şasi (Ön / Arka) : ÖN Yön : Sol Ve Sağ Ağırlık : 0.14 kg / 0.309 lb Malzeme Türü : Rubber	8D0511327C*
	<b>VW12064</b> VİRAJ DEMİR LASTİĞİ SOL VE SAĞ RUBBER	Şasi (Ön / Arka) : ÖN Yön : Sol Ve Sağ Ağırlık : 0,023 kg / 0.051 lb Malzeme Türü : Rubber Not : D=Ø21mm	1J0411314C, 1J0411314R
	<b>VW12064K</b> VİRAJ DEMİR LASTİĞİ SOL VE SAĞ RUBBER	Şasi (Ön / Arka) : ÖN Yön : Sol Ve Sağ Ağırlık : 0.046 kg / 0.101 lb Malzeme Türü : Rubber	1J0411314C*
	<b>VW12117</b> VİRAJ DEMİR LASTİĞİ SOL VE SAĞ RUBBER	Şasi (Ön / Arka) : ÖN Yön : Sol Ve Sağ Ağırlık : 0.08 kg / 0.176 lb Malzeme Türü : Rubber	1J0411327
	<b>VW12117K</b> VİRAJ DEMİR LASTİĞİ SOL VE SAĞ RUBBER	Şasi (Ön / Arka) : ÖN Yön : Sol Ve Sağ Ağırlık : 0.16 kg / 0.353 lb Malzeme Türü : Rubber	1J0411327
	<b>SK12002</b> AMORTİSÖR TAKOZU ARKA SOL VE SAĞ 1.2 / 1.4TSI / 1.6TDI / 1.2TDI	Şasi (Ön / Arka) : ARKA Yön : Sol Ve Sağ Ağırlık : 0,305 kg / 0.672 lb Not : 1.2 / 1.4TSI / 1.6TDI / 1.2TDI	1J0513353A, 1J0513353B 1J0513353C, 1J0513353G 6QE513353, 6R0513353 6R0513353B
	<b>VW12061</b> AMORTİSÖR TAKOZU SOL VE SAĞ AMORTİSÖR TAKOZU	Yön : Sol Ve Sağ Ağırlık : 0.27 kg / 0.595 lb Not : AMORTİSÖR TAKOZU	1H0412365A, 1J0412249 1J0412331BS, 1J0412331C
	<b>VW12061A</b> AMORTİSÖR TAKOZU SOL VE SAĞ AMORTİSOR RULMANI	Yön : Sol Ve Sağ Ağırlık : 0.08 kg / 0.176 lb Not : AMORTİSOR RULMANI	1J0412249, 1J0412249C 357412249, 357412249A 4503300051, 7201688 7201848, 95VW3K031AA
	<b>VW12061K</b> AMORTİSÖR TAKOZU SOL VE SAĞ 2 PCS	Yön : Sol Ve Sağ Ağırlık : 0.7 kg / 1.543 lb Not : 2 PCS	1H0412365A, 1J0412249 1J0412331BS, 1J0412331C





\* Bu sayfada ve katalogdaki tüm araçların adları, markaları, modelleri, sembolleri, logoları, orijinal numaraları (oe) ve diğer üçüncü parti numaraları sadece referans amaçlı kullanılmaktadır.

**TOLEDO**
**II 1M2**
**1999 - 2004**

Resim	Ürün Kodu ve Açıklaması	Detay	OEM
	<b>VW12103</b> AMORTİSÖR TAKOZU SOL VE SAĞ AMORTİSÖR ÜST TAKOZU	Yön : Sol Ve Sağ Ağırlık : 0.23 kg / 0.507 lb Not : AMORTİSÖR ÜST TAKOZU	1J0412331B, 1J0412331C
	<b>VW12070</b> MOTOR TAKOZU SOL VE SAĞ MOTOR TAKOZU	Yön : Sol Ve Sağ Ağırlık : 1.64 kg / 3.616 lb Not : MOTOR TAKOZU	1J0199555AH
	<b>VW12075</b> MOTOR TAKOZU SOL VE SAĞ MOTOR TAKOZU	Yön : Sol Ve Sağ Ağırlık : 2.2 kg / 4.850 lb Not : MOTOR TAKOZU	1J0199262BF
	<b>VW12081</b> MOTOR TAKOZU SOL VE SAĞ MOTOR TAKOZU	Yön : Sol Ve Sağ Ağırlık : 2.04 kg / 4.497 lb Not : MOTOR TAKOZU	1J0199262BK
	<b>VW12084</b> MOTOR TAKOZU SOL VE SAĞ MOTOR TAKOZU	Yön : Sol Ve Sağ Ağırlık : 2.034 kg / 4.484 lb Not : MOTOR TAKOZU	1J0199262BE
	<b>VW12100</b> MOTOR TAKOZU SOL VE SAĞ MOTOR TAKOZU ARKA	Yön : Sol Ve Sağ Ağırlık : 1.12 kg / 2.469 lb Not : MOTOR TAKOZU ARKA	1J0199851AA, 1J0199851AK 1J0199851M, 1J0199851N
	<b>VW12102</b> MOTOR TAKOZU SOL VE SAĞ MOTOR TAKOZU	Yön : Sol Ve Sağ Ağırlık : 1.64 kg / 3.616 lb Not : MOTOR TAKOZU	1J0199555AJ, 1J0199555AM 1J0199555AQ, 1J0199555BH
	<b>VW12096</b> SÜSPANSİYON TAKOZU SOL VE SAĞ SÜSPANSİYON TAKOZU	Yön : Sol Ve Sağ Ağırlık : 0.035 kg / 0.077 lb Not : SÜSPANSİYON TAKOZU	1J0412303
	<b>VW13002</b> RIW DİREKSİYON KÖRÜĞÜ	Ağırlık : 0.1 kg / 0.220 lb	1J0422831, 1J0422831B 8N0422831
	<b>VW13002K</b> DİREKSİYON KÖRÜĞÜ SOL VE SAĞ 2 PİECES	Ağırlık : 0.2 kg / 0.441 lb	1J0422831, 1J0422831B 8N0422831
	<b>VW13006</b> DİREKSİYON KÖRÜĞÜ	Ağırlık : 0.145 kg / 0.320 lb	1K0423831A, 5C0423831

\* Bu sayfada ve katalogdaki tüm araçların adları, markaları, modelleri, sembolleri, logoları, orjinal numaraları (oe) ve diğer üçüncü parti numaraları sadece referans amaçlı kullanılmaktadır.

**TOLEDO**
**II 1M2**
**1999 - 2004**

Resim	Ürün Kodu ve Açıklaması	Detay	OEM
	<b>VW13006K</b> DİREKSİYON KÖRÜĞÜ SOL VE SAĞ 2 PİECES	Ağırlık : 0.29 kg / 0.639 lb	1K0423831A, 5C0423831
	<b>F114014</b> AKS KÖRÜĞÜ +KELEPÇE+YAĞ. DIŞ	Ağırlık : 0.211 kg / 0.465 lb	46307841
	<b>VW14003</b> AKS KÖRÜĞÜ +KELEPÇE+YAĞ. DIŞ	Ağırlık : 0.25 kg / 0.551 lb	1K0 498 203, 1K0498203
	<b>VW15002</b> AMORTİSÖR KÖRÜĞÜ ARKA	Şasi (Ön / Arka) : ARKA	900064

**TOLEDO**
**III 5P2**
**2004 - 2009**

Resim	Ürün Kodu ve Açıklaması	Detay	OEM
	<b>VW1014</b> ROTİL ÖN ALT SAĞ Ø15,6 RB2536	Ağırlık : 0,565 kg / 1.246 lb Konik Ölçüsü : Ø15,6 Bağlantı Delik Çapı : Ø10,5 Aşık Diş Çapı : M12X1,5	1K0407366B, 1K0407366C 1K0407366E, 5Q0407366A
	<b>VW1015</b> ROTİL ÖN ALT SOL Ø15,6 RB2537	Ağırlık : 0,565 kg / 1.246 lb Konik Ölçüsü : Ø15,6 Bağlantı Delik Çapı : Ø10,5 Aşık Diş Çapı : M12X1,5	1K0407365B, 1K0407365C 1K0407365E, 5Q0407365A
	<b>VW2008</b> ROTBAŞI ÖN SAĞ RD0342	Ağırlık : 0,412 kg / 0.908 lb Uzunluk : 95 mm / 3.74 inch Gövde Diş Çapı : M16X1,5 Aşık Diş Çapı : M12X1,5 Aşık Konik Çapı : Ø12,7	1K0423812A, 1K0423812C 1K0423812E, 1K0423812G 1K0423812J, 1K0423812K 1KD423812A
	<b>VW2009</b> ROTBAŞI ÖN SOL RD0343	Ağırlık : 0,412 kg / 0.908 lb Uzunluk : 95 mm / 3.74 inch Gövde Diş Çapı : M16X1,5 Aşık Diş Çapı : M12X1,5 Aşık Konik Çapı : Ø13,5	1K0423811A, 1K0423811C 1K0423811E, 1K0423811G 1K0423811J, 1K0423811K 1KD423811A
	<b>VW3009</b> ROTMİLİ SAĞ-SOL 310 RB2838	Ağırlık : 0,665 kg / 1.466 lb Uzunluk : 311 mm / 12.24 inch Gövde Diş Çapı : M16X1,5 Aşık Diş Çapı : M16X1,5	1K0423810A
	<b>VW20083009</b> ROT TAKIMI ÖN AKS SAĞ RB288137	Ağırlık : 1,078 kg / 2.377 lb Rotbaşı : VW2008 Rotmili : VW3009	

\* Bu sayfada ve katalogdaki tüm araçların adları, markaları, modelleri, sembolleri, logoları, orjinal numaraları (oe) ve diğer üçüncü parti numaraları sadece referans amaçlı kullanılmaktadır.



**TOLEDO**
**III 5P2**
**2004 - 2009**

Resim	Ürün Kodu ve Açıklaması	Detay	OEM
	<b>VW20093009</b> ROT TAKIMI ÖN SOL RB288138	Ağırlık : 1,077 kg / 2.374 lb Rotbaşı : VW2009 Rotmili : VW3009	
	<b>SK4005</b> Z ROT ÖM SAĞ-SOL L=335MM	Ağırlık : 0,322 kg / 0.710 lb Malzeme Türü : Metal Uzunluk : 335 mm / 13.19 inch Aşık Diş Çapı : M12X1,5	5Q0411315B
	<b>VW4014</b> Z ROT ÖN SAĞ-SOL METAL 335 RB2935	Ağırlık : 0,46 kg / 1.014 lb Malzeme Türü : Metal Uzunluk : 335 mm / 13.19 inch Aşık Diş Çapı : M12X1,5	1K0411315B, 1K0411315D 1K0411315J, 1K0411315K 1K0411315R, 5Q0411315A 5Q0411315B
	<b>VW4015</b> Z ROT SOL VE SAĞ METAL RB2937	Ağırlık : 0,373 kg / 0.822 lb Malzeme Türü : Metal Uzunluk : 95,5 mm / 3.76 inch Aşık Diş Çapı : M10X1,5	1K0505465C, 1K0505465D 1K0505465H, 1K0505465J 1K0505465K
	<b>VW4015K</b> Z ROT SOL VE SAĞ METAL	Ağırlık : 0,373 kg / 0.822 lb Malzeme Türü : Metal Uzunluk : 95,5 mm / 3.76 inch Aşık Diş Çapı : M10X1,5	1K0505465C, 1K0505465D 1K0505465H, 1K0505465J 1K0505465K
	<b>SE9001</b> SALINCAK ALT SAĞ RA5150	Ağırlık : 1 kg / 2.205 lb Malzeme Türü : Sac Metal	1K0501530C
	<b>SE9002</b> SALINCAK ALT SOL RA5151	Ağırlık : 1 kg / 2.205 lb Malzeme Türü : Sac Metal	1K0501529F
	<b>SK9001</b> SALINCAK ARKA ALT	Ağırlık : 0,701 kg / 1.545 lb Malzeme Türü : Sac Metal	1K0501529J
	<b>VW6016</b> SALINCAK ÖN SAĞ RD10227	Ağırlık : 4,543 kg / 10.016 lb Malzeme Türü : Sac Metal	1K0407152P, 1K0407152Q* 1K0407152Q
	<b>VW6016J</b> SALINCAK ÖN ALT SAĞ S737	Ağırlık : 4,015 kg / 8.852 lb Malzeme Türü : Sac Metal	1K0407151P, 1K0407151Q 1K0407152P, 1K0407152Q
	<b>VW6017</b> SALINCAK ÖN SOL RD10226	Ağırlık : 4,543 kg / 10.016 lb Malzeme Türü : Sac Metal	1K0407151M*, 1K0407151P 1K0407151Q*, 1K0407151Q

\* Bu sayfada ve katalogdaki tüm araçların adları, markaları, modelleri, sembolleri, logoları, orjinal numaraları (oe) ve diğer üçüncü parti numaraları sadece referans amaçlı kullanılmaktadır.

**TOLEDO**
**III 5P2**
**2004 - 2009**

Resim	Ürün Kodu ve Açıklaması	Detay	OEM
	<b>VW6017J</b> SALINCAK ÖN ALT SOL S738	Ağırlık : 4,015 kg / 8.852 lb Malzeme Türü : Sac Metal	1K0407151P, 1K0407151Q 1K0407152P, 1K0407152Q
	<b>VW6018</b> SALINCAK ÖN SAĞ RB30219	Ağırlık : 4,85 kg / 10.692 lb Malzeme Türü : Döküm Çelik	1K0407152AC*, 1K0407152M* 1K0407152P, 1K0407152Q 1K0407152R*
	<b>VW6018J</b> SALINCAK ÖN SAĞ RB30211	Ağırlık : 4,232 kg / 9.330 lb Malzeme Türü : Döküm Çelik	1K0407152AC, 1K0407152M 1K0407152R
	<b>VW6019</b> SALINCAK ÖN SOL RB30218	Ağırlık : 4,85 kg / 10.692 lb Malzeme Türü : Döküm Çelik	1K0407151AC*, 1K0407151AC 1K0407151M*, 1K0407151M 1K0407151R*, 1K0407151R
	<b>VW6019J</b> SALINCAK ÖN SOL RB30212	Ağırlık : 4,232 kg / 9.330 lb Malzeme Türü : Döküm Çelik	1K0407151AC, 1K0407151M 1K0407151R
	<b>VW9001</b> SALINCAK ARKA	Ağırlık : 2,55 kg / 5.622 lb Malzeme Türü : Sac Metal	1K0505311AA, 1K0505311ABÂ 1K0505311H, 1K0505311S 1K0505311T
	<b>SK11009</b> SALINCAK VE DENGELİ KOLU BURCU ARKA SOL VE SAĞ	Şasi (Ön / Arka) : ARKA Yön : Sol Ve Sağ Ağırlık : 0,176 kg / 0.388 lb	1K0501529J*
	<b>SK11010</b> SALINCAK VE DENGELİ KOLU BURCU ARKA SOL VE SAĞ	Şasi (Ön / Arka) : ARKA Yön : Sol Ve Sağ Ağırlık : 0,196 kg / 0.432 lb Not : BÜYÜK	1K0501529J*
	<b>VW11037</b> SALINCAK VE DENGELİ KOLU BURCU SOL VE SAĞ	Yön : Sol Ve Sağ Ağırlık : 0.11 kg / 0.243 lb	1K0505279A
	<b>VW11042</b> SALINCAK VE DENGELİ KOLU BURCU ORTA SOL VE SAĞ	Yön : Orta Sol Ve Sağ Ağırlık : 0,182 kg / 0.401 lb	1K0407182, 5Q0407182
	<b>VW11043</b> SALINCAK VE DENGELİ KOLU BURCU SAĞ B22141	Yön : Sağ Diğer Taraf : VW11044 Ağırlık : 0,659 kg / 1.453 lb	1K0199232G, 1K0199232H 1K0199232J

\* Bu sayfada ve katalogdaki tüm araçların adları, markaları, modelleri, sembolleri, logoları, orijinal numaraları (oe) ve diğer üçüncü parti numaraları sadece referans amaçlı kullanılmaktadır.

**TOLEDO**
**III 5P2**
**2004 - 2009**

Resim	Ürün Kodu ve Açıklaması	Detay	OEM
	<b>VW11043B</b> SALINCAK VE DENGELER KOLU BURCU SAĞ	Yön : Sağ Diğer Taraf : VW11044B Ağırlık : 0,659 kg / 1.453 lb Not : İÇ BURÇSUZ	1K0199232G, 1K0199232H 1K0199232J
	<b>VW11044</b> SALINCAK VE DENGELER KOLU BURCU SOL B22142	Yön : Sol Diğer Taraf : VW11043 Ağırlık : 0,678 kg / 1.495 lb	1K0199231G, 1K0199231H 1K0199231J
	<b>VW11044B</b> SALINCAK VE DENGELER KOLU BURCU SOL	Yön : Sol Diğer Taraf : VW11043B Ağırlık : 0,678 kg / 1.495 lb Not : İÇ BURÇSUZ	1K0199231G, 1K0199231H 1K0199231J
	<b>VW11047</b> SALINCAK VE DENGELER KOLU BURCU İÇ SOL VE SAĞ B37117	Yön : İÇ Sol Ve Sağ Ağırlık : 0,121 kg / 0.267 lb	1K0199231J, 1K0199231J-P 1K0407183E
	<b>VW11051</b> SALINCAK VE DENGELER KOLU BURCU SOL VE SAĞ	Yön : Sol Ve Sağ Ağırlık : 0.121 kg / 0.267 lb	6Q0407183, 6Q0407183A
	<b>VW11055</b> SALINCAK VE DENGELER KOLU BURCU İÇ SOL VE SAĞ	Yön : İÇ Sol Ve Sağ Ağırlık : 0.121 kg / 0.267 lb	1K0407183E, 8J0407183
	<b>VW11056</b> SALINCAK VE DENGELER KOLU BURCU ARKA SOL VE SAĞ	Şasi (Ön / Arka) : ARKA Yön : Sol Ve Sağ Ağırlık : 0.13 kg / 0.287 lb	1K0505203A, 1K0505323D 1K0505323G, 1K0505323H 1K0505323N, 5Q0505323C
	<b>VW11180</b> Z-ROT BURCU ARKA	Şasi (Ön / Arka) : ARKA Ağırlık : 0.069 kg / 0.152 lb Uzunluk : VW4015 mm / 0.00 inch Aşık Dış Çapı : VW4015K	1K0505465C*, 1K0505465D* 1K0505465H*, 1K0505465J* 1K0505465K*
	<b>VW12159</b> TAŞIYICI DESTEK BURÇLARI ARKA SOL VE SAĞ	Şasi (Ön / Arka) : ARKA Yön : Sol Ve Sağ Ağırlık : 0,130 kg / 0.287 lb	1K0505553, 1K0505553A
	<b>SK12003</b> VİRAJ DEMİR LASTİĞİ SOL VE SAĞ RUBBER	Şasi (Ön / Arka) : ÖN Yön : Sol Ve Sağ Ağırlık : 0,075 kg / 0.165 lb Malzeme Türü : Rubber	1K0411303, 1K0411303AL* 1K0411303BK, 1K0411314 3C0411303AA*, 3C0411303T*
	<b>SK12003K</b> VİRAJ DEMİR LASTİĞİ SOL VE SAĞ RUBBER	Şasi (Ön / Arka) : ÖN Yön : Sol Ve Sağ Ağırlık : 0,150 kg / 0.331 lb Malzeme Türü : Rubber	1K0411303, 1K0411303AL* 1K0411303BK, 1K0411314 3C0411303AA*, 3C0411303T*

\* Bu sayfada ve katalogdaki tüm araçların adları, markaları, modelleri, sembolleri, logoları, orijinal numaraları (oe) ve diğer üçüncü parti numaraları sadece referans amaçlı kullanılmaktadır.

**TOLEDO**
**III 5P2**
**2004 - 2009**

Resim	Ürün Kodu ve Açıklaması	Detay	OEM
	<b>VW12017</b> AMORTİSÖR TAKOZU SOL VE SAĞ AMORTİSÖR TAKOZU	Yön : Sol Ve Sağ Ağırlık : 0.847 kg / 1.867 lb Not : AMORTİSÖR TAKOZU	1K0412331B, 1K0412331C
	<b>VW12109</b> AMORTİSÖR TAKOZU SOL VE SAĞ AMORTİSÖR RULMANI	Yön : Sol Ve Sağ Ağırlık : 0.26 kg / 0.573 lb Not : AMORTİSÖR RULMANI	6N0412249C, 6N0412249E
	<b>VW12109K</b> AMORTİSÖR TAKOZU SOL VE SAĞ 2 PCS	Yön : Sol Ve Sağ Ağırlık : 0.52 kg / 1.146 lb Not : 2 PCS	6N0412249C, 6N0412249E
	<b>VW12032</b> MOTOR TAKOZU SOL VE SAĞ MOTOR TAKOZU	Yön : Sol Ve Sağ Ağırlık : 0.64 kg / 1.411 lb Not : Motor takozu	1K0199855BB, 1K0199855L
	<b>VW12033</b> MOTOR TAKOZU SOL VE SAĞ MOTOR TAKOZU	Yön : Sol Ve Sağ Ağırlık : 1.84 kg / 4.057 lb Not : Motor takozu	1K0199555AQ, 1K0199555AR 1K0199555Q, 1K0199555R 3C0199555AA, 3C0199555R
	<b>VW12034</b> MOTOR TAKOZU SOL VE SAĞ MOTOR TAKOZU	Yön : Sol Ve Sağ Ağırlık : 1.9 kg / 4.189 lb Not : Motor takozu	1K0199555BA, 1K0199555BB 1K0199555L, 1K0199555M 1L0199555L
	<b>VW12073</b> MOTOR TAKOZU SOL VE SAĞ MOTOR TAKOZU	Yön : Sol Ve Sağ Ağırlık : 1.643 kg / 3.622 lb Not : MOTOR TAKOZU	1K0199262AC, 1K0199262AL 1K0199262L
	<b>VW12076</b> MOTOR TAKOZU SOL VE SAĞ MOTOR TAKOZU	Yön : Sol Ve Sağ Ağırlık : 1.97 kg / 4.343 lb Not : MOTOR TAKOZU	1K0199262AF, 1K0199262AT 1K0199262BB
	<b>VW12094</b> MOTOR TAKOZU SOL VE SAĞ MOTOR TAKOZU	Yön : Sol Ve Sağ Ağırlık : 1.872 kg / 4.127 lb Not : MOTOR TAKOZU	1K0199555N
	<b>VW12097</b> MOTOR TAKOZU SOL VE SAĞ MOTOR TAKOZU	Yön : Sol Ve Sağ Ağırlık : 0.251 kg / 0.553 lb Not : MOTOR TAKOZU	1K0199868, 1K0199868A 1K0199868C, 1K0199868P 1K0199868Q
	<b>VW12110</b> MOTOR TAKOZU SOL VE SAĞ MOTOR TAKOZU	Yön : Sol Ve Sağ Ağırlık : 1.918 kg / 4.228 lb Not : MOTOR TAKOZU	1K0199262AB, 1K0199262AM 1K0199262M

\* Bu sayfada ve katalogdaki tüm araçların adları, markaları, modelleri, sembolleri, logoları, orjinal numaraları (oe) ve diğer üçüncü parti numaraları sadece referans amaçlı kullanılmaktadır.

**TOLEDO**
**III 5P2**
**2004 - 2009**

Resim	Ürün Kodu ve Açıklaması	Detay	OEM
	<b>VW12124</b> MOTOR TAKOZU SOL VE SAĞ	Yön : Sol Ve Sağ Ağırlık : 1.927 kg / 4.248 lb	1K0199262A, 1K0199262AA 1K0199262AS
	<b>VW12106</b> ŞANZIMAN TAKOZU SOL ŞANZUMAN TAKOZU SOL	Yön : Sol Ağırlık : 1.95 kg / 4.299 lb Not : ŞANZUMAN TAKOZU SOL	1K0199555AT, 1K0199555T
	<b>VW12051</b> SÜSPANSİYON TAKOZU SOL VE SAĞ LASTİK DAYANAK SÜSPANSİYON	Yön : Sol Ve Sağ Ağırlık : 0.045 kg / 0.099 lb Not : LASTİK DAYANAK SÜSPANSİYON	1K0412303B
	<b>VW12086</b> RADYATÖR TAKOZU SOL VE SAĞ RADYATÖR ÜST LASTİĞİ	Yön : Sol Ve Sağ Ağırlık : 0.024 kg / 0.053 lb Not : RADYATÖR ÜST LASTİĞİ	1K0121367F
	<b>VW13006</b> DİREKSİYON KÖRÜĞÜ	Ağırlık : 0.145 kg / 0.320 lb	1K0423831A, 5C0423831
	<b>VW13006K</b> DİREKSİYON KÖRÜĞÜ SOL VE SAĞ 2 PİECES	Ağırlık : 0.29 kg / 0.639 lb	1K0423831A, 5C0423831
	<b>VW14003</b> AKS KÖRÜĞÜ +KELEPÇE+YAĞ. DIŞ	Ağırlık : 0.25 kg / 0.551 lb	1K0 498 203, 1K0498203
	<b>VW14011</b> AKS KÖRÜĞÜ +KELEPÇE+YAĞ. İÇ	Ağırlık : 0.236 kg / 0.520 lb	1K0498201D
	<b>AU15001</b> AMORTİSÖR KÖRÜĞÜ ÖN	Şasi (Ön / Arka) : ÖN Ağırlık : 0,110 kg / 0.243 lb	6N0413175A

**TOLEDO**
**IV NH**
**2013 - 2019**

Resim	Ürün Kodu ve Açıklaması	Detay	OEM
	<b>SK1025</b> ROTİL SAĞ	Ağırlık : 0,59 kg / 1.301 lb Konik Ölçüsü : Ø15 Bağlantı Delik Çapı : Ø10,5 Aşık Dış Çapı : M12X1,5	5U0407366A, 6R0407366 6R0407366A, 6R0407366B







\* Bu sayfada ve katalogdaki tüm araçların adları, markaları, modelleri, sembolleri, logoları, orjinal numaraları (oe) ve diğer üçüncü parti numaraları sadece referans amaçlı kullanılmaktadır.

**TOLEDO**
**IV NH**
**2013 - 2019**

Resim	Ürün Kodu ve Açıklaması	Detay	OEM
	<b>SK1026</b> ROTİL ÖN ALT SOL Ø15	Ağırlık : 0,59 kg / 1.301 lb Konik Ölçüsü : Ø15 Bağlantı Delik Çapı : Ø10,5 Aşık Diş Çapı : M12X1,5	5U0407365A, 6R0407365 6R0407365A, 6R0407365B
	<b>SK2006</b> ROTBAŞI SAĞ	Ağırlık : 0,420 kg / 0.926 lb Uzunluk : 94 mm / 3.70 inch Gövde Diş Çapı : M14X1,5 Aşık Diş Çapı : M12X1,5 Aşık Konik Çapı : Ø13,3	6C0423812A
	<b>SK2007</b> ROTBAŞI SOL	Ağırlık : 0,420 kg / 0.926 lb Uzunluk : 94 mm / 3.70 inch Gövde Diş Çapı : M14X1,5 Aşık Diş Çapı : M12X1,5 Aşık Konik Çapı : Ø13,3	6C0423811A
	<b>AU3012</b> ROTMİLİ SAĞ-SOL M14X1,5 L=312MM	Ağırlık : 0,6 kg / 1.323 lb Uzunluk : 312 mm / 12.28 inch Gövde Diş Çapı : M14X1,5 Aşık Diş Çapı : M14X1,5	6C0423810A, 6C0423810B 6C0423810C
	<b>AU4028</b> Z ROT ÖN	Ağırlık : 0,368 kg / 0.811 lb Malzeme Türü : Metal Uzunluk : 270 mm / 10.63 inch Aşık Diş Çapı : M10X1,5	6Q0411315L, 6Q0411315N 8Z0411315D
	<b>VW12010</b> TORSİYON BURCU SOL VE SAĞ	Yön : Sol Ve Sağ Ağırlık : 0.31 kg / 0.683 lb	1J0500045, 1J0500045A 1J0501541B, 1J0501541C 6R0501541A, 6R0501541B
	<b>VW12024</b> VİRAJ DEMİR LASTİĞİ SOL VE SAĞ RUBBER	Şasi (Ön / Arka) : ÖN Yön : Sol Ve Sağ Ağırlık : 0.03 kg / 0.066 lb Malzeme Türü : Rubber Not : VİRAJ LASTİĞİ	6Q0411303AA, 6Q0411303AD 6Q0411305H, 6Q0411314M 6Q0411314Q
	<b>VW12024K</b> VİRAJ DEMİR LASTİĞİ SOL VE SAĞ RUBBER	Şasi (Ön / Arka) : ÖN Yön : Sol Ve Sağ Ağırlık : 0.06 kg / 0.132 lb Malzeme Türü : Rubber Not : VİRAJ LASTİĞİ (İKİLİ)	6Q0411303AA*, 6Q0411303AA 6Q0411303AD*, 6Q0411303AD 6Q0411305H*, 6Q0411305H 6Q0411314M*, 6Q0411314M 6Q0411314Q*, 6Q0411314Q
	<b>SK12002</b> AMORTİSÖR TAKOZU ARKA SOL VE SAĞ 1.2 / 1.4TSI / 1.6TDI / 1.2TDI	Şasi (Ön / Arka) : ARKA Yön : Sol Ve Sağ Ağırlık : 0.305 kg / 0.672 lb Not : 1.2 / 1.4TSI / 1.6TDI / 1.2TDI	1J0513353A, 1J0513353B 1J0513353C, 1J0513353G 6QE513353, 6R0513353 6R0513353B
	<b>VW12103</b> AMORTİSÖR TAKOZU SOL VE SAĞ AMORTİSÖR ÜST TAKOZU	Yön : Sol Ve Sağ Ağırlık : 0.23 kg / 0.507 lb Not : AMORTİSÖR ÜST TAKOZU	1J0412331B, 1J0412331C
	<b>SE12001</b> MOTOR TAKOZU ÖN SOL VE SAĞ	Şasi (Ön / Arka) : ÖN Yön : Sol Ve Sağ Ağırlık : 1,360 kg / 2.998 lb	6C0199851J

\* Bu sayfada ve katalogdaki tüm araçların adları, markaları, modelleri, sembolleri, logoları, orijinal numaraları (oe) ve diğer üçüncü parti numaraları sadece referans amaçlı kullanılmaktadır.

**TOLEDO**
**IV NH**
**2013 - 2019**

Resim	Ürün Kodu ve Açıklaması	Detay	OEM
	<b>SE12003</b> MOTOR TAKOZU ÖN SOL VE SAĞ	Şasi (Ön / Arka) : ÖN Yön : Sol Ve Sağ Ağırlık : 1,900 kg / 4.189 lb	6C0199167B
	<b>SE12004</b> MOTOR TAKOZU ÖN SOL VE SAĞ	Şasi (Ön / Arka) : ÖN Yön : Sol Ve Sağ Ağırlık : 1,300 kg / 2.866 lb	6C0199262A
	<b>VW12086</b> RADYATÖR TAKOZU SOL VE SAĞ RADYATÖR ÜST LASTİĞİ	Yön : Sol Ve Sağ Ağırlık : 0.024 kg / 0.053 lb Not : RADYATÖR ÜST LASTİĞİ	1K0121367F
	<b>AU14001</b> AKS KÖRÜĞÜ +KELEPÇE+YAĞ.	Ağırlık : 0.233 kg / 0.514 lb	6Q0498203A
	<b>VW14003</b> AKS KÖRÜĞÜ +KELEPÇE+YAĞ. DIŞ	Ağırlık : 0.25 kg / 0.551 lb	1K0 498 203, 1K0498203
	<b>VW15002</b> AMORTİSÖR KÖRÜĞÜ ARKA	Şasi (Ön / Arka) : ARKA	900064

**RIW<sup>®</sup>**

**NOTLAR**



Ürün Kodu	Bilgi Notu
<b>AU1013</b> ROTİL ÖN ALT SAĞ - SOL Ø15,5 RB2535	FOR QUATTRO A3-S3 ONLY: 2001 -
<b>AU1014K</b> ROTİL ÖN SAĞ Ø15 RB2530	WITH CONNECTING METAL
<b>AU1015K</b> ROTİL ÖN SOL Ø15 RB2529	WITH CONNECTING METAL
<b>AU12004</b> VİRAJ DEMİR LASTİĞİ SOL VE SAĞ RUBBER	INTERNAL DIAMETER=Ø29mm
<b>AU12019K</b> MOTOR TAKOZU SOL VE SAĞ MOTOR TAKOZU TAKIM	KIT = AU12019 and AU12020
<b>AU12026</b> MOTOR TAKOZU ÖN SOL VE SAĞ	AUDI A3 : 1.6 TDI - 2,0 TDI / AUDI TT : 1.8 TFSI - 2,0 TFSI / SEAT LEON: PDT - PFL - PFN / VW GOLF VII AND TOURAN : 1,4 TSI - 1.6 TDI - 2.0 TSI - 2.0 TDI / VW TOURAN : 1.6 TDI - 2.0 TDI / SEAT ATECA : 1,0 TSI - 1,6 TDI - 2,0 TDI /
<b>AU14001</b> AKS KÖRÜĞÜ +KELEPÇE+YAĞ.	SET = BELOW, CLAMPING CLIP and MOLYBDENUM GREASE
<b>AU20093001</b> ROT TAKIMI SAĞ	CH. NO: 8L.W-050-423 -->
<b>AU20103001</b> ROT TAKIMI SOL	CH. NO: 8L.W-050-423 -->
<b>AU2318</b> ROTBAŞI SOL KISA RB2318	CH. NO:-->8L-W-050-422
<b>AU2319</b> ROTBAŞI SAĞ KISA RB2319	CH. NO:--> 8L-W-050-422
<b>AU3001</b> ROTMİLİ SOL VE SAĞ 318 RD0908	CH. NO: 8L-W-050-423 ->
<b>AU4014</b> Z ROT ÖN SAĞ ALİMİNYUM 90 RB2926	YEAR: 2000--->
<b>AU4015</b> Z ROT ÖN SOL ALİMİNYUM 90 RB2927	YEAR: 2000--->
<b>AU5085</b> SALINCAK ÖN ÜST ÖNDEN SAĞ	ONLY FOR SPORT SUSPENSION
<b>AU5086</b> SALINCAK ÖN ÜST ÖNDEN SOL	ONLY FOR SPORT SUSPENSION
<b>AU5087</b> SALINCAK ÖN ÜST ARKADAN SAĞ	ONLY FOR SPORT SUSPENSION

Ürün Kodu	Bilgi Notu
<b>AU5088</b> SALINCAK ÖN ÜST ARKADAN SOL	ONLY FOR SPORT SUSPENSION
<b>AU9010</b> SALINCAK ARKA ÜST SAĞ	REARWARD
<b>AU9011</b> SALINCAK ARKA ÜST SOL	REARWARD
<b>F112006</b> ŞAFT TAKOZU SOL VE SAĞ ŞART ARA YATAK RULMANSIZ (KF1005)	WITHOUT BEARING
<b>F112006K</b> ŞAFT TAKOZU SOL VE SAĞ ŞAFT ARA YATAK RULMANLI	WITH BEARING
<b>F112067</b> AMORTİSÖR TAKOZU SOL VE SAĞ AMORTİSÖR TAKOZU ÖN	1974-2001
<b>F112069</b> AMORTİSÖR TAKOZU SOL VE SAĞ AMORTİSÖR TAKOZU ÖN	1974 - 2001
<b>F112073</b> ŞANZIMAN TAKOZU SOL VE SAĞ ŞANZIMAN TAKOZU	1974 - 2001 / 1300
<b>F112074</b> ŞANZIMAN TAKOZU SOL VE SAĞ ŞANZIMAN TAKOZU	1974 - 2001 / 1600
<b>F112075</b> ŞANZIMAN TAKOZU SOL VE SAĞ ŞANZIMAN TAKOZU	1974 - 2001
<b>F112171</b> RADYATÖR TAKOZU SOL VE SAĞ RADYATÖR ALT LASTİĞİ	FOR RADIATOR
<b>F112206K</b> DİREKSİYON TAKOZU ÖN SAĞ KİT	2 PIECES IN 1 BOX
<b>F112207K</b> DİREKSİYON TAKOZU ÖN SOL KİT	2 PIECES IN 1 BOX
<b>F113004</b> RIW DİREKSİYON KÖRÜĞÜ ( K21054 ) SAĞ	1977-
<b>F113005</b> RIW DİREKSİYON KÖRÜĞÜ ( K21057 ) SOL	1977-
<b>F113006</b> DİREKSİYON KÖRÜĞÜ SAĞ	1977-
<b>F113007</b> DİREKSİYON KÖRÜĞÜ SOL	1977-

Ürün Kodu	Bilgi Notu
<b>FI14001</b> AKS KÖRÜĞÜ +KELEPÇE+YAĞ. İÇ SEGMANLI	SET = BELOW, CLAMPING CLIP and MOLYBDENUM GREASE / 1988 - 1997
<b>FI14003</b> AKS KÖRÜĞÜ +KELEPÇE+YAĞ. İÇ BİLYALI Ø23	SET = BELOW, CLAMPING CLIP, MOLYBDENUM GREASE / WITH BEARING / D=Ø23
<b>FI14007</b> AKS KÖRÜĞÜ +KELEPÇE+YAĞ. DIŞ	SET = BELOW, CLAMPING CLIP and MOLYBDENUM GREASE / OUTER
<b>FI14014</b> AKS KÖRÜĞÜ +KELEPÇE+YAĞ. DIŞ	SET = BELOW, CLAMPING CLIP, MOLYBDENUM GREASE / 1.3
<b>FI2006</b> ROTBAŞI SOL VE SAĞ RB5321	MANUAL STEERING
<b>FI2007</b> ROTBAŞI SAĞ-SOL RB5322	POWER STEERING
<b>FI3001</b> ROTMİLİ MANUEL STR 284 MM 275 RB5814	MANUAL STEERING
<b>FI3001A</b> ROTMİLİ SAĞ-SOL 270	MANUAL STEERING
<b>FI3002</b> ROTMİLİ M12X1,5 L=285	POWER STEERING
<b>FI3003</b> ROTMİLİ SLX SAĞ--SOL HİDROLİK 275 RB5822	ONLY : SLX / POWER STERING
<b>FI3008</b> ROTMİLİ SAĞ-SOL MANUEL 275 RB5819	MANUAL STEERING
<b>FI5611</b> SALINCAK ÖN ALT SOL VE SAĞ DÖKÜM RB5611	CHANGEABLE BALL JOINT
<b>FI5614</b> SALINCAK ÖN RB5614	YEAR: 1978-->
<b>FI8001</b> SÜSPANSİYON KİT ÖN	MANUAL STEERING
<b>FI8011</b> SÜSPANSİYON KİT ÖN	For SLX
<b>OP14003</b> AKS KÖRÜĞÜ +KELEPÇE+YAĞ. AKS KÖRÜĞÜ DIŞ	SET = BELOW, CLAMPING CLIP and MOLYBDENUM GREASE / OUTER
<b>RN14006</b> AKS KÖRÜĞÜ +KELEPÇE+YAĞ. DIŞ	SET = BELOW, CLAMPING CLIP and MOLYBDENUM GREASE / OUTER

Ürün Kodu	Bilgi Notu
<b>RN14017</b> AKS KÖRÜĞÜ +KELEPÇE+YAĞ. DIŞ	SET = BELOW, CLAMPING CLIP and MOLYBDENUM GREASE / OUTER
<b>SE12001</b> MOTOR TAKOZU ÖN SOL VE SAĞ	AUDI A1 YEARS ONLY: 2014-2018 / SEAT IBIZA ONLY: IV 2015-2017 / 1,4 TDI / VOLKSWAGEN POLO YEARS ONLY: 2014 -
<b>SE12002</b> MOTOR TAKOZU ÖN SOL VE SAĞ	SEAT IBIZA ONLY: IV 2015 -2017 / VOLKSWAGEN POLO YEARS ONLY: 2014 -
<b>SE12003</b> MOTOR TAKOZU ÖN SOL VE SAĞ	1,0 - 1,2 TSI / SEAT IBIZA ONLY: IV 2015 - / VOLKSWAGEN POLO YEARS ONLY: 2014 -
<b>SE12004</b> MOTOR TAKOZU ÖN SOL VE SAĞ	AUDI A1 YEARS ONLY: 2014-2018 / SEAT IBIZA ONLY: IV 2015-2017 / 1,4 TDI / VOLKSWAGEN POLO YEARS ONLY: 2014 -
<b>SE12005</b> MOTOR TAKOZU ARKA	SEAT IBIZA YEARS ONLY : 2002-2005
<b>SE20013001</b> ROT TAKIMI ÖN AKS SAĞ	ONLY: / 2001-2003
<b>SE20023001</b> ROT TAKIMI ÖN AKS SOL	ONLY: / 2001-2003
<b>SE2003</b> ROTBAŞI SAĞ	FOR VEHICLES WITH POWER STEERING
<b>SE20033002</b> ROT TAKIMI ÖN AKS SAĞ	FOR VEHICLES WITH POWER STEERING
<b>SE2004</b> ROTBAŞI SOL	FOR VEHICLES WITH POWER STEERING
<b>SE20043002</b> ROT TAKIMI ÖN AKS SOL	FOR VEHICLES WITH POWER STEERING
<b>SE3001</b> ROTMİLİ	ONLY: 2001-2003
<b>SK12002</b> AMORTİSÖR TAKOZU ARKA SOL VE SAĞ 1.2 / 1.4TSI / 1.6TDI / 1.2TDI	1.2 / 1.4TSI / 1.6TDI / 1.2TDI
<b>SK12003K</b> VİRAJ DEMİR LASTİĞİ SOL VE SAĞ RUBBER	2 PIECES IN 1 BOX
<b>SK12005</b> MOTOR TAKOZU ÖN SAĞ	FOR 1.0 TSI
<b>SK20033003</b> ROT TAKIMI ÖN AKS SAĞ RC788115	*T STEERING

Ürün Kodu	Bilgi Notu
<b>SK20033004</b> ROT TAKIMI ÖN AKS SAĞ RC788117	KOYO STEERING
<b>SK20043003</b> ROT TAKIMI SOL RC788114	*T STEERING
<b>SK20043004</b> ROT TAKIMI ÖN AKS SOL RC788116	KOYO STEERING
<b>SK2006</b> ROTBAŞI SAĞ	FACELIFT
<b>SK2007</b> ROTBAŞI SOL	FACELIFT
<b>SK3003</b> ROTMİLİ SAĞ-SOL 297	*T STEERING
<b>SK3004</b> ROTMİLİ SAĞ-SOL 300 RC7817	KOYO STEERING
<b>SK8001</b> SÜSPANSİYON KİT	SK3003 (X2) / AU4001 (X2) / OTHERS (X1)
<b>VW1012K</b> ROTİL ALT SAĞ-SOL 19 RD0515	WITH ENFORCEMENT METAL
<b>VW1013K</b> ROTİL	WITH ENFORCEMENT METAL
<b>VW1014</b> ROTİL ÖN ALT SAĞ Ø15,6 RB2536	WITH ENFORCEMENT METAL
<b>VW1028K</b> ROTİL ALT SAĞ RD0523	WITH ENFORCEMENT METAL
<b>VW1029K</b> ROTİL ALT SOL RD0524	WITH ENFORCEMENT METAL
<b>VW1051</b> ROTİL ALT SAĞ	FOR VEHICLES WITH ALUMINUM WHEEL BEARING
<b>VW1051</b> ROTİL ALT SAĞ	FOR VEHICLES WITH ALUMINUM WHEEL BEARING
<b>VW1052</b> ROTİL ALT SOL	FOR VEHICLES WITH ALUMINUM WHEEL BEARING
<b>VW1052</b> ROTİL ALT SOL	FOR VEHICLES WITH ALUMINUM WHEEL BEARING

Ürün Kodu	Bilgi Notu
<b>VW11043B</b> SALINCAK VE DENGİ KOLU BURCU SAĞ	WITHOUT BUSH
<b>VW11044B</b> SALINCAK VE DENGİ KOLU BURCU SOL	WITHOUT BUSH
<b>VW11055</b> SALINCAK VE DENGİ KOLU BURCU İÇ SOL VE SAĞ	ONLY FOR MEXICO MARKET
<b>VW11075</b> SALINCAK VE DENGİ KOLU BURCU ARKA SOL VE SAĞ	FORWARD and INNER
<b>VW11076</b> SALINCAK VE DENGİ KOLU BURCU ARKA SOL VE SAĞ	FORWARD and OUTER
<b>VW12020K</b> VİRAJ DEMİR LASTİĞİ SOL VE SAĞ RUBBER	2 PCS
<b>VW12028</b> MOTOR TAKOZU SOL VE SAĞ MOTOR TAKOZU	1,4 TDI -1,6 TDI
<b>VW12029</b> MOTOR TAKOZU SOL VE SAĞ MOTOR TAKOZU	1,4 TFSI -1,6 TFSI
<b>VW12030</b> MOTOR TAKOZU SOL VE SAĞ MOTOR TAKOZU ARKA	1,6-1,8
<b>VW12032</b> MOTOR TAKOZU SOL VE SAĞ MOTOR TAKOZU	A3: 2,0 FSI / ALTEA: 2,0 FSI / TOLEDO: 2,0 FSI / OCTAVIA: 2,0 FSI / CADDY: 2,0 FSI / GOLF: 2,0 TDI / GTI: 2,0 TDI / JETTA: 2,0 TDI / PASSAT: 2,0 FSI / TOURAN: 2,0 FSI
<b>VW12037K</b> VİRAJ DEMİR LASTİĞİ SOL VE SAĞ RUBBER	2 PCS
<b>VW12052K</b> VİRAJ DEMİR LASTİĞİ SOL VE SAĞ RUBBER	2 PCS
<b>VW12061K</b> AMORTİSÖR TAKOZU SOL VE SAĞ 2 PCS	2 PCS
<b>VW12064K</b> VİRAJ DEMİR LASTİĞİ SOL VE SAĞ RUBBER	2 PCS / D=Ø21mm
<b>VW12064K</b> VİRAJ DEMİR LASTİĞİ SOL VE SAĞ RUBBER	2 PCS / D=Ø21mm
<b>VW12065K</b> AMORTİSÖR TAKOZU ÖN SOL VE SAĞ 2 PCS	2 PCS
<b>VW12068K</b> TORSİYON BURCU ARKA SOL VE SAĞ	2 Pieces

Ürün Kodu	Bilgi Notu
<b>VW12086</b> RADYATÖR TAKOZU SOL VE SAĞ RADYATÖR ÜST LASTİĞİ	FOR RADIATOR UPPER PART
<b>VW12109K</b> AMORTİSÖR TAKOZU SOL VE SAĞ 2 PCS	2 PCS
<b>VW12111K</b> VİRAJ DEMİR LASTİĞİ SOL VE SAĞ RUBBER	2 PCS
<b>VW12117K</b> VİRAJ DEMİR LASTİĞİ SOL VE SAĞ RUBBER	2 PCS
<b>VW12137</b> VİRAJ DEMİR LASTİĞİ	Ø17mm
<b>VW12137K</b> VİRAJ DEMİR LASTİĞİ	2 PIECES in 1 BOX / Ø17mm
<b>VW12801</b> AMORTİSÖR TAKOZU SOL VE SAĞ KIT = VW12115 AND VW12109	KIT = VW12115 and VW12109
<b>VW13002K</b> DİREKSİYON KÖRÜĞÜ SOL VE SAĞ 2 PIECES	2 Pieces
<b>VW13006K</b> DİREKSİYON KÖRÜĞÜ SOL VE SAĞ 2 PIECES	2 Pieces
<b>VW14003</b> AKS KÖRÜĞÜ +KELEPÇE+YAĞ. DIŞ	SET = BELOW, CLAMPING CLIP and MOLYBDENUM GREASE / OUTER
<b>VW14009</b> AKS KÖRÜĞÜ +KELEPÇE+YAĞ. DIŞ	SET = BELOW, CLAMPING CLIP and MOLYBDENUM GREASE / OUTER
<b>VW14011</b> AKS KÖRÜĞÜ +KELEPÇE+YAĞ. İÇ	SET = BELOW, CLAMPING CLIP and MOLYBDENUM GREASE / INNER
<b>VW14013</b> AKS KÖRÜĞÜ +KELEPÇE+YAĞ. YAĞ+KELEPÇE	SET = BELOW, CLAMPING CLIP and MOLYBDENUM GREASE
<b>VW14014</b> AKS KÖRÜĞÜ +KELEPÇE+YAĞ. YAĞ+KELEPÇE	SET = BELOW, CLAMPING CLIP and MOLYBDENUM GREASE
<b>VW20063003</b> ROT TAKIMI SAĞ RD088116	MANUAL STEERING
<b>VW20063004</b> ROT TAKIMI ÖN AKS SAĞ	POWER STEERING
<b>VW20063015</b> ROT TAKIMI ÖN AKS SAĞ RD088165	MANUAL STEERING

Ürün Kodu	Bilgi Notu
<b>VW20063016</b> ROT TAKIMI ÖN AKS SAĞ RD088163	POWER STEERING
<b>VW20073003</b> ROT TAKIMI SOL RD088115	MANUAL STEERING
<b>VW20073004</b> ROT TAKIMI SOL RD088118	POWER STEERING
<b>VW20073015</b> ROT TAKIMI ÖN AKS SOL RD088166	MANUAL STEERING
<b>VW20073016</b> ROT TAKIMI ÖN AKS SOL RD088145	POWER STEERING
<b>VW2022</b> ROTBAŞI SAĞ RD0336	POWER STEERING
<b>VW2023</b> ROTBAŞI SOL RD0335	POWER STEERING
<b>VW2031</b> ROTBAŞI SAĞ	FOR VEHICLES WITH DYNAMIC STEERING
<b>VW2032</b> ROTBAŞI SOL	FOR VEHICLES WITH DYNAMIC STEERING
<b>VW3003</b> ROTMİLİ SAĞ-SOL RD0817	MANUAL STEERING
<b>VW3004</b> ROTMİLİ ÖN SAĞ - SOL 338 RD0887	POWER STEERING
<b>VW3015</b> ROTMİLİ SAĞ-SOL HİDROLİK 309 RD0867	POWER STEERING
<b>VW3016</b> ROTMİLİ SAĞ-SOL MANUEL 321 RD0864	MANUAL STEERING
<b>VW4015K</b> Z ROT SOL VE SAĞ METAL	WITH NUT and SCREW
<b>VW4035</b> Z ROT ARKA PLASTİK	TRIM LEVEL : MULTILINK REAR AXLE
<b>VW60066007K</b> SALINCAK ÖN	UNASSEMBLED BALL JOINT
<b>VW600674008K</b> SALINCAK ÖN	UNASSEMBLED BALL JOINT and LINK STABILIZER



Ürün Kodu	Bilgi Notu
<b>VW6016</b> SALINCAK ÖN SAĞ RD10227	ONLY: GASOLINE
<b>VW6016J</b> SALINCAK ÖN ALT SAĞ S737	ONLY: GASOLINE
<b>VW6017</b> SALINCAK ÖN SOL RD10226	ONLY: GASOLINE
<b>VW6017J</b> SALINCAK ÖN ALT SOL S738	ONLY: GASOLINE
<b>VW6018</b> SALINCAK ÖN SAĞ RB30219	ONLY: DIESEL
<b>VW6018J</b> SALINCAK ÖN SAĞ RB30211	ONLY: DIESEL
<b>VW6019</b> SALINCAK ÖN SOL RB30218	ONLY: DIESEL
<b>VW6019J</b> SALINCAK ÖN SOL RB30212	ONLY: DIESEL
<b>VW6063</b> SALINCAK ÖN ALT SAĞ	1.0 TSI
<b>VW6063</b> SALINCAK ÖN ALT SAĞ	1.0 TSI
<b>VW6063J</b> SALINCAK ÖN ALT SAĞ	1.0 TSI
<b>VW6063J</b> SALINCAK ÖN ALT SAĞ	1.0 TSI
<b>VW6064</b> SALINCAK ÖN ALT SOL	1.0 TSI
<b>VW6064</b> SALINCAK ÖN ALT SOL	1.0 TSI
<b>VW6064J</b> SALINCAK ÖN ALT SOL	1.0 TSI
<b>VW6064J</b> SALINCAK ÖN ALT SOL	1.0 TSI
<b>VW6089</b> SALINCAK VE DENGE KOLU ÖN ALT SAĞ SAC LEVHA	FOR VEHICLES WITH ALUMINUM WHEEL BEARING

Ürün Kodu	Bilgi Notu
<b>VW6090</b> SALINCAK VE DENGE KOLU ÖN ALT SOL SAC LEVHA	FOR VEHICLES WITH ALUMINUM WHEEL BEARING
<b>VW8001</b> SÜSPANSİYON KİT ÖN	AU3001 (X2) / VW4011 (X2) / OTHERS (X1)
<b>VW8002</b> SÜSPANSİYON KİT ÖN	VW3009 (X2) / VW4014 (X2) / OTHERS (X1)
<b>VW8003</b> SÜSPANSİYON KİT ÖN	KIT = AU1014 (X1) / AU1015 (X1) / VW4011 (X2) / AU11002 (X2) / AU11005 (X2)
<b>VW9005</b> SALINCAK ARKA ALT ÖNDEN	FORWARD