

RIW

STEERING & SUSPENSION
MANUFACTURER



SKODA PRODUCT CATALOG



Products

- Ball Joint
- Tie Rod End
- Axial Joint
- Link Stabilizer
- Control Arm
- Center Rod
- Stabilizer Mounting
- Suspension Kit
- Bush
- Tie Rod Assembly
- Mounting
- Steering Bellow
- Axle Bellow



Hakkımızda

RIW, otomotiv yedek parça yenileme sektöründe binek ve hafif ticari araçların süspansiyon ve direksiyon parçalarını yüksek kalitede üreten ve son kullanıcının aracını güvenle kullanmasını amaçlayan ayrıca otomotiv endüstrisine ve ülke ekonomisine fayda sağlamayı kendine ilke edinen bir organizasyondur. Rotil, rotbaşı, rotmili, rot-takımı, zrot, askı rotu, ara rot, denge kolu, salıncak, burç, kauçuk ve takoz ürünlerinin montaj ve üretimlerini gerçekleştiren RIW, dünyadaki en geniş ürün çeşitliliğine sahip süspansiyon ve direksiyon parçaları üreticilerinden biridir.

Ürün çeşitliliğinin genişliği, yüksek ürün kalitesi, uygun fiyatları ve müşteri odaklı çalışmaları sonucunda Türkiye'nin en büyük yedek parça firmaları arasında yer almaktadır. Binek ve hafif ticari araçların süspansiyon ve direksiyon parçaları üretiminde Araştırma ve Geliştirme odaklı çalışmalarını en ileri ve teknolojik şartlarda yürütülmesiyle RIW Türkiye'nin en modern yedek parça üreticisidir.

RIW, firma kültüründe, teknoloji, kalite ve müşteri memnuniyetini ön planda tutularak, Türkiye'de ve dünyanın birçok ülkesinde pazarın güvenle tedarik ettiği bir markadır. RIW, modern üretim tesislerinde bulunan son teknoloji makina parkı avantajıyla tasarımdan üretime, üretimden kaliteye, paketlenmeden sevkiyata, pazarlamadan satışa bütün operasyonel aşamaların yanı sıra satış sonrası hizmetlerini ve bütün bunları sağlarken göz önünde bulundurduğu çalışan memnuniyeti ve güvenliğini her zaman iyiye ve ileriye götürme prensibi sayesinde Dünya genelinde 60 'ın üzerinde ülkede saygı değer bir marka olmayı başarmıştır.

Misyon

Dünya otomotiv yenileme sektörüne yüksek kalitede ve pazarda her zaman ilk kez geliştirilen ürünleri sunmak ve ayrıca pazardaki ürün kalitesini yükseltmek.

Vizyon

İleri teknoloji ve sektörel deneyimin ortaya çıkardığı "RIW Standartlarından" bütün dünyanın faydalanması.

Üretim Stratejisi

Ürün dizaynı, kalıp tasarımı, talaşlı imalat, sıcak ve soğuk dövme, alüminyum dövme, dikey ve yatay kol işleme, salıncak imalatı, kaynak, boyama, kaplama ve paketlenmeden oluşan çeşitli üretim aşamaları hemen hemen her bölümün kendi tesisinde RIW mühendislerinin kontrolünde gerçekleşir. RIW üretimdeki her aşamayı farklı bir ünite olarak kabul eder ve müşteriye en hızlı ve en kaliteli ürünü sunmak için her birimin kendi planlamasını ayrı bir birim olarak hareket etmesi tezini savunur. Bu sayede büyük sermayelere ulaşmanın zor olduğu rekabetçi Pazar şartlarında RIW yatırımlarını kalitenin kontrolü ve yükseltilmesi doğrultusunda gerçekleştirir.

Üretimdeki her aşamanın bir çatı altında toplanmasını amaçlayan zihniyetin tam tersine RIW deneyimli mühendisleri sayesinde hammadde ve yarı mamül tedarikçilerinin sürekli denetlenmesini sağlar ve bu sayede kaliteyi her zaman kontrol altında tutar. Bu sistemle kalite testlerinin her aşamada uygulanması için kullanılan son teknoloji makine ve test cihazları sayesinde RIW müşterisine her zaman %100 kontrol edilmiş ürünler sunar ve ayrıca hem hata riskini sıfıra indirir hem de üretilen mamüllerin maliyetlerini düşürerek müşterisine en yüksek kaliteyi en uygun ve rekabetçi fiyatlarda sunmayı hedefler.

Toplam Kalite Anlayışı

Toplam kalite anlayışını kendine amaç edinen RIW, yapılan yatırımlar ve kalite çalışmaları sonucunda, üretim kapasitesini devamlı arttırmış ve dünya pazarında aranan bir marka haline gelmiştir. Güvenlik parçaları üreticisi olmak bilinciyle hareket eden RIW, yüksek kalitedeki ürünlerini Avrupa, Kuzey Afrika, Ortadoğu, Avustralya, Kuzey ve Güney Amerika da yer alan birçok ülkeye aktif olarak ihraç etmektedir.

Üretimin başlangıcından bitimine kadar olan tüm aşamalarda RIW, ürünlerinin kalitesini yakından takip etmekte ve müşterilerine güvenilir ve yüksek kaliteli ürünlerin sunulduğundan emin olmaktadır. Doğru kaliteyi buluna kadar bütün testler ve işlemler, yüksek deneyime sahip RIW mühendisleri tarafından uygulanmaktadır.

Hakkımızda

RIW, otomotiv yedek parça yenileme sektöründe binek ve hafif ticari araçların süspansiyon ve direksiyon parçalarını yüksek kalitede üreten ve son kullanıcının aracını güvenle kullanmasını amaçlayan ayrıca otomotiv endüstrisine ve ülke ekonomisine fayda sağlamayı kendine ilke edinen bir organizasyondur. Rotil, rotbaşı, rotmili, rot-takımı, zrot, askı rotu, ara rot, denge kolu, salıncak, burç, kauçuk ve takoz ürünlerinin montaj ve üretimlerini gerçekleştiren RIW, dünyadaki en geniş ürün çeşitliliğine sahip süspansiyon ve direksiyon parçaları üreticilerinden biridir.

Ürün çeşitliliğinin genişliği, yüksek ürün kalitesi, uygun fiyatları ve müşteri odaklı çalışmaları sonucunda Türkiye'nin en büyük yedek parça firmaları arasında yer almaktadır. Binek ve hafif ticari araçların süspansiyon ve direksiyon parçaları üretiminde Araştırma ve Geliştirme odaklı çalışmalarını en ileri ve teknolojik şartlarda yürütülmesiyle RIW Türkiye'nin en modern yedek parça üreticisidir.

RIW, firma kültüründe, teknoloji, kalite ve müşteri memnuniyetini ön planda tutularak, Türkiye'de ve dünyanın birçok ülkesinde pazarın güvenle tedarik ettiği bir markadır. RIW, modern üretim tesislerinde bulunan son teknoloji makina parkı avantajıyla tasarımdan üretime, üretimden kaliteye, paketlenmeden sevkiyata, pazarlamadan satışa bütün operasyonel aşamaların yanı sıra satış sonrası hizmetlerini ve bütün bunları sağlarken göz önünde bulundurduğu çalışan memnuniyeti ve güvenliğini her zaman iyiye ve ileriye götürme prensibi sayesinde Dünya genelinde 60 'ın üzerinde ülkede saygı değer bir marka olmayı başarmıştır.

Misyon

Dünya otomotiv yenileme sektörüne yüksek kalitede ve pazarda her zaman ilk kez geliştirilen ürünleri sunmak ve ayrıca pazardaki ürün kalitesini yükseltmek.

Vizyon

İleri teknoloji ve sektörel deneyimin ortaya çıkardığı "RIW Standartlarından" bütün dünyanın faydalanması.

Üretim Stratejisi

Ürün dizaynı, kalıp tasarımı, talaşlı imalat, sıcak ve soğuk dövme, alüminyum dövme, dikey ve yatay kol işleme, salıncak imalatı, kaynak, boyama, kaplama ve paketlenmeden oluşan çeşitli üretim aşamaları hemen hemen her bölümün kendi tesisinde RIW mühendislerinin kontrolünde gerçekleşir. RIW üretimdeki her aşamayı farklı bir ünite olarak kabul eder ve müşteriye en hızlı ve en kaliteli ürünü sunmak için her birimin kendi planlamasını ayrı bir birim olarak hareket etmesi tezini savunur. Bu sayede büyük sermayelere ulaşmanın zor olduğu rekabetçi Pazar şartlarında RIW yatırımlarını kalitenin kontrolü ve yükseltilmesi doğrultusunda gerçekleştirir.

Üretimdeki her aşamanın bir çatı altında toplanmasını amaçlayan zihniyetin tam tersine RIW deneyimli mühendisleri sayesinde hammadde ve yarı mamül tedarikçilerinin sürekli denetlenmesini sağlar ve bu sayede kaliteyi her zaman kontrol altında tutar. Bu sistemle kalite testlerinin her aşamada uygulanması için kullanılan son teknoloji makine ve test cihazları sayesinde RIW müşterisine her zaman %100 kontrol edilmiş ürünler sunar ve ayrıca hem hata riskini sıfıra indirir hem de üretilen mamüllerin maliyetlerini düşürerek müşterisine en yüksek kaliteyi en uygun ve rekabetçi fiyatlarda sunmayı hedefler.

Toplam Kalite Anlayışı

Toplam kalite anlayışını kendine amaç edinen RIW, yapılan yatırımlar ve kalite çalışmaları sonucunda, üretim kapasitesini devamlı arttırmış ve dünya pazarında aranan bir marka haline gelmiştir. Güvenlik parçaları üreticisi olmak bilinciyle hareket eden RIW, yüksek kalitedeki ürünlerini Avrupa, Kuzey Afrika, Ortadoğu, Avustralya, Kuzey ve Güney Amerika da yer alan birçok ülkeye aktif olarak ihraç etmektedir.

Üretimin başlangıcından bitimine kadar olan tüm aşamalarda RIW, ürünlerinin kalitesini yakından takip etmekte ve müşterilerine güvenilir ve yüksek kaliteli ürünlerin sunulduğundan emin olmaktadır. Doğru kaliteyi buluna kadar bütün testler ve işlemler, yüksek deneyime sahip RIW mühendisleri tarafından uygulanmaktadır.

- The codes which has 6 characters are suspension parts (Additional codes are exceptional)
- The codes which has 7 characters are rubber parts (Additional codes are exceptional)
- There is no any specific code for Rod Assembly.
- Rod Assembly codes are the combine of Tie Rod End and Axial Joint.
- Same parts which are used at the different cars might have the same code.

PE 6 001 J

Brand

AC ACURA	DC DACIA	IS ISUZU	LE LEYLAND	PE PEUGEOT	SM SMART
AF ALFA ROMEO	DW DAEWOO	IV IVECO	LC LINCOLN	PO PORSCHE	SY SSANGYONG
AU AUDI	DH DAIHATSU	JG JAGUAR	LO LOTUS	PR PROTON	SU SUBARU
BW BMW	DO DODGE	JP JEEP	MZ MAZDA	RE RENAULT	SZ SUZUKI
BU BUICK	FI FIAT	KI KIA	ME MERCEDES	RR ROLLS-ROYCE	TO TOYOTA
CD CADILLAC	FO FORD	LD LADA	MC MINI COOPER	RO ROVER	VA VAUXHALL
CV CHEVROLET	HN HONDA	LR LAND ROVER	MI MITSUBISHI	SA SAAB	VW VOLKSWAGEN
CY CHRYSLER	HY HYUNDAI	LV LDV	NS NISSAN	SE SEAT	VO VOLVO
CI CITROËN	IK IKCO	LX LEXUS	OP OPEL	SK SKODA	

Product Group

1 BALL JOINT	7 CENTER ROD & DRAG LINK	23 TIE ROD ASSEMBLY
2 TIE ROD END	8 SUSPENSION KITS	12 MOUNTING & RUBBER SUPPORT
3 AXIAL JOINT (INNER TIE ROD)	9 REAR WISHBONE AND CONTROL ARM	128 MOUNTING or RUBBER SUPPORT KIT
4 LINK STABILIZER	10 BUSH	13 BELLOW STEERING
5 CONTROL ARM	11 BUSH	14 BELLOW DRIVE SHAFT
6 WISHBONE	118 REPAIR & BUSH KIT	

Numbers

001 Any Number ■

Option

ADDITIONALS CODES AND MEANINGS

K K FOR BALL JOINTS	B B FOR WISHBONE and CONTROL ARMS
VW1012K 1 = BALL JOINT K = WITH EXTRA ACCESSORIES	BW5005B 5 = CONTROL ARM B = WITHOUT BUSHING
VW1012 1 = BALL JOINT	BW5005 5 = CONTROL ARM (The similar as OE part)
J J FOR WISHBONES	K K FOR MOUNTINGS (RUBBER PARTS)
PE6001J 6 = WISHBONE J = WITHOUT BALL JOINT	CV12005K 12 = MOUNTING K = KIT, 2 PIECES or WITH EXTRA ACCESSORIES
PE6001 6 = WISHBONE (The similar as the OE part)	CV12005 12 = MOUNTING (The similar as OE part)
K K FOR WISHBONES or CONTROL ARMS (5,6 or 9)	A THE PRODUCT HAS DIFFERENT OPTION
BW6005K 6 = WISHBONE K = WITH EXTRA ACCESSORIES	FO4030A 4 = LINK STABILIZER A = OPTION (metal, rubber), plastic etc)
BW6005 6 = WISHBONE	FO4030 4 = LINK STABILIZER (The similar as OE part)







RIW®

SKODA

100 - 120 - 130L
1970 - 1991

Resim	Ürün Kodu ve Açıklaması	Detay	OEM
	SK2005 ROTBAŞI M12X1 RHT	Ağırlık : 0,324 kg / 0.714 lb Uzunluk : 79 mm / 3.11 inch Gövde Diş Çapı : M12X1 Aşık Diş Çapı : M10X1,25 Aşık Konik Çapı : Ø11	111500440, 111500441
	FI13013 DİREKSİYON KÖRÜĞÜ SAĞ	Ağırlık : 0.1 kg / 0.220 lb	114509823, 4239459 4371156, 7583243
	FI13014 DİREKSİYON KÖRÜĞÜ SOL	Ağırlık : 0.062 kg / 0.137 lb	114509823, 4239459 4371156, 7583243 9939039

CITIGO
2011 -

Resim	Ürün Kodu ve Açıklaması	Detay	OEM
	SK1025 ROTİL SAĞ	Ağırlık : 0,59 kg / 1.301 lb Konik Ölçüsü : Ø15 Bağlantı Delik Çapı : Ø10,5 Aşık Diş Çapı : M12X1,5	5U0407366A, 6R0407366 6R0407366A, 6R0407366B
	SK1026 ROTİL ÖN ALT SOL Ø15	Ağırlık : 0,59 kg / 1.301 lb Konik Ölçüsü : Ø15 Bağlantı Delik Çapı : Ø10,5 Aşık Diş Çapı : M12X1,5	5U0407365A, 6R0407365 6R0407365A, 6R0407365B
	VW2024 ROTBAŞI SAĞ 94 MM	Ağırlık : 0,435 kg / 0.959 lb Uzunluk : 93,5 mm / 3.68 inch Gövde Diş Çapı : M14X1,5 Aşık Diş Çapı : M12X1,5 Aşık Konik Çapı : Ø13,4	1S0423812A
	VW2025 ROTBAŞI SOL 94 MM	Ağırlık : 0,435 kg / 0.959 lb Uzunluk : 93,5 mm / 3.68 inch Gövde Diş Çapı : M14X1,5 Aşık Diş Çapı : M12X1,5 Aşık Konik Çapı : Ø13,4	1S0423811A
	VW3020 ROTMİLİ SAĞ-SOL <<ÖZELLİK>> 306MM	Ağırlık : 0,576 kg / 1.270 lb Uzunluk : 306 mm / 12.05 inch Gövde Diş Çapı : M14X1,5 Aşık Diş Çapı : M14X1,5	1S0423810A
	VW20243020 ROT TAKIMI ÖN SAĞ	Ağırlık : 1,1 kg / 2.425 lb Rotbaşı : VW2024 Rotmilî : VW3020	1S0423810A S1, 1S0423810A
	VW20253020 ROT TAKIMI ÖN SOL	Ağırlık : 1,1 kg / 2.425 lb Rotbaşı : VW2024 Rotmilî : VW3020	1S0423810A S2, 1S0423810A

* Bu sayfada ve katalogdaki tüm araçların adları, markaları, modelleri, sembolleri, logoları, orjinal numaraları (oe) ve diğer üçüncü parti numaraları sadece referans amaçlı kullanılmaktadır.

CITIGO
2011 -

Resim	Ürün Kodu ve Açıklaması	Detay	OEM
	AU4028 Z ROT ÖN	Ağırlık : 0,368 kg / 0.811 lb Malzeme Türü : Metal Uzunluk : 270 mm / 10.63 inch Aşık Dış Çapı : M10X1,5	6Q0411315L, 6Q0411315N 8Z0411315D
	VW6047 SALINCAK ÖN SAĞ	Ağırlık : 2,65 kg / 5.842 lb Malzeme Türü : Sac Metal	1S0407152*
	VW6047J SALINCAK ÖN SAĞ	Ağırlık : 2,06 kg / 4.542 lb Malzeme Türü : Sac Metal	1S0407152
	VW6048 SALINCAK ÖN SOL	Ağırlık : 2,65 kg / 5.842 lb Malzeme Türü : Sac Metal	1S0407151*
	VW6048J SALINCAK ÖN SOL	Ağırlık : 2,06 kg / 4.542 lb Malzeme Türü : Sac Metal	1S0407151
	AU11002 SALINCAK VE DENGE KOLU BURCU ÖN SOL VE SAĞ B22117	Şasi (Ön / Arka) : ÖN Yön : Sol Ve Sağ Ağırlık : 0,108 kg / 0.238 lb	1J0407181, 1J0407181A
	AU11005 SALINCAK VE DENGE KOLU BURCU ÖN ORTA SOL VE SAĞ B40115	Şasi (Ön / Arka) : ÖN Yön : Orta Sol Ve Sağ Ağırlık : 0,111 kg / 0.245 lb Not : VW6014 - VW60614J	191407182, 357407182 357407182F
	SK12004 TORSİYON BURCU ARKA SOL VE SAĞ	Şasi (Ön / Arka) : ARKA Yön : Sol Ve Sağ Ağırlık : 0,335 kg / 0.739 lb	1S0501541B, 1S0501541F
	VW12061 AMORTİSÖR TAKOZU SOL VE SAĞ AMORTİSÖR TAKOZU	Yön : Sol Ve Sağ Ağırlık : 0.27 kg / 0.595 lb Not : AMORTİSÖR TAKOZU	1H0412365A, 1J0412249 1J0412331BS, 1J0412331C
	VW12061A AMORTİSÖR TAKOZU SOL VE SAĞ AMORTİSÖR RULMANI	Yön : Sol Ve Sağ Ağırlık : 0.08 kg / 0.176 lb Not : AMORTİSÖR RULMANI	1J0412249, 1J0412249C 357412249, 357412249A 4503300051, 7201688 7201848, 95VW3K031AA
	VW12061K AMORTİSÖR TAKOZU SOL VE SAĞ 2 PCS	Yön : Sol Ve Sağ Ağırlık : 0.7 kg / 1.543 lb Not : 2 PCS	1H0412365A, 1J0412249 1J0412331BS, 1J0412331C

* Bu sayfada ve katalogdaki tüm araçların adları, markaları, modelleri, sembolleri, logoları, orjinal numaraları (oe) ve diğer üçüncü parti numaraları sadece referans amaçlı kullanılmaktadır.





CITIGO
2011 -

Resim	Ürün Kodu ve Açıklaması	Detay	OEM
	VW12103 AMORTİSÖR TAKOZU SOL VE SAĞ AMORTİSÖR ÜST TAKOZU	Yön : Sol Ve Sağ Ağırlık : 0.23 kg / 0.507 lb Not : AMORTİSÖR ÜST TAKOZU	1J0412331B, 1J0412331C
	SE12006 ŞANZİMAN TAKOZU SOL	Yön : Sol Ağırlık : 0,760 kg / 1.676 lb	1S0199555A
	VW12036 SÜSPANSİYON TAKOZU SOL VE SAĞ ARKA SÜSPANSİYON TAKOZU	Yön : Sol Ve Sağ Ağırlık : 1.591 kg / 3.508 lb Not : ARKA SÜSPANSİYON TAKOZU	6Q0512131B
	VW12086 RADYATÖR TAKOZU SOL VE SAĞ RADYATÖR ÜST LASTİĞİ	Yön : Sol Ve Sağ Ağırlık : 0.024 kg / 0.053 lb Not : RADYATÖR ÜST LASTİĞİ	1K0121367F

ELROQ
2021 -

Resim	Ürün Kodu ve Açıklaması	Detay	OEM
	VW2037 ROTBAŞI SOL VE SAĞ 124	Ağırlık : 0,525 kg / 1.157 lb Uzunluk : 124 mm / 4.88 inch	1EA423811B

ELROQ
2025 -

Resim	Ürün Kodu ve Açıklaması	Detay	OEM
	VW1046 ROTİL ALT	Ağırlık : 0,615 kg / 1.356 lb	1EA407365A
	VW2037 ROTBAŞI SOL VE SAĞ 124	Ağırlık : 0,525 kg / 1.157 lb Uzunluk : 124 mm / 4.88 inch	1EA423811B
	VW3029 ROTMİLİ ÖN	Ağırlık : 0,915 kg / 2.017 lb Uzunluk : 433 mm / 17.05 inch	1EA423810C
	VW4040 Z ROT ÖN	Ağırlık : 0,475 kg / 1.047 lb Uzunluk : 338 mm / 13.31 inch	1EA411315C

* Bu sayfada ve katalogdaki tüm araçların adları, markaları, modelleri, sembolleri, logoları, orjinal numaraları (oe) ve diğer üçüncü parti numaraları sadece referans amaçlı kullanılmaktadır.

FABIA
I 6Y2
1999 - 2006

Resim	Ürün Kodu ve Açıklaması	Detay	OEM
	SK1023 ROTİL SAĞ RD0530	Ağırlık : 0,46 kg / 1.014 lb Konik Ölçüsü : Ø15 Bağlantı Delik Çapı : Ø8,5 Aşık Diş Çapı : M12X1,5	6Q0407366A, 6Q0407366B 6Q0407366E, 6Q0407366M 8Z0407366A
	SK1023K ROTİL ÖN ALT SAĞ Ø15 KIT	Ağırlık : 0,5 kg / 1.102 lb Konik Ölçüsü : Ø15 Bağlantı Delik Çapı : Ø8,5 Aşık Diş Çapı : M12X1,5	6Q0407366A*, 6Q0407366A 6Q0407366B*, 6Q0407366E* 6Q0407366M*, 6Q0407366M 8Z0407366A*
	SK1024 ROTİL SOL RD0531	Ağırlık : 0,46 kg / 1.014 lb Konik Ölçüsü : Ø15 Bağlantı Delik Çapı : Ø8,5 Aşık Diş Çapı : M12X1,5	6Q0407365A, 6Q0407365B 6Q0407365E, 6Q0407365M 8Z0407365A
	SK1024K ROTİL SOL	Ağırlık : 0,5 kg / 1.102 lb Konik Ölçüsü : Ø15 Bağlantı Delik Çapı : Ø8,5 Aşık Diş Çapı : M12X1,5	6Q0407365A*, 6Q0407365A 6Q0407365B*, 6Q0407365E* 6Q0407365E, 6Q0407365M* 6Q0407365M, 8Z0407365A*
	SK2003 ROTBAŞI SAĞ RC7314	Ağırlık : 0,377 kg / 0.831 lb Uzunluk : 93,5 mm / 3.68 inch Gövde Diş Çapı : M14X1,5 Aşık Diş Çapı : M12X1,5 Aşık Konik Çapı : Ø13,5	5Z0423812, 6Q0419812C 6Q0423812, 6Q0423812A 6Q0423812C, 6Q0423812D 6R0423812, 8Z0423811A
	SK2004 ROTBAŞI SOL RC7313	Ağırlık : 0,382 kg / 0.842 lb Uzunluk : 93 mm / 3.66 inch Gövde Diş Çapı : M14X1,5 Aşık Diş Çapı : M12X1,5 Aşık Konik Çapı : Ø13,5	5Z0423811, 6Q0419811C 6Q0423811, 6Q0423811A 6Q0423811C, 6Q0423811D 6R0423811, 8Z0423812A
	SK3003 ROTMİLİ SAĞ-SOL 297	Ağırlık : 0,552 kg / 1.217 lb Uzunluk : 297 mm / 11.69 inch Gövde Diş Çapı : M14X1,5 Aşık Diş Çapı : M14X1,5	6Q0 423 821 B, 6Q0423821B 6X0422803, 6X0422804 6X0422807, 6X0422821
	SK3004 ROTMİLİ SAĞ-SOL 300 RC7817	Ağırlık : 0,536 kg / 1.182 lb Uzunluk : 300 mm / 11.81 inch Gövde Diş Çapı : M16X1,5 Aşık Diş Çapı : M14X1,5	6Q0423803A, 6Q0423804A 6Q0-423-810-C, 6Q0423821A 6Q0423821C, 6Q0423821G
	SK3007 ROTMİLİ SAĞ-SOL	Ağırlık : 0,561 kg / 1.237 lb Uzunluk : 311 mm / 12.24 inch Gövde Diş Çapı : M14X1,5 Aşık Diş Çapı : M14X1,5	6Q0419803B, 6Q0419803D 6Q0419803F, 6Q0419804B 6Q0419804D, 6Q0419804F

SK8001 / Süspansiyon Kit

FABIA

I 6Y2

1999 - 2006

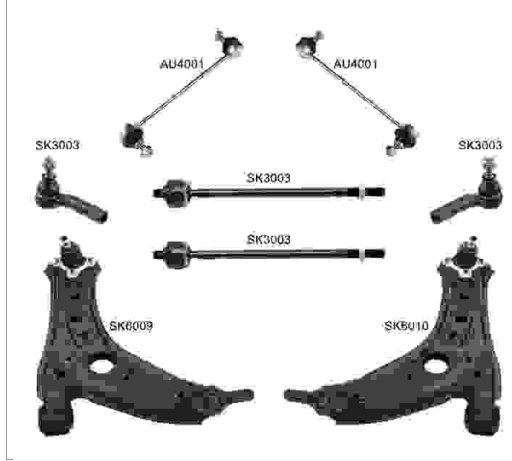











Kit Parçaları

Resim	Ürün Kodu / Adı	OEM	OEM	Ürün Kodu / Adı	Resim
	AU4001 Z Rot Sol Ve Sağ Metal Rb2911	893407465, 893407465A 8A0407465, 8A0407465B 8A0407465C	5Z0423812, 6Q0419812C 6Q0423812, 6Q0423812A 6Q0423812C, 6Q0423812D 6R0423812, 8Z0423811A	SK2003 Rotbaşı Sağ Rc7314	
	SK2004 Rotbaşı Sol Rc7313	5Z0423811, 6Q0419811C 6Q0423811, 6Q0423811A 6Q0423811C, 6Q0423811D 6R0423811, 8Z0423812A	6Q0 423 821 B, 6Q0423821B 6X0422803, 6X0422804 6X0422807, 6X0422821	SK3003 Rotmili Sağ-sol 297	
	SK6009 Salıncak Ön Alt Sağ Rd1035	6N0407151, 6Q0407151D* 6Q0407151D, 6Q0407151E* 6Q0407151E, 6Q0407151L 6Q0407151Z, 6Q0407366A*	6N040711, 6Q0407151D* 6Q0407151D, 6Q0407151E* 6Q0407151E, 6Q0407151L 6Q0407151Z, 6Q0407365A*	SK6010 Salıncak Ön Alt Sol Rd1036	

* Bu sayfada ve katalogdaki tüm araçların adları, markaları, modelleri, sembolleri, logoları, orjinal numaraları (oe) ve diğer üçüncü parti numaraları sadece referans amaçlı kullanılmaktadır.

FABIA
I 6Y2
1999 - 2006

Resim	Ürün Kodu ve Açıklaması	Detay	OEM
	SK20033003 ROT TAKIMI ÖN AKS SAĞ RC788115	Ağırlık : 1,021 kg / 2.251 lb Rotbaşı : SK2003 Rotmili : SK3003	6Q0422804B, 6Q0423804B
	SK20033004 ROT TAKIMI ÖN AKS SAĞ RC788117	Ağırlık : 0,915 kg / 2.017 lb Rotbaşı : SK2003 Rotmili : SK3004	6Q0422804G, 6Q0423804A
	SK20033007 ROT TAKIMI ÖN AKS SAĞ	Ağırlık : 0,96 kg / 2.116 lb Rotbaşı : SK2003 Rotmili : SK3007	
	SK20043003 ROT TAKIMI SOL RC788114	Ağırlık : 0,932 kg / 2.055 lb Rotbaşı : SK2004 Rotmili : SK3003	6Q0422803B, 6Q0423803B
	SK20043004 ROT TAKIMI ÖN AKS SOL RC788116	Ağırlık : 0,903 kg / 1.991 lb Rotbaşı : SK2004 Rotmili : SK3004	6Q0422803G, 6Q0423803A
	SK20043007 ROT TAKIMI ÖN AKS SOL	Ağırlık : 0,96 kg / 2.116 lb Rotbaşı : SK2004 Rotmili : SK3007	
	AU4001 Z ROT SOL VE SAĞ METAL RB2911	Ağırlık : 0,357 kg / 0.787 lb Malzeme Türü : Metal Uzunluk : 270 mm / 10.63 inch Aşık Diş Çapı : M10X1,5	893407465, 893407465A 8A0407465, 8A0407465B 8A0407465C
	AU4001A Z ROT ÖN PLASTİK	Ağırlık : 0,295 kg / 0.650 lb Malzeme Türü : Plastik Uzunluk : 317 mm / 12.48 inch	893407465, 893407465A 8A0407465, 8A0407465B 8A0407465C
	AU4028 Z ROT ÖN	Ağırlık : 0,368 kg / 0.811 lb Malzeme Türü : Metal Uzunluk : 270 mm / 10.63 inch Aşık Diş Çapı : M10X1,5	6Q0411315L, 6Q0411315N 8Z0411315D
	SK6009 SALINCAK ÖN ALT SAĞ RD1035	Ağırlık : 2,676 kg / 5.900 lb Malzeme Türü : Sac Metal	6N0407151, 6Q0407151D* 6Q0407151D, 6Q0407151E* 6Q0407151E, 6Q0407151L 6Q0407151Z, 6Q0407366A*
	SK6009J SALINCAK ÖN ALT RD10211	Ağırlık : 2,626 kg / 5.789 lb Malzeme Türü : Sac Metal	6Q0407151D, 6Q0407151E 6Q0407151L

* Bu sayfada ve katalogdaki tüm araçların adları, markaları, modelleri, sembolleri, logoları, orjinal numaraları (oe) ve diğer üçüncü parti numaraları sadece referans amaçlı kullanılmaktadır.

FABIA
I 6Y2
1999 - 2006

Resim	Ürün Kodu ve Açıklaması	Detay	OEM
	SK6009K SALINCAK ÖN ALT SAĞ	Ağırlık : 3,13 kg / 6.900 lb Malzeme Türü : Sac Metal	6N0407151, 6Q0407151D 6Q0407151E, 6Q0407151L 6Q0407151Z
	SK6010 SALINCAK ÖN ALT SOL RD1036	Ağırlık : 3,13 kg / 6.900 lb Malzeme Türü : Sac Metal	6N040711, 6Q0407151D* 6Q0407151D, 6Q0407151E* 6Q0407151E, 6Q0407151L 6Q0407151Z, 6Q0407365A*
	SK6010K SALINCAK ÖN ALT SOL	Ağırlık : 3,13 kg / 6.900 lb Malzeme Türü : Sac Metal	6N040711, 6Q0407151D* 6Q0407151D, 6Q0407151E* 6Q0407151E, 6Q0407151L 6Q0407151Z, 6Q0407365A*
	VW11045 SALINCAK VE DENGE KOLU BURCU ORTA SOL VE SAĞ B40128	Yön : Orta Sol Ve Sağ Ağırlık : 0,145 kg / 0.320 lb	6Q0407182A
	VW11047 SALINCAK VE DENGE KOLU BURCU İÇ SOL VE SAĞ B37117	Yön : İç Sol Ve Sağ Ağırlık : 0,121 kg / 0.267 lb	1K0199231J, 1K0199231J-P 1K0407183E
	VW11051 SALINCAK VE DENGE KOLU BURCU SOL VE SAĞ	Yön : Sol Ve Sağ Ağırlık : 0.121 kg / 0.267 lb	6Q0407183, 6Q0407183A
	VW11055 SALINCAK VE DENGE KOLU BURCU İÇ SOL VE SAĞ	Yön : İç Sol Ve Sağ Ağırlık : 0.121 kg / 0.267 lb	1K0407183E, 8J0407183
	SK11011 TORSİYON BURCU SOL VE SAĞ	Yön : Sol Ve Sağ Ağırlık : 0,346 kg / 0.763 lb	6R0501541A
	VW12066 TORSİYON BURCU SOL VE SAĞ	Yön : Sol Ve Sağ Ağırlık : 0.6 kg / 1.323 lb	1J0 501 541 D, 1J0501541D
	VW12015 VİRAJ DEMİR LASTİĞİ SOL VE SAĞ RUBBER	Şasi (Ön / Arka) : ÖN Yön : Sol Ve Sağ Ağırlık : 0.03 kg / 0.066 lb Malzeme Türü : Rubber Not : VİRAJ DEMİR LASTİĞİ	6Q0411303H, 6Q0411314E 6Q0411314N, 6Q0411314R
	VW12015K VİRAJ DEMİR LASTİĞİ SOL VE SAĞ RUBBER	Şasi (Ön / Arka) : ÖN Yön : Sol Ve Sağ Ağırlık : 0.06 kg / 0.132 lb Malzeme Türü : Rubber Not : VİRAJ LASTİĞİ (İKİLİ)	6Q0411303H*, 6Q0411303H 6Q0411314E*, 6Q0411314E 6Q0411314N*, 6Q0411314N 6Q0411314R*, 6Q0411314R





* Bu sayfada ve katalogdaki tüm araçların adları, markaları, modelleri, sembolleri, logoları, orjinal numaraları (oe) ve diğer üçüncü parti numaraları sadece referans amaçlı kullanılmaktadır.

FABIA
I 6Y2
1999 - 2006

Resim	Ürün Kodu ve Açıklaması	Detay	OEM
	VW12024 VİRAJ DEMİR LASTİĞİ SOL VE SAĞ RUBBER	Şasi (Ön / Arka) : ÖN Yön : Sol Ve Sağ Ağırlık : 0.03 kg / 0.066 lb Malzeme Türü : Rubber Not : VİRAJ LASTİĞİ	6Q0411303AA, 6Q0411303AD 6Q0411305H, 6Q0411314M 6Q0411314Q
	VW12024K VİRAJ DEMİR LASTİĞİ SOL VE SAĞ RUBBER	Şasi (Ön / Arka) : ÖN Yön : Sol Ve Sağ Ağırlık : 0.06 kg / 0.132 lb Malzeme Türü : Rubber Not : VİRAJ LASTİĞİ (İKİLİ)	6Q0411303AA*, 6Q0411303AA 6Q0411303AD*, 6Q0411303AD 6Q0411305H*, 6Q0411305H 6Q0411314M*, 6Q0411314M 6Q0411314Q*, 6Q0411314Q
	VW12049 VİRAJ DEMİR LASTİĞİ SOL VE SAĞ RUBBER	Şasi (Ön / Arka) : ÖN Yön : Sol Ve Sağ Ağırlık : 0.03 kg / 0.066 lb Malzeme Türü : Rubber Not : VİRAJ LASTİĞİ	8Z0411314B
	VW12049K VİRAJ DEMİR LASTİĞİ SOL VE SAĞ RUBBER	Şasi (Ön / Arka) : ÖN Yön : Sol Ve Sağ Ağırlık : 0.06 kg / 0.132 lb Malzeme Türü : Rubber	8Z0411314B*
	VW12062 VİRAJ DEMİR LASTİĞİ SOL VE SAĞ RUBBER	Şasi (Ön / Arka) : ÖN Yön : Sol Ve Sağ Ağırlık : 0.03 kg / 0.066 lb Malzeme Türü : Rubber Not : VİRAJ LASTİĞİ ÖN	6Q0411314F
	VW12062K VİRAJ DEMİR LASTİĞİ SOL VE SAĞ RUBBER	Şasi (Ön / Arka) : ÖN Yön : Sol Ve Sağ Ağırlık : 0.06 kg / 0.132 lb Malzeme Türü : Rubber	6Q0411314F*
	SK12002 AMORTİSÖR TAKOZU ARKA SOL VE SAĞ 1.2 / 1.4TSI / 1.6TDI / 1.2TDI	Şasi (Ön / Arka) : ARKA Yön : Sol Ve Sağ Ağırlık : 0.305 kg / 0.672 lb Not : 1.2 / 1.4TSI / 1.6TDI / 1.2TDI	1J0513353A, 1J0513353B 1J0513353C, 1J0513353G 6QE513353, 6R0513353 6R0513353B
	VW12109 AMORTİSÖR TAKOZU SOL VE SAĞ AMORTİSÖR RULMANI	Yön : Sol Ve Sağ Ağırlık : 0.26 kg / 0.573 lb Not : AMORTİSÖR RULMANI	6N0412249C, 6N0412249E
	VW12109K AMORTİSÖR TAKOZU SOL VE SAĞ 2 PCS	Yön : Sol Ve Sağ Ağırlık : 0.52 kg / 1.146 lb Not : 2 PCS	6N0412249C, 6N0412249E
	VW12115 AMORTİSÖR TAKOZU SOL VE SAĞ AMORTİSÖR TAKOZU	Yön : Sol Ve Sağ Ağırlık : 0.85 kg / 1.874 lb Not : AMORTİSÖR TAKOZU	6N0412331D, 6N0412331E 6Q0412331B
	VW12801 AMORTİSÖR TAKOZU SOL VE SAĞ KIT = VW12115 AND VW12109	Yön : Sol Ve Sağ Ağırlık : 1.269 kg / 2.798 lb Not : KIT = VW12115 and VW12109	6N0412249C, 6N0412249E 6N0412331D, 6N0412331E 6Q0412331B

* Bu sayfada ve katalogdaki tüm araçların adları, markaları, modelleri, sembolleri, logoları, orjinal numaraları (oe) ve diğer üçüncü parti numaraları sadece referans amaçlı kullanılmaktadır.

FABIA
I 6Y2
1999 - 2006

Resim	Ürün Kodu ve Açıklaması	Detay	OEM
	SE12005 MOTOR TAKOZU ARKA	Şasi (Ön / Arka) : ARKA Ağırlık : 1,115 kg / 2.458 lb	6Q0199851AS, 6Q0199851T
	VW12028 MOTOR TAKOZU SOL VE SAĞ MOTOR TAKOZU	Yön : Sol Ve Sağ Ağırlık : 1.1 kg / 2.425 lb Not : MOTOR TAKOZU	6Q0199851, 6Q0199851AK
	VW12069 MOTOR TAKOZU SOL VE SAĞ MOTOR TAKOZU	Yön : Sol Ve Sağ Ağırlık : 0.83 kg / 1.830 lb Not : MOTOR TAKOZU	6Q0199851AB, 6Q0199851AK
	VW12080 MOTOR TAKOZU SOL VE SAĞ MOTOR TAKOZU	Yön : Sol Ve Sağ Ağırlık : 2.02 kg / 4.453 lb Not : MOTOR TAKOZU	6Q0199167AQ, 6Q0199167BM 6Q0199167BQ, 6Q0199167BR 6Q0199167CA, 6Q0199167CB 6Q0199167CC, 6Q0199167CE 6Q0199167CJ, 6Q0199167CR
	VW12083 MOTOR TAKOZU SOL VE SAĞ MOTOR TAKOZU	Yön : Sol Ve Sağ Ağırlık : 1.95 kg / 4.299 lb Not : MOTOR TAKOZU	6Q0199167BC, 6Q0199167BN 6Q0199167CH, 6Q0199167CL 6Q0199167DA, 6Q0199167DB 6Q0199167DL, 6Q0199167DM 6R0199167AA
	VW12093 MOTOR TAKOZU SOL VE SAĞ MOTOR TAKOZU	Yön : Sol Ve Sağ Ağırlık : 1.05 kg / 2.315 lb Not : MOTOR TAKOZU	6Q0199851AC, 6Q0199851AL 6Q0199851AR, 6Q0199851E 6Q0199851S
	VW12123 MOTOR TAKOZU SOL ŞANZUMAN TAKOZU	Yön : Sol Ağırlık : 1.642 kg / 3.620 lb Malzeme Türü : Şanzuman TakoZu	6Q0199555AE, 6Q0199555AT 6R0199555, 6RF199555A 6RF199555C
	VW12036 SÜSPANSİYON TAKOZU SOL VE SAĞ ARKA SUSPANSİYON TAKOZU	Yön : Sol Ve Sağ Ağırlık : 1.591 kg / 3.508 lb Not : ARKA SUSPANSİYON TAKOZU	6Q0512131B
	SK12006 EGZOZ TAKOZU	Ağırlık : 0,185 kg / 0.408 lb	6Q0253144B, 6Q0253144D
	AU14001 AKS KÖRÜĞÜ +KELEPÇE+YAĞ.	Ağırlık : 0.233 kg / 0.514 lb	6Q0498203A
	F114014 AKS KÖRÜĞÜ +KELEPÇE+YAĞ. DIŞ	Ağırlık : 0.211 kg / 0.465 lb	46307841

* Bu sayfada ve katalogdaki tüm araçların adları, markaları, modelleri, sembolleri, logoları, orjinal numaraları (oe) ve diğer üçüncü parti numaraları sadece referans amaçlı kullanılmaktadır.

FABIA
I 6Y2
1999 - 2006

Resim	Ürün Kodu ve Açıklaması	Detay	OEM
	VW14009 AKS KÖRÜĞÜ +KELEPÇE+YAĞ. DIŞ	Ağırlık : 0.16 kg / 0.353 lb	1H0407285B
	AU15001 AMORTİSÖR KÖRÜĞÜ ÖN	Şasi (Ön / Arka) : ÖN Ağırlık : 0,110 kg / 0.243 lb	6N0413175A

FABIA
I COMBI 6Y5
2000 - 2007

Resim	Ürün Kodu ve Açıklaması	Detay	OEM
	SK1023 ROTİL SAĞ RD0530	Ağırlık : 0,46 kg / 1.014 lb Konik Ölçüsü : Ø15 Bağlantı Delik Çapı : Ø8,5 Aşık Diş Çapı : M12X1,5	6Q0407366A, 6Q0407366B 6Q0407366E, 6Q0407366M 8Z0407366A
	SK1023K ROTİL ÖN ALT SAĞ Ø15 KIT	Ağırlık : 0,5 kg / 1.102 lb Konik Ölçüsü : Ø15 Bağlantı Delik Çapı : Ø8,5 Aşık Diş Çapı : M12X1,5	6Q0407366A*, 6Q0407366A 6Q0407366B*, 6Q0407366E* 6Q0407366M*, 6Q0407366M 8Z0407366A*
	SK1024 ROTİL SOL RD0531	Ağırlık : 0,46 kg / 1.014 lb Konik Ölçüsü : Ø15 Bağlantı Delik Çapı : Ø8,5 Aşık Diş Çapı : M12X1,5	6Q0407365A, 6Q0407365B 6Q0407365E, 6Q0407365M 8Z0407365A
	SK1024K ROTİL SOL	Ağırlık : 0,5 kg / 1.102 lb Konik Ölçüsü : Ø15 Bağlantı Delik Çapı : Ø8,5 Aşık Diş Çapı : M12X1,5	6Q0407365A*, 6Q0407365A 6Q0407365B*, 6Q0407365E* 6Q0407365E, 6Q0407365M* 6Q0407365M, 8Z0407365A*
	SK2003 ROTBAŞI SAĞ RC7314	Ağırlık : 0,377 kg / 0.831 lb Uzunluk : 93,5 mm / 3.68 inch Gövde Diş Çapı : M14X1,5 Aşık Diş Çapı : M12X1,5 Aşık Konik Çapı : Ø13,5	5Z0423812, 6Q0419812C 6Q0423812, 6Q0423812A 6Q0423812C, 6Q0423812D 6R0423812, 8Z0423811A
	SK2004 ROTBAŞI SOL RC7313	Ağırlık : 0,382 kg / 0.842 lb Uzunluk : 93 mm / 3.66 inch Gövde Diş Çapı : M14X1,5 Aşık Diş Çapı : M12X1,5 Aşık Konik Çapı : Ø13,5	5Z0423811, 6Q0419811C 6Q0423811, 6Q0423811A 6Q0423811C, 6Q0423811D 6R0423811, 8Z0423812A
	SK3003 ROTMİLİ SAĞ-SOL 297	Ağırlık : 0,552 kg / 1.217 lb Uzunluk : 297 mm / 11.69 inch Gövde Diş Çapı : M14X1,5 Aşık Diş Çapı : M14X1,5	6Q0 423 821 B, 6Q0423821B 6X0422803, 6X0422804 6X0422807, 6X0422821
	SK3004 ROTMİLİ SAĞ-SOL 300 RC7817	Ağırlık : 0,536 kg / 1.182 lb Uzunluk : 300 mm / 11.81 inch Gövde Diş Çapı : M16X1,5 Aşık Diş Çapı : M14X1,5	6Q0423803A, 6Q0423804A 6Q0-423-810-C, 6Q0423821A 6Q0423821C, 6Q0423821G

* Bu sayfada ve katalogdaki tüm araçların adları, markaları, modelleri, sembolleri, logoları, orijinal numaraları (oe) ve diğer üçüncü parti numaraları sadece referans amaçlı kullanılmaktadır.





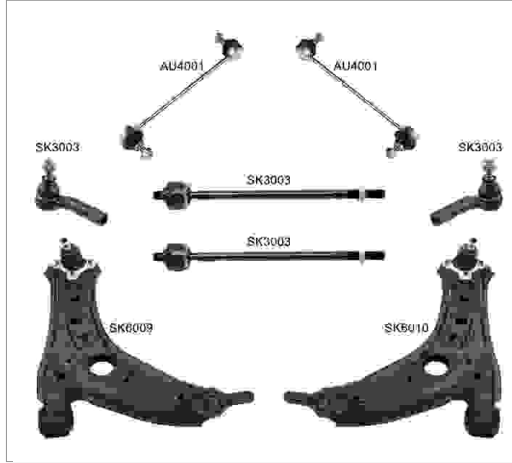





FABIA**I COMBI 6Y5****2000 - 2007**

Resim	Ürün Kodu ve Açıklaması	Detay	OEM
	SK3007 ROTMİLİ SAĞ-SOL	Ağırlık : 0,561 kg / 1.237 lb Uzunluk : 311 mm / 12.24 inch Gövde Diş Çapı : M14X1,5 Aşık Diş Çapı : M14X1,5	6Q0419803B, 6Q0419803D 6Q0419803F, 6Q0419804B 6Q0419804D, 6Q0419804F

SK8001 / Süspansiyon Kit
FABIA
I COMBI 6Y5
2000 - 2007

Kit Parçaları

Resim	Ürün Kodu / Adı	OEM	OEM	Ürün Kodu / Adı	Resim
	AU4001 Z Rot Sol Ve Sağ Metal Rb2911	893407465, 893407465A 8A0407465, 8A0407465B 8A0407465C	5Z0423812, 6Q0419812C 6Q0423812, 6Q0423812A 6Q0423812C, 6Q0423812D 6R0423812, 8Z0423811A	SK2003 Rotbaşı Sağ Rc7314	
	SK2004 Rotbaşı Sol Rc7313	5Z0423811, 6Q0419811C 6Q0423811, 6Q0423811A 6Q0423811C, 6Q0423811D 6R0423811, 8Z0423812A	6Q0 423 821 B, 6Q0423821B 6X0422803, 6X0422804 6X0422807, 6X0422821	SK3003 Rotmili Sağ-sol 297	
	SK6009 Salıncak Ön Alt Sağ Rd1035	6N0407151, 6Q0407151D* 6Q0407151D, 6Q0407151E* 6Q0407151E, 6Q0407151L 6Q0407151Z, 6Q0407366A*	6N040711, 6Q0407151D* 6Q0407151D, 6Q0407151E* 6Q0407151E, 6Q0407151L 6Q0407151Z, 6Q0407365A*	SK6010 Salıncak Ön Alt Sol Rd1036	

FABIA
I COMBI 6Y5
2000 - 2007

Resim	Ürün Kodu ve Açıklaması	Detay	OEM
	SK20033003 ROT TAKIMI ÖN AKS SAĞ RC788115	Ağırlık : 1,021 kg / 2.251 lb Rotbaşı : SK2003 Rotmili : SK3003	6Q0422804B, 6Q0423804B
	SK20033004 ROT TAKIMI ÖN AKS SAĞ RC788117	Ağırlık : 0,915 kg / 2.017 lb Rotbaşı : SK2003 Rotmili : SK3004	6Q0422804G, 6Q0423804A
	SK20033007 ROT TAKIMI ÖN AKS SAĞ	Ağırlık : 0,96 kg / 2.116 lb Rotbaşı : SK2003 Rotmili : SK3007	
	SK20043003 ROT TAKIMI SOL RC788114	Ağırlık : 0,932 kg / 2.055 lb Rotbaşı : SK2004 Rotmili : SK3003	6Q0422803B, 6Q0423803B
	SK20043004 ROT TAKIMI ÖN AKS SOL RC788116	Ağırlık : 0,903 kg / 1.991 lb Rotbaşı : SK2004 Rotmili : SK3004	6Q0422803G, 6Q0423803A
	SK20043007 ROT TAKIMI ÖN AKS SOL	Ağırlık : 0,96 kg / 2.116 lb Rotbaşı : SK2004 Rotmili : SK3007	
	AU4001 Z ROT SOL VE SAĞ METAL RB2911	Ağırlık : 0,357 kg / 0.787 lb Malzeme Türü : Metal Uzunluk : 270 mm / 10.63 inch Aşık Diş Çapı : M10X1,5	893407465, 893407465A 8A0407465, 8A0407465B 8A0407465C
	AU4001A Z ROT ÖN PLASTİK	Ağırlık : 0,295 kg / 0.650 lb Malzeme Türü : Plastik Uzunluk : 317 mm / 12.48 inch	893407465, 893407465A 8A0407465, 8A0407465B 8A0407465C
	AU4028 Z ROT ÖN	Ağırlık : 0,368 kg / 0.811 lb Malzeme Türü : Metal Uzunluk : 270 mm / 10.63 inch Aşık Diş Çapı : M10X1,5	6Q0411315L, 6Q0411315N 8Z0411315D
	SK6009 SALINCAK ÖN ALT SAĞ RD1035	Ağırlık : 2,676 kg / 5.900 lb Malzeme Türü : Sac Metal	6N0407151, 6Q0407151D* 6Q0407151D, 6Q0407151E* 6Q0407151E, 6Q0407151L 6Q0407151Z, 6Q0407366A*
	SK6009J SALINCAK ÖN ALT RD10211	Ağırlık : 2,626 kg / 5.789 lb Malzeme Türü : Sac Metal	6Q0407151D, 6Q0407151E 6Q0407151L

* Bu sayfada ve katalogdaki tüm araçların adları, markaları, modelleri, sembolleri, logoları, orijinal numaraları (oe) ve diğer üçüncü parti numaraları sadece referans amaçlı kullanılmaktadır.

FABIA
I COMBI 6Y5
2000 - 2007

Resim	Ürün Kodu ve Açıklaması	Detay	OEM
	SK6009K SALINCAK ÖN ALT SAĞ	Ağırlık : 3,13 kg / 6.900 lb Malzeme Türü : Sac Metal	6N0407151, 6Q0407151D 6Q0407151E, 6Q0407151L 6Q0407151Z
	SK6010 SALINCAK ÖN ALT SOL RD1036	Ağırlık : 3,13 kg / 6.900 lb Malzeme Türü : Sac Metal	6N040711, 6Q0407151D* 6Q0407151D, 6Q0407151E* 6Q0407151E, 6Q0407151L 6Q0407151Z, 6Q0407365A*
	SK6010K SALINCAK ÖN ALT SOL	Ağırlık : 3,13 kg / 6.900 lb Malzeme Türü : Sac Metal	6N040711, 6Q0407151D* 6Q0407151D, 6Q0407151E* 6Q0407151E, 6Q0407151L 6Q0407151Z, 6Q0407365A*
	VW11045 SALINCAK VE DENGE KOLU BURCU ORTA SOL VE SAĞ B40128	Yön : Orta Sol Ve Sağ Ağırlık : 0,145 kg / 0.320 lb	6Q0407182A
	VW11047 SALINCAK VE DENGE KOLU BURCU İÇ SOL VE SAĞ B37117	Yön : İç Sol Ve Sağ Ağırlık : 0,121 kg / 0.267 lb	1K0199231J, 1K0199231J-P 1K0407183E
	VW11051 SALINCAK VE DENGE KOLU BURCU SOL VE SAĞ	Yön : Sol Ve Sağ Ağırlık : 0.121 kg / 0.267 lb	6Q0407183, 6Q0407183A
	VW11055 SALINCAK VE DENGE KOLU BURCU İÇ SOL VE SAĞ	Yön : İç Sol Ve Sağ Ağırlık : 0.121 kg / 0.267 lb	1K0407183E, 8J0407183
	SK11011 TORSİYON BURCU SOL VE SAĞ	Yön : Sol Ve Sağ Ağırlık : 0,346 kg / 0.763 lb	6R0501541A
	VW12066 TORSİYON BURCU SOL VE SAĞ	Yön : Sol Ve Sağ Ağırlık : 0.6 kg / 1.323 lb	1J0 501 541 D, 1J0501541D
	VW12015 VİRAJ DEMİR LASTİĞİ SOL VE SAĞ RUBBER	Şasi (Ön / Arka) : ÖN Yön : Sol Ve Sağ Ağırlık : 0.03 kg / 0.066 lb Malzeme Türü : Rubber Not : VİRAJ DEMİR LASTİĞİ	6Q0411303H, 6Q0411314E 6Q0411314N, 6Q0411314R
	VW12015K VİRAJ DEMİR LASTİĞİ SOL VE SAĞ RUBBER	Şasi (Ön / Arka) : ÖN Yön : Sol Ve Sağ Ağırlık : 0.06 kg / 0.132 lb Malzeme Türü : Rubber Not : VİRAJ LASTİĞİ (İKİLİ)	6Q0411303H*, 6Q0411303H 6Q0411314E*, 6Q0411314E 6Q0411314N*, 6Q0411314N 6Q0411314R*, 6Q0411314R

* Bu sayfada ve katalogdaki tüm araçların adları, markaları, modelleri, sembolleri, logoları, orjinal numaraları (oe) ve diğer üçüncü parti numaraları sadece referans amaçlı kullanılmaktadır.

FABIA
I COMBI 6Y5
2000 - 2007

Resim	Ürün Kodu ve Açıklaması	Detay	OEM
	VW12024 VİRAJ DEMİR LASTİĞİ SOL VE SAĞ RUBBER	Şasi (Ön / Arka) : ÖN Yön : Sol Ve Sağ Ağırlık : 0.03 kg / 0.066 lb Malzeme Türü : Rubber Not : VİRAJ LASTİĞİ	6Q0411303AA, 6Q0411303AD 6Q0411305H, 6Q0411314M 6Q0411314Q
	VW12024K VİRAJ DEMİR LASTİĞİ SOL VE SAĞ RUBBER	Şasi (Ön / Arka) : ÖN Yön : Sol Ve Sağ Ağırlık : 0.06 kg / 0.132 lb Malzeme Türü : Rubber Not : VİRAJ LASTİĞİ (İKİLİ)	6Q0411303AA*, 6Q0411303AA 6Q0411303AD*, 6Q0411303AD 6Q0411305H*, 6Q0411305H 6Q0411314M*, 6Q0411314M 6Q0411314Q*, 6Q0411314Q
	VW12049 VİRAJ DEMİR LASTİĞİ SOL VE SAĞ RUBBER	Şasi (Ön / Arka) : ÖN Yön : Sol Ve Sağ Ağırlık : 0.03 kg / 0.066 lb Malzeme Türü : Rubber Not : VİRAJ LASTİĞİ	8Z0411314B
	VW12049K VİRAJ DEMİR LASTİĞİ SOL VE SAĞ RUBBER	Şasi (Ön / Arka) : ÖN Yön : Sol Ve Sağ Ağırlık : 0.06 kg / 0.132 lb Malzeme Türü : Rubber	8Z0411314B*
	VW12062 VİRAJ DEMİR LASTİĞİ SOL VE SAĞ RUBBER	Şasi (Ön / Arka) : ÖN Yön : Sol Ve Sağ Ağırlık : 0.03 kg / 0.066 lb Malzeme Türü : Rubber Not : VİRAJ LASTİĞİ ÖN	6Q0411314F
	VW12062K VİRAJ DEMİR LASTİĞİ SOL VE SAĞ RUBBER	Şasi (Ön / Arka) : ÖN Yön : Sol Ve Sağ Ağırlık : 0.06 kg / 0.132 lb Malzeme Türü : Rubber	6Q0411314F*
	SK12002 AMORTİSÖR TAKOZU ARKA SOL VE SAĞ 1.2 / 1.4TSI / 1.6TDI / 1.2TDI	Şasi (Ön / Arka) : ARKA Yön : Sol Ve Sağ Ağırlık : 0.305 kg / 0.672 lb Not : 1.2 / 1.4TSI / 1.6TDI / 1.2TDI	1J0513353A, 1J0513353B 1J0513353C, 1J0513353G 6QE513353, 6R0513353 6R0513353B
	VW12109 AMORTİSÖR TAKOZU SOL VE SAĞ AMORTİSÖR RULMANI	Yön : Sol Ve Sağ Ağırlık : 0.26 kg / 0.573 lb Not : AMORTİSÖR RULMANI	6N0412249C, 6N0412249E
	VW12109K AMORTİSÖR TAKOZU SOL VE SAĞ 2 PCS	Yön : Sol Ve Sağ Ağırlık : 0.52 kg / 1.146 lb Not : 2 PCS	6N0412249C, 6N0412249E
	VW12115 AMORTİSÖR TAKOZU SOL VE SAĞ AMORTİSÖR TAKOZU	Yön : Sol Ve Sağ Ağırlık : 0.85 kg / 1.874 lb Not : AMORTİSÖR TAKOZU	6N0412331D, 6N0412331E 6Q0412331B
	VW12801 AMORTİSÖR TAKOZU SOL VE SAĞ KIT = VW12115 AND VW12109	Yön : Sol Ve Sağ Ağırlık : 1.269 kg / 2.798 lb Not : KIT = VW12115 and VW12109	6N0412249C, 6N0412249E 6N0412331D, 6N0412331E 6Q0412331B

* Bu sayfada ve katalogdaki tüm araçların adları, markaları, modelleri, sembolleri, logoları, orjinal numaraları (oe) ve diğer üçüncü parti numaraları sadece referans amaçlı kullanılmaktadır.

FABIA
I COMBI 6Y5
2000 - 2007









Resim	Ürün Kodu ve Açıklaması	Detay	OEM
	SE12005 MOTOR TAKOZU ARKA	Şasi (Ön / Arka) : ARKA Ağırlık : 1,115 kg / 2.458 lb	6Q0199851AS, 6Q0199851T
	VW12028 MOTOR TAKOZU SOL VE SAĞ MOTOR TAKOZU	Yön : Sol Ve Sağ Ağırlık : 1.1 kg / 2.425 lb Not : MOTOR TAKOZU	6Q0199851, 6Q0199851AK
	VW12069 MOTOR TAKOZU SOL VE SAĞ MOTOR TAKOZU	Yön : Sol Ve Sağ Ağırlık : 0.83 kg / 1.830 lb Not : MOTOR TAKOZU	6Q0199851AB, 6Q0199851AK
	VW12080 MOTOR TAKOZU SOL VE SAĞ MOTOR TAKOZU	Yön : Sol Ve Sağ Ağırlık : 2.02 kg / 4.453 lb Not : MOTOR TAKOZU	6Q0199167AQ, 6Q0199167BM 6Q0199167BQ, 6Q0199167BR 6Q0199167CA, 6Q0199167CB 6Q0199167CC, 6Q0199167CE 6Q0199167CJ, 6Q0199167CR
	VW12083 MOTOR TAKOZU SOL VE SAĞ MOTOR TAKOZU	Yön : Sol Ve Sağ Ağırlık : 1.95 kg / 4.299 lb Not : MOTOR TAKOZU	6Q0199167BC, 6Q0199167BN 6Q0199167CH, 6Q0199167CL 6Q0199167DA, 6Q0199167DB 6Q0199167DL, 6Q0199167DM 6R0199167AA
	VW12093 MOTOR TAKOZU SOL VE SAĞ MOTOR TAKOZU	Yön : Sol Ve Sağ Ağırlık : 1.05 kg / 2.315 lb Not : MOTOR TAKOZU	6Q0199851AC, 6Q0199851AL 6Q0199851AR, 6Q0199851E 6Q0199851S
	VW12123 MOTOR TAKOZU SOL ŞANZUMAN TAKOZU	Yön : Sol Ağırlık : 1.642 kg / 3.620 lb Malzeme Türü : Şanzuman Takozu	6Q0199555AE, 6Q0199555AT 6R0199555, 6RF199555A 6RF199555C
	VW12036 SÜSPANSİYON TAKOZU SOL VE SAĞ ARKA SUSPANSİYON TAKOZU	Yön : Sol Ve Sağ Ağırlık : 1.591 kg / 3.508 lb Not : ARKA SUSPANSİYON TAKOZU	6Q0512131B
	AU14001 AKS KÖRÜĞÜ +KELEPÇE+YAĞ.	Ağırlık : 0.233 kg / 0.514 lb	6Q0498203A
	F114014 AKS KÖRÜĞÜ +KELEPÇE+YAĞ. DIŞ	Ağırlık : 0.211 kg / 0.465 lb	46307841
	VW14009 AKS KÖRÜĞÜ +KELEPÇE+YAĞ. DIŞ	Ağırlık : 0.16 kg / 0.353 lb	1H0407285B

* Bu sayfada ve katalogdaki tüm araçların adları, markaları, modelleri, sembolleri, logoları, orjinal numaraları (oe) ve diğer üçüncü parti numaraları sadece referans amaçlı kullanılmaktadır.

FABIA I COMBI 6Y5 2000 - 2007

Resim	Ürün Kodu ve Açıklaması	Detay	OEM
	AU15001 AMORTİSÖR KÖRÜĞÜ ÖN	Şasi (Ön / Arka) : ÖN Ağırlık : 0,110 kg / 0.243 lb	6N0413175A

FABIA I PRAKTIK 6Y5 2001 - 2007

Resim	Ürün Kodu ve Açıklaması	Detay	OEM
	SK1023 ROTİL SAĞ RD0530	Ağırlık : 0,46 kg / 1.014 lb Konik Ölçüsü : Ø15 Bağlantı Delik Çapı : Ø8,5 Aşık Dış Çapı : M12X1,5	6Q0407366A, 6Q0407366B 6Q0407366E, 6Q0407366M 8Z0407366A
	SK1023K ROTİL ÖN ALT SAĞ Ø15 KIT	Ağırlık : 0,5 kg / 1.102 lb Konik Ölçüsü : Ø15 Bağlantı Delik Çapı : Ø8,5 Aşık Dış Çapı : M12X1,5	6Q0407366A*, 6Q0407366A 6Q0407366B*, 6Q0407366E* 6Q0407366M*, 6Q0407366M 8Z0407366A*
	SK1024 ROTİL SOL RD0531	Ağırlık : 0,46 kg / 1.014 lb Konik Ölçüsü : Ø15 Bağlantı Delik Çapı : Ø8,5 Aşık Dış Çapı : M12X1,5	6Q0407365A, 6Q0407365B 6Q0407365E, 6Q0407365M 8Z0407365A
	SK1024K ROTİL SOL	Ağırlık : 0,5 kg / 1.102 lb Konik Ölçüsü : Ø15 Bağlantı Delik Çapı : Ø8,5 Aşık Dış Çapı : M12X1,5	6Q0407365A*, 6Q0407365A 6Q0407365B*, 6Q0407365E* 6Q0407365E, 6Q0407365M* 6Q0407365M, 8Z0407365A*
	SK2003 ROTBAŞI SAĞ RC7314	Ağırlık : 0,377 kg / 0.831 lb Uzunluk : 93,5 mm / 3.68 inch Gövde Dış Çapı : M14X1,5 Aşık Dış Çapı : M12X1,5 Aşık Konik Çapı : Ø13,5	5Z0423812, 6Q0419812C 6Q0423812, 6Q0423812A 6Q0423812C, 6Q0423812D 6R0423812, 8Z0423811A
	SK2004 ROTBAŞI SOL RC7313	Ağırlık : 0,382 kg / 0.842 lb Uzunluk : 93 mm / 3.66 inch Gövde Dış Çapı : M14X1,5 Aşık Dış Çapı : M12X1,5 Aşık Konik Çapı : Ø13,5	5Z0423811, 6Q0419811C 6Q0423811, 6Q0423811A 6Q0423811C, 6Q0423811D 6R0423811, 8Z0423812A
	SK3003 ROTMİLİ SAĞ-SOL 297	Ağırlık : 0,552 kg / 1.217 lb Uzunluk : 297 mm / 11.69 inch Gövde Dış Çapı : M14X1,5 Aşık Dış Çapı : M14X1,5	6Q0 423 821 B, 6Q0423821B 6X0422803, 6X0422804 6X0422807, 6X0422821
	SK3004 ROTMİLİ SAĞ-SOL 300 RC7817	Ağırlık : 0,536 kg / 1.182 lb Uzunluk : 300 mm / 11.81 inch Gövde Dış Çapı : M16X1,5 Aşık Dış Çapı : M14X1,5	6Q0423803A, 6Q0423804A 6Q0-423-810-C, 6Q0423821A 6Q0423821C, 6Q0423821G
	SK3007 ROTMİLİ SAĞ-SOL	Ağırlık : 0,561 kg / 1.237 lb Uzunluk : 311 mm / 12.24 inch Gövde Dış Çapı : M14X1,5 Aşık Dış Çapı : M14X1,5	6Q0419803B, 6Q0419803D 6Q0419803F, 6Q0419804B 6Q0419804D, 6Q0419804F

* Bu sayfada ve katalogdaki tüm araçların adları, markaları, modelleri, sembolleri, logoları, orijinal numaraları (oe) ve diğer üçüncü parti numaraları sadece referans amaçlı kullanılmaktadır.

SK8001 / Süspansiyon Kit

FABIA

I PRAKTIK 6Y5



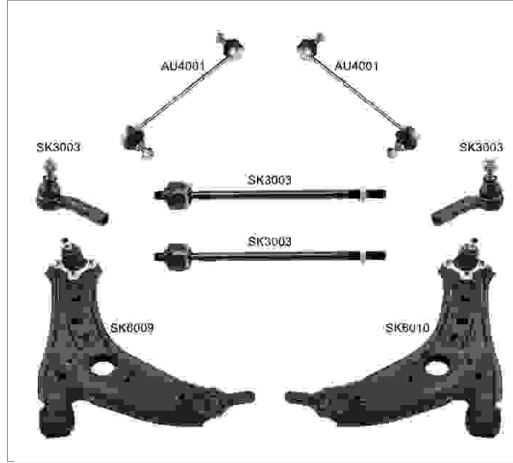







2001 - 2007



Kit Parçaları

Resim	Ürün Kodu / Adı	OEM	OEM	Ürün Kodu / Adı	Resim
	AU4001 Z Rot Sol Ve Sağ Metal Rb2911	893407465, 893407465A 8A0407465, 8A0407465B 8A0407465C	5Z0423812, 6Q0419812C 6Q0423812, 6Q0423812A 6Q0423812C, 6Q0423812D 6R0423812, 8Z0423811A	SK2003 Rotbaşı Sağ Rc7314	
	SK2004 Rotbaşı Sol Rc7313	5Z0423811, 6Q0419811C 6Q0423811, 6Q0423811A 6Q0423811C, 6Q0423811D 6R0423811, 8Z0423812A	6Q0 423 821 B, 6Q0423821B 6X0422803, 6X0422804 6X0422807, 6X0422821	SK3003 Rotmili Sağ-sol 297	
	SK6009 Salıncak Ön Alt Sağ Rd1035	6N0407151, 6Q0407151D* 6Q0407151D, 6Q0407151E* 6Q0407151E, 6Q0407151L 6Q0407151Z, 6Q0407366A*	6N040711, 6Q0407151D* 6Q0407151D, 6Q0407151E* 6Q0407151E, 6Q0407151L 6Q0407151Z, 6Q0407365A*	SK6010 Salıncak Ön Alt Sol Rd1036	

FABIA
I PRAKTİK 6Y5
2001 - 2007

Resim	Ürün Kodu ve Açıklaması	Detay	OEM
	SK20033003 ROT TAKIMI ÖN AKS SAĞ RC788115	Ağırlık : 1,021 kg / 2.251 lb Rotbaşı : SK2003 Rotmili : SK3003	6Q0422804B, 6Q0423804B
	SK20033004 ROT TAKIMI ÖN AKS SAĞ RC788117	Ağırlık : 0,915 kg / 2.017 lb Rotbaşı : SK2003 Rotmili : SK3004	6Q0422804G, 6Q0423804A
	SK20033007 ROT TAKIMI ÖN AKS SAĞ	Ağırlık : 0,96 kg / 2.116 lb Rotbaşı : SK2003 Rotmili : SK3007	
	SK20043003 ROT TAKIMI SOL RC788114	Ağırlık : 0,932 kg / 2.055 lb Rotbaşı : SK2004 Rotmili : SK3003	6Q0422803B, 6Q0423803B
	SK20043004 ROT TAKIMI ÖN AKS SOL RC788116	Ağırlık : 0,903 kg / 1.991 lb Rotbaşı : SK2004 Rotmili : SK3004	6Q0422803G, 6Q0423803A
	SK20043007 ROT TAKIMI ÖN AKS SOL	Ağırlık : 0,96 kg / 2.116 lb Rotbaşı : SK2004 Rotmili : SK3007	
	AU4001 Z ROT SOL VE SAĞ METAL RB2911	Ağırlık : 0,357 kg / 0.787 lb Malzeme Türü : Metal Uzunluk : 270 mm / 10.63 inch Aşık Diş Çapı : M10X1,5	893407465, 893407465A 8A0407465, 8A0407465B 8A0407465C
	AU4001A Z ROT ÖN PLASTİK	Ağırlık : 0,295 kg / 0.650 lb Malzeme Türü : Plastik Uzunluk : 317 mm / 12.48 inch	893407465, 893407465A 8A0407465, 8A0407465B 8A0407465C
	AU4028 Z ROT ÖN	Ağırlık : 0,368 kg / 0.811 lb Malzeme Türü : Metal Uzunluk : 270 mm / 10.63 inch Aşık Diş Çapı : M10X1,5	6Q0411315L, 6Q0411315N 8Z0411315D
	SK6009 SALINCAK ÖN ALT SAĞ RD1035	Ağırlık : 2,676 kg / 5.900 lb Malzeme Türü : Sac Metal	6N0407151, 6Q0407151D* 6Q0407151D, 6Q0407151E* 6Q0407151E, 6Q0407151L 6Q0407151Z, 6Q0407366A*
	SK6009J SALINCAK ÖN ALT RD10211	Ağırlık : 2,626 kg / 5.789 lb Malzeme Türü : Sac Metal	6Q0407151D, 6Q0407151E 6Q0407151L

* Bu sayfada ve katalogdaki tüm araçların adları, markaları, modelleri, sembolleri, logoları, orijinal numaraları (oe) ve diğer üçüncü parti numaraları sadece referans amaçlı kullanılmaktadır.

FABIA
I PRAKTİK 6Y5
2001 - 2007

Resim	Ürün Kodu ve Açıklaması	Detay	OEM
	SK6009K SALINCAK ÖN ALT SAĞ	Ağırlık : 3,13 kg / 6.900 lb Malzeme Türü : Sac Metal	6N0407151, 6Q0407151D 6Q0407151E, 6Q0407151L 6Q0407151Z
	SK6010 SALINCAK ÖN ALT SOL RD1036	Ağırlık : 3,13 kg / 6.900 lb Malzeme Türü : Sac Metal	6N040711, 6Q0407151D* 6Q0407151D, 6Q0407151E* 6Q0407151E, 6Q0407151L 6Q0407151Z, 6Q0407365A*
	SK6010K SALINCAK ÖN ALT SOL	Ağırlık : 3,13 kg / 6.900 lb Malzeme Türü : Sac Metal	6N040711, 6Q0407151D* 6Q0407151D, 6Q0407151E* 6Q0407151E, 6Q0407151L 6Q0407151Z, 6Q0407365A*
	VW11045 SALINCAK VE DENGE KOLU BURCU ORTA SOL VE SAĞ B40128	Yön : Orta Sol Ve Sağ Ağırlık : 0,145 kg / 0.320 lb	6Q0407182A
	VW11047 SALINCAK VE DENGE KOLU BURCU İÇ SOL VE SAĞ B37117	Yön : İç Sol Ve Sağ Ağırlık : 0,121 kg / 0.267 lb	1K0199231J, 1K0199231J-P 1K0407183E
	VW11051 SALINCAK VE DENGE KOLU BURCU SOL VE SAĞ	Yön : Sol Ve Sağ Ağırlık : 0.121 kg / 0.267 lb	6Q0407183, 6Q0407183A
	VW11055 SALINCAK VE DENGE KOLU BURCU İÇ SOL VE SAĞ	Yön : İç Sol Ve Sağ Ağırlık : 0.121 kg / 0.267 lb	1K0407183E, 8J0407183
	SK11011 TORSİYON BURCU SOL VE SAĞ	Yön : Sol Ve Sağ Ağırlık : 0,346 kg / 0.763 lb	6R0501541A
	VW12066 TORSİYON BURCU SOL VE SAĞ	Yön : Sol Ve Sağ Ağırlık : 0.6 kg / 1.323 lb	1J0 501 541 D, 1J0501541D
	VW12015 VİRAJ DEMİR LASTİĞİ SOL VE SAĞ RUBBER	Şasi (Ön / Arka) : ÖN Yön : Sol Ve Sağ Ağırlık : 0.03 kg / 0.066 lb Malzeme Türü : Rubber Not : VİRAJ DEMİR LASTİĞİ	6Q0411303H, 6Q0411314E 6Q0411314N, 6Q0411314R
	VW12015K VİRAJ DEMİR LASTİĞİ SOL VE SAĞ RUBBER	Şasi (Ön / Arka) : ÖN Yön : Sol Ve Sağ Ağırlık : 0.06 kg / 0.132 lb Malzeme Türü : Rubber Not : VİRAJ LASTİĞİ (İKİLİ)	6Q0411303H*, 6Q0411303H 6Q0411314E*, 6Q0411314E 6Q0411314N*, 6Q0411314N 6Q0411314R*, 6Q0411314R





* Bu sayfada ve katalogdaki tüm araçların adları, markaları, modelleri, sembolleri, logoları, orjinal numaraları (oe) ve diğer üçüncü parti numaraları sadece referans amaçlı kullanılmaktadır.

FABIA
I PRAKTİK 6Y5
2001 - 2007







Resim	Ürün Kodu ve Açıklaması	Detay	OEM
	VW12024 VİRAJ DEMİR LASTİĞİ SOL VE SAĞ RUBBER	Şasi (Ön / Arka) : ÖN Yön : Sol Ve Sağ Ağırlık : 0.03 kg / 0.066 lb Malzeme Türü : Rubber Not : VİRAJ LASTİĞİ	6Q0411303AA, 6Q0411303AD 6Q0411305H, 6Q0411314M 6Q0411314Q
	VW12024K VİRAJ DEMİR LASTİĞİ SOL VE SAĞ RUBBER	Şasi (Ön / Arka) : ÖN Yön : Sol Ve Sağ Ağırlık : 0.06 kg / 0.132 lb Malzeme Türü : Rubber Not : VİRAJ LASTİĞİ (İKİLİ)	6Q0411303AA*, 6Q0411303AA 6Q0411303AD*, 6Q0411303AD 6Q0411305H*, 6Q0411305H 6Q0411314M*, 6Q0411314M 6Q0411314Q*, 6Q0411314Q
	VW12049 VİRAJ DEMİR LASTİĞİ SOL VE SAĞ RUBBER	Şasi (Ön / Arka) : ÖN Yön : Sol Ve Sağ Ağırlık : 0.03 kg / 0.066 lb Malzeme Türü : Rubber Not : VİRAJ LASTİĞİ	8Z0411314B
	VW12049K VİRAJ DEMİR LASTİĞİ SOL VE SAĞ RUBBER	Şasi (Ön / Arka) : ÖN Yön : Sol Ve Sağ Ağırlık : 0.06 kg / 0.132 lb Malzeme Türü : Rubber	8Z0411314B*
	VW12062 VİRAJ DEMİR LASTİĞİ SOL VE SAĞ RUBBER	Şasi (Ön / Arka) : ÖN Yön : Sol Ve Sağ Ağırlık : 0.03 kg / 0.066 lb Malzeme Türü : Rubber Not : VİRAJ LASTİĞİ ÖN	6Q0411314F
	VW12062K VİRAJ DEMİR LASTİĞİ SOL VE SAĞ RUBBER	Şasi (Ön / Arka) : ÖN Yön : Sol Ve Sağ Ağırlık : 0.06 kg / 0.132 lb Malzeme Türü : Rubber	6Q0411314F*
	VW12109 AMORTİSÖR TAKOZU SOL VE SAĞ AMORTİSÖR RULMANI	Yön : Sol Ve Sağ Ağırlık : 0.26 kg / 0.573 lb Not : AMORTİSÖR RULMANI	6N0412249C, 6N0412249E
	VW12109K AMORTİSÖR TAKOZU SOL VE SAĞ 2 PCS	Yön : Sol Ve Sağ Ağırlık : 0.52 kg / 1.146 lb Not : 2 PCS	6N0412249C, 6N0412249E
	VW12115 AMORTİSÖR TAKOZU SOL VE SAĞ AMORTİSÖR TAKOZU	Yön : Sol Ve Sağ Ağırlık : 0.85 kg / 1.874 lb Not : AMORTİSÖR TAKOZU	6N0412331D, 6N0412331E 6Q0412331B
	VW12801 AMORTİSÖR TAKOZU SOL VE SAĞ KIT = VW12115 AND VW12109	Yön : Sol Ve Sağ Ağırlık : 1.269 kg / 2.798 lb Not : KIT = VW12115 and VW12109	6N0412249C, 6N0412249E 6N0412331D, 6N0412331E 6Q0412331B
	SE12005 MOTOR TAKOZU ARKA	Şasi (Ön / Arka) : ARKA Ağırlık : 1,115 kg / 2.458 lb	6Q0199851AS, 6Q0199851T

* Bu sayfada ve katalogdaki tüm araçların adları, markaları, modelleri, sembolleri, logoları, orjinal numaraları (oe) ve diğer üçüncü parti numaraları sadece referans amaçlı kullanılmaktadır.

FABIA
I PRAKTİK 6Y5
2001 - 2007

Resim	Ürün Kodu ve Açıklaması	Detay	OEM
	VW12036 SÜSPANSİYON TAKOZU SOL VE SAĞ ARKA SUSPANSİYON TAKOZU	Yön : Sol Ve Sağ Ağırlık : 1.591 kg / 3.508 lb Not : ARKA SUSPANSİYON TAKOZU	6Q0512131B
	SK12006 EGZOZ TAKOZU	Ağırlık : 0,185 kg / 0.408 lb	6Q0253144B, 6Q0253144D
	AU14001 AKS KÖRÜĞÜ +KELEPÇE+YAĞ.	Ağırlık : 0.233 kg / 0.514 lb	6Q0498203A
	F114014 AKS KÖRÜĞÜ +KELEPÇE+YAĞ. DIŞ	Ağırlık : 0.211 kg / 0.465 lb	46307841

FABIA
I SALOON 6Y3
1999 - 2006





Resim	Ürün Kodu ve Açıklaması	Detay	OEM
	SK1023 ROTİL SAĞ RD0530	Ağırlık : 0,46 kg / 1.014 lb Konik Ölçüsü : Ø15 Bağlantı Delik Çapı : Ø8,5 Aşık Diş Çapı : M12X1,5	6Q0407366A, 6Q0407366B 6Q0407366E, 6Q0407366M 8Z0407366A
	SK1023K ROTİL ÖN ALT SAĞ Ø15 KIT	Ağırlık : 0,5 kg / 1.102 lb Konik Ölçüsü : Ø15 Bağlantı Delik Çapı : Ø8,5 Aşık Diş Çapı : M12X1,5	6Q0407366A*, 6Q0407366A 6Q0407366B*, 6Q0407366E* 6Q0407366M*, 6Q0407366M 8Z0407366A*
	SK1024 ROTİL SOL RD0531	Ağırlık : 0,46 kg / 1.014 lb Konik Ölçüsü : Ø15 Bağlantı Delik Çapı : Ø8,5 Aşık Diş Çapı : M12X1,5	6Q0407365A, 6Q0407365B 6Q0407365E, 6Q0407365M 8Z0407365A
	SK1024K ROTİL SOL	Ağırlık : 0,5 kg / 1.102 lb Konik Ölçüsü : Ø15 Bağlantı Delik Çapı : Ø8,5 Aşık Diş Çapı : M12X1,5	6Q0407365A*, 6Q0407365A 6Q0407365B*, 6Q0407365E* 6Q0407365E, 6Q0407365M* 6Q0407365M, 8Z0407365A*
	SK2003 ROTBAŞI SAĞ RC7314	Ağırlık : 0,377 kg / 0.831 lb Uzunluk : 93,5 mm / 3.68 inch Gövde Diş Çapı : M14X1,5 Aşık Diş Çapı : M12X1,5 Aşık Konik Çapı : Ø13,5	5Z0423812, 6Q0419812C 6Q0423812, 6Q0423812A 6Q0423812C, 6Q0423812D 6R0423812, 8Z0423811A
	SK2004 ROTBAŞI SOL RC7313	Ağırlık : 0,382 kg / 0.842 lb Uzunluk : 93 mm / 3.66 inch Gövde Diş Çapı : M14X1,5 Aşık Diş Çapı : M12X1,5 Aşık Konik Çapı : Ø13,5	5Z0423811, 6Q0419811C 6Q0423811, 6Q0423811A 6Q0423811C, 6Q0423811D 6R0423811, 8Z0423812A

* Bu sayfada ve katalogdaki tüm araçların adları, markaları, modelleri, sembolleri, logoları, orjinal numaraları (oe) ve diğer üçüncü parti numaraları sadece referans amaçlı kullanılmaktadır.

FABIA

I SALOON 6Y3





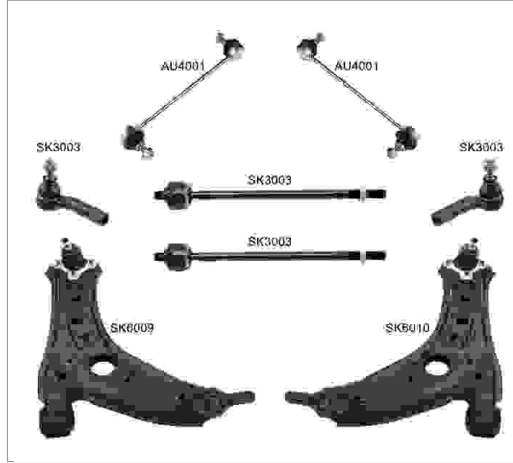





1999 - 2006

Resim	Ürün Kodu ve Açıklaması	Detay	OEM
	SK3003 ROTMİLİ SAĞ-SOL 297	Ağırlık : 0,552 kg / 1.217 lb Uzunluk : 297 mm / 11.69 inch Gövde Diş Çapı : M14X1,5 Aşık Diş Çapı : M14X1,5	6Q0 423 821 B, 6Q0423821B 6X0422803, 6X0422804 6X0422807, 6X0422821
	SK3004 ROTMİLİ SAĞ-SOL 300 RC7817	Ağırlık : 0,536 kg / 1.182 lb Uzunluk : 300 mm / 11.81 inch Gövde Diş Çapı : M16X1,5 Aşık Diş Çapı : M14X1,5	6Q0423803A, 6Q0423804A 6Q0-423-810-C, 6Q0423821A 6Q0423821C, 6Q0423821G
	SK3007 ROTMİLİ SAĞ-SOL	Ağırlık : 0,561 kg / 1.237 lb Uzunluk : 311 mm / 12.24 inch Gövde Diş Çapı : M14X1,5 Aşık Diş Çapı : M14X1,5	6Q0419803B, 6Q0419803D 6Q0419803F, 6Q0419804B 6Q0419804D, 6Q0419804F
	VW3018 ROTMİLİ ÖN SAĞ-SOL	Ağırlık : 0,552 kg / 1.217 lb Uzunluk : 297 mm / 11.69 inch Gövde Diş Çapı : M14X1,5 Aşık Diş Çapı : M14X1,5	6X0422803, 6X0422804 6X0422807, 6X0422821

SK8001 / Süspansiyon Kit
FABIA
I SALOON 6Y3
1999 - 2006

Kit Parçaları

Resim	Ürün Kodu / Adı	OEM	OEM	Ürün Kodu / Adı	Resim
	AU4001 Z Rot Sol Ve Sağ Metal Rb2911	893407465, 893407465A 8A0407465, 8A0407465B 8A0407465C	5Z0423812, 6Q0419812C 6Q0423812, 6Q0423812A 6Q0423812C, 6Q0423812D 6R0423812, 8Z0423811A	SK2003 Rotbaşı Sağ Rc7314	
	SK2004 Rotbaşı Sol Rc7313	5Z0423811, 6Q0419811C 6Q0423811, 6Q0423811A 6Q0423811C, 6Q0423811D 6R0423811, 8Z0423812A	6Q0 423 821 B, 6Q0423821B 6X0422803, 6X0422804 6X0422807, 6X0422821	SK3003 Rotmili Sağ-sol 297	
	SK6009 Salıncak Ön Alt Sağ Rd1035	6N0407151, 6Q0407151D* 6Q0407151D, 6Q0407151E* 6Q0407151E, 6Q0407151L 6Q0407151Z, 6Q0407366A*	6N040711, 6Q0407151D* 6Q0407151D, 6Q0407151E* 6Q0407151E, 6Q0407151L 6Q0407151Z, 6Q0407365A*	SK6010 Salıncak Ön Alt Sol Rd1036	

FABIA
I SALOON 6Y3
1999 - 2006

Resim	Ürün Kodu ve Açıklaması	Detay	OEM
	SK20033003 ROT TAKIMI ÖN AKS SAĞ RC788115	Ağırlık : 1,021 kg / 2.251 lb Rotbaşı : SK2003 Rotmili : SK3003	6Q0422804B, 6Q0423804B
	SK20033004 ROT TAKIMI ÖN AKS SAĞ RC788117	Ağırlık : 0,915 kg / 2.017 lb Rotbaşı : SK2003 Rotmili : SK3004	6Q0422804G, 6Q0423804A
	SK20033007 ROT TAKIMI ÖN AKS SAĞ	Ağırlık : 0,96 kg / 2.116 lb Rotbaşı : SK2003 Rotmili : SK3007	
	SK20043003 ROT TAKIMI SOL RC788114	Ağırlık : 0,932 kg / 2.055 lb Rotbaşı : SK2004 Rotmili : SK3003	6Q0422803B, 6Q0423803B
	SK20043004 ROT TAKIMI ÖN AKS SOL RC788116	Ağırlık : 0,903 kg / 1.991 lb Rotbaşı : SK2004 Rotmili : SK3004	6Q0422803G, 6Q0423803A
	SK20043007 ROT TAKIMI ÖN AKS SOL	Ağırlık : 0,96 kg / 2.116 lb Rotbaşı : SK2004 Rotmili : SK3007	
	AU4001A Z ROT ÖN PLASTİK	Ağırlık : 0,295 kg / 0.650 lb Malzeme Türü : Plastik Uzunluk : 317 mm / 12.48 inch	893407465, 893407465A 8A0407465, 8A0407465B 8A0407465C
	AU4028 Z ROT ÖN	Ağırlık : 0,368 kg / 0.811 lb Malzeme Türü : Metal Uzunluk : 270 mm / 10.63 inch Aşık Diş Çapı : M10X1,5	6Q0411315L, 6Q0411315N 8Z0411315D
	SK6009 SALINCAK ÖN ALT SAĞ RD1035	Ağırlık : 2,676 kg / 5.900 lb Malzeme Türü : Sac Metal	6N0407151, 6Q0407151D* 6Q0407151D, 6Q0407151E* 6Q0407151E, 6Q0407151L 6Q0407151Z, 6Q0407366A*
	SK6009J SALINCAK ÖN ALT RD10211	Ağırlık : 2,626 kg / 5.789 lb Malzeme Türü : Sac Metal	6Q0407151D, 6Q0407151E 6Q0407151L
	SK6009K SALINCAK ÖN ALT SAĞ	Ağırlık : 3,13 kg / 6.900 lb Malzeme Türü : Sac Metal	6N0407151, 6Q0407151D 6Q0407151E, 6Q0407151L 6Q0407151Z

* Bu sayfada ve katalogdaki tüm araçların adları, markaları, modelleri, sembolleri, logoları, orjinal numaraları (oe) ve diğer üçüncü parti numaraları sadece referans amaçlı kullanılmaktadır.

FABIA
I SALOON 6Y3
1999 - 2006

Resim	Ürün Kodu ve Açıklaması	Detay	OEM
	SK6010 SALINCAK ÖN ALT SOL RD1036	Ağırlık : 3,13 kg / 6.900 lb Malzeme Türü : Sac Metal	6N040711, 6Q0407151D* 6Q0407151D, 6Q0407151E* 6Q0407151E, 6Q0407151L 6Q0407151Z, 6Q0407365A*
	SK6010K SALINCAK ÖN ALT SOL	Ağırlık : 3,13 kg / 6.900 lb Malzeme Türü : Sac Metal	6N040711, 6Q0407151D* 6Q0407151D, 6Q0407151E* 6Q0407151E, 6Q0407151L 6Q0407151Z, 6Q0407365A*
	VW11045 SALINCAK VE DENGE KOLU BURCU ORTA SOL VE SAĞ B40128	Yön : Orta Sol Ve Sağ Ağırlık : 0,145 kg / 0.320 lb	6Q0407182A
	VW11047 SALINCAK VE DENGE KOLU BURCU İÇ SOL VE SAĞ B37117	Yön : İç Sol Ve Sağ Ağırlık : 0,121 kg / 0.267 lb	1K0199231J, 1K0199231J-P 1K0407183E
	VW11051 SALINCAK VE DENGE KOLU BURCU SOL VE SAĞ	Yön : Sol Ve Sağ Ağırlık : 0.121 kg / 0.267 lb	6Q0407183, 6Q0407183A
	VW11055 SALINCAK VE DENGE KOLU BURCU İÇ SOL VE SAĞ	Yön : İç Sol Ve Sağ Ağırlık : 0.121 kg / 0.267 lb	1K0407183E, 8J0407183
	VW12066 TORSİYON BURCU SOL VE SAĞ	Yön : Sol Ve Sağ Ağırlık : 0.6 kg / 1.323 lb	1J0 501 541 D, 1J0501541D
	VW12015 VİRAJ DEMİR LASTİĞİ SOL VE SAĞ RUBBER	Şasi (Ön / Arka) : ÖN Yön : Sol Ve Sağ Ağırlık : 0.03 kg / 0.066 lb Malzeme Türü : Rubber Not : VİRAJ DEMİR LASTİĞİ	6Q0411303H, 6Q0411314E 6Q0411314N, 6Q0411314R
	VW12015K VİRAJ DEMİR LASTİĞİ SOL VE SAĞ RUBBER	Şasi (Ön / Arka) : ÖN Yön : Sol Ve Sağ Ağırlık : 0.06 kg / 0.132 lb Malzeme Türü : Rubber Not : VİRAJ LASTİĞİ (İKİLİ)	6Q0411303H*, 6Q0411303H 6Q0411314E*, 6Q0411314E 6Q0411314N*, 6Q0411314N 6Q0411314R*, 6Q0411314R
	VW12024 VİRAJ DEMİR LASTİĞİ SOL VE SAĞ RUBBER	Şasi (Ön / Arka) : ÖN Yön : Sol Ve Sağ Ağırlık : 0.03 kg / 0.066 lb Malzeme Türü : Rubber Not : VİRAJ LASTİĞİ	6Q0411303AA, 6Q0411303AD 6Q0411305H, 6Q0411314M 6Q0411314Q
	VW12024K VİRAJ DEMİR LASTİĞİ SOL VE SAĞ RUBBER	Şasi (Ön / Arka) : ÖN Yön : Sol Ve Sağ Ağırlık : 0.06 kg / 0.132 lb Malzeme Türü : Rubber Not : VİRAJ LASTİĞİ (İKİLİ)	6Q0411303AA*, 6Q0411303AA 6Q0411303AD*, 6Q0411303AD 6Q0411305H*, 6Q0411305H 6Q0411314M*, 6Q0411314M 6Q0411314Q*, 6Q0411314Q

* Bu sayfada ve katalogdaki tüm araçların adları, markaları, modelleri, sembolleri, logoları, orijinal numaraları (oe) ve diğer üçüncü parti numaraları sadece referans amaçlı kullanılmaktadır.

FABIA
I SALOON 6Y3
1999 - 2006

Resim	Ürün Kodu ve Açıklaması	Detay	OEM
	VW12049 VİRAJ DEMİR LASTİĞİ SOL VE SAĞ RUBBER	Şasi (Ön / Arka) : ÖN Yön : Sol Ve Sağ Ağırlık : 0.03 kg / 0.066 lb Malzeme Türü : Rubber Not : VİRAJ LASTİĞİ	8Z0411314B
	VW12049K VİRAJ DEMİR LASTİĞİ SOL VE SAĞ RUBBER	Şasi (Ön / Arka) : ÖN Yön : Sol Ve Sağ Ağırlık : 0.06 kg / 0.132 lb Malzeme Türü : Rubber	8Z0411314B*
	VW12062 VİRAJ DEMİR LASTİĞİ SOL VE SAĞ RUBBER	Şasi (Ön / Arka) : ÖN Yön : Sol Ve Sağ Ağırlık : 0.03 kg / 0.066 lb Malzeme Türü : Rubber Not : VİRAJ LASTİĞİ ÖN	6Q0411314F
	VW12062K VİRAJ DEMİR LASTİĞİ SOL VE SAĞ RUBBER	Şasi (Ön / Arka) : ÖN Yön : Sol Ve Sağ Ağırlık : 0.06 kg / 0.132 lb Malzeme Türü : Rubber	6Q0411314F*
	SK12002 AMORTİSÖR TAKOZU ARKA SOL VE SAĞ 1.2 / 1.4TSI / 1.6TDI / 1.2TDI	Şasi (Ön / Arka) : ARKA Yön : Sol Ve Sağ Ağırlık : 0.305 kg / 0.672 lb Not : 1.2 / 1.4TSI / 1.6TDI / 1.2TDI	1J0513353A, 1J0513353B 1J0513353C, 1J0513353G 6QE513353, 6R0513353 6R0513353B
	VW12109 AMORTİSÖR TAKOZU SOL VE SAĞ AMORTİSÖR RULMANI	Yön : Sol Ve Sağ Ağırlık : 0.26 kg / 0.573 lb Not : AMORTİSÖR RULMANI	6N0412249C, 6N0412249E
	VW12109K AMORTİSÖR TAKOZU SOL VE SAĞ 2 PCS	Yön : Sol Ve Sağ Ağırlık : 0.52 kg / 1.146 lb Not : 2 PCS	6N0412249C, 6N0412249E
	VW12115 AMORTİSÖR TAKOZU SOL VE SAĞ AMORTİSÖR TAKOZU	Yön : Sol Ve Sağ Ağırlık : 0.85 kg / 1.874 lb Not : AMORTİSÖR TAKOZU	6N0412331D, 6N0412331E 6Q0412331B
	VW12801 AMORTİSÖR TAKOZU SOL VE SAĞ KIT = VW12115 AND VW12109	Yön : Sol Ve Sağ Ağırlık : 1.269 kg / 2.798 lb Not : KIT = VW12115 and VW12109	6N0412249C, 6N0412249E 6N0412331D, 6N0412331E 6Q0412331B
	SE12005 MOTOR TAKOZU ARKA	Şasi (Ön / Arka) : ARKA Ağırlık : 1,115 kg / 2.458 lb	6Q0199851AS, 6Q0199851T
	VW12028 MOTOR TAKOZU SOL VE SAĞ MOTOR TAKOZU	Yön : Sol Ve Sağ Ağırlık : 1.1 kg / 2.425 lb Not : MOTOR TAKOZU	6Q0199851, 6Q0199851AK

* Bu sayfada ve katalogdaki tüm araçların adları, markaları, modelleri, sembolleri, logoları, orjinal numaraları (oe) ve diğer üçüncü parti numaraları sadece referans amaçlı kullanılmaktadır.

FABIA
I SALOON 6Y3
1999 - 2006









Resim	Ürün Kodu ve Açıklaması	Detay	OEM
	VW12069 MOTOR TAKOZU SOL VE SAĞ MOTOR TAKOZU	Yön : Sol Ve Sağ Ağırlık : 0.83 kg / 1.830 lb Not : MOTOR TAKOZU	6Q0199851AB, 6Q0199851AK
	VW12080 MOTOR TAKOZU SOL VE SAĞ MOTOR TAKOZU	Yön : Sol Ve Sağ Ağırlık : 2.02 kg / 4.453 lb Not : MOTOR TAKOZU	6Q0199167AQ, 6Q0199167BM 6Q0199167BQ, 6Q0199167BR 6Q0199167CA, 6Q0199167CB 6Q0199167CC, 6Q0199167CE 6Q0199167CJ, 6Q0199167CR
	VW12083 MOTOR TAKOZU SOL VE SAĞ MOTOR TAKOZU	Yön : Sol Ve Sağ Ağırlık : 1.95 kg / 4.299 lb Not : MOTOR TAKOZU	6Q0199167BC, 6Q0199167BN 6Q0199167CH, 6Q0199167CL 6Q0199167DA, 6Q0199167DB 6Q0199167DL, 6Q0199167DM 6R0199167AA
	VW12093 MOTOR TAKOZU SOL VE SAĞ MOTOR TAKOZU	Yön : Sol Ve Sağ Ağırlık : 1.05 kg / 2.315 lb Not : MOTOR TAKOZU	6Q0199851AC, 6Q0199851AL 6Q0199851AR, 6Q0199851E 6Q0199851S
	VW12123 MOTOR TAKOZU SOL ŞANZUMAN TAKOZU	Yön : Sol Ağırlık : 1.642 kg / 3.620 lb Malzeme Türü : Şanzuman Takozu	6Q0199555AE, 6Q0199555AT 6R0199555, 6RF199555A 6RF199555C
	VW12036 SÜSPANSİYON TAKOZU SOL VE SAĞ ARKA SÜSPANSİYON TAKOZU	Yön : Sol Ve Sağ Ağırlık : 1.591 kg / 3.508 lb Not : ARKA SÜSPANSİYON TAKOZU	6Q0512131B
	SK12006 EGZOZ TAKOZU	Ağırlık : 0,185 kg / 0.408 lb	6Q0253144B, 6Q0253144D
	AU14001 AKS KÖRÜĞÜ +KELEPÇE+YAĞ.	Ağırlık : 0.233 kg / 0.514 lb	6Q0498203A
	F114014 AKS KÖRÜĞÜ +KELEPÇE+YAĞ. DIŞ	Ağırlık : 0.211 kg / 0.465 lb	46307841
	VW14009 AKS KÖRÜĞÜ +KELEPÇE+YAĞ. DIŞ	Ağırlık : 0.16 kg / 0.353 lb	1H0407285B
	AU15001 AMORTİSÖR KÖRÜĞÜ ÖN	Şasi (Ön / Arka) : ÖN Ağırlık : 0,110 kg / 0.243 lb	6N0413175A

* Bu sayfada ve katalogdaki tüm araçların adları, markaları, modelleri, sembolleri, logoları, orijinal numaraları (oe) ve diğer üçüncü parti numaraları sadece referans amaçlı kullanılmaktadır.

FABIA
I SALOON 6Y3
1999 - 2007











Resim	Ürün Kodu ve Açıklaması	Detay	OEM
	AU4001 Z ROT SOL VE SAĞ METAL RB2911	Ağırlık : 0,357 kg / 0.787 lb Malzeme Türü : Metal Uzunluk : 270 mm / 10.63 inch Aşık Diş Çapı : M10X1,5	893407465, 893407465A 8A0407465, 8A0407465B 8A0407465C
	SK11011 TORSİYON BURCU SOL VE SAĞ	Yön : Sol Ve Sağ Ağırlık : 0,346 kg / 0.763 lb	6R0501541A

FABIA
II 542
2006 - 2014

Resim	Ürün Kodu ve Açıklaması	Detay	OEM
	SK1025 ROTİL SAĞ	Ağırlık : 0,59 kg / 1.301 lb Konik Ölçüsü : Ø15 Bağlantı Delik Çapı : Ø10,5 Aşık Diş Çapı : M12X1,5	5U0407366A, 6R0407366 6R0407366A, 6R0407366B
	SK1026 ROTİL ÖN ALT SOL Ø15	Ağırlık : 0,59 kg / 1.301 lb Konik Ölçüsü : Ø15 Bağlantı Delik Çapı : Ø10,5 Aşık Diş Çapı : M12X1,5	5U0407365A, 6R0407365 6R0407365A, 6R0407365B
	SK2003 ROTBAŞI SAĞ RC7314	Ağırlık : 0,377 kg / 0.831 lb Uzunluk : 93,5 mm / 3.68 inch Gövde Diş Çapı : M14X1,5 Aşık Diş Çapı : M12X1,5 Aşık Konik Çapı : Ø13,5	5Z0423812, 6Q0419812C 6Q0423812, 6Q0423812A 6Q0423812C, 6Q0423812D 6R0423812, 8Z0423811A
	SK2004 ROTBAŞI SOL RC7313	Ağırlık : 0,382 kg / 0.842 lb Uzunluk : 93 mm / 3.66 inch Gövde Diş Çapı : M14X1,5 Aşık Diş Çapı : M12X1,5 Aşık Konik Çapı : Ø13,5	5Z0423811, 6Q0419811C 6Q0423811, 6Q0423811A 6Q0423811C, 6Q0423811D 6R0423811, 8Z0423812A
	SK3005 ROTMİLİ L = 297	Ağırlık : 0,584 kg / 1.287 lb Uzunluk : 297 mm / 11.69 inch Gövde Diş Çapı : M16X1,5 Aşık Diş Çapı : M14X1,5	6Q0423810C
	AU4028 Z ROT ÖN	Ağırlık : 0,368 kg / 0.811 lb Malzeme Türü : Metal Uzunluk : 270 mm / 10.63 inch Aşık Diş Çapı : M10X1,5	6Q0411315L, 6Q0411315N 8Z0411315D
	SK4001 Z ROT ÖN METAL	Ağırlık : 0,357 kg / 0.787 lb Malzeme Türü : Metal Uzunluk : 270 mm / 10.63 inch Aşık Diş Çapı : M10X1,5	2Q0411315, 2Q0411315A 6Q0411315A, 6Q0411315E 6Q0411315F, 6Q0411315H 6Q0411315J, 6Q0411315M 6Q0411315P
	SK6013 SALINCAK ÖN ALT SAĞ	Ağırlık : 3,445 kg / 7.595 lb Malzeme Türü : Sac Metal	6R0407152, 6R0407152E

* Bu sayfada ve katalogdaki tüm araçların adları, markaları, modelleri, sembolleri, logoları, orjinal numaraları (oe) ve diğer üçüncü parti numaraları sadece referans amaçlı kullanılmaktadır.

FABIA
II 542
2006 - 2014

Resim	Ürün Kodu ve Açıklaması	Detay	OEM
	SK6013J SALINCAK ÖN ALT SAĞ	Ağırlık : 2,88 kg / 6.349 lb Malzeme Türü : Sac Metal	6R0407152
	SK6014 SALINCAK ÖN ALT SOL	Ağırlık : 3,445 kg / 7.595 lb Malzeme Türü : Sac Metal	6R0407151, 6R0407151E
	SK6014J SALINCAK ÖN ALT SOL	Ağırlık : 2,88 kg / 6.349 lb Malzeme Türü : Sac Metal	6R0407151, 6R0407151E
	AU11002 SALINCAK VE DENGE KOLU BURCU ÖN SOL VE SAĞ B22117	Şasi (Ön / Arka) : ÖN Yön : Sol Ve Sağ Ağırlık : 0,108 kg / 0.238 lb	1J0407181, 1J0407181A
	AU11005 SALINCAK VE DENGE KOLU BURCU ÖN ORTA SOL VE SAĞ B40115	Şasi (Ön / Arka) : ÖN Yön : Orta Sol Ve Sağ Ağırlık : 0,111 kg / 0.245 lb Not : VW6014 - VW60614J	191407182, 357407182 357407182F
	VW11051 SALINCAK VE DENGE KOLU BURCU SOL VE SAĞ	Yön : Sol Ve Sağ Ağırlık : 0.121 kg / 0.267 lb	6Q0407183, 6Q0407183A
	SK11011 TORSİYON BURCU SOL VE SAĞ	Yön : Sol Ve Sağ Ağırlık : 0,346 kg / 0.763 lb	6R0501541A
	VW12015 VİRAJ DEMİR LASTİĞİ SOL VE SAĞ RUBBER	Şasi (Ön / Arka) : ÖN Yön : Sol Ve Sağ Ağırlık : 0.03 kg / 0.066 lb Malzeme Türü : Rubber Not : VİRAJ DEMİR LASTİĞİ	6Q0411303H, 6Q0411314E 6Q0411314N, 6Q0411314R
	VW12015K VİRAJ DEMİR LASTİĞİ SOL VE SAĞ RUBBER	Şasi (Ön / Arka) : ÖN Yön : Sol Ve Sağ Ağırlık : 0.06 kg / 0.132 lb Malzeme Türü : Rubber Not : VİRAJ LASTİĞİ (İKİLİ)	6Q0411303H*, 6Q0411303H 6Q0411314E*, 6Q0411314E 6Q0411314N*, 6Q0411314N 6Q0411314R*, 6Q0411314R
	VW12024 VİRAJ DEMİR LASTİĞİ SOL VE SAĞ RUBBER	Şasi (Ön / Arka) : ÖN Yön : Sol Ve Sağ Ağırlık : 0.03 kg / 0.066 lb Malzeme Türü : Rubber Not : VİRAJ LASTİĞİ	6Q0411303AA, 6Q0411303AD 6Q0411305H, 6Q0411314M 6Q0411314Q
	VW12024K VİRAJ DEMİR LASTİĞİ SOL VE SAĞ RUBBER	Şasi (Ön / Arka) : ÖN Yön : Sol Ve Sağ Ağırlık : 0.06 kg / 0.132 lb Malzeme Türü : Rubber Not : VİRAJ LASTİĞİ (İKİLİ)	6Q0411303AA*, 6Q0411303AA 6Q0411303AD*, 6Q0411303AD 6Q0411305H*, 6Q0411305H 6Q0411314M*, 6Q0411314M 6Q0411314Q*, 6Q0411314Q











* Bu sayfada ve katalogdaki tüm araçların adları, markaları, modelleri, sembolleri, logoları, orjinal numaraları (oe) ve diğer üçüncü parti numaraları sadece referans amaçlı kullanılmaktadır.

FABIA
II 542
2006 - 2014

Resim	Ürün Kodu ve Açıklaması	Detay	OEM
	VW12050 VİRAJ DEMİR LASTİĞİ SOL VE SAĞ RUBBER	Şasi (Ön / Arka) : ÖN Yön : Sol Ve Sağ Ağırlık : 0.04 kg / 0.088 lb Malzeme Türü : Rubber Not : VİRAJ LASTİĞİ	6Q0411314P
	VW12050K VİRAJ DEMİR LASTİĞİ SOL VE SAĞ RUBBER	Şasi (Ön / Arka) : ÖN Yön : Sol Ve Sağ Ağırlık : 0.08 kg / 0.176 lb Malzeme Türü : Rubber Not : VİRAJ LASTİĞİ (İKİLİ)	6Q0411314P*, 6Q0411314P
	SK12002 AMORTİSÖR TAKOZU ARKA SOL VE SAĞ 1.2 / 1.4TSI / 1.6TDI / 1.2TDI	Şasi (Ön / Arka) : ARKA Yön : Sol Ve Sağ Ağırlık : 0.305 kg / 0.672 lb Not : 1.2 / 1.4TSI / 1.6TDI / 1.2TDI	1J0513353A, 1J0513353B 1J0513353C, 1J0513353G 6QE513353, 6R0513353 6R0513353B
	VW12061 AMORTİSÖR TAKOZU SOL VE SAĞ AMORTİSÖR TAKOZU	Yön : Sol Ve Sağ Ağırlık : 0.27 kg / 0.595 lb Not : AMORTİSÖR TAKOZU	1H0412365A, 1J0412249 1J0412331BS, 1J0412331C
	VW12061A AMORTİSÖR TAKOZU SOL VE SAĞ AMORTİSÖR RULMANI	Yön : Sol Ve Sağ Ağırlık : 0.08 kg / 0.176 lb Not : AMORTİSÖR RULMANI	1J0412249, 1J0412249C 357412249, 357412249A 4503300051, 7201688 7201848, 95VW3K031AA
	VW12061K AMORTİSÖR TAKOZU SOL VE SAĞ 2 PCS	Yön : Sol Ve Sağ Ağırlık : 0.7 kg / 1.543 lb Not : 2 PCS	1H0412365A, 1J0412249 1J0412331BS, 1J0412331C
	VW12103 AMORTİSÖR TAKOZU SOL VE SAĞ AMORTİSÖR ÜST TAKOZU	Yön : Sol Ve Sağ Ağırlık : 0.23 kg / 0.507 lb Not : AMORTİSÖR ÜST TAKOZU	1J0412331B, 1J0412331C
	VW12109 AMORTİSÖR TAKOZU SOL VE SAĞ AMORTİSÖR RULMANI	Yön : Sol Ve Sağ Ağırlık : 0.26 kg / 0.573 lb Not : AMORTİSÖR RULMANI	6N0412249C, 6N0412249E
	VW12109K AMORTİSÖR TAKOZU SOL VE SAĞ 2 PCS	Yön : Sol Ve Sağ Ağırlık : 0.52 kg / 1.146 lb Not : 2 PCS	6N0412249C, 6N0412249E
	VW12115 AMORTİSÖR TAKOZU SOL VE SAĞ AMORTİSÖR TAKOZU	Yön : Sol Ve Sağ Ağırlık : 0.85 kg / 1.874 lb Not : AMORTİSÖR TAKOZU	6N0412331D, 6N0412331E 6Q0412331B
	VW12801 AMORTİSÖR TAKOZU SOL VE SAĞ KIT = VW12115 AND VW12109	Yön : Sol Ve Sağ Ağırlık : 1.269 kg / 2.798 lb Not : KIT = VW12115 and VW12109	6N0412249C, 6N0412249E 6N0412331D, 6N0412331E 6Q0412331B

* Bu sayfada ve katalogdaki tüm araçların adları, markaları, modelleri, sembolleri, logoları, orjinal numaraları (oe) ve diğer üçüncü parti numaraları sadece referans amaçlı kullanılmaktadır.

FABIA
II 542
2006 - 2014

Resim	Ürün Kodu ve Açıklaması	Detay	OEM
	VW12028 MOTOR TAKOZU SOL VE SAĞ MOTOR TAKOZU	Yön : Sol Ve Sağ Ağırlık : 1.1 kg / 2.425 lb Not : MOTOR TAKOZU	6Q0199851, 6Q0199851AK
	VW12069 MOTOR TAKOZU SOL VE SAĞ MOTOR TAKOZU	Yön : Sol Ve Sağ Ağırlık : 0.83 kg / 1.830 lb Not : MOTOR TAKOZU	6Q0199851AB, 6Q0199851AK
	VW12080 MOTOR TAKOZU SOL VE SAĞ MOTOR TAKOZU	Yön : Sol Ve Sağ Ağırlık : 2.02 kg / 4.453 lb Not : MOTOR TAKOZU	6Q0199167AQ, 6Q0199167BM 6Q0199167BQ, 6Q0199167BR 6Q0199167CA, 6Q0199167CB 6Q0199167CC, 6Q0199167CE 6Q0199167CJ, 6Q0199167CR
	VW12083 MOTOR TAKOZU SOL VE SAĞ MOTOR TAKOZU	Yön : Sol Ve Sağ Ağırlık : 1.95 kg / 4.299 lb Not : MOTOR TAKOZU	6Q0199167BC, 6Q0199167BN 6Q0199167CH, 6Q0199167CL 6Q0199167DA, 6Q0199167DB 6Q0199167DL, 6Q0199167DM 6R0199167AA
	VW12093 MOTOR TAKOZU SOL VE SAĞ MOTOR TAKOZU	Yön : Sol Ve Sağ Ağırlık : 1.05 kg / 2.315 lb Not : MOTOR TAKOZU	6Q0199851AC, 6Q0199851AL 6Q0199851AR, 6Q0199851E 6Q0199851S
	VW12123 MOTOR TAKOZU SOL ŞANZUMAN TAKOZU	Yön : Sol Ağırlık : 1.642 kg / 3.620 lb Malzeme Türü : Şanzuman Takozu	6Q0199555AE, 6Q0199555AT 6R0199555, 6RF199555A 6RF199555C
	VW12036 SÜSPANSİYON TAKOZU SOL VE SAĞ ARKA SÜSPANSİYON TAKOZU	Yön : Sol Ve Sağ Ağırlık : 1.591 kg / 3.508 lb Not : ARKA SÜSPANSİYON TAKOZU	6Q0512131B
	VW12101 SÜSPANSİYON TAKOZU SOL VE SAĞ SÜSPANSİYON TAKOZU	Yön : Sol Ve Sağ Ağırlık : 0.07 kg / 0.154 lb Not : SÜSPANSİYON TAKOZU	6Q0512131C
	SK12006 EGZOZ TAKOZU	Ağırlık : 0,185 kg / 0.408 lb	6Q0253144B, 6Q0253144D
	VW12086 RADYATÖR TAKOZU SOL VE SAĞ RADYATÖR ÜST LASTİĞİ	Yön : Sol Ve Sağ Ağırlık : 0.024 kg / 0.053 lb Not : RADYATÖR ÜST LASTİĞİ	1K0121367F
	AU14001 AKS KÖRÜĞÜ +KELEPÇE+YAĞ.	Ağırlık : 0.233 kg / 0.514 lb	6Q0498203A

* Bu sayfada ve katalogdaki tüm araçların adları, markaları, modelleri, sembolleri, logoları, orjinal numaraları (oe) ve diğer üçüncü parti numaraları sadece referans amaçlı kullanılmaktadır.

FABIA II 542 2006 - 2014











Resim	Ürün Kodu ve Açıklaması	Detay	OEM
	VW14003 AKS KÖRÜĞÜ +KELEPÇE+YAĞ. DIŞ	Ağırlık : 0.25 kg / 0.551 lb	1K0 498 203, 1K0498203
	VW14009 AKS KÖRÜĞÜ +KELEPÇE+YAĞ. DIŞ	Ağırlık : 0.16 kg / 0.353 lb	1H0407285B
	AU15001 AMORTİSÖR KÖRÜĞÜ ÖN	Şasi (Ön / Arka) : ÖN Ağırlık : 0,110 kg / 0.243 lb	6N0413175A

FABIA II COMBI 545 2006 - 2014

Resim	Ürün Kodu ve Açıklaması	Detay	OEM
	SK1025 ROTİL SAĞ	Ağırlık : 0,59 kg / 1.301 lb Konik Ölçüsü : Ø15 Bağlantı Delik Çapı : Ø10,5 Aşık Diş Çapı : M12X1,5	5U0407366A, 6R0407366 6R0407366A, 6R0407366B
	SK1026 ROTİL ÖN ALT SOL Ø15	Ağırlık : 0,59 kg / 1.301 lb Konik Ölçüsü : Ø15 Bağlantı Delik Çapı : Ø10,5 Aşık Diş Çapı : M12X1,5	5U0407365A, 6R0407365 6R0407365A, 6R0407365B
	SK2003 ROTBAŞI SAĞ RC7314	Ağırlık : 0,377 kg / 0.831 lb Uzunluk : 93,5 mm / 3.68 inch Gövde Diş Çapı : M14X1,5 Aşık Diş Çapı : M12X1,5 Aşık Konik Çapı : Ø13,5	5Z0423812, 6Q0419812C 6Q0423812, 6Q0423812A 6Q0423812C, 6Q0423812D 6R0423812, 8Z0423811A
	SK2004 ROTBAŞI SOL RC7313	Ağırlık : 0,382 kg / 0.842 lb Uzunluk : 93 mm / 3.66 inch Gövde Diş Çapı : M14X1,5 Aşık Diş Çapı : M12X1,5 Aşık Konik Çapı : Ø13,5	5Z0423811, 6Q0419811C 6Q0423811, 6Q0423811A 6Q0423811C, 6Q0423811D 6R0423811, 8Z0423812A
	SK3005 ROTMİLİ L = 297	Ağırlık : 0,584 kg / 1.287 lb Uzunluk : 297 mm / 11.69 inch Gövde Diş Çapı : M16X1,5 Aşık Diş Çapı : M14X1,5	6Q0423810C
	AU4028 Z ROT ÖN	Ağırlık : 0,368 kg / 0.811 lb Malzeme Türü : Metal Uzunluk : 270 mm / 10.63 inch Aşık Diş Çapı : M10X1,5	6Q0411315L, 6Q0411315N 8Z0411315D
	SK6013 SALINCAK ÖN ALT SAĞ	Ağırlık : 3,445 kg / 7.595 lb Malzeme Türü : Sac Metal	6R0407152, 6R0407152E

* Bu sayfada ve katalogdaki tüm araçların adları, markaları, modelleri, sembolleri, logoları, orjinal numaraları (oe) ve diğer üçüncü parti numaraları sadece referans amaçlı kullanılmaktadır.

FABIA
II COMBI 545
2006 - 2014

Resim	Ürün Kodu ve Açıklaması	Detay	OEM
	SK6013J SALINCAK ÖN ALT SAĞ	Ağırlık : 2,88 kg / 6.349 lb Malzeme Türü : Sac Metal	6R0407152
	SK6014 SALINCAK ÖN ALT SOL	Ağırlık : 3,445 kg / 7.595 lb Malzeme Türü : Sac Metal	6R0407151, 6R0407151E
	SK6014J SALINCAK ÖN ALT SOL	Ağırlık : 2,88 kg / 6.349 lb Malzeme Türü : Sac Metal	6R0407151, 6R0407151E
	AU11002 SALINCAK VE DENGE KOLU BURCU ÖN SOL VE SAĞ B22117	Şasi (Ön / Arka) : ÖN Yön : Sol Ve Sağ Ağırlık : 0,108 kg / 0.238 lb	1J0407181, 1J0407181A
	AU11005 SALINCAK VE DENGE KOLU BURCU ÖN ORTA SOL VE SAĞ B40115	Şasi (Ön / Arka) : ÖN Yön : Orta Sol Ve Sağ Ağırlık : 0,111 kg / 0.245 lb Not : VW6014 - VW60614J	191407182, 357407182 357407182F
	VW11051 SALINCAK VE DENGE KOLU BURCU SOL VE SAĞ	Yön : Sol Ve Sağ Ağırlık : 0.121 kg / 0.267 lb	6Q0407183, 6Q0407183A
	VW12015 VİRAJ DEMİR LASTİĞİ SOL VE SAĞ RUBBER	Şasi (Ön / Arka) : ÖN Yön : Sol Ve Sağ Ağırlık : 0.03 kg / 0.066 lb Malzeme Türü : Rubber Not : VİRAJ DEMİR LASTİĞİ	6Q0411303H, 6Q0411314E 6Q0411314N, 6Q0411314R
	VW12015K VİRAJ DEMİR LASTİĞİ SOL VE SAĞ RUBBER	Şasi (Ön / Arka) : ÖN Yön : Sol Ve Sağ Ağırlık : 0.06 kg / 0.132 lb Malzeme Türü : Rubber Not : VİRAJ LASTİĞİ (İKİLİ)	6Q0411303H*, 6Q0411303H 6Q0411314E*, 6Q0411314E 6Q0411314N*, 6Q0411314N 6Q0411314R*, 6Q0411314R
	VW12024 VİRAJ DEMİR LASTİĞİ SOL VE SAĞ RUBBER	Şasi (Ön / Arka) : ÖN Yön : Sol Ve Sağ Ağırlık : 0.03 kg / 0.066 lb Malzeme Türü : Rubber Not : VİRAJ LASTİĞİ	6Q0411303AA, 6Q0411303AD 6Q0411305H, 6Q0411314M 6Q0411314Q
	VW12024K VİRAJ DEMİR LASTİĞİ SOL VE SAĞ RUBBER	Şasi (Ön / Arka) : ÖN Yön : Sol Ve Sağ Ağırlık : 0.06 kg / 0.132 lb Malzeme Türü : Rubber Not : VİRAJ LASTİĞİ (İKİLİ)	6Q0411303AA*, 6Q0411303AA 6Q0411303AD*, 6Q0411303AD 6Q0411305H*, 6Q0411305H 6Q0411314M*, 6Q0411314M 6Q0411314Q*, 6Q0411314Q
	VW12050 VİRAJ DEMİR LASTİĞİ SOL VE SAĞ RUBBER	Şasi (Ön / Arka) : ÖN Yön : Sol Ve Sağ Ağırlık : 0.04 kg / 0.088 lb Malzeme Türü : Rubber Not : VİRAJ LASTİĞİ	6Q0411314P

* Bu sayfada ve katalogdaki tüm araçların adları, markaları, modelleri, sembolleri, logoları, orijinal numaraları (oe) ve diğer üçüncü parti numaraları sadece referans amaçlı kullanılmaktadır.

FABIA
II COMBI 545
2006 - 2014

Resim	Ürün Kodu ve Açıklaması	Detay	OEM
	VW12050K VİRAJ DEMİR LASTİĞİ SOL VE SAĞ RUBBER	Şasi (Ön / Arka) : ÖN Yön : Sol Ve Sağ Ağırlık : 0.08 kg / 0.176 lb Malzeme Türü : Rubber Not : VİRAJ LASTİĞİ (İKİLİ)	6Q0411314P*, 6Q0411314P
	VW12061 AMORTİSÖR TAKOZU SOL VE SAĞ AMORTİSÖR TAKOZU	Yön : Sol Ve Sağ Ağırlık : 0.27 kg / 0.595 lb Not : AMORTİSÖR TAKOZU	1H0412365A, 1J0412249 1J0412331BS, 1J0412331C
	VW12061A AMORTİSÖR TAKOZU SOL VE SAĞ AMORTİSÖR RULMANI	Yön : Sol Ve Sağ Ağırlık : 0.08 kg / 0.176 lb Not : AMORTİSÖR RULMANI	1J0412249, 1J0412249C 357412249, 357412249A 4503300051, 7201688 7201848, 95VW3K031AA
	VW12061K AMORTİSÖR TAKOZU SOL VE SAĞ 2 PCS	Yön : Sol Ve Sağ Ağırlık : 0.7 kg / 1.543 lb Not : 2 PCS	1H0412365A, 1J0412249 1J0412331BS, 1J0412331C
	VW12103 AMORTİSÖR TAKOZU SOL VE SAĞ AMORTİSÖR ÜST TAKOZU	Yön : Sol Ve Sağ Ağırlık : 0.23 kg / 0.507 lb Not : AMORTİSÖR ÜST TAKOZU	1J0412331B, 1J0412331C
	VW12109 AMORTİSÖR TAKOZU SOL VE SAĞ AMORTİSÖR RULMANI	Yön : Sol Ve Sağ Ağırlık : 0.26 kg / 0.573 lb Not : AMORTİSÖR RULMANI	6N0412249C, 6N0412249E
	VW12109K AMORTİSÖR TAKOZU SOL VE SAĞ 2 PCS	Yön : Sol Ve Sağ Ağırlık : 0.52 kg / 1.146 lb Not : 2 PCS	6N0412249C, 6N0412249E
	VW12115 AMORTİSÖR TAKOZU SOL VE SAĞ AMORTİSÖR TAKOZU	Yön : Sol Ve Sağ Ağırlık : 0.85 kg / 1.874 lb Not : AMORTİSÖR TAKOZU	6N0412331D, 6N0412331E 6Q0412331B
	VW12801 AMORTİSÖR TAKOZU SOL VE SAĞ KIT = VW12115 AND VW12109	Yön : Sol Ve Sağ Ağırlık : 1.269 kg / 2.798 lb Not : KIT = VW12115 and VW12109	6N0412249C, 6N0412249E 6N0412331D, 6N0412331E 6Q0412331B
	VW12028 MOTOR TAKOZU SOL VE SAĞ MOTOR TAKOZU	Yön : Sol Ve Sağ Ağırlık : 1.1 kg / 2.425 lb Not : MOTOR TAKOZU	6Q0199851, 6Q0199851AK
	VW12069 MOTOR TAKOZU SOL VE SAĞ MOTOR TAKOZU	Yön : Sol Ve Sağ Ağırlık : 0.83 kg / 1.830 lb Not : MOTOR TAKOZU	6Q0199851AB, 6Q0199851AK

* Bu sayfada ve katalogdaki tüm araçların adları, markaları, modelleri, sembolleri, logoları, orijinal numaraları (oe) ve diğer üçüncü parti numaraları sadece referans amaçlı kullanılmaktadır.

FABIA
II COMBI 545
2006 - 2014

Resim	Ürün Kodu ve Açıklaması	Detay	OEM
	VW12080 MOTOR TAKOZU SOL VE SAĞ MOTOR TAKOZU	Yön : Sol Ve Sağ Ağırlık : 2.02 kg / 4.453 lb Not : MOTOR TAKOZU	6Q0199167AQ, 6Q0199167BM 6Q0199167BQ, 6Q0199167BR 6Q0199167CA, 6Q0199167CB 6Q0199167CC, 6Q0199167CE 6Q0199167CJ, 6Q0199167CR
	VW12083 MOTOR TAKOZU SOL VE SAĞ MOTOR TAKOZU	Yön : Sol Ve Sağ Ağırlık : 1.95 kg / 4.299 lb Not : MOTOR TAKOZU	6Q0199167BC, 6Q0199167BN 6Q0199167CH, 6Q0199167CL 6Q0199167DA, 6Q0199167DB 6Q0199167DL, 6Q0199167DM 6R0199167AA
	VW12093 MOTOR TAKOZU SOL VE SAĞ MOTOR TAKOZU	Yön : Sol Ve Sağ Ağırlık : 1.05 kg / 2.315 lb Not : MOTOR TAKOZU	6Q0199851AC, 6Q0199851AL 6Q0199851AR, 6Q0199851E 6Q0199851S
	VW12123 MOTOR TAKOZU SOL ŞANZUMAN TAKOZU	Yön : Sol Ağırlık : 1.642 kg / 3.620 lb Malzeme Türü : Şanzuman Takozu	6Q0199555AE, 6Q0199555AT 6R0199555, 6RF199555A 6RF199555C
	VW12036 SÜSPANSİYON TAKOZU SOL VE SAĞ ARKA SÜSPANSİYON TAKOZU	Yön : Sol Ve Sağ Ağırlık : 1.591 kg / 3.508 lb Not : ARKA SÜSPANSİYON TAKOZU	6Q0512131B
	VW12101 SÜSPANSİYON TAKOZU SOL VE SAĞ SÜSPANSİYON TAKOZU	Yön : Sol Ve Sağ Ağırlık : 0.07 kg / 0.154 lb Not : SÜSPANSİYON TAKOZU	6Q0512131C
	SK12006 EGZOZ TAKOZU	Ağırlık : 0,185 kg / 0.408 lb	6Q0253144B, 6Q0253144D
	VW12086 RADYATÖR TAKOZU SOL VE SAĞ RADYATÖR ÜST LASTİĞİ	Yön : Sol Ve Sağ Ağırlık : 0.024 kg / 0.053 lb Not : RADYATÖR ÜST LASTİĞİ	1K0121367F
	AU14001 AKS KÖRÜĞÜ +KELEPÇE+YAĞ.	Ağırlık : 0.233 kg / 0.514 lb	6Q0498203A
	VW14003 AKS KÖRÜĞÜ +KELEPÇE+YAĞ. DIŞ	Ağırlık : 0.25 kg / 0.551 lb	1K0 498 203, 1K0498203
	VW14009 AKS KÖRÜĞÜ +KELEPÇE+YAĞ. DIŞ	Ağırlık : 0.16 kg / 0.353 lb	1H0407285B

* Bu sayfada ve katalogdaki tüm araçların adları, markaları, modelleri, sembolleri, logoları, orjinal numaraları (oe) ve diğer üçüncü parti numaraları sadece referans amaçlı kullanılmaktadır.





FABIA II COMBI 545 2006 - 2014

Resim	Ürün Kodu ve Açıklaması	Detay	OEM
	AU15001 AMORTİSÖR KÖRÜĞÜ ÖN	Şasi (Ön / Arka) : ÖN Ağırlık : 0,110 kg / 0.243 lb	6N0413175A

FABIA II COMBI 545 2007 - 2014









Resim	Ürün Kodu ve Açıklaması	Detay	OEM
	SK4001 Z ROT ÖN METAL	Ağırlık : 0,357 kg / 0.787 lb Malzeme Türü : Metal Uzunluk : 270 mm / 10.63 inch Aşık Diş Çapı : M10X1,5	2Q0411315, 2Q0411315A 6Q0411315A, 6Q0411315E 6Q0411315F, 6Q0411315H 6Q0411315J, 6Q0411315M 6Q0411315P
	SK11011 TORSİYON BURCU SOL VE SAĞ	Yön : Sol Ve Sağ Ağırlık : 0,346 kg / 0.763 lb	6R0501541A

FABIA III NJ3, NJ5 2015 - 2023

Resim	Ürün Kodu ve Açıklaması	Detay	OEM
	SK1025 ROTİL SAĞ	Ağırlık : 0,59 kg / 1.301 lb Konik Ölçüsü : Ø15 Bağlantı Delik Çapı : Ø10,5 Aşık Diş Çapı : M12X1,5	5U0407366A, 6R0407366 6R0407366A, 6R0407366B
	SK1026 ROTİL ÖN ALT SOL Ø15	Ağırlık : 0,59 kg / 1.301 lb Konik Ölçüsü : Ø15 Bağlantı Delik Çapı : Ø10,5 Aşık Diş Çapı : M12X1,5	5U0407365A, 6R0407365 6R0407365A, 6R0407365B
	SK2007 ROTBAŞI SOL	Ağırlık : 0,420 kg / 0.926 lb Uzunluk : 94 mm / 3.70 inch Gövde Diş Çapı : M14X1,5 Aşık Diş Çapı : M12X1,5 Aşık Konik Çapı : Ø13,3	6C0423811A
	AU3012 ROTMİLİ SAĞ-SOL M14X1,5 L=312MM	Ağırlık : 0,6 kg / 1.323 lb Uzunluk : 312 mm / 12.28 inch Gövde Diş Çapı : M14X1,5 Aşık Diş Çapı : M14X1,5	6C0423810A, 6C0423810B 6C0423810C
	SK12002 AMORTİSÖR TAKOZU ARKA SOL VE SAĞ 1.2 / 1.4TSI / 1.6TDI / 1.2TDI	Şasi (Ön / Arka) : ARKA Yön : Sol Ve Sağ Ağırlık : 0,305 kg / 0.672 lb Not : 1.2 / 1.4TSI / 1.6TDI / 1.2TDI	1J0513353A, 1J0513353B 1J0513353C, 1J0513353G 6QE513353, 6R0513353 6R0513353B
	VW12103 AMORTİSÖR TAKOZU SOL VE SAĞ AMORTİSÖR ÜST TAKOZU	Yön : Sol Ve Sağ Ağırlık : 0,23 kg / 0.507 lb Not : AMORTİSÖR ÜST TAKOZU	1J0412331B, 1J0412331C

* Bu sayfada ve katalogdaki tüm araçların adları, markaları, modelleri, sembolleri, logoları, orjinal numaraları (oe) ve diğer üçüncü parti numaraları sadece referans amaçlı kullanılmaktadır.

FABIA
III NJ3, NJ5
2015 - 2023











Resim	Ürün Kodu ve Açıklaması	Detay	OEM
	SE12001 MOTOR TAKOZU ÖN SOL VE SAĞ	Şasi (Ön / Arka) : ÖN Yön : Sol Ve Sağ Ağırlık : 1,360 kg / 2.998 lb	6C0199851J
	SE12002 MOTOR TAKOZU ÖN SOL VE SAĞ	Şasi (Ön / Arka) : ÖN Yön : Sol Ve Sağ Ağırlık : 1,100 kg / 2.425 lb	6C0199851
	SE12003 MOTOR TAKOZU ÖN SOL VE SAĞ	Şasi (Ön / Arka) : ÖN Yön : Sol Ve Sağ Ağırlık : 1,900 kg / 4.189 lb	6C0199167B
	SE12004 MOTOR TAKOZU ÖN SOL VE SAĞ	Şasi (Ön / Arka) : ÖN Yön : Sol Ve Sağ Ağırlık : 1,300 kg / 2.866 lb	6C0199262A
	VW12123 MOTOR TAKOZU SOL ŞANZUMAN TAKOZU	Yön : Sol Ağırlık : 1.642 kg / 3.620 lb Malzeme Türü : Şanzuman Takozu	6Q0199555AE, 6Q0199555AT 6R0199555, 6RF199555A 6RF199555C
	VW12036 SÜSPANSİYON TAKOZU SOL VE SAĞ ARKA SÜSPANSİYON TAKOZU	Yön : Sol Ve Sağ Ağırlık : 1.591 kg / 3.508 lb Not : ARKA SÜSPANSİYON TAKOZU	6Q0512131B
	VW12086 RADYATÖR TAKOZU SOL VE SAĞ RADYATÖR ÜST LASTİĞİ	Yön : Sol Ve Sağ Ağırlık : 0.024 kg / 0.053 lb Not : RADYATÖR ÜST LASTİĞİ	1K0121367F
	AU14001 AKS KÖRÜĞÜ +KELEPÇE+YAĞ.	Ağırlık : 0.233 kg / 0.514 lb	6Q0498203A

FAVORIT
781
1991 - 1995

Resim	Ürün Kodu ve Açıklaması	Detay	OEM
	SK1022 ROTİL ALT SAĞ-SOL RC7511	Ağırlık : 0,42 kg / 0.926 lb Bağlantı Delik Çapı : Ø8,5	115420240, 6U0407365 6U0407807
	SK2002 ROTBAŞI SAĞ-SOL M12X1	Ağırlık : 0,316 kg / 0.697 lb Uzunluk : 79 mm / 3.11 inch Gövde Diş Çapı : M12X1 Aşık Diş Çapı : M12X1,25 Aşık Konik Çapı : Ø12,5	007350278P, 115500440 6U0422811

* Bu sayfada ve katalogdaki tüm araçların adları, markaları, modelleri, sembolleri, logoları, orjinal numaraları (oe) ve diğer üçüncü parti numaraları sadece referans amaçlı kullanılmaktadır.

FAVORIT
781
1991 - 1995

Resim	Ürün Kodu ve Açıklaması	Detay	OEM
	SK3006 ROTMİLİ SAĞ-SOL RC7811	Ağırlık : 0.415 kg / 0.915 lb Uzunluk : 334 mm / 13.15 inch Aşık Diş Çapı : M12X1	115500420
	SK6001 SALINCAK ÖN ALT SAĞ RC8011	Ağırlık : 2,637 kg / 5.814 lb Malzeme Türü : Sac Metal	, 115420021 115420024
	SK6002 SALINCAK ÖN ALT SOL RC8012	Ağırlık : 2,636 kg / 5.811 lb Malzeme Türü : Sac Metal	115420020, 115420023
	SK6003 SALINCAK ÖN ALT SAĞ RC8015	Ağırlık : 2,7 kg / 5.952 lb Malzeme Türü : Sac Metal	115420024
	SK6004 SALINCAK ÖN ALT SOL RC8016	Ağırlık : 2,679 kg / 5.906 lb Malzeme Türü : Sac Metal	115420023
	SK11003 SALINCAK VE DENGE KOLU BURCU SOL VE SAĞ B37112	Yön : Sol Ve Sağ Ağırlık : 0,111 kg / 0.245 lb	115422291
	SK11004 SALINCAK VE DENGE KOLU BURCU SOL VE SAĞ B37114	Yön : Sol Ve Sağ Ağırlık : 0,24 kg / 0.529 lb	115422292
	SK11005 SALINCAK VE DENGE KOLU BURCU ÖN SOL VE SAĞ B37113	Şasi (Ön / Arka) : ÖN Yön : Sol Ve Sağ Ağırlık : 0,086 kg / 0.190 lb	115422290, 6U0407182
	FI13013 DİREKSİYON KÖRÜĞÜ SAĞ	Ağırlık : 0.1 kg / 0.220 lb	114509823, 4239459 4371156, 7583243
	FI13014 DİREKSİYON KÖRÜĞÜ SOL	Ağırlık : 0.062 kg / 0.137 lb	114509823, 4239459 4371156, 7583243 9939039
	SK14002 AKS KÖRÜĞÜ +KELEPÇE+YAĞ. İÇ YENİ MODEL	Ağırlık : 0.232 kg / 0.511 lb	115429823, 95 640 970 95640970

* Bu sayfada ve katalogdaki tüm araçların adları, markaları, modelleri, sembolleri, logoları, orjinal numaraları (oe) ve diğer üçüncü parti numaraları sadece referans amaçlı kullanılmaktadır.

FAVORIT
781
1991 - 1995





Resim	Ürün Kodu ve Açıklaması	Detay	OEM
	SK14003 AKS KÖRÜĞÜ +KELEPÇE+YAĞ. İÇ ESKİ MODEL	Ağırlık : 0.2 kg / 0.441 lb	114429820

FAVORIT
FORMAN 785
1991 - 1995





Resim	Ürün Kodu ve Açıklaması	Detay	OEM
	SK1022 ROTİL ALT SAĞ-SOL RC7511	Ağırlık : 0,42 kg / 0.926 lb Bağlantı Delik Çapı : Ø8,5	115420240, 6U0407365 6U0407807
	SK2002 ROTBAŞI SAĞ-SOL M12X1	Ağırlık : 0,316 kg / 0.697 lb Uzunluk : 79 mm / 3.11 inch Gövde Diş Çapı : M12X1 Aşık Diş Çapı : M12X1,25 Aşık Konik Çapı : Ø12,5	007350278P, 115500440 6U0422811
	SK3006 ROTMİLİ SAĞ-SOL RC7811	Ağırlık : 0.415 kg / 0.915 lb Uzunluk : 334 mm / 13.15 inch Aşık Diş Çapı : M12X1	115500420
	SK6001 SALINCAK ÖN ALT SAĞ RC8011	Ağırlık : 2,637 kg / 5.814 lb Malzeme Türü : Sac Metal	, 115420021 115420024
	SK6002 SALINCAK ÖN ALT SOL RC8012	Ağırlık : 2,636 kg / 5.811 lb Malzeme Türü : Sac Metal	115420020, 115420023
	SK6003 SALINCAK ÖN ALT SAĞ RC8015	Ağırlık : 2,7 kg / 5.952 lb Malzeme Türü : Sac Metal	115420024
	SK6004 SALINCAK ÖN ALT SOL RC8016	Ağırlık : 2,679 kg / 5.906 lb Malzeme Türü : Sac Metal	115420023
	SK11003 SALINCAK VE DENGE KOLU BURCU SOL VE SAĞ B37112	Yön : Sol Ve Sağ Ağırlık : 0,111 kg / 0.245 lb	115422291
	SK11004 SALINCAK VE DENGE KOLU BURCU SOL VE SAĞ B37114	Yön : Sol Ve Sağ Ağırlık : 0,24 kg / 0.529 lb	115422292

* Bu sayfada ve katalogdaki tüm araçların adları, markaları, modelleri, sembolleri, logoları, orjinal numaraları (oe) ve diğer üçüncü parti numaraları sadece referans amaçlı kullanılmaktadır.

FAVORIT
FORMAN 785
1991 - 1995







Resim	Ürün Kodu ve Açıklaması	Detay	OEM
	SK11005 SALINCAK VE DENGE KOLU BURCU ÖN SOL VE SAĞ B37113	Şasi (Ön / Arka) : ÖN Yön : Sol Ve Sağ Ağırlık : 0,086 kg / 0.190 lb	115422290, 6U0407182
	FI13013 DİREKSİYON KÖRÜĞÜ SAĞ	Ağırlık : 0.1 kg / 0.220 lb	114509823, 4239459 4371156, 7583243
	FI13014 DİREKSİYON KÖRÜĞÜ SOL	Ağırlık : 0.062 kg / 0.137 lb	114509823, 4239459 4371156, 7583243 9939039
	SK14002 AKS KÖRÜĞÜ +KELEPÇE+YAĞ. İÇ YENİ MODEL	Ağırlık : 0.232 kg / 0.511 lb	115429823, 95 640 970 95640970
	SK14003 AKS KÖRÜĞÜ +KELEPÇE+YAĞ. İÇ ESKİ MODEL	Ağırlık : 0.2 kg / 0.441 lb	114429820

FAVORIT
PICK-UP 787
1992 - 1997

Resim	Ürün Kodu ve Açıklaması	Detay	OEM
	SK1022 ROTİL ALT SAĞ-SOL RC7511	Ağırlık : 0,42 kg / 0.926 lb Bağlantı Delik Çapı : Ø8,5	115420240, 6U0407365 6U0407807
	SK2002 ROTBAŞI SAĞ-SOL M12X1	Ağırlık : 0,316 kg / 0.697 lb Uzunluk : 79 mm / 3.11 inch Gövde Diş Çapı : M12X1 Aşık Diş Çapı : M12X1,25 Aşık Konik Çapı : Ø12,5	007350278P, 115500440 6U0422811
	SK3006 ROTMİLİ SAĞ-SOL RC7811	Ağırlık : 0.415 kg / 0.915 lb Uzunluk : 334 mm / 13.15 inch Aşık Diş Çapı : M12X1	115500420
	SK6001 SALINCAK ÖN ALT SAĞ RC8011	Ağırlık : 2,637 kg / 5.814 lb Malzeme Türü : Sac Metal	, 115420021 115420024
	SK6002 SALINCAK ÖN ALT SOL RC8012	Ağırlık : 2,636 kg / 5.811 lb Malzeme Türü : Sac Metal	115420020, 115420023

* Bu sayfada ve katalogdaki tüm araçların adları, markaları, modelleri, sembolleri, logoları, orjinal numaraları (oe) ve diğer üçüncü parti numaraları sadece referans amaçlı kullanılmaktadır.

FAVORIT
PICK-UP 787
1992 - 1997











Resim	Ürün Kodu ve Açıklaması	Detay	OEM
	SK6003 SALINCAK ÖN ALT SAĞ RC8015	Ağırlık : 2,7 kg / 5.952 lb Malzeme Türü : Sac Metal	115420024
	SK6004 SALINCAK ÖN ALT SOL RC8016	Ağırlık : 2,679 kg / 5.906 lb Malzeme Türü : Sac Metal	115420023
	SK11003 SALINCAK VE DENGE KOLU BURCU SOL VE SAĞ B37112	Yön : Sol Ve Sağ Ağırlık : 0,111 kg / 0.245 lb	115422291
	SK11004 SALINCAK VE DENGE KOLU BURCU SOL VE SAĞ B37114	Yön : Sol Ve Sağ Ağırlık : 0,24 kg / 0.529 lb	115422292
	SK11005 SALINCAK VE DENGE KOLU BURCU ÖN SOL VE SAĞ B37113	Şasi (Ön / Arka) : ÖN Yön : Sol Ve Sağ Ağırlık : 0,086 kg / 0.190 lb	115422290, 6U0407182
	FI13013 DİREKSİYON KÖRÜĞÜ SAĞ	Ağırlık : 0.1 kg / 0.220 lb	114509823, 4239459 4371156, 7583243
	FI13014 DİREKSİYON KÖRÜĞÜ SOL	Ağırlık : 0.062 kg / 0.137 lb	114509823, 4239459 4371156, 7583243 9939039
	SK14002 AKS KÖRÜĞÜ +KELEPÇE+YAĞ. İÇ YENİ MODEL	Ağırlık : 0.232 kg / 0.511 lb	115429823, 95 640 970 95640970
	SK14003 AKS KÖRÜĞÜ +KELEPÇE+YAĞ. İÇ ESKİ MODEL	Ağırlık : 0.2 kg / 0.441 lb	114429820

FELICIA
I PICK-UP 6UF, 6U7
1994 - 2001

Resim	Ürün Kodu ve Açıklaması	Detay	OEM
	SK1022 ROTİL ALT SAĞ-SOL RC7511	Ağırlık : 0,42 kg / 0.926 lb Bağlantı Delik Çapı : Ø8,5	115420240, 6U0407365 6U0407807



* Bu sayfada ve katalogdaki tüm araçların adları, markaları, modelleri, sembolleri, logoları, orjinal numaraları (oe) ve diğer üçüncü parti numaraları sadece referans amaçlı kullanılmaktadır.

FELICIA
I PICK-UP 6UF, 6U7
1994 - 2001

Resim	Ürün Kodu ve Açıklaması	Detay	OEM
	SK2002 ROTBAŞI SAĞ-SOL M12X1	Ağırlık : 0,316 kg / 0.697 lb Uzunluk : 79 mm / 3.11 inch Gövde Diş Çapı : M12X1 Aşık Diş Çapı : M12X1,25 Aşık Konik Çapı : Ø12,5	007350278P, 115500440 6U0422811
	SK3001 ROTMİLİ ÖN SAĞ - SOL 320	Ağırlık : 0,713 kg / 1.572 lb Uzunluk : 320 mm / 12.60 inch Gövde Diş Çapı : M14X1,5 Aşık Diş Çapı : M12X1	007350278N, 640422807 6U0422807
	SK3002 ROTMİLİ ÖN SAĞ - SOL 357	Ağırlık : 0,55 kg / 1.213 lb Uzunluk : 357 mm / 14.06 inch Gövde Diş Çapı : M14X1,5 Aşık Diş Çapı : M12X1	007350278N, 640422807 6U0422807
	SK6005 SALINCAK ÖN ALT SAĞ RC8013	Ağırlık : 3,005 kg / 6.625 lb Malzeme Türü : Sac Metal	7304446, 7304448
	SK6006 SALINCAK ÖN ALT SOL RC8014	Ağırlık : 3,103 kg / 6.841 lb Malzeme Türü : Sac Metal	6U0407151, 6U0407151A 7304447
	SK6007 SALINCAK ÖN ALT SAĞ RC8018	Ağırlık : 3,4 kg / 7.496 lb Malzeme Türü : Sac Metal	, 6U0407152 6U0407152B
	SK6008 SALINCAK ÖN ALT SOL RC8017	Ağırlık : 3,289 kg / 7.251 lb Malzeme Türü : Sac Metal	6U0407151, 6U0407151B
	SK11001 SALINCAK VE DENGE KOLU BURCU SAĞ B37116	Yön : Sağ Diğer Taraf : SK11002 Ağırlık : 0,592 kg / 1.305 lb	6U0407504, 7296377
	SK11002 SALINCAK VE DENGE KOLU BURCU SOL B37115	Yön : Sol Diğer Taraf : SK11001 Ağırlık : 0,614 kg / 1.354 lb	6U0407503, 7296379
	SK11005 SALINCAK VE DENGE KOLU BURCU ÖN SOL VE SAĞ B37113	Şasi (Ön / Arka) : ÖN Yön : Sol Ve Sağ Ağırlık : 0,086 kg / 0.190 lb	115422290, 6U0407182
	AU12012 EGSOZ TAKOZU ÖN SOL VE SAĞ EGSOZ LASTİĞİ	Şasi (Ön / Arka) : ÖN Yön : Sol Ve Sağ Ağırlık : 0.034 kg / 0.075 lb Not : EGSOZ LASTİĞİ	191253147B, 4A0253147A

* Bu sayfada ve katalogdaki tüm araçların adları, markaları, modelleri, sembolleri, logoları, orjinal numaraları (oe) ve diğer üçüncü parti numaraları sadece referans amaçlı kullanılmaktadır.

FELICIA I PICK-UP 6UF, 6U7 1994 - 2001









Resim	Ürün Kodu ve Açıklaması	Detay	OEM
	FI13013 DİREKSİYON KÖRÜĞÜ SAĞ	Ağırlık : 0.1 kg / 0.220 lb	114509823, 4239459 4371156, 7583243
	VW13007 DİREKSİYON KÖRÜĞÜ	Ağırlık : 0.128 kg / 0.282 lb	6N0422831
	SK14001 AKS KÖRÜĞÜ +KELEPÇE+YAĞ. DIŞ LÖBRO TİPİ	Ağırlık : 0.22 kg / 0.485 lb	640407311

FELICIA I-II 6U1 1994 - 2001

Resim	Ürün Kodu ve Açıklaması	Detay	OEM
	SK1022 ROTİL ALT SAĞ-SOL RC7511	Ağırlık : 0,42 kg / 0.926 lb Bağlantı Delik Çapı : Ø8,5	115420240, 6U0407365 6U0407807
	SK2002 ROTBAŞI SAĞ-SOL M12X1	Ağırlık : 0,316 kg / 0.697 lb Uzunluk : 79 mm / 3.11 inch Gövde Diş Çapı : M12X1 Aşık Diş Çapı : M12X1,25 Aşık Konik Çapı : Ø12,5	007350278P, 115500440 6U0422811
	SK3001 ROTMİLİ ÖN SAĞ - SOL 320	Ağırlık : 0,713 kg / 1.572 lb Uzunluk : 320 mm / 12.60 inch Gövde Diş Çapı : M14X1,5 Aşık Diş Çapı : M12X1	007350278N, 640422807 6U0422807
	SK3002 ROTMİLİ ÖN SAĞ - SOL 357	Ağırlık : 0,55 kg / 1.213 lb Uzunluk : 357 mm / 14.06 inch Gövde Diş Çapı : M14X1,5 Aşık Diş Çapı : M12X1	007350278N, 640422807 6U0422807
	SK6005 SALINCAK ÖN ALT SAĞ RC8013	Ağırlık : 3,005 kg / 6.625 lb Malzeme Türü : Sac Metal	7304446, 7304448
	SK6006 SALINCAK ÖN ALT SOL RC8014	Ağırlık : 3,103 kg / 6.841 lb Malzeme Türü : Sac Metal	6U0407151, 6U0407151A 7304447
	SK6007 SALINCAK ÖN ALT SAĞ RC8018	Ağırlık : 3,4 kg / 7.496 lb Malzeme Türü : Sac Metal	, 6U0407152 6U0407152B

* Bu sayfada ve katalogdaki tüm araçların adları, markaları, modelleri, sembolleri, logoları, orjinal numaraları (oe) ve diğer üçüncü parti numaraları sadece referans amaçlı kullanılmaktadır.

FELICIA
I-II 6U1
1994 - 2001











Resim	Ürün Kodu ve Açıklaması	Detay	OEM
	SK6008 SALINCAK ÖN ALT SOL RC8017	Ağırlık : 3,289 kg / 7.251 lb Malzeme Türü : Sac Metal	6U0407151, 6U0407151B
	SK11001 SALINCAK VE DENGE KOLU BURCU SAĞ B37116	Yön : Sağ Diğer Taraf : SK11002 Ağırlık : 0,592 kg / 1.305 lb	6U0407504, 7296377
	SK11002 SALINCAK VE DENGE KOLU BURCU SOL B37115	Yön : Sol Diğer Taraf : SK11001 Ağırlık : 0,614 kg / 1.354 lb	6U0407503, 7296379
	SK11005 SALINCAK VE DENGE KOLU BURCU ÖN SOL VE SAĞ B37113	Şasi (Ön / Arka) : ÖN Yön : Sol Ve Sağ Ağırlık : 0,086 kg / 0.190 lb	115422290, 6U0407182
	AU12012 EGSOZ TAKOZU ÖN SOL VE SAĞ EGSOZ LASTİĞİ	Şasi (Ön / Arka) : ÖN Yön : Sol Ve Sağ Ağırlık : 0.034 kg / 0.075 lb Not : EGSOZ LASTİĞİ	191253147B, 4A0253147A
	FI13013 DİREKSİYON KÖRÜĞÜ SAĞ	Ağırlık : 0.1 kg / 0.220 lb	114509823, 4239459 4371156, 7583243
	VW13007 DİREKSİYON KÖRÜĞÜ	Ağırlık : 0.128 kg / 0.282 lb	6N0422831
	SK14001 AKS KÖRÜĞÜ +KELEPÇE+YAĞ. DIŞ LÖBRO TİPİ	Ağırlık : 0.22 kg / 0.485 lb	640407311

FELICIA
I-II ESTATE 6U5
1994 - 2001

Resim	Ürün Kodu ve Açıklaması	Detay	OEM
	SK1022 ROTİL ALT SAĞ-SOL RC7511	Ağırlık : 0,42 kg / 0.926 lb Bağlantı Delik Çapı : Ø8,5	115420240, 6U0407365 6U0407807
	SK2002 ROTBAŞI SAĞ-SOL M12X1	Ağırlık : 0,316 kg / 0.697 lb Uzunluk : 79 mm / 3.11 inch Gövde Diş Çapı : M12X1 Aşık Diş Çapı : M12X1,25 Aşık Konik Çapı : Ø12,5	007350278P, 115500440 6U0422811

* Bu sayfada ve katalogdaki tüm araçların adları, markaları, modelleri, sembolleri, logoları, orjinal numaraları (oe) ve diğer üçüncü parti numaraları sadece referans amaçlı kullanılmaktadır.

FELICIA
I-II ESTATE 6U5
1994 - 2001

Resim	Ürün Kodu ve Açıklaması	Detay	OEM
	SK3001 ROTMİLİ ÖN SAĞ - SOL 320	Ağırlık : 0,713 kg / 1.572 lb Uzunluk : 320 mm / 12.60 inch Gövde Diş Çapı : M14X1,5 Aşık Diş Çapı : M12X1	007350278N, 640422807 6U0422807
	SK3002 ROTMİLİ ÖN SAĞ - SOL 357	Ağırlık : 0,55 kg / 1.213 lb Uzunluk : 357 mm / 14.06 inch Gövde Diş Çapı : M14X1,5 Aşık Diş Çapı : M12X1	007350278N, 640422807 6U0422807
	SK6005 SALINCAK ÖN ALT SAĞ RC8013	Ağırlık : 3,005 kg / 6.625 lb Malzeme Türü : Sac Metal	7304446, 7304448
	SK6006 SALINCAK ÖN ALT SOL RC8014	Ağırlık : 3,103 kg / 6.841 lb Malzeme Türü : Sac Metal	6U0407151, 6U0407151A 7304447
	SK6007 SALINCAK ÖN ALT SAĞ RC8018	Ağırlık : 3,4 kg / 7.496 lb Malzeme Türü : Sac Metal	, 6U0407152 6U0407152B
	SK6008 SALINCAK ÖN ALT SOL RC8017	Ağırlık : 3,289 kg / 7.251 lb Malzeme Türü : Sac Metal	6U0407151, 6U0407151B
	SK11001 SALINCAK VE DENG KOLU BURCU SAĞ B37116	Yön : Sağ Diğer Taraf : SK11002 Ağırlık : 0,592 kg / 1.305 lb	6U0407504, 7296377
	SK11002 SALINCAK VE DENG KOLU BURCU SOL B37115	Yön : Sol Diğer Taraf : SK11001 Ağırlık : 0,614 kg / 1.354 lb	6U0407503, 7296379
	SK11005 SALINCAK VE DENG KOLU BURCU ÖN SOL VE SAĞ B37113	Şasi (Ön / Arka) : ÖN Yön : Sol Ve Sağ Ağırlık : 0,086 kg / 0.190 lb	115422290, 6U0407182
	AU12012 EGSOZ TAKOZU ÖN SOL VE SAĞ EGSOZ LASTİĞİ	Şasi (Ön / Arka) : ÖN Yön : Sol Ve Sağ Ağırlık : 0.034 kg / 0.075 lb Not : EGSOZ LASTİĞİ	191253147B, 4A0253147A
	F113013 DİREKSİYON KÖRÜĞÜ SAĞ	Ağırlık : 0.1 kg / 0.220 lb	114509823, 4239459 4371156, 7583243

* Bu sayfada ve katalogdaki tüm araçların adları, markaları, modelleri, sembolleri, logoları, orjinal numaraları (oe) ve diğer üçüncü parti numaraları sadece referans amaçlı kullanılmaktadır.







FELICIA
I-II ESTATE 6U5
1994 - 2001

Resim	Ürün Kodu ve Açıklaması	Detay	OEM
	VW13007 DİREKSİYON KÖRÜĞÜ	Ağırlık : 0.128 kg / 0.282 lb	6N0422831
	SK14001 AKS KÖRÜĞÜ +KELEPÇE+YAĞ. DIŞ LÖBRO TİPİ	Ağırlık : 0.22 kg / 0.485 lb	640407311

KAMIQ
2019 -

Resim	Ürün Kodu ve Açıklaması	Detay	OEM
	SK12005 MOTOR TAKOZU ÖN SAĞ	Şasi (Ön / Arka) : ÖN Yön : Sağ Ağırlık : 1,575 kg / 3.472 lb	5Q0199262CK

KAROQ
NU7
2017 -



Resim	Ürün Kodu ve Açıklaması	Detay	OEM
	VW2008 ROTBAŞI ÖN SAĞ RD0342	Ağırlık : 0,412 kg / 0.908 lb Uzunluk : 95 mm / 3.74 inch Gövde Diş Çapı : M16X1,5 Aşık Diş Çapı : M12X1,5 Aşık Konik Çapı : Ø12,7	1K0423812A, 1K0423812C 1K0423812E, 1K0423812G 1K0423812J, 1K0423812K 1KD423812A
	VW2009 ROTBAŞI ÖN SOL RD0343	Ağırlık : 0,412 kg / 0.908 lb Uzunluk : 95 mm / 3.74 inch Gövde Diş Çapı : M16X1,5 Aşık Diş Çapı : M12X1,5 Aşık Konik Çapı : Ø13,5	1K0423811A, 1K0423811C 1K0423811E, 1K0423811G 1K0423811J, 1K0423811K 1KD423811A
	VW20083021 ROT TAKIMI ÖN AKS SAĞ	Ağırlık : 1,2 kg / 2.646 lb Rotbaşı : VW2008 Rotmili : VW3021	561423810, 561423810S1
	VW20093021 ROT TAKIMI ÖN SOL	Ağırlık : 1,2 kg / 2.646 lb Rotbaşı : VW2009 Rotmili : VW3021	561423810 S2, 561423810
	AU9009 SALINCAK ALT SOL VE SAĞ	Ağırlık : 2,910 kg / 6.415 lb Malzeme Türü : Sac Metal	5Q0505311C, 5Q0505311D
	AU9012 SALINCAK ARKA ALT SAĞ	Ağırlık : 1,640 kg / 3.616 lb Malzeme Türü : Sac Metal	5Q0505224D

* Bu sayfada ve katalogdaki tüm araçların adları, markaları, modelleri, sembolleri, logoları, orjinal numaraları (oe) ve diğer üçüncü parti numaraları sadece referans amaçlı kullanılmaktadır.

KAROQ
NU7
2017 -











Resim	Ürün Kodu ve Açıklaması	Detay	OEM
	AU9013 SALINCAK ARKA ALT SOL	Ağırlık : 1,640 kg / 3.616 lb Malzeme Türü : Sac Metal	5Q0505223D
	VW6055 SALINCAK ÖN ALT SAĞ	Ağırlık : 3,768 kg / 8.307 lb Malzeme Türü : Sac Metal	3Q0407152E*, 3Q0407152E 3Q0407152F*, 3Q0407152F 3Q0407154B*, 3Q0407154B
	VW6055J SALINCAK ÖN ALT SAĞ	Malzeme Türü : Sac Metal	3Q0407152E, 3Q0407152F 3Q0407154B
	VW6056 SALINCAK ÖN ALT SOL	Ağırlık : 3,768 kg / 8.307 lb Malzeme Türü : Sac Metal	3Q0407151E*, 3Q0407151E 3Q0407151F*, 3Q0407151F 3Q0407153B*, 3Q0407153B
	VW6056J SALINCAK ÖN ALT SOL	Malzeme Türü : Sac Metal	3Q0407151E, 3Q0407151F 3Q0407153B
	AU11068 SALINCAK VE DENG KOLU BURCU ARKA ALT SOL VE SAĞ METAL	Şasi (Ön / Arka) : ARKA Yön : Alt Sol Ve Sağ Ağırlık : 0,201 kg / 0.443 lb Malzeme Türü : Metal	PART OF 5Q0505223D, PART OF 5Q0505224D
	AU11070 SALINCAK VE DENG KOLU BURCU ARKA ALT	Şasi (Ön / Arka) : ARKA Yön : Alt Ağırlık : 0,100 kg / 0.220 lb	5Q0505171, 5Q0505311C 5Q0505311CSK, 5Q0505311D 5Q0505311DSK
	AU12022 MOTOR TAKOZU SOL VE SAĞ MOTOR TAKOZU	Yön : Sol Ve Sağ Ağırlık : 1.58 kg / 3.483 lb Malzeme Türü : Motor TakoZu	5Q0199262, 5Q0199262BH 5Q0199262DE
	AU12026 MOTOR TAKOZU ÖN SOL VE SAĞ	Şasi (Ön / Arka) : ÖN Yön : Sol Ve Sağ Ağırlık : 0,850 kg / 1.874 lb	5Q0199855AD, 5Q0199855J 5Q0199855P, 5Q0199855Q
	SK12005 MOTOR TAKOZU ÖN SAĞ	Şasi (Ön / Arka) : ÖN Yön : Sağ Ağırlık : 1,575 kg / 3.472 lb	5Q0199262CK

KODIAQ
NS7
2016 -

Resim	Ürün Kodu ve Açıklaması	Detay	OEM
	VW1019 ROTİL ÖN SAĞ Ø15,3 RB2538	Ağırlık : 0,555 kg / 1.224 lb Konik Ölçüsü : Ø15,3 Bağlantı Delik Çapı : Ø10,5 Aşık Diş Çapı : M12X1,5	3C0407366A
	VW1020 ROTİL ÖN SOL Ø15,3 RB2539	Ağırlık : 0,555 kg / 1.224 lb Konik Ölçüsü : Ø15,3 Bağlantı Delik Çapı : Ø10,5 Aşık Diş Çapı : M12X1,5	3C0407365A
	VW2008 ROTBAŞI ÖN SAĞ RD0342	Ağırlık : 0,412 kg / 0.908 lb Uzunluk : 95 mm / 3.74 inch Gövde Diş Çapı : M16X1,5 Aşık Diş Çapı : M12X1,5 Aşık Konik Çapı : Ø12,7	1K0423812A, 1K0423812C 1K0423812E, 1K0423812G 1K0423812J, 1K0423812K 1KD423812A
	VW2009 ROTBAŞI ÖN SOL RD0343	Ağırlık : 0,412 kg / 0.908 lb Uzunluk : 95 mm / 3.74 inch Gövde Diş Çapı : M16X1,5 Aşık Diş Çapı : M12X1,5 Aşık Konik Çapı : Ø13,5	1K0423811A, 1K0423811C 1K0423811E, 1K0423811G 1K0423811J, 1K0423811K 1KD423811A
	VW3021 ROTMİLİ SAĞ-SOL	Ağırlık : 0,705 kg / 1.554 lb Uzunluk : 330 mm / 12.99 inch	561423810
	VW20083021 ROT TAKIMI ÖN AKS SAĞ	Ağırlık : 1,2 kg / 2.646 lb Rotbaşı : VW2008 Rotmili : VW3021	561423810, 561423810S1
	VW20093021 ROT TAKIMI ÖN SOL	Ağırlık : 1,2 kg / 2.646 lb Rotbaşı : VW2009 Rotmili : VW3021	561423810 S2, 561423810
	VW4014 Z ROT ÖN SAĞ-SOL METAL 335 RB2935	Ağırlık : 0,46 kg / 1.014 lb Malzeme Türü : Metal Uzunluk : 335 mm / 13.19 inch Aşık Diş Çapı : M12X1,5	1K0411315B, 1K0411315D 1K0411315J, 1K0411315K 1K0411315R, 5Q0411315A 5Q0411315B
	SK9002 SALINCAK ALT SOL VE SAĞ	Ağırlık : 2,914 kg / 6.424 lb Malzeme Türü : Sac Metal	3Q0505311C, 3Q0505311D 3Q0505311E
	VW6055 SALINCAK ÖN ALT SAĞ	Ağırlık : 3,768 kg / 8.307 lb Malzeme Türü : Sac Metal	3Q0407152E*, 3Q0407152E 3Q0407152F*, 3Q0407152F 3Q0407154B*, 3Q0407154B
	VW6055J SALINCAK ÖN ALT SAĞ	Malzeme Türü : Sac Metal	3Q0407152E, 3Q0407152F 3Q0407154B

* Bu sayfada ve katalogdaki tüm araçların adları, markaları, modelleri, sembolleri, logoları, orijinal numaraları (oe) ve diğer üçüncü parti numaraları sadece referans amaçlı kullanılmaktadır.

KODIAQ
NS7
2016 -

Resim	Ürün Kodu ve Açıklaması	Detay	OEM
	VW6056 SALINCAK ÖN ALT SOL	Ağırlık : 3,768 kg / 8.307 lb Malzeme Türü : Sac Metal	3Q0407151E*, 3Q0407151E 3Q0407151F*, 3Q0407151F 3Q0407153B*, 3Q0407153B
	VW6056J SALINCAK ÖN ALT SOL	Malzeme Türü : Sac Metal	3Q0407151E, 3Q0407151F 3Q0407153B
	VW9005 SALINCAK ARKA ALT ÖNDEN	Ağırlık : 0,566 kg / 1.248 lb Malzeme Türü : Sac Metal	5Q0501529C, 5Q0501529D 5Q0501529E, 5Q0501529F
	VW9008 SALINCAK SAĞ	Ağırlık : 1,110 kg / 2.447 lb Malzeme Türü : Sac Metal	5QF505224C
	VW9009 SALINCAK SOL	Ağırlık : 1,110 kg / 2.447 lb Malzeme Türü : Sac Metal	5QF505223C
	SK11006 SALINCAK VE DENGE KOLU BURCU ARKA ALT	Şasi (Ön / Arka) : ARKA Yön : Alt Ağırlık : 0,125 kg / 0.276 lb	3Q0505311C*, 3Q0505311D* 3Q0505311E*, 5Q0505171B*
	VW11042 SALINCAK VE DENGE KOLU BURCU ORTA SOL VE SAĞ	Yön : Orta Sol Ve Sağ Ağırlık : 0,182 kg / 0.401 lb	1K0407182, 5Q0407182
	VW11063 SALINCAK VE DENGE KOLU BURCU SOL VE SAĞ	Yön : Sol Ve Sağ Ağırlık : 0.34 kg / 0.750 lb	5Q0407183D, 5Q0407183E
	VW11075 SALINCAK VE DENGE KOLU BURCU ARKA SOL VE SAĞ	Şasi (Ön / Arka) : ARKA Yön : Sol Ve Sağ Ağırlık : 0,870 kg / 1.918 lb Not : FORWARD and INNER	Part of 5Q0501529C, Part of 5Q0501529D Part of 5Q0501529E, Part of 5Q0501529F
	VW11076 SALINCAK VE DENGE KOLU BURCU ARKA SOL VE SAĞ	Şasi (Ön / Arka) : ARKA Yön : Sol Ve Sağ Ağırlık : 0,870 kg / 1.918 lb Not : FORWARD and OUTER	Part of 5Q0501529C, Part of 5Q0501529D Part of 5Q0501529E, Part of 5Q0501529F
	AU12023 MOTOR TAKOZU SOL VE SAĞ MOTOR TAKOZU 7 İLERİ	Yön : Sol Ve Sağ Ağırlık : 1.58 kg / 3.483 lb Malzeme Türü : Motor Takozu Not : 7 İLERİ	5Q0199262BE, 5Q0199262BF

* Bu sayfada ve katalogdaki tüm araçların adları, markaları, modelleri, sembolleri, logoları, orijinal numaraları (oe) ve diğer üçüncü parti numaraları sadece referans amaçlı kullanılmaktadır.

KODIAQ
NS7
2016 -



Resim	Ürün Kodu ve Açıklaması	Detay	OEM
	AU12026 MOTOR TAKOZU ÖN SOL VE SAĞ	Şasi (Ön / Arka) : ÖN Yön : Sol Ve Sağ Ağırlık : 0,850 kg / 1.874 lb	5Q0199855AD, 5Q0199855J 5Q0199855P, 5Q0199855Q

OCTAVIA
I 1U2
1996 - 2004

Resim	Ürün Kodu ve Açıklaması	Detay	OEM
	AU1014 ROTİL ALT SAĞ Ø15	Ağırlık : 0,35 kg / 0.772 lb Konik Ölçüsü : Ø15 Bağlantı Delik Çapı : Ø8,5 Aşık Diş Çapı : M12X1,25	1J0407366A, 1J0407366AS 1J0407366B, 1J0407366C 1J0407366D, 1J0407366H
	AU1014K ROTİL ÖN SAĞ Ø15 RB2530	Ağırlık : 0,5 kg / 1.102 lb Konik Ölçüsü : Ø15 Bağlantı Delik Çapı : Ø8,5 Aşık Diş Çapı : M12X1,25	1J0407366, 1J0407366A 1J0407366AS, 1J0407366B 1J0407366C, 1J0407366CS 1J0407366D*, 1J0407366D 1J0407366H, 8Z0407366A
	AU1015 ROTİL SOL	Ağırlık : 0,35 kg / 0.772 lb Konik Ölçüsü : Ø15 Bağlantı Delik Çapı : Ø8,5 Aşık Diş Çapı : M12X1,25	1J0407365A, 1J0407365B 1J0407365C, 1J0407365D
	AU1015K ROTİL ÖN SOL Ø15 RB2529	Ağırlık : 0,5 kg / 1.102 lb Konik Ölçüsü : Ø15 Bağlantı Delik Çapı : Ø8,5 Aşık Diş Çapı : M12X1,25	1J0407365, 1J0407365A* 1J0407365A, 1J0407365AS 1J0407365B*, 1J0407365B 1J0407365C*, 1J0407365C 1J0407365CS, 1J0407365D*
	AU2009 ROTBAŞI SAĞ UZUN RD0332	Ağırlık : 0,37 kg / 0.816 lb Uzunluk : 92 mm / 3.62 inch Gövde Diş Çapı : M14X1,5 Aşık Diş Çapı : M12X1,5 Aşık Konik Çapı : Ø13,3	1J0422812B, 3A0422812B 6R0423812A
	AU2010 ROTBAŞI SOL RD0331	Ağırlık : 0,375 kg / 0.827 lb Uzunluk : 92 mm / 3.62 inch Gövde Diş Çapı : M14X1,5 Aşık Diş Çapı : M12X1,5 Aşık Konik Çapı : Ø13,2	1J0422811B, 1JD422811 3A0422811B, 6R0423811A
	AU2318 ROTBAŞI SOL KISA RB2318	Ağırlık : 0,312 kg / 0.688 lb Uzunluk : 76 mm / 2.99 inch Gövde Diş Çapı : M14X1,5 Aşık Diş Çapı : M12X1,5 Aşık Konik Çapı : Ø13,4	1J0422811, 1J0422811A
	AU2319 ROTBAŞI SAĞ KISA RB2319	Ağırlık : 0,315 kg / 0.694 lb Uzunluk : 76 mm / 2.99 inch Gövde Diş Çapı : M14X1,5 Aşık Diş Çapı : M12X1,5 Aşık Konik Çapı : Ø13,4	1J0422812, 1J0422812A
	AU3001 ROTMİLİ SOL VE SAĞ 318 RD0908	Ağırlık : 0,622 kg / 1.371 lb Uzunluk : 318 mm / 12.52 inch Gövde Diş Çapı : M16X1,5 Aşık Diş Çapı : M14X1,5	1J0422803B, 1J0422804B 1J0422804E, 1J0422807 1J0422807B, 1J0422821B

* Bu sayfada ve katalogdaki tüm araçların adları, markaları, modelleri, sembolleri, logoları, orjinal numaraları (oe) ve diğer üçüncü parti numaraları sadece referans amaçlı kullanılmaktadır.

OCTAVIA**I 1U2****1996 - 2004**

Resim	Ürün Kodu ve Açıklaması	Detay	OEM
	AU3003 ROTMİLİ SAĞ-SOL UZUN L 360 MM RB2811	Ağırlık : 0,629 kg / 1.387 lb Uzunluk : 341 mm / 13.43 inch Gövde Diş Çapı : M16X1,5 Aşık Diş Çapı : M14X1,5	1J0422803A, 1J0422804A 1J0422807A, 1J0422807C 1J0422821, 1J0422821A 1J0822807B
	AU3004 ROTMİLİ	Ağırlık : 0.35 kg / 0.772 lb Uzunluk : 320 mm / 12.60 inch	1J0422810B

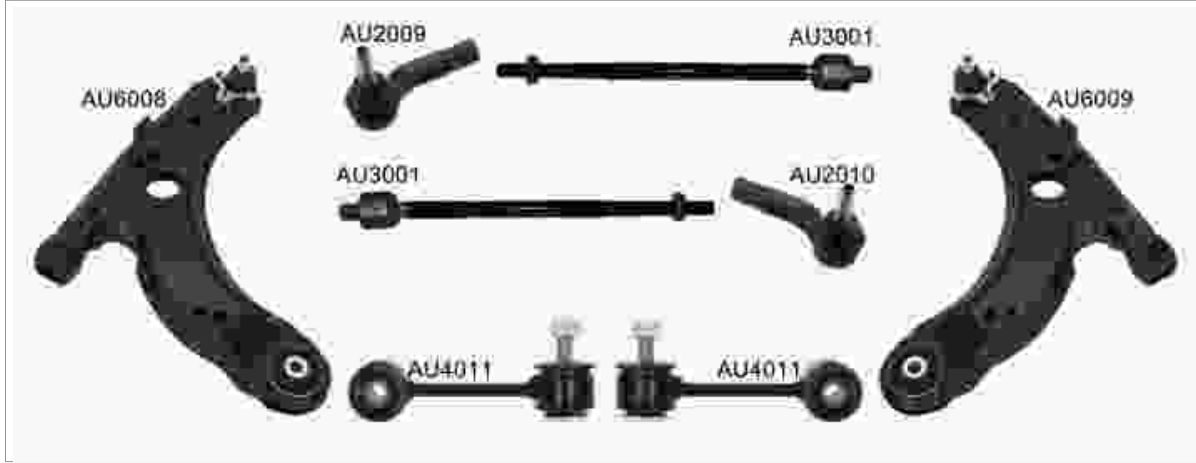
VW8001 / Süspansiyon Kit Ön
OCTAVIA
I 1U2
1996 - 2004

Kit Parçaları











Resim	Ürün Kodu / Adı	OEM	OEM	Ürün Kodu / Adı	Resim
	AU2009 Rotbaşı Sağ Uzun Rd0332	1J0422812B, 3A0422812B 6R0423812A	1J0422811B, 1JD422811 3A0422811B, 6R0423811A	AU2010 Rotbaşı Sol Rd0331	
	AU3001 Rotmili Sol Ve Sağ 318 Rd0908	1J0422803B, 1J0422804B 1J0422804E, 1J0422807 1J0422807B, 1J0422821B	1J0411315E, 1J0411315G 1J0422315G	VW4011 Z Rot Ön Sağ-sol Metal 105 Rd0916	
	AU6008 Salıncak Ön Sağ Rb3011	1J0407151B	1J0407151A	AU6009 Salıncak Ön Sol Rb3012	

OCTAVIA
I 1U2
1996 - 2004

Resim	Ürün Kodu ve Açıklaması	Detay	OEM
	AU20093001 ROT TAKIMI SAĞ	Ağırlık : 0,951 kg / 2.097 lb Rotbaşı : AU2009 Rotmili : AU3001	1H0422804B
	AU20103001 ROT TAKIMI SOL	Ağırlık : 0,952 kg / 2.099 lb Rotbaşı : AU2010 Rotmili : AU3001	1H0422803B
	AU23183003 ROT TAKIMI SAĞ RB288113	Ağırlık : 0,945 kg / 2.083 lb Rotbaşı : AU2318 Rotmili : AU3003	1J0422804, 1J0422804A 1J0422804C
	AU23183004 ROT TAKIMI SOL RD088206	Ağırlık : 1,075 kg / 2.370 lb Rotbaşı : AU2318 Rotmili : AU3004	1J0422803B
	AU23193003 ROT TAKIMI SOL RB288112	Ağırlık : 0,94 kg / 2.072 lb Rotbaşı : AU2319 Rotmili : AU3003	1J0422803, 1J0422803A 1J0422803C
	AU23193004 ROT TAKIMI SAĞ RD088207	Ağırlık : 1,1 kg / 2.425 lb Rotbaşı : AU2319 Rotmili : AU3004	1J0422804B
	VW4010 Z ROT SOL VE SAĞ PLASTİK RD0924	Ağırlık : 0,18 kg / 0.397 lb Malzeme Türü : Plastik Uzunluk : 106 mm / 4.17 inch Aşık Diş Çapı : M10X1,5	1J0411315C, 1J0411315J
	VW4011 Z ROT ÖN SAĞ-SOL METAL 105 RD0916	Ağırlık : 0,258 kg / 0.569 lb Malzeme Türü : Metal Uzunluk : 106 mm / 4.17 inch Aşık Diş Çapı : M10X1,5	1J0411315E, 1J0411315G 1J0422315G
	VW4020 Z ROT ÖN SAĞ-SOL PLASTİK 105,5	Ağırlık : 0,151 kg / 0.333 lb Malzeme Türü : Plastik Uzunluk : 105 mm / 4.13 inch	1J0411315B, 1J0411315H 1J0411315K
	AU6008 SALINCAK ÖN SAĞ RB3011	Ağırlık : 3,495 kg / 7.705 lb Malzeme Türü : Sac Metal	1J0407151B
	AU6008J SALINCAK ÖN SAĞ RB3101	Ağırlık : 3,212 kg / 7.081 lb Malzeme Türü : Sac Metal	1J0407151C

* Bu sayfada ve katalogdaki tüm araçların adları, markaları, modelleri, sembolleri, logoları, orijinal numaraları (oe) ve diğer üçüncü parti numaraları sadece referans amaçlı kullanılmaktadır.

OCTAVIA
I 1U2
1996 - 2004

Resim	Ürün Kodu ve Açıklaması	Detay	OEM
	AU6009 SALINCAK ÖN SOL RB3012	Ağırlık : 3,495 kg / 7.705 lb Malzeme Türü : Sac Metal	1J0407151A
	AU11002 SALINCAK VE DENGE KOLU BURCU ÖN SOL VE SAĞ B22117	Şasi (Ön / Arka) : ÖN Yön : Sol Ve Sağ Ağırlık : 0,108 kg / 0.238 lb	1J0407181, 1J0407181A
	AU11005 SALINCAK VE DENGE KOLU BURCU ÖN ORTA SOL VE SAĞ B40115	Şasi (Ön / Arka) : ÖN Yön : Orta Sol Ve Sağ Ağırlık : 0,111 kg / 0.245 lb Not : VW6014 - VW60614J	191407182, 357407182 357407182F
	VW11036 SALINCAK VE DENGE KOLU BURCU SOL VE SAĞ	Yön : Sol Ve Sağ Ağırlık : 0.07 kg / 0.154 lb Not : BORUSU	191411315B, 4A0399413A
	VW11090 Z-ROT BURCU ÖN	Şasi (Ön / Arka) : ÖN Ağırlık : 0,045 kg / 0.099 lb	1J0411315*, 1J0411315B* 1J0411315C*, 1J0411315E* 1J0411315G*, 1J0411315J*
	VW11008 TAŞIYICI DESTEK BURÇLARI SOL VE SAĞ	Yön : Sol Ve Sağ Ağırlık : 0.24 kg / 0.529 lb	1J0505203, 1J0505365D 1J0505365F, 1J0505365G 1J0505365J, 1J0505365K 1J0505365M, 1J0505365N
	SK11011 TORSİYON BURCU SOL VE SAĞ	Yön : Sol Ve Sağ Ağırlık : 0,346 kg / 0.763 lb	6R0501541A
	VW12016 VİRAJ DEMİR LASTİĞİ SOL VE SAĞ RUBBER	Şasi (Ön / Arka) : ÖN Yön : Sol Ve Sağ Ağırlık : 0.03 kg / 0.066 lb Malzeme Türü : Rubber	1J0411314G, 1J0411314T 8N0411303G, 8N0411303H
	VW12016K VİRAJ DEMİR LASTİĞİ SOL VE SAĞ RUBBER	Şasi (Ön / Arka) : ÖN Yön : Sol Ve Sağ Ağırlık : 0.06 kg / 0.132 lb Malzeme Türü : Rubber Not : İKİLİ	1J0411314G, 1J0411314T 8N0411303G, 8N0411303H
	VW12020 VİRAJ DEMİR LASTİĞİ SOL VE SAĞ RUBBER	Şasi (Ön / Arka) : ÖN Yön : Sol Ve Sağ Ağırlık : 0.07 kg / 0.154 lb Malzeme Türü : Rubber Not : VİRAJ ORTA LASTİĞİ	8D0511327C
	VW12020K VİRAJ DEMİR LASTİĞİ SOL VE SAĞ RUBBER	Şasi (Ön / Arka) : ÖN Yön : Sol Ve Sağ Ağırlık : 0.14 kg / 0.309 lb Malzeme Türü : Rubber	8D0511327C*

* Bu sayfada ve katalogdaki tüm araçların adları, markaları, modelleri, sembolleri, logoları, orijinal numaraları (oe) ve diğer üçüncü parti numaraları sadece referans amaçlı kullanılmaktadır.

OCTAVIA
I 1U2
1996 - 2004

Resim	Ürün Kodu ve Açıklaması	Detay	OEM
	VW12047 VİRAJ DEMİR LASTİĞİ SOL VE SAĞ RUBBER	Şasi (Ön / Arka) : ÖN Yön : Sol Ve Sağ Ağırlık : 0.14 kg / 0.309 lb Malzeme Türü : Rubber Not : VİRAJ LASTİĞİ	1J0411314B, 1J0411314S
	VW12047K VİRAJ DEMİR LASTİĞİ SOL VE SAĞ RUBBER	Şasi (Ön / Arka) : ÖN Yön : Sol Ve Sağ Ağırlık : 0.28 kg / 0.617 lb Malzeme Türü : Rubber Not : VİRAJ LASTİĞİ (2 ADET)	1J0411314B*, 1J0411314B 1J0411314S*, 1J0411314S
	VW12048 VİRAJ DEMİR LASTİĞİ SOL VE SAĞ RUBBER	Şasi (Ön / Arka) : ÖN Yön : Sol Ve Sağ Ağırlık : 0.03 kg / 0.066 lb Malzeme Türü : Rubber Not : VİRAJ LASTİĞİ	1J0411314P
	VW12048K VİRAJ DEMİR LASTİĞİ SOL VE SAĞ RUBBER	Şasi (Ön / Arka) : ÖN Yön : Sol Ve Sağ Ağırlık : 0.06 kg / 0.132 lb Malzeme Türü : Rubber	1J0411314P*
	VW12052 VİRAJ DEMİR LASTİĞİ SOL VE SAĞ RUBBER	Şasi (Ön / Arka) : ÖN Yön : Sol Ve Sağ Ağırlık : 0.06 kg / 0.132 lb Malzeme Türü : Rubber Not : VİRAJ LASTİĞİ	1J0411314R
	VW12052K VİRAJ DEMİR LASTİĞİ SOL VE SAĞ RUBBER	Şasi (Ön / Arka) : ÖN Yön : Sol Ve Sağ Ağırlık : 0.12 kg / 0.265 lb Malzeme Türü : Rubber	1J0411314R*
	VW12064 VİRAJ DEMİR LASTİĞİ SOL VE SAĞ RUBBER	Şasi (Ön / Arka) : ÖN Yön : Sol Ve Sağ Ağırlık : 0,023 kg / 0.051 lb Malzeme Türü : Rubber Not : D=Ø21mm	1J0411314C, 1J0411314R
	VW12064K VİRAJ DEMİR LASTİĞİ SOL VE SAĞ RUBBER	Şasi (Ön / Arka) : ÖN Yön : Sol Ve Sağ Ağırlık : 0.046 kg / 0.101 lb Malzeme Türü : Rubber	1J0411314C*
	VW12117 VİRAJ DEMİR LASTİĞİ SOL VE SAĞ RUBBER	Şasi (Ön / Arka) : ÖN Yön : Sol Ve Sağ Ağırlık : 0.08 kg / 0.176 lb Malzeme Türü : Rubber	1J0411327
	VW12117K VİRAJ DEMİR LASTİĞİ SOL VE SAĞ RUBBER	Şasi (Ön / Arka) : ÖN Yön : Sol Ve Sağ Ağırlık : 0.16 kg / 0.353 lb Malzeme Türü : Rubber	1J0411327
	SK12002 AMORTİSÖR TAKOZU ARKA SOL VE SAĞ 1.2 / 1.4TSI / 1.6TDI / 1.2TDI	Şasi (Ön / Arka) : ARKA Yön : Sol Ve Sağ Ağırlık : 0,305 kg / 0.672 lb Not : 1.2 / 1.4TSI / 1.6TDI / 1.2TDI	1J0513353A, 1J0513353B 1J0513353C, 1J0513353G 6QE513353, 6R0513353 6R0513353B



* Bu sayfada ve katalogdaki tüm araçların adları, markaları, modelleri, sembolleri, logoları, orjinal numaraları (oe) ve diğer üçüncü parti numaraları sadece referans amaçlı kullanılmaktadır.

OCTAVIA
I 1U2
1996 - 2004

Resim	Ürün Kodu ve Açıklaması	Detay	OEM
	VW12061 AMORTİSÖR TAKOZU SOL VE SAĞ AMORTİSÖR TAKOZU	Yön : Sol Ve Sağ Ağırlık : 0.27 kg / 0.595 lb Not : AMORTİSÖR TAKOZU	1H0412365A, 1J0412249 1J0412331BS, 1J0412331C
	VW12061A AMORTİSÖR TAKOZU SOL VE SAĞ AMORTİSOR RULMANI	Yön : Sol Ve Sağ Ağırlık : 0.08 kg / 0.176 lb Not : AMORTİSOR RULMANI	1J0412249, 1J0412249C 357412249, 357412249A 4503300051, 7201688 7201848, 95VW3K031AA
	VW12061K AMORTİSÖR TAKOZU SOL VE SAĞ 2 PCS	Yön : Sol Ve Sağ Ağırlık : 0.7 kg / 1.543 lb Not : 2 PCS	1H0412365A, 1J0412249 1J0412331BS, 1J0412331C
	VW12103 AMORTİSÖR TAKOZU SOL VE SAĞ AMORTİSÖR ÜST TAKOZU	Yön : Sol Ve Sağ Ağırlık : 0.23 kg / 0.507 lb Not : AMORTİSÖR ÜST TAKOZU	1J0412331B, 1J0412331C
	VW12040 MOTOR TAKOZU SOL VE SAĞ MOTOR TAKOZU	Yön : Sol Ve Sağ Ağırlık : 1.641 kg / 3.618 lb Not : MOTOR TAKOZU	1J0199555AA, 1J0199555AK
	VW12070 MOTOR TAKOZU SOL VE SAĞ MOTOR TAKOZU	Yön : Sol Ve Sağ Ağırlık : 1.64 kg / 3.616 lb Not : MOTOR TAKOZU	1J0199555AH
	VW12073 MOTOR TAKOZU SOL VE SAĞ MOTOR TAKOZU	Yön : Sol Ve Sağ Ağırlık : 1.643 kg / 3.622 lb Not : MOTOR TAKOZU	1K0199262AC, 1K0199262AL 1K0199262L
	VW12075 MOTOR TAKOZU SOL VE SAĞ MOTOR TAKOZU	Yön : Sol Ve Sağ Ağırlık : 2.2 kg / 4.850 lb Not : MOTOR TAKOZU	1J0199262BF
	VW12081 MOTOR TAKOZU SOL VE SAĞ MOTOR TAKOZU	Yön : Sol Ve Sağ Ağırlık : 2.04 kg / 4.497 lb Not : MOTOR TAKOZU	1J0199262BK
	VW12084 MOTOR TAKOZU SOL VE SAĞ MOTOR TAKOZU	Yön : Sol Ve Sağ Ağırlık : 2.034 kg / 4.484 lb Not : MOTOR TAKOZU	1J0199262BE
	VW12085 MOTOR TAKOZU SOL VE SAĞ EGZOS TAKOZU	Yön : Sol Ve Sağ Ağırlık : 0.1 kg / 0.220 lb Not : EGZOS TAKOZU	1J0253144G, 1J0802117

* Bu sayfada ve katalogdaki tüm araçların adları, markaları, modelleri, sembolleri, logoları, orijinal numaraları (oe) ve diğer üçüncü parti numaraları sadece referans amaçlı kullanılmaktadır.

OCTAVIA
I 1U2
1996 - 2004

Resim	Ürün Kodu ve Açıklaması	Detay	OEM
	VW12100 MOTOR TAKOZU SOL VE SAĞ MOTOR TAKOZU ARKA	Yön : Sol Ve Sağ Ağırlık : 1.12 kg / 2.469 lb Not : MOTOR TAKOZU ARKA	1J0199851AA, 1J0199851AK 1J0199851M, 1J0199851N
	VW12102 MOTOR TAKOZU SOL VE SAĞ MOTOR TAKOZU	Yön : Sol Ve Sağ Ağırlık : 1.64 kg / 3.616 lb Not : MOTOR TAKOZU	1J0199555AJ, 1J0199555AM 1J0199555AQ, 1J0199555BH
	VW12096 SÜSPANSİYON TAKOZU SOL VE SAĞ SÜSPANSİYON TAKOZU	Yön : Sol Ve Sağ Ağırlık : 0.035 kg / 0.077 lb Not : SÜSPANSİYON TAKOZU	1J0412303
	VW13002 RIW DİREKSİYON KÖRÜĞÜ	Ağırlık : 0.1 kg / 0.220 lb	1J0422831, 1J0422831B 8N0422831
	VW13002K DİREKSİYON KÖRÜĞÜ SOL VE SAĞ 2 PİECES	Ağırlık : 0.2 kg / 0.441 lb	1J0422831, 1J0422831B 8N0422831
	VW13006 DİREKSİYON KÖRÜĞÜ	Ağırlık : 0.145 kg / 0.320 lb	1K0423831A, 5C0423831
	VW13006K DİREKSİYON KÖRÜĞÜ SOL VE SAĞ 2 PİECES	Ağırlık : 0.29 kg / 0.639 lb	1K0423831A, 5C0423831
	F114014 AKS KÖRÜĞÜ +KELEPÇE+YAĞ. DIŞ	Ağırlık : 0.211 kg / 0.465 lb	46307841
	VW14003 AKS KÖRÜĞÜ +KELEPÇE+YAĞ. DIŞ	Ağırlık : 0.25 kg / 0.551 lb	1K0 498 203, 1K0498203
	VW15002 AMORTİSÖR KÖRÜĞÜ ARKA	Şasi (Ön / Arka) : ARKA	900064

OCTAVIA
I COMBI 1U5
1996 - 2004

Resim	Ürün Kodu ve Açıklaması	Detay	OEM
	AU1014 ROTİL ALT SAĞ Ø15	Ağırlık : 0,35 kg / 0.772 lb Konik Ölçüsü : Ø15 Bağlantı Delik Çapı : Ø8,5 Aşık Diş Çapı : M12X1,25	1J0407366A, 1J0407366AS 1J0407366B, 1J0407366C 1J0407366D, 1J0407366H
	AU1014K ROTİL ÖN SAĞ Ø15 RB2530	Ağırlık : 0,5 kg / 1.102 lb Konik Ölçüsü : Ø15 Bağlantı Delik Çapı : Ø8,5 Aşık Diş Çapı : M12X1,25	1J0407366, 1J0407366A 1J0407366AS, 1J0407366B 1J0407366C, 1J0407366CS 1J0407366D*, 1J0407366D 1J0407366H, 8Z0407366A
	AU1015 ROTİL SOL	Ağırlık : 0,35 kg / 0.772 lb Konik Ölçüsü : Ø15 Bağlantı Delik Çapı : Ø8,5 Aşık Diş Çapı : M12X1,25	1J0407365A, 1J0407365B 1J0407365C, 1J0407365D
	AU1015K ROTİL ÖN SOL Ø15 RB2529	Ağırlık : 0,5 kg / 1.102 lb Konik Ölçüsü : Ø15 Bağlantı Delik Çapı : Ø8,5 Aşık Diş Çapı : M12X1,25	1J0407365, 1J0407365A* 1J0407365A, 1J0407365AS 1J0407365B*, 1J0407365B 1J0407365C*, 1J0407365C 1J0407365CS, 1J0407365D*
	AU2009 ROTBAŞI SAĞ UZUN RD0332	Ağırlık : 0,37 kg / 0.816 lb Uzunluk : 92 mm / 3.62 inch Gövde Diş Çapı : M14X1,5 Aşık Diş Çapı : M12X1,5 Aşık Konik Çapı : Ø13,3	1J0422812B, 3A0422812B 6R0423812A
	AU2010 ROTBAŞI SOL RD0331	Ağırlık : 0,375 kg / 0.827 lb Uzunluk : 92 mm / 3.62 inch Gövde Diş Çapı : M14X1,5 Aşık Diş Çapı : M12X1,5 Aşık Konik Çapı : Ø13,2	1J0422811B, 1JD422811 3A0422811B, 6R0423811A
	AU2318 ROTBAŞI SOL KISA RB2318	Ağırlık : 0,312 kg / 0.688 lb Uzunluk : 76 mm / 2.99 inch Gövde Diş Çapı : M14X1,5 Aşık Diş Çapı : M12X1,5 Aşık Konik Çapı : Ø13,4	1J0422811, 1J0422811A
	AU2319 ROTBAŞI SAĞ KISA RB2319	Ağırlık : 0,315 kg / 0.694 lb Uzunluk : 76 mm / 2.99 inch Gövde Diş Çapı : M14X1,5 Aşık Diş Çapı : M12X1,5 Aşık Konik Çapı : Ø13,4	1J0422812, 1J0422812A
	AU3001 ROTMİLİ SOL VE SAĞ 318 RD0908	Ağırlık : 0,622 kg / 1.371 lb Uzunluk : 318 mm / 12.52 inch Gövde Diş Çapı : M16X1,5 Aşık Diş Çapı : M14X1,5	1J0422803B, 1J0422804B 1J0422804E, 1J0422807 1J0422807B, 1J0422821B
	AU3003 ROTMİLİ SAĞ-SOL UZUN L 360 MM RB2811	Ağırlık : 0,629 kg / 1.387 lb Uzunluk : 341 mm / 13.43 inch Gövde Diş Çapı : M16X1,5 Aşık Diş Çapı : M14X1,5	1J0422803A, 1J0422804A 1J0422807A, 1J0422807C 1J0422821, 1J0422821A 1J0822807B
	AU3004 ROTMİLİ	Ağırlık : 0.35 kg / 0.772 lb Uzunluk : 320 mm / 12.60 inch	1J0422810B

* Bu sayfada ve katalogdaki tüm araçların adları, markaları, modelleri, sembolleri, logoları, orjinal numaraları (oe) ve diğer üçüncü parti numaraları sadece referans amaçlı kullanılmaktadır.

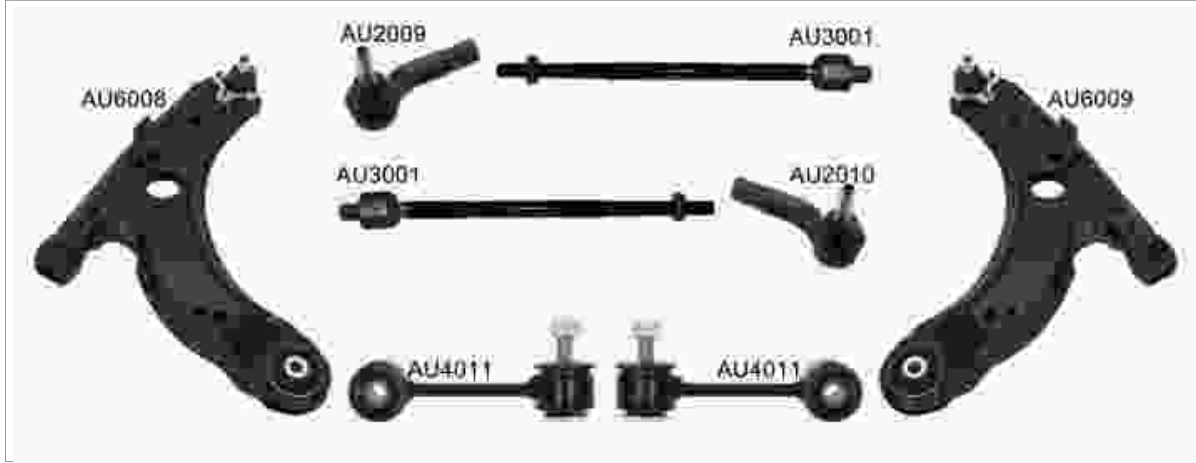
VW8001 / Süspansiyon Kit Ön
OCTAVIA
I COMBI 1U5
1996 - 2004

Kit Parçaları











Resim	Ürün Kodu / Adı	OEM	OEM	Ürün Kodu / Adı	Resim
	AU2009 Rotbaşı Sağ Uzun Rd0332	1J0422812B, 3A0422812B 6R0423812A	1J0422811B, 1JD422811 3A0422811B, 6R0423811A	AU2010 Rotbaşı Sol Rd0331	
	AU3001 Rotmili Sol Ve Sağ 318 Rd0908	1J0422803B, 1J0422804B 1J0422804E, 1J0422807 1J0422807B, 1J0422821B	1J0411315E, 1J0411315G 1J0422315G	VW4011 Z Rot Ön Sağ-sol Metal 105 Rd0916	
	AU6008 Salıncak Ön Sağ Rb3011	1J0407151B	1J0407151A	AU6009 Salıncak Ön Sol Rb3012	

OCTAVIA
I COMBI 1U5
1996 - 2004

Resim	Ürün Kodu ve Açıklaması	Detay	OEM
	AU20093001 ROT TAKIMI SAĞ	Ağırlık : 0,951 kg / 2.097 lb Rotbaşı : AU2009 Rotmili : AU3001	1H0422804B
	AU20103001 ROT TAKIMI SOL	Ağırlık : 0,952 kg / 2.099 lb Rotbaşı : AU2010 Rotmili : AU3001	1H0422803B
	AU23183003 ROT TAKIMI SAĞ RB288113	Ağırlık : 0,945 kg / 2.083 lb Rotbaşı : AU2318 Rotmili : AU3003	1J0422804, 1J0422804A 1J0422804C
	AU23183004 ROT TAKIMI SOL RD088206	Ağırlık : 1,075 kg / 2.370 lb Rotbaşı : AU2318 Rotmili : AU3004	1J0422803B
	AU23193003 ROT TAKIMI SOL RB288112	Ağırlık : 0,94 kg / 2.072 lb Rotbaşı : AU2319 Rotmili : AU3003	1J0422803, 1J0422803A 1J0422803C
	AU23193004 ROT TAKIMI SAĞ RD088207	Ağırlık : 1,1 kg / 2.425 lb Rotbaşı : AU2319 Rotmili : AU3004	1J0422804B
	VW4010 Z ROT SOL VE SAĞ PLASTİK RD0924	Ağırlık : 0,18 kg / 0.397 lb Malzeme Türü : Plastik Uzunluk : 106 mm / 4.17 inch Aşık Diş Çapı : M10X1,5	1J0411315C, 1J0411315J
	VW4011 Z ROT ÖN SAĞ-SOL METAL 105 RD0916	Ağırlık : 0,258 kg / 0.569 lb Malzeme Türü : Metal Uzunluk : 106 mm / 4.17 inch Aşık Diş Çapı : M10X1,5	1J0411315E, 1J0411315G 1J0422315G
	VW4020 Z ROT ÖN SAĞ-SOL PLASTİK 105,5	Ağırlık : 0,151 kg / 0.333 lb Malzeme Türü : Plastik Uzunluk : 105 mm / 4.13 inch	1J0411315B, 1J0411315H 1J0411315K
	AU6008 SALINCAK ÖN SAĞ RB3011	Ağırlık : 3,495 kg / 7.705 lb Malzeme Türü : Sac Metal	1J0407151B
	AU6008J SALINCAK ÖN SAĞ RB3101	Ağırlık : 3,212 kg / 7.081 lb Malzeme Türü : Sac Metal	1J0407151C

* Bu sayfada ve katalogdaki tüm araçların adları, markaları, modelleri, sembolleri, logoları, orijinal numaraları (oe) ve diğer üçüncü parti numaraları sadece referans amaçlı kullanılmaktadır.

OCTAVIA
I COMBI 1U5
1996 - 2004

Resim	Ürün Kodu ve Açıklaması	Detay	OEM
	AU6009 SALINCAK ÖN SOL RB3012	Ağırlık : 3,495 kg / 7.705 lb Malzeme Türü : Sac Metal	1J0407151A
	AU11002 SALINCAK VE DENGE KOLU BURCU ÖN SOL VE SAĞ B22117	Şasi (Ön / Arka) : ÖN Yön : Sol Ve Sağ Ağırlık : 0,108 kg / 0.238 lb	1J0407181, 1J0407181A
	AU11005 SALINCAK VE DENGE KOLU BURCU ÖN ORTA SOL VE SAĞ B40115	Şasi (Ön / Arka) : ÖN Yön : Orta Sol Ve Sağ Ağırlık : 0,111 kg / 0.245 lb Not : VW6014 - VW60614J	191407182, 357407182 357407182F
	VW11036 SALINCAK VE DENGE KOLU BURCU SOL VE SAĞ	Yön : Sol Ve Sağ Ağırlık : 0.07 kg / 0.154 lb Not : BORUSU	191411315B, 4A0399413A
	VW11090 Z-ROT BURCU ÖN	Şasi (Ön / Arka) : ÖN Ağırlık : 0,045 kg / 0.099 lb	1J0411315*, 1J0411315B* 1J0411315C*, 1J0411315E* 1J0411315G*, 1J0411315J*
	VW11008 TAŞIYICI DESTEK BURÇLARI SOL VE SAĞ	Yön : Sol Ve Sağ Ağırlık : 0.24 kg / 0.529 lb	1J0505203, 1J0505365D 1J0505365F, 1J0505365G 1J0505365J, 1J0505365K 1J0505365M, 1J0505365N
	SK11011 TORSİYON BURCU SOL VE SAĞ	Yön : Sol Ve Sağ Ağırlık : 0,346 kg / 0.763 lb	6R0501541A
	VW12016 VİRAJ DEMİR LASTİĞİ SOL VE SAĞ RUBBER	Şasi (Ön / Arka) : ÖN Yön : Sol Ve Sağ Ağırlık : 0.03 kg / 0.066 lb Malzeme Türü : Rubber	1J0411314G, 1J0411314T 8N0411303G, 8N0411303H
	VW12016K VİRAJ DEMİR LASTİĞİ SOL VE SAĞ RUBBER	Şasi (Ön / Arka) : ÖN Yön : Sol Ve Sağ Ağırlık : 0.06 kg / 0.132 lb Malzeme Türü : Rubber Not : İKİLİ	1J0411314G, 1J0411314T 8N0411303G, 8N0411303H
	VW12020 VİRAJ DEMİR LASTİĞİ SOL VE SAĞ RUBBER	Şasi (Ön / Arka) : ÖN Yön : Sol Ve Sağ Ağırlık : 0.07 kg / 0.154 lb Malzeme Türü : Rubber Not : VİRAJ ORTA LASTİĞİ	8D0511327C
	VW12020K VİRAJ DEMİR LASTİĞİ SOL VE SAĞ RUBBER	Şasi (Ön / Arka) : ÖN Yön : Sol Ve Sağ Ağırlık : 0.14 kg / 0.309 lb Malzeme Türü : Rubber	8D0511327C*









* Bu sayfada ve katalogdaki tüm araçların adları, markaları, modelleri, sembolleri, logoları, orijinal numaraları (oe) ve diğer üçüncü parti numaraları sadece referans amaçlı kullanılmaktadır.

OCTAVIA
I COMBI 1U5
1996 - 2004

Resim	Ürün Kodu ve Açıklaması	Detay	OEM
	VW12047 VİRAJ DEMİR LASTİĞİ SOL VE SAĞ RUBBER	Şasi (Ön / Arka) : ÖN Yön : Sol Ve Sağ Ağırlık : 0.14 kg / 0.309 lb Malzeme Türü : Rubber Not : VİRAJ LASTİĞİ	1J0411314B, 1J0411314S
	VW12047K VİRAJ DEMİR LASTİĞİ SOL VE SAĞ RUBBER	Şasi (Ön / Arka) : ÖN Yön : Sol Ve Sağ Ağırlık : 0.28 kg / 0.617 lb Malzeme Türü : Rubber Not : VİRAJ LASTİĞİ (2 ADET)	1J0411314B*, 1J0411314B 1J0411314S*, 1J0411314S
	VW12048 VİRAJ DEMİR LASTİĞİ SOL VE SAĞ RUBBER	Şasi (Ön / Arka) : ÖN Yön : Sol Ve Sağ Ağırlık : 0.03 kg / 0.066 lb Malzeme Türü : Rubber Not : VİRAJ LASTİĞİ	1J0411314P
	VW12048K VİRAJ DEMİR LASTİĞİ SOL VE SAĞ RUBBER	Şasi (Ön / Arka) : ÖN Yön : Sol Ve Sağ Ağırlık : 0.06 kg / 0.132 lb Malzeme Türü : Rubber	1J0411314P*
	VW12052 VİRAJ DEMİR LASTİĞİ SOL VE SAĞ RUBBER	Şasi (Ön / Arka) : ÖN Yön : Sol Ve Sağ Ağırlık : 0.06 kg / 0.132 lb Malzeme Türü : Rubber Not : VİRAJ LASTİĞİ	1J0411314R
	VW12052K VİRAJ DEMİR LASTİĞİ SOL VE SAĞ RUBBER	Şasi (Ön / Arka) : ÖN Yön : Sol Ve Sağ Ağırlık : 0.12 kg / 0.265 lb Malzeme Türü : Rubber	1J0411314R*
	VW12064 VİRAJ DEMİR LASTİĞİ SOL VE SAĞ RUBBER	Şasi (Ön / Arka) : ÖN Yön : Sol Ve Sağ Ağırlık : 0,023 kg / 0.051 lb Malzeme Türü : Rubber Not : D=Ø21mm	1J0411314C, 1J0411314R
	VW12064K VİRAJ DEMİR LASTİĞİ SOL VE SAĞ RUBBER	Şasi (Ön / Arka) : ÖN Yön : Sol Ve Sağ Ağırlık : 0.046 kg / 0.101 lb Malzeme Türü : Rubber	1J0411314C*
	VW12117 VİRAJ DEMİR LASTİĞİ SOL VE SAĞ RUBBER	Şasi (Ön / Arka) : ÖN Yön : Sol Ve Sağ Ağırlık : 0.08 kg / 0.176 lb Malzeme Türü : Rubber	1J0411327
	VW12117K VİRAJ DEMİR LASTİĞİ SOL VE SAĞ RUBBER	Şasi (Ön / Arka) : ÖN Yön : Sol Ve Sağ Ağırlık : 0.16 kg / 0.353 lb Malzeme Türü : Rubber	1J0411327
	SK12002 AMORTİSÖR TAKOZU ARKA SOL VE SAĞ 1.2 / 1.4TSI / 1.6TDI / 1.2TDI	Şasi (Ön / Arka) : ARKA Yön : Sol Ve Sağ Ağırlık : 0,305 kg / 0.672 lb Not : 1.2 / 1.4TSI / 1.6TDI / 1.2TDI	1J0513353A, 1J0513353B 1J0513353C, 1J0513353G 6QE513353, 6R0513353 6R0513353B

* Bu sayfada ve katalogdaki tüm araçların adları, markaları, modelleri, sembolleri, logoları, orjinal numaraları (oe) ve diğer üçüncü parti numaraları sadece referans amaçlı kullanılmaktadır.

OCTAVIA
I COMBI 1U5
1996 - 2004









Resim	Ürün Kodu ve Açıklaması	Detay	OEM
	VW12061 AMORTİSÖR TAKOZU SOL VE SAĞ AMORTİSÖR TAKOZU	Yön : Sol Ve Sağ Ağırlık : 0.27 kg / 0.595 lb Not : AMORTİSÖR TAKOZU	1H0412365A, 1J0412249 1J0412331BS, 1J0412331C
	VW12061A AMORTİSÖR TAKOZU SOL VE SAĞ AMORTİSOR RULMANI	Yön : Sol Ve Sağ Ağırlık : 0.08 kg / 0.176 lb Not : AMORTİSOR RULMANI	1J0412249, 1J0412249C 357412249, 357412249A 4503300051, 7201688 7201848, 95VW3K031AA
	VW12061K AMORTİSÖR TAKOZU SOL VE SAĞ 2 PCS	Yön : Sol Ve Sağ Ağırlık : 0.7 kg / 1.543 lb Not : 2 PCS	1H0412365A, 1J0412249 1J0412331BS, 1J0412331C
	VW12103 AMORTİSÖR TAKOZU SOL VE SAĞ AMORTİSÖR ÜST TAKOZU	Yön : Sol Ve Sağ Ağırlık : 0.23 kg / 0.507 lb Not : AMORTİSÖR ÜST TAKOZU	1J0412331B, 1J0412331C
	VW12096 SÜSPANSİYON TAKOZU SOL VE SAĞ SÜSPANSİYON TAKOZU	Yön : Sol Ve Sağ Ağırlık : 0.035 kg / 0.077 lb Not : SÜSPANSİYON TAKOZU	1J0412303
	VW13002 RIW DİREKSİYON KÖRÜĞÜ	Ağırlık : 0.1 kg / 0.220 lb	1J0422831, 1J0422831B 8N0422831
	VW13002K DİREKSİYON KÖRÜĞÜ SOL VE SAĞ 2 PİECES	Ağırlık : 0.2 kg / 0.441 lb	1J0422831, 1J0422831B 8N0422831
	VW13006 DİREKSİYON KÖRÜĞÜ	Ağırlık : 0.145 kg / 0.320 lb	1K0423831A, 5C0423831
	VW13006K DİREKSİYON KÖRÜĞÜ SOL VE SAĞ 2 PİECES	Ağırlık : 0.29 kg / 0.639 lb	1K0423831A, 5C0423831
	F114014 AKS KÖRÜĞÜ +KELEPÇE+YAĞ. DIŞ	Ağırlık : 0.211 kg / 0.465 lb	46307841
	VW14003 AKS KÖRÜĞÜ +KELEPÇE+YAĞ. DIŞ	Ağırlık : 0.25 kg / 0.551 lb	1K0 498 203, 1K0498203

* Bu sayfada ve katalogdaki tüm araçların adları, markaları, modelleri, sembolleri, logoları, orjinal numaraları (oe) ve diğer üçüncü parti numaraları sadece referans amaçlı kullanılmaktadır.

OCTAVIA
I COMBI 1U5
1996 - 2004









Resim	Ürün Kodu ve Açıklaması	Detay	OEM
	VW15002 AMORTİSÖR KÖRÜĞÜ ARKA	Şasi (Ön / Arka) : ARKA	900064

OCTAVIA
II 1Z3
2004 - 2013

Resim	Ürün Kodu ve Açıklaması	Detay	OEM
	VW1014 ROTİL ÖN ALT SAĞ Ø15,6 RB2536	Ağırlık : 0,565 kg / 1.246 lb Konik Ölçüsü : Ø15,6 Bağlantı Delik Çapı : Ø10,5 Aşık Diş Çapı : M12X1,5	1K0407366B, 1K0407366C 1K0407366E, 5Q0407366A
	VW1015 ROTİL ÖN ALT SOL Ø15,6 RB2537	Ağırlık : 0,565 kg / 1.246 lb Konik Ölçüsü : Ø15,6 Bağlantı Delik Çapı : Ø10,5 Aşık Diş Çapı : M12X1,5	1K0407365B, 1K0407365C 1K0407365E, 5Q0407365A
	VW2008 ROTBAŞI ÖN SAĞ RD0342	Ağırlık : 0,412 kg / 0.908 lb Uzunluk : 95 mm / 3.74 inch Gövde Diş Çapı : M16X1,5 Aşık Diş Çapı : M12X1,5 Aşık Konik Çapı : Ø12,7	1K0423812A, 1K0423812C 1K0423812E, 1K0423812G 1K0423812J, 1K0423812K 1KD423812A
	VW2009 ROTBAŞI ÖN SOL RD0343	Ağırlık : 0,412 kg / 0.908 lb Uzunluk : 95 mm / 3.74 inch Gövde Diş Çapı : M16X1,5 Aşık Diş Çapı : M12X1,5 Aşık Konik Çapı : Ø13,5	1K0423811A, 1K0423811C 1K0423811E, 1K0423811G 1K0423811J, 1K0423811K 1KD423811A
	VW3009 ROTMİLİ SAĞ-SOL 310 RB2838	Ağırlık : 0,665 kg / 1.466 lb Uzunluk : 311 mm / 12.24 inch Gövde Diş Çapı : M16X1,5 Aşık Diş Çapı : M16X1,5	1K0423810A
	VW20083009 ROT TAKIMI ÖN AKS SAĞ RB288137	Ağırlık : 1,078 kg / 2.377 lb Rotbaşı : VW2008 Rotmilî : VW3009	
	VW20093009 ROT TAKIMI ÖN SOL RB288138	Ağırlık : 1,077 kg / 2.374 lb Rotbaşı : VW2009 Rotmilî : VW3009	
	SK4005 Z ROT ÖM SAĞ-SOL L=335MM	Ağırlık : 0,322 kg / 0.710 lb Malzeme Türü : Metal Uzunluk : 335 mm / 13.19 inch Aşık Diş Çapı : M12X1,5	5Q0411315B
	VW4014 Z ROT ÖN SAĞ-SOL METAL 335 RB2935	Ağırlık : 0,46 kg / 1.014 lb Malzeme Türü : Metal Uzunluk : 335 mm / 13.19 inch Aşık Diş Çapı : M12X1,5	1K0411315B, 1K0411315D 1K0411315J, 1K0411315K 1K0411315R, 5Q0411315A 5Q0411315B











* Bu sayfada ve katalogdaki tüm araçların adları, markaları, modelleri, sembolleri, logoları, orjinal numaraları (oe) ve diğer üçüncü parti numaraları sadece referans amaçlı kullanılmaktadır.

OCTAVIA
II 1Z3
2004 - 2013

Resim	Ürün Kodu ve Açıklaması	Detay	OEM
	VW4015 Z ROT SOL VE SAĞ METAL RB2937	Ağırlık : 0,373 kg / 0.822 lb Malzeme Türü : Metal Uzunluk : 95,5 mm / 3.76 inch Aşık Diş Çapı : M10X1,5	1K0505465C, 1K0505465D 1K0505465H, 1K0505465J 1K0505465K
	VW4015K Z ROT SOL VE SAĞ METAL	Ağırlık : 0,373 kg / 0.822 lb Malzeme Türü : Metal Uzunluk : 95,5 mm / 3.76 inch Aşık Diş Çapı : M10X1,5	1K0505465C, 1K0505465D 1K0505465H, 1K0505465J 1K0505465K
	AU6010 SALINCAK ÜST SOL VE SAĞ RA5155	Ağırlık : 1,298 kg / 2.862 lb Malzeme Türü : Sac Metal	1K0505323H, 1K0505323N
	SE9001 SALINCAK ALT SAĞ RA5150	Ağırlık : 1 kg / 2.205 lb Malzeme Türü : Sac Metal	1K0501530C
	SE9002 SALINCAK ALT SOL RA5151	Ağırlık : 1 kg / 2.205 lb Malzeme Türü : Sac Metal	1K0501529F
	VW6016 SALINCAK ÖN SAĞ RD10227	Ağırlık : 4,543 kg / 10.016 lb Malzeme Türü : Sac Metal	1K0407152P, 1K0407152Q* 1K0407152Q
	VW6016J SALINCAK ÖN ALT SAĞ S737	Ağırlık : 4,015 kg / 8.852 lb Malzeme Türü : Sac Metal	1K0407151P, 1K0407151Q 1K0407152P, 1K0407152Q
	VW6017 SALINCAK ÖN SOL RD10226	Ağırlık : 4,543 kg / 10.016 lb Malzeme Türü : Sac Metal	1K0407151M*, 1K0407151P 1K0407151Q*, 1K0407151Q
	VW6017J SALINCAK ÖN ALT SOL S738	Ağırlık : 4,015 kg / 8.852 lb Malzeme Türü : Sac Metal	1K0407151P, 1K0407151Q 1K0407152P, 1K0407152Q
	VW6018J SALINCAK ÖN SAĞ RB30211	Ağırlık : 4,232 kg / 9.330 lb Malzeme Türü : Döküm Çelik	1K0407152AC, 1K0407152M 1K0407152R
	VW6019J SALINCAK ÖN SOL RB30212	Ağırlık : 4,232 kg / 9.330 lb Malzeme Türü : Döküm Çelik	1K0407151AC, 1K0407151M 1K0407151R



* Bu sayfada ve katalogdaki tüm araçların adları, markaları, modelleri, sembolleri, logoları, orjinal numaraları (oe) ve diğer üçüncü parti numaraları sadece referans amaçlı kullanılmaktadır.

OCTAVIA
II 1Z3
2004 - 2013

Resim	Ürün Kodu ve Açıklaması	Detay	OEM
	VW9001 SALINCAK ARKA	Ağırlık : 2,55 kg / 5.622 lb Malzeme Türü : Sac Metal	1K0505311AA, 1K0505311ABÂ 1K0505311H, 1K0505311S 1K0505311T
	AU11014 SALINCAK VE DENGE KOLU BURCU ARKA SOL VE SAĞ	Şasi (Ön / Arka) : ARKA Yön : Sol Ve Sağ Ağırlık : 0.192 kg / 0.423 lb	1K0505543A
	AU11035 SALINCAK VE DENGE KOLU BURCU ARKA SOL VE SAĞ	Şasi (Ön / Arka) : ARKA Yön : Sol Ve Sağ Ağırlık : 0,25 kg / 0.551 lb	1K0505171C
	AU11052 SALINCAK VE DENGE KOLU BURCU SOL VE SAĞ	Yön : Sol Ve Sağ Ağırlık : 0,178 kg / 0.392 lb	1K0505541B, 1K0505541C 1K0505541D
	VW11037 SALINCAK VE DENGE KOLU BURCU SOL VE SAĞ	Yön : Sol Ve Sağ Ağırlık : 0.11 kg / 0.243 lb	1K0505279A
	VW11042 SALINCAK VE DENGE KOLU BURCU ORTA SOL VE SAĞ	Yön : Orta Sol Ve Sağ Ağırlık : 0,182 kg / 0.401 lb	1K0407182, 5Q0407182
	VW11043 SALINCAK VE DENGE KOLU BURCU SAĞ B22141	Yön : Sağ Diğer Taraf : VW11044 Ağırlık : 0,659 kg / 1.453 lb	1K0199232G, 1K0199232H 1K0199232J
	VW11043B SALINCAK VE DENGE KOLU BURCU SAĞ	Yön : Sağ Diğer Taraf : VW11044B Ağırlık : 0,659 kg / 1.453 lb Not : İÇ BURÇSUZ	1K0199232G, 1K0199232H 1K0199232J
	VW11044 SALINCAK VE DENGE KOLU BURCU SOL B22142	Yön : Sol Diğer Taraf : VW11043 Ağırlık : 0,678 kg / 1.495 lb	1K0199231G, 1K0199231H 1K0199231J
	VW11044B SALINCAK VE DENGE KOLU BURCU SOL	Yön : Sol Diğer Taraf : VW11043B Ağırlık : 0,678 kg / 1.495 lb Not : İÇ BURÇSUZ	1K0199231G, 1K0199231H 1K0199231J
	VW11047 SALINCAK VE DENGE KOLU BURCU İÇ SOL VE SAĞ B37117	Yön : İç Sol Ve Sağ Ağırlık : 0,121 kg / 0.267 lb	1K0199231J, 1K0199231J-P 1K0407183E

* Bu sayfada ve katalogdaki tüm araçların adları, markaları, modelleri, sembolleri, logoları, orijinal numaraları (oe) ve diğer üçüncü parti numaraları sadece referans amaçlı kullanılmaktadır.

OCTAVIA
II 1Z3
2004 - 2013

Resim	Ürün Kodu ve Açıklaması	Detay	OEM
	VW11051 SALINCAK VE DENGE KOLU BURCU SOL VE SAĞ	Yön : Sol Ve Sağ Ağırlık : 0.121 kg / 0.267 lb	6Q0407183, 6Q0407183A
	VW11055 SALINCAK VE DENGE KOLU BURCU İÇ SOL VE SAĞ	Yön : İç Sol Ve Sağ Ağırlık : 0.121 kg / 0.267 lb	1K0407183E, 8J0407183
	VW11056 SALINCAK VE DENGE KOLU BURCU ARKA SOL VE SAĞ	Şasi (Ön / Arka) : ARKA Yön : Sol Ve Sağ Ağırlık : 0.13 kg / 0.287 lb	1K0505203A, 1K0505323D 1K0505323G, 1K0505323H 1K0505323N, 5Q0505323C
	VW11180 Z-ROT BURCU ARKA	Şasi (Ön / Arka) : ARKA Ağırlık : 0.069 kg / 0.152 lb Uzunluk : VW4015 mm / 0.00 inch Aşık Diş Çapı : VW4015K	1K0505465C*, 1K0505465D* 1K0505465H*, 1K0505465J* 1K0505465K*
	VW12159 TAŞIYICI DESTEK BURÇLARI ARKA SOL VE SAĞ	Şasi (Ön / Arka) : ARKA Yön : Sol Ve Sağ Ağırlık : 0,130 kg / 0.287 lb	1K0505553, 1K0505553A
	SK12003 VİRAJ DEMİR LASTİĞİ SOL VE SAĞ RUBBER	Şasi (Ön / Arka) : ÖN Yön : Sol Ve Sağ Ağırlık : 0,075 kg / 0.165 lb Malzeme Türü : Rubber	1K0411303, 1K0411303AL* 1K0411303BK, 1K0411314 3C0411303AA*, 3C0411303T*
	SK12003K VİRAJ DEMİR LASTİĞİ SOL VE SAĞ RUBBER	Şasi (Ön / Arka) : ÖN Yön : Sol Ve Sağ Ağırlık : 0,150 kg / 0.331 lb Malzeme Türü : Rubber	1K0411303, 1K0411303AL* 1K0411303BK, 1K0411314 3C0411303AA*, 3C0411303T*
	VW12017 AMORTİSÖR TAKOZU SOL VE SAĞ AMORTİSÖR TAKOZU	Yön : Sol Ve Sağ Ağırlık : 0.847 kg / 1.867 lb Not : AMORTİSÖR TAKOZU	1K0412331B, 1K0412331C
	VW12061 AMORTİSÖR TAKOZU SOL VE SAĞ AMORTİSÖR TAKOZU	Yön : Sol Ve Sağ Ağırlık : 0.27 kg / 0.595 lb Not : AMORTİSÖR TAKOZU	1H0412365A, 1J0412249 1J0412331BS, 1J0412331C
	VW12061A AMORTİSÖR TAKOZU SOL VE SAĞ AMORTİSÖR RULMANI	Yön : Sol Ve Sağ Ağırlık : 0.08 kg / 0.176 lb Not : AMORTİSÖR RULMANI	1J0412249, 1J0412249C 357412249, 357412249A 4503300051, 7201688 7201848, 95VW3K031AA
	VW12061K AMORTİSÖR TAKOZU SOL VE SAĞ 2 PCS	Yön : Sol Ve Sağ Ağırlık : 0.7 kg / 1.543 lb Not : 2 PCS	1H0412365A, 1J0412249 1J0412331BS, 1J0412331C

* Bu sayfada ve katalogdaki tüm araçların adları, markaları, modelleri, sembolleri, logoları, orijinal numaraları (oe) ve diğer üçüncü parti numaraları sadece referans amaçlı kullanılmaktadır.

OCTAVIA
II 1Z3
2004 - 2013

Resim	Ürün Kodu ve Açıklaması	Detay	OEM
	VW12109 AMORTİSÖR TAKOZU SOL VE SAĞ AMORTİSÖR RULMANI	Yön : Sol Ve Sağ Ağırlık : 0.26 kg / 0.573 lb Not : AMORTİSÖR RULMANI	6N0412249C, 6N0412249E
	VW12109K AMORTİSÖR TAKOZU SOL VE SAĞ 2 PCS	Yön : Sol Ve Sağ Ağırlık : 0.52 kg / 1.146 lb Not : 2 PCS	6N0412249C, 6N0412249E
	VW12025 MOTOR TAKOZU ALT SOL VE SAĞ MOTOR TAKOZU ALT	Yön : Alt Sol Ve Sağ Ağırlık : 0.25 kg / 0.551 lb Not : MOTOR TAKOZU ALT	1K0199867A, 1K0199867B 1K0199867Q
	VW12027 MOTOR TAKOZU SOL VE SAĞ MOTOR KULAĞI	Yön : Sol Ve Sağ Ağırlık : 2.02 kg / 4.453 lb Not : MOTOR KULAĞI	1K0199262, 1K0199262CN
	VW12029 MOTOR TAKOZU SOL VE SAĞ MOTOR TAKOZU	Yön : Sol Ve Sağ Ağırlık : 0.585 kg / 1.290 lb Not : Motor takozu	1K0199855AD, 1K0199855BA 1K0199855K
	VW12032 MOTOR TAKOZU SOL VE SAĞ MOTOR TAKOZU	Yön : Sol Ve Sağ Ağırlık : 0.64 kg / 1.411 lb Not : Motor takozu	1K0199855BB, 1K0199855L
	VW12033 MOTOR TAKOZU SOL VE SAĞ MOTOR TAKOZU	Yön : Sol Ve Sağ Ağırlık : 1.84 kg / 4.057 lb Not : Motor takozu	1K0199555AQ, 1K0199555AR 1K0199555Q, 1K0199555R 3C0199555AA, 3C0199555R
	VW12034 MOTOR TAKOZU SOL VE SAĞ MOTOR TAKOZU	Yön : Sol Ve Sağ Ağırlık : 1.9 kg / 4.189 lb Not : Motor takozu	1K0199555BA, 1K0199555BB 1K0199555L, 1K0199555M 1L0199555L
	VW12073 MOTOR TAKOZU SOL VE SAĞ MOTOR TAKOZU	Yön : Sol Ve Sağ Ağırlık : 1.643 kg / 3.622 lb Not : MOTOR TAKOZU	1K0199262AC, 1K0199262AL 1K0199262L
	VW12076 MOTOR TAKOZU SOL VE SAĞ MOTOR TAKOZU	Yön : Sol Ve Sağ Ağırlık : 1.97 kg / 4.343 lb Not : MOTOR TAKOZU	1K0199262AF, 1K0199262AT 1K0199262BB
	VW12077 MOTOR TAKOZU SOL VE SAĞ MOTOR TAKOZU	Yön : Sol Ve Sağ Ağırlık : 1.95 kg / 4.299 lb Not : MOTOR TAKOZU	1K0199262CG, 1K0199262CP







* Bu sayfada ve katalogdaki tüm araçların adları, markaları, modelleri, sembolleri, logoları, orjinal numaraları (oe) ve diğer üçüncü parti numaraları sadece referans amaçlı kullanılmaktadır.

OCTAVIA
II 1Z3
2004 - 2013



Resim	Ürün Kodu ve Açıklaması	Detay	OEM
	VW12078 MOTOR TAKOZU SOL VE SAĞ ŞANZUMAN TAKOZU	Yön : Sol Ve Sağ Ağırlık : 1.78 kg / 3.924 lb Not : ŞANZUMAN TAKOZU	1K0199555AC
	VW12082 MOTOR TAKOZU SOL VE SAĞ MOTOR TAKOZU	Yön : Sol Ve Sağ Ağırlık : 2.05 kg / 4.519 lb Not : MOTOR TAKOZU	1K0199262AK, 1K0199262K
	VW12094 MOTOR TAKOZU SOL VE SAĞ MOTOR TAKOZU	Yön : Sol Ve Sağ Ağırlık : 1.872 kg / 4.127 lb Not : MOTOR TAKOZU	1K0199555N
	VW12097 MOTOR TAKOZU SOL VE SAĞ MOTOR TAKOZU	Yön : Sol Ve Sağ Ağırlık : 0.251 kg / 0.553 lb Not : MOTOR TAKOZU	1K0199868, 1K0199868A 1K0199868C, 1K0199868P 1K0199868Q
	VW12110 MOTOR TAKOZU SOL VE SAĞ MOTOR TAKOZU	Yön : Sol Ve Sağ Ağırlık : 1.918 kg / 4.228 lb Not : MOTOR TAKOZU	1K0199262AB, 1K0199262AM 1K0199262M
	VW12124 MOTOR TAKOZU SOL VE SAĞ	Yön : Sol Ve Sağ Ağırlık : 1.927 kg / 4.248 lb	1K0199262A, 1K0199262AA 1K0199262AS
	VW12106 ŞANZIMAN TAKOZU SOL ŞANZUMAN TAKOZU SOL	Yön : Sol Ağırlık : 1.95 kg / 4.299 lb Not : ŞANZUMAN TAKOZU SOL	1K0199555AT, 1K0199555T
	VW12038 SÜSPANSİYON TAKOZU SOL VE SAĞ SUS. ARA YATAK TAKOZ ARKA	Yön : Sol Ve Sağ Ağırlık : 0.12 kg / 0.265 lb Not : SUS. ARA YATAK TAKOZ ARKA	3C0 511 359, 3C0511359
	VW12051 SÜSPANSİYON TAKOZU SOL VE SAĞ LASTİK DAYANAK SÜSPANSİYON	Yön : Sol Ve Sağ Ağırlık : 0.045 kg / 0.099 lb Not : LASTİK DAYANAK SÜSPANSİYON	1K0412303B
	VW12086 RADYATÖR TAKOZU SOL VE SAĞ RADYATÖR ÜST LASTİĞİ	Yön : Sol Ve Sağ Ağırlık : 0.024 kg / 0.053 lb Not : RADYATÖR ÜST LASTİĞİ	1K0121367F
	VW13002 RIW DİREKSİYON KÖRÜĞÜ	Ağırlık : 0.1 kg / 0.220 lb	1J0422831, 1J0422831B 8N0422831

* Bu sayfada ve katalogdaki tüm araçların adları, markaları, modelleri, sembolleri, logoları, orjinal numaraları (oe) ve diğer üçüncü parti numaraları sadece referans amaçlı kullanılmaktadır.

OCTAVIA
II 1Z3
2004 - 2013











Resim	Ürün Kodu ve Açıklaması	Detay	OEM
	VW13002K DİREKSİYON KÖRÜĞÜ SOL VE SAĞ 2 PİECES	Ağırlık : 0.2 kg / 0.441 lb	1J0422831, 1J0422831B 8N0422831
	VW13006 DİREKSİYON KÖRÜĞÜ	Ağırlık : 0.145 kg / 0.320 lb	1K0423831A, 5C0423831
	VW13006K DİREKSİYON KÖRÜĞÜ SOL VE SAĞ 2 PİECES	Ağırlık : 0.29 kg / 0.639 lb	1K0423831A, 5C0423831
	VW14003 AKS KÖRÜĞÜ +KELEPÇE+YAĞ. DIŞ	Ağırlık : 0.25 kg / 0.551 lb	1K0 498 203, 1K0498203
	VW14011 AKS KÖRÜĞÜ +KELEPÇE+YAĞ. İÇ	Ağırlık : 0.236 kg / 0.520 lb	1K0498201D
	AU15001 AMORTİSÖR KÖRÜĞÜ ÖN	Şasi (Ön / Arka) : ÖN Ağırlık : 0,110 kg / 0.243 lb	6N0413175A
	VW15002 AMORTİSÖR KÖRÜĞÜ ARKA	Şasi (Ön / Arka) : ARKA	900064

OCTAVIA
II COMBI 1Z5
2004 - 2013

Resim	Ürün Kodu ve Açıklaması	Detay	OEM
	VW1014 ROTİL ÖN ALT SAĞ Ø15,6 RB2536	Ağırlık : 0,565 kg / 1.246 lb Konik Ölçüsü : Ø15,6 Bağlantı Delik Çapı : Ø10,5 Aşık Diş Çapı : M12X1,5	1K0407366B, 1K0407366C 1K0407366E, 5Q0407366A
	VW1015 ROTİL ÖN ALT SOL Ø15,6 RB2537	Ağırlık : 0,565 kg / 1.246 lb Konik Ölçüsü : Ø15,6 Bağlantı Delik Çapı : Ø10,5 Aşık Diş Çapı : M12X1,5	1K0407365B, 1K0407365C 1K0407365E, 5Q0407365A
	VW2008 ROTBAŞI ÖN SAĞ RD0342	Ağırlık : 0,412 kg / 0.908 lb Uzunluk : 95 mm / 3.74 inch Gövde Diş Çapı : M16X1,5 Aşık Diş Çapı : M12X1,5 Aşık Konik Çapı : Ø12,7	1K0423812A, 1K0423812C 1K0423812E, 1K0423812G 1K0423812J, 1K0423812K 1KD423812A

* Bu sayfada ve katalogdaki tüm araçların adları, markaları, modelleri, sembolleri, logoları, orjinal numaraları (oe) ve diğer üçüncü parti numaraları sadece referans amaçlı kullanılmaktadır.

OCTAVIA
II COMBI 1Z5
2004 - 2013

Resim	Ürün Kodu ve Açıklaması	Detay	OEM
	VW2009 ROTBAŞI ÖN SOL RD0343	Ağırlık : 0,412 kg / 0.908 lb Uzunluk : 95 mm / 3.74 inch Gövde Diş Çapı : M16X1,5 Aşık Diş Çapı : M12X1,5 Aşık Konik Çapı : Ø13,5	1K0423811A, 1K0423811C 1K0423811E, 1K0423811G 1K0423811J, 1K0423811K 1KD423811A
	VW3009 ROTMİLİ SAĞ-SOL 310 RB2838	Ağırlık : 0,665 kg / 1.466 lb Uzunluk : 311 mm / 12.24 inch Gövde Diş Çapı : M16X1,5 Aşık Diş Çapı : M16X1,5	1K0423810A
	VW20083009 ROT TAKIMI ÖN AKS SAĞ RB288137	Ağırlık : 1,078 kg / 2.377 lb Rotbaşı : VW2008 Rotmilî : VW3009	
	VW20093009 ROT TAKIMI ÖN SOL RB288138	Ağırlık : 1,077 kg / 2.374 lb Rotbaşı : VW2009 Rotmilî : VW3009	
	SK4005 Z ROT ÖM SAĞ-SOL L=335MM	Ağırlık : 0,322 kg / 0.710 lb Malzeme Türü : Metal Uzunluk : 335 mm / 13.19 inch Aşık Diş Çapı : M12X1,5	5Q0411315B
	VW4014 Z ROT ÖN SAĞ-SOL METAL 335 RB2935	Ağırlık : 0,46 kg / 1.014 lb Malzeme Türü : Metal Uzunluk : 335 mm / 13.19 inch Aşık Diş Çapı : M12X1,5	1K0411315B, 1K0411315D 1K0411315J, 1K0411315K 1K0411315R, 5Q0411315A 5Q0411315B
	VW4015 Z ROT SOL VE SAĞ METAL RB2937	Ağırlık : 0,373 kg / 0.822 lb Malzeme Türü : Metal Uzunluk : 95,5 mm / 3.76 inch Aşık Diş Çapı : M10X1,5	1K0505465C, 1K0505465D 1K0505465H, 1K0505465J 1K0505465K
	VW4015K Z ROT SOL VE SAĞ METAL	Ağırlık : 0,373 kg / 0.822 lb Malzeme Türü : Metal Uzunluk : 95,5 mm / 3.76 inch Aşık Diş Çapı : M10X1,5	1K0505465C, 1K0505465D 1K0505465H, 1K0505465J 1K0505465K
	AU6010 SALINCAĞ ÜST SOL VE SAĞ RA5155	Ağırlık : 1,298 kg / 2.862 lb Malzeme Türü : Sac Metal	1K0505323H, 1K0505323N
	SE9001 SALINCAĞ ALT SAĞ RA5150	Ağırlık : 1 kg / 2.205 lb Malzeme Türü : Sac Metal	1K0501530C
	SE9002 SALINCAĞ ALT SOL RA5151	Ağırlık : 1 kg / 2.205 lb Malzeme Türü : Sac Metal	1K0501529F











* Bu sayfada ve katalogdaki tüm araçların adları, markaları, modelleri, sembolleri, logoları, orjinal numaraları (oe) ve diğer üçüncü parti numaraları sadece referans amaçlı kullanılmaktadır.

OCTAVIA
II COMBI 1Z5
2004 - 2013

Resim	Ürün Kodu ve Açıklaması	Detay	OEM
	VW6016 SALINCAK ÖN SAĞ RD10227	Ağırlık : 4,543 kg / 10.016 lb Malzeme Türü : Sac Metal	1K0407152P, 1K0407152Q* 1K0407152Q
	VW6016J SALINCAK ÖN ALT SAĞ S737	Ağırlık : 4,015 kg / 8.852 lb Malzeme Türü : Sac Metal	1K0407151P, 1K0407151Q 1K0407152P, 1K0407152Q
	VW6017 SALINCAK ÖN SOL RD10226	Ağırlık : 4,543 kg / 10.016 lb Malzeme Türü : Sac Metal	1K0407151M*, 1K0407151P 1K0407151Q*, 1K0407151Q
	VW6017J SALINCAK ÖN ALT SOL S738	Ağırlık : 4,015 kg / 8.852 lb Malzeme Türü : Sac Metal	1K0407151P, 1K0407151Q 1K0407152P, 1K0407152Q
	VW6018J SALINCAK ÖN SAĞ RB30211	Ağırlık : 4,232 kg / 9.330 lb Malzeme Türü : Döküm Çelik	1K0407152AC, 1K0407152M 1K0407152R
	VW6019J SALINCAK ÖN SOL RB30212	Ağırlık : 4,232 kg / 9.330 lb Malzeme Türü : Döküm Çelik	1K0407151AC, 1K0407151M 1K0407151R
	VW9001 SALINCAK ARKA	Ağırlık : 2,55 kg / 5.622 lb Malzeme Türü : Sac Metal	1K0505311AA, 1K0505311ABÂ 1K0505311H, 1K0505311S 1K0505311T
	AU11014 SALINCAK VE DENGE KOLU BURCU ARKA SOL VE SAĞ	Şasi (Ön / Arka) : ARKA Yön : Sol Ve Sağ Ağırlık : 0.192 kg / 0.423 lb	1K0505543A
	AU11035 SALINCAK VE DENGE KOLU BURCU ARKA SOL VE SAĞ	Şasi (Ön / Arka) : ARKA Yön : Sol Ve Sağ Ağırlık : 0,25 kg / 0.551 lb	1K0505171C
	AU11052 SALINCAK VE DENGE KOLU BURCU SOL VE SAĞ	Yön : Sol Ve Sağ Ağırlık : 0,178 kg / 0.392 lb	1K0505541B, 1K0505541C 1K0505541D
	VW11037 SALINCAK VE DENGE KOLU BURCU SOL VE SAĞ	Yön : Sol Ve Sağ Ağırlık : 0.11 kg / 0.243 lb	1K0505279A

* Bu sayfada ve katalogdaki tüm araçların adları, markaları, modelleri, sembolleri, logoları, orjinal numaraları (oe) ve diğer üçüncü parti numaraları sadece referans amaçlı kullanılmaktadır.

OCTAVIA
II COMBI 1Z5
2004 - 2013

Resim	Ürün Kodu ve Açıklaması	Detay	OEM
	VW11042 SALINCAK VE DENGE KOLU BURCU ORTA SOL VE SAĞ	Yön : Orta Sol Ve Sağ Ağırlık : 0,182 kg / 0.401 lb	1K0407182, 5Q0407182
	VW11043 SALINCAK VE DENGE KOLU BURCU SAĞ B22141	Yön : Sağ Diğer Taraf : VW11044 Ağırlık : 0,659 kg / 1.453 lb	1K0199232G, 1K0199232H 1K0199232J
	VW11043B SALINCAK VE DENGE KOLU BURCU SAĞ	Yön : Sağ Diğer Taraf : VW11044B Ağırlık : 0,659 kg / 1.453 lb Not : İÇ BURÇSUZ	1K0199232G, 1K0199232H 1K0199232J
	VW11044 SALINCAK VE DENGE KOLU BURCU SOL B22142	Yön : Sol Diğer Taraf : VW11043 Ağırlık : 0,678 kg / 1.495 lb	1K0199231G, 1K0199231H 1K0199231J
	VW11044B SALINCAK VE DENGE KOLU BURCU SOL	Yön : Sol Diğer Taraf : VW11043B Ağırlık : 0,678 kg / 1.495 lb Not : İÇ BURÇSUZ	1K0199231G, 1K0199231H 1K0199231J
	VW11047 SALINCAK VE DENGE KOLU BURCU İÇ SOL VE SAĞ B37117	Yön : İç Sol Ve Sağ Ağırlık : 0,121 kg / 0.267 lb	1K0199231J, 1K0199231J-P 1K0407183E
	VW11051 SALINCAK VE DENGE KOLU BURCU SOL VE SAĞ	Yön : Sol Ve Sağ Ağırlık : 0.121 kg / 0.267 lb	6Q0407183, 6Q0407183A
	VW11055 SALINCAK VE DENGE KOLU BURCU İÇ SOL VE SAĞ	Yön : İç Sol Ve Sağ Ağırlık : 0.121 kg / 0.267 lb	1K0407183E, 8J0407183
	VW11056 SALINCAK VE DENGE KOLU BURCU ARKA SOL VE SAĞ	Şasi (Ön / Arka) : ARKA Yön : Sol Ve Sağ Ağırlık : 0.13 kg / 0.287 lb	1K0505203A, 1K0505323D 1K0505323G, 1K0505323H 1K0505323N, 5Q0505323C
	VW11180 Z-ROT BURCU ARKA	Şasi (Ön / Arka) : ARKA Ağırlık : 0.069 kg / 0.152 lb Uzunluk : VW4015 mm / 0.00 inch Aşık Dış Çapı : VW4015K	1K0505465C*, 1K0505465D* 1K0505465H*, 1K0505465J* 1K0505465K*
	VW12159 TAŞIYICI DESTEK BURÇLARI ARKA SOL VE SAĞ	Şasi (Ön / Arka) : ARKA Yön : Sol Ve Sağ Ağırlık : 0,130 kg / 0.287 lb	1K0505553, 1K0505553A

* Bu sayfada ve katalogdaki tüm araçların adları, markaları, modelleri, sembolleri, logoları, orjinal numaraları (oe) ve diğer üçüncü parti numaraları sadece referans amaçlı kullanılmaktadır.

OCTAVIA
II COMBI 1Z5
2004 - 2013

Resim	Ürün Kodu ve Açıklaması	Detay	OEM
	AU12024 TORSİYON BURCU ARKA SOL VE SAĞ	Şasi (Ön / Arka) : ARKA Yön : Sol Ve Sağ Ağırlık : 0.557 kg / 1.228 lb	1K0505145F, 1K0505145H 1K0505145K
	SK12003 VİRAJ DEMİR LASTİĞİ SOL VE SAĞ RUBBER	Şasi (Ön / Arka) : ÖN Yön : Sol Ve Sağ Ağırlık : 0,075 kg / 0.165 lb Malzeme Türü : Rubber	1K0411303, 1K0411303AL* 1K0411303BK, 1K0411314 3C0411303AA*, 3C0411303T*
	SK12003K VİRAJ DEMİR LASTİĞİ SOL VE SAĞ RUBBER	Şasi (Ön / Arka) : ÖN Yön : Sol Ve Sağ Ağırlık : 0,150 kg / 0.331 lb Malzeme Türü : Rubber	1K0411303, 1K0411303AL* 1K0411303BK, 1K0411314 3C0411303AA*, 3C0411303T*
	VW12017 AMORTİSÖR TAKOZU SOL VE SAĞ AMORTİSÖR TAKOZU	Yön : Sol Ve Sağ Ağırlık : 0.847 kg / 1.867 lb Not : AMORTİSÖR TAKOZU	1K0412331B, 1K0412331C
	VW12061 AMORTİSÖR TAKOZU SOL VE SAĞ AMORTİSÖR TAKOZU	Yön : Sol Ve Sağ Ağırlık : 0.27 kg / 0.595 lb Not : AMORTİSÖR TAKOZU	1H0412365A, 1J0412249 1J0412331BS, 1J0412331C
	VW12061A AMORTİSÖR TAKOZU SOL VE SAĞ AMORTİSÖR RULMANI	Yön : Sol Ve Sağ Ağırlık : 0.08 kg / 0.176 lb Not : AMORTİSÖR RULMANI	1J0412249, 1J0412249C 357412249, 357412249A 4503300051, 7201688 7201848, 95VW3K031AA
	VW12061K AMORTİSÖR TAKOZU SOL VE SAĞ 2 PCS	Yön : Sol Ve Sağ Ağırlık : 0.7 kg / 1.543 lb Not : 2 PCS	1H0412365A, 1J0412249 1J0412331BS, 1J0412331C
	VW12109 AMORTİSÖR TAKOZU SOL VE SAĞ AMORTİSÖR RULMANI	Yön : Sol Ve Sağ Ağırlık : 0.26 kg / 0.573 lb Not : AMORTİSÖR RULMANI	6N0412249C, 6N0412249E
	VW12109K AMORTİSÖR TAKOZU SOL VE SAĞ 2 PCS	Yön : Sol Ve Sağ Ağırlık : 0.52 kg / 1.146 lb Not : 2 PCS	6N0412249C, 6N0412249E
	VW12124 MOTOR TAKOZU SOL VE SAĞ	Yön : Sol Ve Sağ Ağırlık : 1.927 kg / 4.248 lb	1K0199262A, 1K0199262AA 1K0199262AS
	VW12106 ŞANZİMAN TAKOZU SOL ŞANZİMAN TAKOZU SOL	Yön : Sol Ağırlık : 1.95 kg / 4.299 lb Not : ŞANZİMAN TAKOZU SOL	1K0199555AT, 1K0199555T

* Bu sayfada ve katalogdaki tüm araçların adları, markaları, modelleri, sembolleri, logoları, orjinal numaraları (oe) ve diğer üçüncü parti numaraları sadece referans amaçlı kullanılmaktadır.

OCTAVIA
II COMBI 1Z5
2004 - 2013

Resim	Ürün Kodu ve Açıklaması	Detay	OEM
	VW12038 SÜSPANSİYON TAKOZU SOL VE SAĞ SUS. ARA YATAK TAKOZ ARKA	Yön : Sol Ve Sağ Ağırlık : 0.12 kg / 0.265 lb Not : SUS. ARA YATAK TAKOZ ARKA	3C0 511 359, 3C0511359
	VW12051 SÜSPANSİYON TAKOZU SOL VE SAĞ LASTİK DAYANAK SUSPENSİYON	Yön : Sol Ve Sağ Ağırlık : 0.045 kg / 0.099 lb Not : LASTİK DAYANAK SUSPENSİYON	1K0412303B
	VW12086 RADYATÖR TAKOZU SOL VE SAĞ RADYATÖR ÜST LASTİĞİ	Yön : Sol Ve Sağ Ağırlık : 0.024 kg / 0.053 lb Not : RADYATÖR ÜST LASTİĞİ	1K0121367F
	VW13002 RIW DİREKSİYON KÖRÜĞÜ	Ağırlık : 0.1 kg / 0.220 lb	1J0422831, 1J0422831B 8N0422831
	VW13002K DİREKSİYON KÖRÜĞÜ SOL VE SAĞ 2 PİECES	Ağırlık : 0.2 kg / 0.441 lb	1J0422831, 1J0422831B 8N0422831
	VW13006 DİREKSİYON KÖRÜĞÜ	Ağırlık : 0.145 kg / 0.320 lb	1K0423831A, 5C0423831
	VW13006K DİREKSİYON KÖRÜĞÜ SOL VE SAĞ 2 PİECES	Ağırlık : 0.29 kg / 0.639 lb	1K0423831A, 5C0423831
	VW14003 AKS KÖRÜĞÜ +KELEPÇE+YAĞ. DIŞ	Ağırlık : 0.25 kg / 0.551 lb	1K0 498 203, 1K0498203
	VW14011 AKS KÖRÜĞÜ +KELEPÇE+YAĞ. İÇ	Ağırlık : 0.236 kg / 0.520 lb	1K0498201D
	AU15001 AMORTİSÖR KÖRÜĞÜ ÖN	Şasi (Ön / Arka) : ÖN Ağırlık : 0,110 kg / 0.243 lb	6N0413175A

OCTAVIA
III COMBI 5E5
2012 - 2020











Resim	Ürün Kodu ve Açıklaması	Detay	OEM
	VW2008 ROTBAŞI ÖN SAĞ RD0342	Ağırlık : 0,412 kg / 0.908 lb Uzunluk : 95 mm / 3.74 inch Gövde Diş Çapı : M16X1,5 Aşık Diş Çapı : M12X1,5 Aşık Konik Çapı : Ø12,7	1K0423812A, 1K0423812C 1K0423812E, 1K0423812G 1K0423812J, 1K0423812K 1KD423812A

OCTAVIA
III 5E3
2012 - 2020

Resim	Ürün Kodu ve Açıklaması	Detay	OEM
	VW1014 ROTİL ÖN ALT SAĞ Ø15,6 RB2536	Ağırlık : 0,565 kg / 1.246 lb Konik Ölçüsü : Ø15,6 Bağlantı Delik Çapı : Ø10,5 Aşık Diş Çapı : M12X1,5	1K0407366B, 1K0407366C 1K0407366E, 5Q0407366A
	VW1015 ROTİL ÖN ALT SOL Ø15,6 RB2537	Ağırlık : 0,565 kg / 1.246 lb Konik Ölçüsü : Ø15,6 Bağlantı Delik Çapı : Ø10,5 Aşık Diş Çapı : M12X1,5	1K0407365B, 1K0407365C 1K0407365E, 5Q0407365A
	VW2008 ROTBAŞI ÖN SAĞ RD0342	Ağırlık : 0,412 kg / 0.908 lb Uzunluk : 95 mm / 3.74 inch Gövde Diş Çapı : M16X1,5 Aşık Diş Çapı : M12X1,5 Aşık Konik Çapı : Ø12,7	1K0423812A, 1K0423812C 1K0423812E, 1K0423812G 1K0423812J, 1K0423812K 1KD423812A
	VW2009 ROTBAŞI ÖN SOL RD0343	Ağırlık : 0,412 kg / 0.908 lb Uzunluk : 95 mm / 3.74 inch Gövde Diş Çapı : M16X1,5 Aşık Diş Çapı : M12X1,5 Aşık Konik Çapı : Ø13,5	1K0423811A, 1K0423811C 1K0423811E, 1K0423811G 1K0423811J, 1K0423811K 1KD423811A
	SK4005 Z ROT ÖM SAĞ-SOL L=335MM	Ağırlık : 0,322 kg / 0.710 lb Malzeme Türü : Metal Uzunluk : 335 mm / 13.19 inch Aşık Diş Çapı : M12X1,5	5Q0411315B
	VW4031 Z ROT ARKA PLASTİK	Ağırlık : 0,15 kg / 0.331 lb Malzeme Türü : Plastik Uzunluk : 70 mm / 2.76 inch Aşık Diş Çapı : M10X1,5	5Q0505465A, 5Q0505465C
	AU9009 SALINCAĞ ALT SOL VE SAĞ	Ağırlık : 2,910 kg / 6.415 lb Malzeme Türü : Sac Metal	5Q0505311C, 5Q0505311D
	AU9012 SALINCAĞ ARKA ALT SAĞ	Ağırlık : 1,640 kg / 3.616 lb Malzeme Türü : Sac Metal	5Q0505224D
	AU9013 SALINCAĞ ARKA ALT SOL	Ağırlık : 1,640 kg / 3.616 lb Malzeme Türü : Sac Metal	5Q0505223D

* Bu sayfada ve katalogdaki tüm araçların adları, markaları, modelleri, sembolleri, logoları, orijinal numaraları (oe) ve diğer üçüncü parti numaraları sadece referans amaçlı kullanılmaktadır.

OCTAVIA
III 5E3
2012 - 2020

Resim	Ürün Kodu ve Açıklaması	Detay	OEM
	VW6039 SALINCAK ÖN ALT SAĞ METAL	Ağırlık : 3,763 kg / 8.296 lb Malzeme Türü : Sac Metal	5Q0407152J*, 5Q0407152J 5Q0407152L
	VW6039J SALINCAK ÖN ALT SAĞ METAL	Ağırlık : 3,206 kg / 7.068 lb Malzeme Türü : Sac Metal	5Q0407152J*, 5Q0407152J 5Q0407154E
	VW6040 SALINCAK ÖN ALT SOL METAL	Ağırlık : 3,763 kg / 8.296 lb Malzeme Türü : Sac Metal	5Q0407151J*, 5Q0407151J 5Q0407151L
	VW6040J SALINCAK ÖN ALT SOL METAL	Ağırlık : 3,206 kg / 7.068 lb Malzeme Türü : Sac Metal	5Q0407151J*, 5Q0407151J 5Q0407153E
	VW9004 SALINCAK ARKA	Ağırlık : 1,3 kg / 2.866 lb Malzeme Türü : Sac Metal	5Q0505323C, 5Q0505323D
	VW9005 SALINCAK ARKA ALT ÖNDEN	Ağırlık : 0,566 kg / 1.248 lb Malzeme Türü : Sac Metal	5Q0501529C, 5Q0501529D 5Q0501529E, 5Q0501529F
	AU11068 SALINCAK VE DENGE KOLU BURCU ARKA ALT SOL VE SAĞ METAL	Şasi (Ön / Arka) : ARKA Yön : Alt Sol Ve Sağ Ağırlık : 0,201 kg / 0.443 lb Malzeme Türü : Metal	PART OF 5Q0505223D, PART OF 5Q0505224D
	AU11070 SALINCAK VE DENGE KOLU BURCU ARKA ALT	Şasi (Ön / Arka) : ARKA Yön : Alt Ağırlık : 0,100 kg / 0.220 lb	5Q0505171, 5Q0505311C 5Q0505311CSK, 5Q0505311D 5Q0505311DSK
	VW11042 SALINCAK VE DENGE KOLU BURCU ORTA SOL VE SAĞ	Yön : Orta Sol Ve Sağ Ağırlık : 0,182 kg / 0.401 lb	1K0407182, 5Q0407182
	VW11063 SALINCAK VE DENGE KOLU BURCU SOL VE SAĞ	Yön : Sol Ve Sağ Ağırlık : 0.34 kg / 0.750 lb	5Q0407183D, 5Q0407183E
	VW11075 SALINCAK VE DENGE KOLU BURCU ARKA SOL VE SAĞ	Şasi (Ön / Arka) : ARKA Yön : Sol Ve Sağ Ağırlık : 0,870 kg / 1.918 lb Not : FORWARD and INNER	Part of 5Q0501529C, Part of 5Q0501529D Part of 5Q0501529E, Part of 5Q0501529F





* Bu sayfada ve katalogdaki tüm araçların adları, markaları, modelleri, sembolleri, logoları, orjinal numaraları (oe) ve diğer üçüncü parti numaraları sadece referans amaçlı kullanılmaktadır.

OCTAVIA
III 5E3
2012 - 2020





Resim	Ürün Kodu ve Açıklaması	Detay	OEM
	VW11076 SALINCAK VE DENG KOLU BURCU ARKA SOL VE SAĞ	Şasi (Ön / Arka) : ARKA Yön : Sol Ve Sağ Ağırlık : 0,870 kg / 1.918 lb Not : FORWARD and OUTER	Part of 5Q0501529C, Part of 5Q0501529D Part of 5Q0501529E, Part of 5Q0501529F
	VW12159 TAŞIYICI DESTEK BURÇLARI ARKA SOL VE SAĞ	Şasi (Ön / Arka) : ARKA Yön : Sol Ve Sağ Ağırlık : 0,130 kg / 0.287 lb	1K0505553, 1K0505553A
	SK12003 VİRAJ DEMİR LASTİĞİ SOL VE SAĞ RUBBER	Şasi (Ön / Arka) : ÖN Yön : Sol Ve Sağ Ağırlık : 0,075 kg / 0.165 lb Malzeme Türü : Rubber	1K0411303, 1K0411303AL* 1K0411303BK, 1K0411314 3C0411303AA*, 3C0411303T*
	SK12003K VİRAJ DEMİR LASTİĞİ SOL VE SAĞ RUBBER	Şasi (Ön / Arka) : ÖN Yön : Sol Ve Sağ Ağırlık : 0,150 kg / 0.331 lb Malzeme Türü : Rubber	1K0411303, 1K0411303AL* 1K0411303BK, 1K0411314 3C0411303AA*, 3C0411303T*
	AU12019 MOTOR TAKOZU SOL VE SAĞ MOTOR TAKOZU	Yön : Sol Ve Sağ Ağırlık : 0.204 kg / 0.450 lb Malzeme Türü : Motor TakoZu	5Q0198037, 5QD199867
	AU12019K MOTOR TAKOZU SOL VE SAĞ MOTOR TAKOZU TAKIM	Yön : Sol Ve Sağ Ağırlık : 0.408 kg / 0.899 lb Malzeme Türü : Motor TakoZu Takim	5Q0198037
	AU12020 MOTOR TAKOZU SOL VE SAĞ MOTOR TAKOZU	Yön : Sol Ve Sağ Ağırlık : 0.21 kg / 0.463 lb Malzeme Türü : Motor TakoZu	5Q0198037, 5Q0199868 5QD199868
	AU12022 MOTOR TAKOZU SOL VE SAĞ MOTOR TAKOZU	Yön : Sol Ve Sağ Ağırlık : 1.58 kg / 3.483 lb Malzeme Türü : Motor TakoZu	5Q0199262, 5Q0199262BH 5Q0199262DE
	AU12023 MOTOR TAKOZU SOL VE SAĞ MOTOR TAKOZU 7 İLERİ	Yön : Sol Ve Sağ Ağırlık : 1.58 kg / 3.483 lb Malzeme Türü : Motor TakoZu Not : 7 İLERİ	5Q0199262BE, 5Q0199262BF
	AU12026 MOTOR TAKOZU ÖN SOL VE SAĞ	Şasi (Ön / Arka) : ÖN Yön : Sol Ve Sağ Ağırlık : 0,850 kg / 1.874 lb	5Q0199855AD, 5Q0199855J 5Q0199855P, 5Q0199855Q
	SK12005 MOTOR TAKOZU ÖN SAĞ	Şasi (Ön / Arka) : ÖN Yön : Sağ Ağırlık : 1,575 kg / 3.472 lb	5Q0199262CK

* Bu sayfada ve katalogdaki tüm araçların adları, markaları, modelleri, sembolleri, logoları, orjinal numaraları (oe) ve diğer üçüncü parti numaraları sadece referans amaçlı kullanılmaktadır.

OCTAVIA
III 5E3
2012 - 2020











Resim	Ürün Kodu ve Açıklaması	Detay	OEM
	VW12157 MOTOR TAKOZU ÖN SOL VE SAĞ	Şasi (Ön / Arka) : ÖN Yön : Sol Ve Sağ Ağırlık : 2.2 kg / 4.850 lb	5Q0199555AF, 5Q0199555T 5Q01999555AP
	VW12051 SÜSPANSİYON TAKOZU SOL VE SAĞ LASTİK DAYANAK SÜSPANSİYON	Yön : Sol Ve Sağ Ağırlık : 0.045 kg / 0.099 lb Not : LASTİK DAYANAK SÜSPANSİYON	1K0412303B
	VW12086 RADYATÖR TAKOZU SOL VE SAĞ RADYATÖR ÜST LASTİĞİ	Yön : Sol Ve Sağ Ağırlık : 0.024 kg / 0.053 lb Not : RADYATÖR ÜST LASTİĞİ	1K0121367F
	VW13006 DİREKSİYON KÖRÜĞÜ	Ağırlık : 0.145 kg / 0.320 lb	1K0423831A, 5C0423831
	VW13006K DİREKSİYON KÖRÜĞÜ SOL VE SAĞ 2 PİCES	Ağırlık : 0.29 kg / 0.639 lb	1K0423831A, 5C0423831

OCTAVIA
III COMBI 5E5
2012 - 2020

Resim	Ürün Kodu ve Açıklaması	Detay	OEM
	VW1014 ROTİL ÖN ALT SAĞ Ø15,6 RB2536	Ağırlık : 0,565 kg / 1.246 lb Konik Ölçüsü : Ø15,6 Bağlantı Delik Çapı : Ø10,5 Aşık Diş Çapı : M12X1,5	1K0407366B, 1K0407366C 1K0407366E, 5Q0407366A
	VW1015 ROTİL ÖN ALT SOL Ø15,6 RB2537	Ağırlık : 0,565 kg / 1.246 lb Konik Ölçüsü : Ø15,6 Bağlantı Delik Çapı : Ø10,5 Aşık Diş Çapı : M12X1,5	1K0407365B, 1K0407365C 1K0407365E, 5Q0407365A
	VW2009 ROTBAŞI ÖN SOL RD0343	Ağırlık : 0,412 kg / 0.908 lb Uzunluk : 95 mm / 3.74 inch Gövde Diş Çapı : M16X1,5 Aşık Diş Çapı : M12X1,5 Aşık Konik Çapı : Ø13,5	1K0423811A, 1K0423811C 1K0423811E, 1K0423811G 1K0423811J, 1K0423811K 1KD423811A
	SK4005 Z ROT ÖM SAĞ-SOL L=335MM	Ağırlık : 0,322 kg / 0.710 lb Malzeme Türü : Metal Uzunluk : 335 mm / 13.19 inch Aşık Diş Çapı : M12X1,5	5Q0411315B
	VW4031 Z ROT ARKA PLASTİK	Ağırlık : 0,15 kg / 0.331 lb Malzeme Türü : Plastik Uzunluk : 70 mm / 2.76 inch Aşık Diş Çapı : M10X1,5	5Q0505465A, 5Q0505465C

* Bu sayfada ve katalogdaki tüm araçların adları, markaları, modelleri, sembolleri, logoları, orjinal numaraları (oe) ve diğer üçüncü parti numaraları sadece referans amaçlı kullanılmaktadır.

OCTAVIA
III COMBI 5E5
2012 - 2020

Resim	Ürün Kodu ve Açıklaması	Detay	OEM
	AU9009 SALINCAK ALT SOL VE SAĞ	Ağırlık : 2,910 kg / 6.415 lb Malzeme Türü : Sac Metal	5Q0505311C, 5Q0505311D
	AU9012 SALINCAK ARKA ALT SAĞ	Ağırlık : 1,640 kg / 3.616 lb Malzeme Türü : Sac Metal	5Q0505224D
	AU9013 SALINCAK ARKA ALT SOL	Ağırlık : 1,640 kg / 3.616 lb Malzeme Türü : Sac Metal	5Q0505223D
	VW6039 SALINCAK ÖN ALT SAĞ METAL	Ağırlık : 3,763 kg / 8.296 lb Malzeme Türü : Sac Metal	5Q0407152J*, 5Q0407152J 5Q0407152L
	VW6039J SALINCAK ÖN ALT SAĞ METAL	Ağırlık : 3,206 kg / 7.068 lb Malzeme Türü : Sac Metal	5Q0407152J*, 5Q0407152J 5Q0407154E
	VW6040 SALINCAK ÖN ALT SOL METAL	Ağırlık : 3,763 kg / 8.296 lb Malzeme Türü : Sac Metal	5Q0407151J*, 5Q0407151J 5Q0407151L
	VW6040J SALINCAK ÖN ALT SOL METAL	Ağırlık : 3,206 kg / 7.068 lb Malzeme Türü : Sac Metal	5Q0407151J*, 5Q0407151J 5Q0407153E
	VW9004 SALINCAK ARKA	Ağırlık : 1,3 kg / 2.866 lb Malzeme Türü : Sac Metal	5Q0505323C, 5Q0505323D
	VW9005 SALINCAK ARKA ALT ÖNDEN	Ağırlık : 0,566 kg / 1.248 lb Malzeme Türü : Sac Metal	5Q0501529C, 5Q0501529D 5Q0501529E, 5Q0501529F
	AU11068 SALINCAK VE DENGE KOLU BURCU ARKA ALT SOL VE SAĞ METAL	Şasi (Ön / Arka) : ARKA Yön : Alt Sol Ve Sağ Ağırlık : 0,201 kg / 0.443 lb Malzeme Türü : Metal	PART OF 5Q0505223D, PART OF 5Q0505224D
	AU11070 SALINCAK VE DENGE KOLU BURCU ARKA ALT	Şasi (Ön / Arka) : ARKA Yön : Alt Ağırlık : 0,100 kg / 0.220 lb	5Q0505171, 5Q0505311C 5Q0505311CSK, 5Q0505311D 5Q0505311DSK







* Bu sayfada ve katalogdaki tüm araçların adları, markaları, modelleri, sembolleri, logoları, orjinal numaraları (oe) ve diğer üçüncü parti numaraları sadece referans amaçlı kullanılmaktadır.

OCTAVIA
III COMBI 5E5
2012 - 2020

Resim	Ürün Kodu ve Açıklaması	Detay	OEM
	VW11042 SALINCAK VE DENGE KOLU BURCU ORTA SOL VE SAĞ	Yön : Orta Sol Ve Sağ Ağırlık : 0,182 kg / 0.401 lb	1K0407182, 5Q0407182
	VW11063 SALINCAK VE DENGE KOLU BURCU SOL VE SAĞ	Yön : Sol Ve Sağ Ağırlık : 0.34 kg / 0.750 lb	5Q0407183D, 5Q0407183E
	VW11075 SALINCAK VE DENGE KOLU BURCU ARKA SOL VE SAĞ	Şasi (Ön / Arka) : ARKA Yön : Sol Ve Sağ Ağırlık : 0,870 kg / 1.918 lb Not : FORWARD and INNER	Part of 5Q0501529C, Part of 5Q0501529D Part of 5Q0501529E, Part of 5Q0501529F
	VW11076 SALINCAK VE DENGE KOLU BURCU ARKA SOL VE SAĞ	Şasi (Ön / Arka) : ARKA Yön : Sol Ve Sağ Ağırlık : 0,870 kg / 1.918 lb Not : FORWARD and OUTER	Part of 5Q0501529C, Part of 5Q0501529D Part of 5Q0501529E, Part of 5Q0501529F
	VW12159 TAŞIYICI DESTEK BURÇLARI ARKA SOL VE SAĞ	Şasi (Ön / Arka) : ARKA Yön : Sol Ve Sağ Ağırlık : 0,130 kg / 0.287 lb	1K0505553, 1K0505553A
	SK12003 VİRAJ DEMİR LASTİĞİ SOL VE SAĞ RUBBER	Şasi (Ön / Arka) : ÖN Yön : Sol Ve Sağ Ağırlık : 0,075 kg / 0.165 lb Malzeme Türü : Rubber	1K0411303, 1K0411303AL* 1K0411303BK, 1K0411314 3C0411303AA*, 3C0411303T*
	SK12003K VİRAJ DEMİR LASTİĞİ SOL VE SAĞ RUBBER	Şasi (Ön / Arka) : ÖN Yön : Sol Ve Sağ Ağırlık : 0,150 kg / 0.331 lb Malzeme Türü : Rubber	1K0411303, 1K0411303AL* 1K0411303BK, 1K0411314 3C0411303AA*, 3C0411303T*
	AU12019 MOTOR TAKOZU SOL VE SAĞ MOTOR TAKOZU	Yön : Sol Ve Sağ Ağırlık : 0.204 kg / 0.450 lb Malzeme Türü : Motor Takoza	5Q0198037, 5QD199867
	AU12019K MOTOR TAKOZU SOL VE SAĞ MOTOR TAKOZU TAKIM	Yön : Sol Ve Sağ Ağırlık : 0.408 kg / 0.899 lb Malzeme Türü : Motor Takoza Takım	5Q0198037
	AU12020 MOTOR TAKOZU SOL VE SAĞ MOTOR TAKOZU	Yön : Sol Ve Sağ Ağırlık : 0.21 kg / 0.463 lb Malzeme Türü : Motor Takoza	5Q0198037, 5Q0199868 5QD199868
	AU12022 MOTOR TAKOZU SOL VE SAĞ MOTOR TAKOZU	Yön : Sol Ve Sağ Ağırlık : 1.58 kg / 3.483 lb Malzeme Türü : Motor Takoza	5Q0199262, 5Q0199262BH 5Q0199262DE

* Bu sayfada ve katalogdaki tüm araçların adları, markaları, modelleri, sembolleri, logoları, orjinal numaraları (oe) ve diğer üçüncü parti numaraları sadece referans amaçlı kullanılmaktadır.

OCTAVIA
III COMBI 5E5
2012 - 2020

Resim	Ürün Kodu ve Açıklaması	Detay	OEM
	AU12023 MOTOR TAKOZU SOL VE SAĞ MOTOR TAKOZU 7 İLERİ	Yön : Sol Ve Sağ Ağırlık : 1.58 kg / 3.483 lb Malzeme Türü : Motor Takozu Not : 7 İLERİ	5Q0199262BE, 5Q0199262BF
	AU12026 MOTOR TAKOZU ÖN SOL VE SAĞ	Şasi (Ön / Arka) : ÖN Yön : Sol Ve Sağ Ağırlık : 0,850 kg / 1.874 lb	5Q0199855AD, 5Q0199855J 5Q0199855P, 5Q0199855Q
	SK12005 MOTOR TAKOZU ÖN SAĞ	Şasi (Ön / Arka) : ÖN Yön : Sağ Ağırlık : 1,575 kg / 3.472 lb	5Q0199262CK
	VW12157 MOTOR TAKOZU ÖN SOL VE SAĞ	Şasi (Ön / Arka) : ÖN Yön : Sol Ve Sağ Ağırlık : 2.2 kg / 4.850 lb	5Q0199555AF, 5Q0199555T 5Q0199555AP
	VW12051 SÜSPANSİYON TAKOZU SOL VE SAĞ LASTİK DAYANAK SÜSPANSİYON	Yön : Sol Ve Sağ Ağırlık : 0.045 kg / 0.099 lb Not : LASTİK DAYANAK SÜSPANSİYON	1K0412303B
	VW12086 RADYATÖR TAKOZU SOL VE SAĞ RADYATÖR ÜST LASTİĞİ	Yön : Sol Ve Sağ Ağırlık : 0.024 kg / 0.053 lb Not : RADYATÖR ÜST LASTİĞİ	1K0121367F
	VW13006 DİREKSİYON KÖRÜĞÜ	Ağırlık : 0.145 kg / 0.320 lb	1K0423831A, 5C0423831
	VW13006K DİREKSİYON KÖRÜĞÜ SOL VE SAĞ 2 PİCES	Ağırlık : 0.29 kg / 0.639 lb	1K0423831A, 5C0423831

OCTAVIA
IV
2020 -

Resim	Ürün Kodu ve Açıklaması	Detay	OEM
	VW1051 ROTİL ALT SAĞ	Ağırlık : 0,630 kg / 1.389 lb	5Q0407366A, 5Q0407366E
	VW1052 ROTİL ALT SOL	Ağırlık : 0,630 kg / 1.389 lb	5Q0407366E

* Bu sayfada ve katalogdaki tüm araçların adları, markaları, modelleri, sembolleri, logoları, orjinal numaraları (oe) ve diğer üçüncü parti numaraları sadece referans amaçlı kullanılmaktadır.

OCTAVIA
IV
2020 -









Resim	Ürün Kodu ve Açıklaması	Detay	OEM
	VW2031 ROTBAŞI SAĞ	Ağırlık : 0,515 kg / 1.135 lb	5WA423812B, 5WA423812C 5WA423812D
	VW2032 ROTBAŞI SOL	Ağırlık : 0,515 kg / 1.135 lb	5WA423811B, 5WA423811C 5WA423811D
	VW3030 ROTMİLİ ÖN	Ağırlık : 0,655 kg / 1.444 lb Uzunluk : 310 mm / 12.20 inch Gövde Diş Çapı : M16X1,5 Aşık Diş Çapı : M16X1,5	5WA423810C
	VW4035 Z ROT ARKA PLASTİK	Ağırlık : 0,165 kg / 0.364 lb Malzeme Türü : Plastik Uzunluk : 111 mm / 4.37 inch	5WA505465A
	VW6079J SALINCAK VE DENGE KOLU ÖN ALT SAĞ SAC LEVHA	Ağırlık : 3,202 kg / 7.059 lb Malzeme Türü : Sac Metal	5Q0407154E, 5WA407151A 5WA407152A
	VW6080J SALINCAK VE DENGE KOLU ÖN ALT SOL SAC LEVHA	Ağırlık : 3,202 kg / 7.059 lb Malzeme Türü : Sac Metal	5Q0407153E, 5WA407151A 5WA407152A
	VW6089 SALINCAK VE DENGE KOLU ÖN ALT SAĞ SAC LEVHA	Ağırlık : 3,624 kg / 7.990 lb Malzeme Türü : Sac Metal	5WA407152A
	VW6090 SALINCAK VE DENGE KOLU ÖN ALT SOL SAC LEVHA	Ağırlık : 3,624 kg / 7.990 lb Malzeme Türü : Sac Metal	5WA407151A
	VW9012 SALINCAK VE DENGE KOLU ARKA ALT ÖNDEN SAC LEVHA	Ağırlık : 0,675 kg / 1.488 lb Malzeme Türü : Sac Metal	5Q0501529G
	VW11042 SALINCAK VE DENGE KOLU BURCU ORTA SOL VE SAĞ	Yön : Orta Sol Ve Sağ Ağırlık : 0,182 kg / 0.401 lb	1K0407182, 5Q0407182
	VW11183 SALINCAK VE DENGE KOLU BURCU ÖN ALT	Şasi (Ön / Arka) : ÖN Yön : Alt Ağırlık : 0,322 kg / 0.710 lb	5Q0407182F, 5Q0407183D 5Q0407183E, 5Q0407183J 5Q0407183L

* Bu sayfada ve katalogdaki tüm araçların adları, markaları, modelleri, sembolleri, logoları, orjinal numaraları (oe) ve diğer üçüncü parti numaraları sadece referans amaçlı kullanılmaktadır.

OCTAVIA
IV
2020 -

Resim	Ürün Kodu ve Açıklaması	Detay	OEM
	AU11080 BEŞİK (TRAVERS) BURCU ÖN ALT	Şasi (Ön / Arka) : ÖN Yön : Alt Ağırlık : 0,135 kg / 0.298 lb	5Q0505553
	SK12005 MOTOR TAKOZU ÖN SAĞ	Şasi (Ön / Arka) : ÖN Yön : Sağ Ağırlık : 1,575 kg / 3.472 lb	5Q0199262CK

RAPID
NH3
2012 -

Resim	Ürün Kodu ve Açıklaması	Detay	OEM
	SK1025 ROTİL SAĞ	Ağırlık : 0,59 kg / 1.301 lb Konik Ölçüsü : Ø15 Bağlantı Delik Çapı : Ø10,5 Aşık Diş Çapı : M12X1,5	5U0407366A, 6R0407366 6R0407366A, 6R0407366B
	SK1026 ROTİL ÖN ALT SOL Ø15	Ağırlık : 0,59 kg / 1.301 lb Konik Ölçüsü : Ø15 Bağlantı Delik Çapı : Ø10,5 Aşık Diş Çapı : M12X1,5	5U0407365A, 6R0407365 6R0407365A, 6R0407365B
	SK2003 ROTBAŞI SAĞ RC7314	Ağırlık : 0,377 kg / 0.831 lb Uzunluk : 93,5 mm / 3.68 inch Gövde Diş Çapı : M14X1,5 Aşık Diş Çapı : M12X1,5 Aşık Konik Çapı : Ø13,5	5Z0423812, 6Q0419812C 6Q0423812, 6Q0423812A 6Q0423812C, 6Q0423812D 6R0423812, 8Z0423811A
	SK2004 ROTBAŞI SOL RC7313	Ağırlık : 0,382 kg / 0.842 lb Uzunluk : 93 mm / 3.66 inch Gövde Diş Çapı : M14X1,5 Aşık Diş Çapı : M12X1,5 Aşık Konik Çapı : Ø13,5	5Z0423811, 6Q0419811C 6Q0423811, 6Q0423811A 6Q0423811C, 6Q0423811D 6R0423811, 8Z0423812A
	SK2006 ROTBAŞI SAĞ	Ağırlık : 0,420 kg / 0.926 lb Uzunluk : 94 mm / 3.70 inch Gövde Diş Çapı : M14X1,5 Aşık Diş Çapı : M12X1,5 Aşık Konik Çapı : Ø13,3	6C0423812A
	SK2007 ROTBAŞI SOL	Ağırlık : 0,420 kg / 0.926 lb Uzunluk : 94 mm / 3.70 inch Gövde Diş Çapı : M14X1,5 Aşık Diş Çapı : M12X1,5 Aşık Konik Çapı : Ø13,3	6C0423811A
	AU3012 ROTMİLİ SAĞ-SOL M14X1,5 L=312MM	Ağırlık : 0,6 kg / 1.323 lb Uzunluk : 312 mm / 12.28 inch Gövde Diş Çapı : M14X1,5 Aşık Diş Çapı : M14X1,5	6C0423810A, 6C0423810B 6C0423810C
	VW3017 ROTMİLİ ÖN M14X1.5 313	Ağırlık : 0,6 kg / 1.323 lb Uzunluk : 313 mm / 12.32 inch Gövde Diş Çapı : M14X1,5 Aşık Diş Çapı : M14X1,5	6R0423803, 6R0423803C 6R0423804, 6R0423804B 6R0423804C, 6R0423810 8Z0419810C, 8Z0423803

* Bu sayfada ve katalogdaki tüm araçların adları, markaları, modelleri, sembolleri, logoları, orjinal numaraları (oe) ve diğer üçüncü parti numaraları sadece referans amaçlı kullanılmaktadır.

RAPID
NH3
2012 -

Resim	Ürün Kodu ve Açıklaması	Detay	OEM
	SK2003VW3017 ROT TAKIMI ÖN AKS SAĞ	Ağırlık : 1,008 kg / 2.222 lb Rotbaşı : SK2003 Rotmili : VW3017	6R0423804, 6R0423804A 8Z0423804C
	SK2004VW3017 ROT TAKIMI ÖN AKS SOL	Ağırlık : 1,008 kg / 2.222 lb Rotbaşı : SK2004 Rotmili : VW3017	6R0423803, 6R0423803A 8Z0423803C, SK-402923
	AU4028 Z ROT ÖN	Ağırlık : 0,368 kg / 0.811 lb Malzeme Türü : Metal Uzunluk : 270 mm / 10.63 inch Aşık Diş Çapı : M10X1,5	6Q0411315L, 6Q0411315N 8Z0411315D
	SK4004 Z ROT ÖM SAĞ-SOL L=270	Ağırlık : 0,266 kg / 0.586 lb Malzeme Türü : Metal Uzunluk : 270 mm / 10.63 inch	6R0411315
	VW6034 SALINCAK ÖN SAĞ	Ağırlık : 3,495 kg / 7.705 lb Malzeme Türü : Sac Metal	6R0407152A**, 6R0407152A 6R0407152B**, 6R0407152C** 6R0407152C, 6R0407152E 6R0407152F**
	VW6034J SALINCAK ÖN SAĞ	Ağırlık : 3 kg / 6.614 lb Malzeme Türü : Sac Metal	6R0407152A, 6R0407152B 6R0407152C, 6R0407152F
	VW6035 SALINCAK ÖN SOL	Ağırlık : 3,495 kg / 7.705 lb Malzeme Türü : Sac Metal	6R0407151A**, 6R0407151A 6R0407151B**, 6R0407151C** 6R0407151C, 6R0407151E 6R0407151F**
	VW6035J SALINCAK ÖN SOL	Ağırlık : 3,5 kg / 7.716 lb Malzeme Türü : Sac Metal	6R0407151A, 6R0407151B 6R0407151C, 6R0407151F
	AU11002 SALINCAK VE DENGE KOLU BURCU ÖN SOL VE SAĞ B22117	Şasi (Ön / Arka) : ÖN Yön : Sol Ve Sağ Ağırlık : 0,108 kg / 0.238 lb	1J0407181, 1J0407181A
	AU11005 SALINCAK VE DENGE KOLU BURCU ÖN ORTA SOL VE SAĞ B40115	Şasi (Ön / Arka) : ÖN Yön : Orta Sol Ve Sağ Ağırlık : 0,111 kg / 0.245 lb Not : VW6014 - VW60614J	191407182, 357407182 357407182F
	SK11011 TORSİYON BURCU SOL VE SAĞ	Yön : Sol Ve Sağ Ağırlık : 0,346 kg / 0.763 lb	6R0501541A

* Bu sayfada ve katalogdaki tüm araçların adları, markaları, modelleri, sembolleri, logoları, orijinal numaraları (oe) ve diğer üçüncü parti numaraları sadece referans amaçlı kullanılmaktadır.

RAPID
NH3
2012 -







Resim	Ürün Kodu ve Açıklaması	Detay	OEM
	VW12024 VİRAJ DEMİR LASTİĞİ SOL VE SAĞ RUBBER	Şasi (Ön / Arka) : ÖN Yön : Sol Ve Sağ Ağırlık : 0.03 kg / 0.066 lb Malzeme Türü : Rubber Not : VİRAJ LASTİĞİ	6Q0411303AA, 6Q0411303AD 6Q0411305H, 6Q0411314M 6Q0411314Q
	VW12024K VİRAJ DEMİR LASTİĞİ SOL VE SAĞ RUBBER	Şasi (Ön / Arka) : ÖN Yön : Sol Ve Sağ Ağırlık : 0.06 kg / 0.132 lb Malzeme Türü : Rubber Not : VİRAJ LASTİĞİ (İKİLİ)	6Q0411303AA*, 6Q0411303AA 6Q0411303AD*, 6Q0411303AD 6Q0411305H*, 6Q0411305H 6Q0411314M*, 6Q0411314M 6Q0411314Q*, 6Q0411314Q
	VW12050 VİRAJ DEMİR LASTİĞİ SOL VE SAĞ RUBBER	Şasi (Ön / Arka) : ÖN Yön : Sol Ve Sağ Ağırlık : 0.04 kg / 0.088 lb Malzeme Türü : Rubber Not : VİRAJ LASTİĞİ	6Q0411314P
	VW12050K VİRAJ DEMİR LASTİĞİ SOL VE SAĞ RUBBER	Şasi (Ön / Arka) : ÖN Yön : Sol Ve Sağ Ağırlık : 0.08 kg / 0.176 lb Malzeme Türü : Rubber Not : VİRAJ LASTİĞİ (İKİLİ)	6Q0411314P*, 6Q0411314P
	SK12002 AMORTİSÖR TAKOZU ARKA SOL VE SAĞ 1.2 / 1.4TSI / 1.6TDI / 1.2TDI	Şasi (Ön / Arka) : ARKA Yön : Sol Ve Sağ Ağırlık : 0,305 kg / 0.672 lb Not : 1.2 / 1.4TSI / 1.6TDI / 1.2TDI	1J0513353A, 1J0513353B 1J0513353C, 1J0513353G 6QE513353, 6R0513353 6R0513353B
	VW12061 AMORTİSÖR TAKOZU SOL VE SAĞ AMORTİSÖR TAKOZU	Yön : Sol Ve Sağ Ağırlık : 0.27 kg / 0.595 lb Not : AMORTİSÖR TAKOZU	1H0412365A, 1J0412249 1J0412331BS, 1J0412331C
	VW12061A AMORTİSÖR TAKOZU SOL VE SAĞ AMORTİSÖR RULMANI	Yön : Sol Ve Sağ Ağırlık : 0.08 kg / 0.176 lb Not : AMORTİSÖR RULMANI	1J0412249, 1J0412249C 357412249, 357412249A 4503300051, 7201688 7201848, 95VW3K031AA
	VW12061K AMORTİSÖR TAKOZU SOL VE SAĞ 2 PCS	Yön : Sol Ve Sağ Ağırlık : 0.7 kg / 1.543 lb Not : 2 PCS	1H0412365A, 1J0412249 1J0412331BS, 1J0412331C
	VW12103 AMORTİSÖR TAKOZU SOL VE SAĞ AMORTİSÖR ÜST TAKOZU	Yön : Sol Ve Sağ Ağırlık : 0.23 kg / 0.507 lb Not : AMORTİSÖR ÜST TAKOZU	1J0412331B, 1J0412331C
	SE12001 MOTOR TAKOZU ÖN SOL VE SAĞ	Şasi (Ön / Arka) : ÖN Yön : Sol Ve Sağ Ağırlık : 1,360 kg / 2.998 lb	6C0199851J
	SE12003 MOTOR TAKOZU ÖN SOL VE SAĞ	Şasi (Ön / Arka) : ÖN Yön : Sol Ve Sağ Ağırlık : 1,900 kg / 4.189 lb	6C0199167B

* Bu sayfada ve katalogdaki tüm araçların adları, markaları, modelleri, sembolleri, logoları, orijinal numaraları (oe) ve diğer üçüncü parti numaraları sadece referans amaçlı kullanılmaktadır.

RAPID NH3 2012 -

Resim	Ürün Kodu ve Açıklaması	Detay	OEM
	SE12004 MOTOR TAKOZU ÖN SOL VE SAĞ	Şasi (Ön / Arka) : ÖN Yön : Sol Ve Sağ Ağırlık : 1,300 kg / 2.866 lb	6C0199262A
	VW12086 RADYATÖR TAKOZU SOL VE SAĞ RADYATÖR ÜST LASTİĞİ	Yön : Sol Ve Sağ Ağırlık : 0.024 kg / 0.053 lb Not : RADYATÖR ÜST LASTİĞİ	1K0121367F
	AU14001 AKS KÖRÜĞÜ +KELEPÇE+YAĞ.	Ağırlık : 0.233 kg / 0.514 lb	6Q0498203A

RAPID SPACEBACK NH1 2012 -

Resim	Ürün Kodu ve Açıklaması	Detay	OEM
	SK1025 ROTİL SAĞ	Ağırlık : 0,59 kg / 1.301 lb Konik Ölçüsü : Ø15 Bağlantı Delik Çapı : Ø10,5 Aşık Dış Çapı : M12X1,5	5U0407366A, 6R0407366 6R0407366A, 6R0407366B
	SK1026 ROTİL ÖN ALT SOL Ø15	Ağırlık : 0,59 kg / 1.301 lb Konik Ölçüsü : Ø15 Bağlantı Delik Çapı : Ø10,5 Aşık Dış Çapı : M12X1,5	5U0407365A, 6R0407365 6R0407365A, 6R0407365B
	SK2003 ROTBAŞI SAĞ RC7314	Ağırlık : 0,377 kg / 0.831 lb Uzunluk : 93,5 mm / 3.68 inch Gövde Dış Çapı : M14X1,5 Aşık Dış Çapı : M12X1,5 Aşık Konik Çapı : Ø13,5	5Z0423812, 6Q0419812C 6Q0423812, 6Q0423812A 6Q0423812C, 6Q0423812D 6R0423812, 8Z0423811A
	SK2004 ROTBAŞI SOL RC7313	Ağırlık : 0,382 kg / 0.842 lb Uzunluk : 93 mm / 3.66 inch Gövde Dış Çapı : M14X1,5 Aşık Dış Çapı : M12X1,5 Aşık Konik Çapı : Ø13,5	5Z0423811, 6Q0419811C 6Q0423811, 6Q0423811A 6Q0423811C, 6Q0423811D 6R0423811, 8Z0423812A
	SK2006 ROTBAŞI SAĞ	Ağırlık : 0,420 kg / 0.926 lb Uzunluk : 94 mm / 3.70 inch Gövde Dış Çapı : M14X1,5 Aşık Dış Çapı : M12X1,5 Aşık Konik Çapı : Ø13,3	6C0423812A
	SK2007 ROTBAŞI SOL	Ağırlık : 0,420 kg / 0.926 lb Uzunluk : 94 mm / 3.70 inch Gövde Dış Çapı : M14X1,5 Aşık Dış Çapı : M12X1,5 Aşık Konik Çapı : Ø13,3	6C0423811A
	AU3012 ROTMİLİ SAĞ-SOL M14X1,5 L=312MM	Ağırlık : 0,6 kg / 1.323 lb Uzunluk : 312 mm / 12.28 inch Gövde Dış Çapı : M14X1,5 Aşık Dış Çapı : M14X1,5	6C0423810A, 6C0423810B 6C0423810C

* Bu sayfada ve katalogdaki tüm araçların adları, markaları, modelleri, sembolleri, logoları, orjinal numaraları (oe) ve diğer üçüncü parti numaraları sadece referans amaçlı kullanılmaktadır.

RAPID
SPACEBACK NH1
2012 -

Resim	Ürün Kodu ve Açıklaması	Detay	OEM
	VW3017 ROTMİLİ ÖN M14X1.5 313	Ağırlık : 0,6 kg / 1.323 lb Uzunluk : 313 mm / 12.32 inch Gövde Diş Çapı : M14X1,5 Aşık Diş Çapı : M14X1,5	6R0423803, 6R0423803C 6R0423804, 6R0423804B 6R0423804C, 6R0423810 8Z0419810C, 8Z0423803
	SK2003VW3017 ROT TAKIMI ÖN AKS SAĞ	Ağırlık : 1,008 kg / 2.222 lb Rotbaşı : SK2003 Rotmili : VW3017	6R0423804, 6R0423804A 8Z0423804C
	SK2004VW3017 ROT TAKIMI ÖN AKS SOL	Ağırlık : 1,008 kg / 2.222 lb Rotbaşı : SK2004 Rotmili : VW3017	6R0423803, 6R0423803A 8Z0423803C, SK-402923
	AU4028 Z ROT ÖN	Ağırlık : 0,368 kg / 0.811 lb Malzeme Türü : Metal Uzunluk : 270 mm / 10.63 inch Aşık Diş Çapı : M10X1,5	6Q0411315L, 6Q0411315N 8Z0411315D
	SK4004 Z ROT ÖM SAĞ-SOL L=270	Ağırlık : 0,266 kg / 0.586 lb Malzeme Türü : Metal Uzunluk : 270 mm / 10.63 inch	6R0411315
	VW6034 SALINCAK ÖN SAĞ	Ağırlık : 3,495 kg / 7.705 lb Malzeme Türü : Sac Metal	6R0407152A**, 6R0407152A 6R0407152B**, 6R0407152C** 6R0407152C, 6R0407152E 6R0407152F**
	VW6034J SALINCAK ÖN SAĞ	Ağırlık : 3 kg / 6.614 lb Malzeme Türü : Sac Metal	6R0407152A, 6R0407152B 6R0407152C, 6R0407152F
	VW6035 SALINCAK ÖN SOL	Ağırlık : 3,495 kg / 7.705 lb Malzeme Türü : Sac Metal	6R0407151A**, 6R0407151A 6R0407151B**, 6R0407151C** 6R0407151C, 6R0407151E 6R0407151F**
	VW6035J SALINCAK ÖN SOL	Ağırlık : 3,5 kg / 7.716 lb Malzeme Türü : Sac Metal	6R0407151A, 6R0407151B 6R0407151C, 6R0407151F
	AU11002 SALINCAK VE DENGİ KOLU BURCU ÖN SOL VE SAĞ B22117	Şasi (Ön / Arka) : ÖN Yön : Sol Ve Sağ Ağırlık : 0,108 kg / 0.238 lb	1J0407181, 1J0407181A
	AU11005 SALINCAK VE DENGİ KOLU BURCU ÖN ORTA SOL VE SAĞ B40115	Şasi (Ön / Arka) : ÖN Yön : Orta Sol Ve Sağ Ağırlık : 0,111 kg / 0.245 lb Not : VW6014 - VW60614J	191407182, 357407182 357407182F





* Bu sayfada ve katalogdaki tüm araçların adları, markaları, modelleri, sembolleri, logoları, orijinal numaraları (oe) ve diğer üçüncü parti numaraları sadece referans amaçlı kullanılmaktadır.

RAPID
SPACEBACK NH1
2012 -







Resim	Ürün Kodu ve Açıklaması	Detay	OEM
	SK11011 TORSİYON BURCU SOL VE SAĞ	Yön : Sol Ve Sağ Ağırlık : 0,346 kg / 0.763 lb	6R0501541A
	VW12024 VİRAJ DEMİR LASTİĞİ SOL VE SAĞ RUBBER	Şasi (Ön / Arka) : ÖN Yön : Sol Ve Sağ Ağırlık : 0.03 kg / 0.066 lb Malzeme Türü : Rubber Not : VİRAJ LASTİĞİ	6Q0411303AA, 6Q0411303AD 6Q0411305H, 6Q0411314M 6Q0411314Q
	VW12024K VİRAJ DEMİR LASTİĞİ SOL VE SAĞ RUBBER	Şasi (Ön / Arka) : ÖN Yön : Sol Ve Sağ Ağırlık : 0.06 kg / 0.132 lb Malzeme Türü : Rubber Not : VİRAJ LASTİĞİ (İKİLİ)	6Q0411303AA*, 6Q0411303AA 6Q0411303AD*, 6Q0411303AD 6Q0411305H*, 6Q0411305H 6Q0411314M*, 6Q0411314M 6Q0411314Q*, 6Q0411314Q
	VW12050 VİRAJ DEMİR LASTİĞİ SOL VE SAĞ RUBBER	Şasi (Ön / Arka) : ÖN Yön : Sol Ve Sağ Ağırlık : 0.04 kg / 0.088 lb Malzeme Türü : Rubber Not : VİRAJ LASTİĞİ	6Q0411314P
	VW12050K VİRAJ DEMİR LASTİĞİ SOL VE SAĞ RUBBER	Şasi (Ön / Arka) : ÖN Yön : Sol Ve Sağ Ağırlık : 0.08 kg / 0.176 lb Malzeme Türü : Rubber Not : VİRAJ LASTİĞİ (İKİLİ)	6Q0411314P*, 6Q0411314P
	SK12002 AMORTİSÖR TAKOZU ARKA SOL VE SAĞ 1.2 / 1.4TSI / 1.6TDI / 1.2TDI	Şasi (Ön / Arka) : ARKA Yön : Sol Ve Sağ Ağırlık : 0,305 kg / 0.672 lb Not : 1.2 / 1.4TSI / 1.6TDI / 1.2TDI	1J0513353A, 1J0513353B 1J0513353C, 1J0513353G 6QE513353, 6R0513353 6R0513353B
	VW12061 AMORTİSÖR TAKOZU SOL VE SAĞ AMORTİSÖR TAKOZU	Yön : Sol Ve Sağ Ağırlık : 0.27 kg / 0.595 lb Not : AMORTİSÖR TAKOZU	1H0412365A, 1J0412249 1J0412331BS, 1J0412331C
	VW12061A AMORTİSÖR TAKOZU SOL VE SAĞ AMORTİSÖR RULMANI	Yön : Sol Ve Sağ Ağırlık : 0.08 kg / 0.176 lb Not : AMORTİSÖR RULMANI	1J0412249, 1J0412249C 357412249, 357412249A 4503300051, 7201688 7201848, 95VW3K031AA
	VW12061K AMORTİSÖR TAKOZU SOL VE SAĞ 2 PCS	Yön : Sol Ve Sağ Ağırlık : 0.7 kg / 1.543 lb Not : 2 PCS	1H0412365A, 1J0412249 1J0412331BS, 1J0412331C
	VW12103 AMORTİSÖR TAKOZU SOL VE SAĞ AMORTİSÖR ÜST TAKOZU	Yön : Sol Ve Sağ Ağırlık : 0.23 kg / 0.507 lb Not : AMORTİSÖR ÜST TAKOZU	1J0412331B, 1J0412331C
	SE12001 MOTOR TAKOZU ÖN SOL VE SAĞ	Şasi (Ön / Arka) : ÖN Yön : Sol Ve Sağ Ağırlık : 1,360 kg / 2.998 lb	6C0199851J

* Bu sayfada ve katalogdaki tüm araçların adları, markaları, modelleri, sembolleri, logoları, orijinal numaraları (oe) ve diğer üçüncü parti numaraları sadece referans amaçlı kullanılmaktadır.

RAPID
SPACEBACK NH1
2012 -

Resim	Ürün Kodu ve Açıklaması	Detay	OEM
	SE12003 MOTOR TAKOZU ÖN SOL VE SAĞ	Şasi (Ön / Arka) : ÖN Yön : Sol Ve Sağ Ağırlık : 1,900 kg / 4.189 lb	6C0199167B
	SE12004 MOTOR TAKOZU ÖN SOL VE SAĞ	Şasi (Ön / Arka) : ÖN Yön : Sol Ve Sağ Ağırlık : 1,300 kg / 2.866 lb	6C0199262A
	VW12086 RADYATÖR TAKOZU SOL VE SAĞ RADYATÖR ÜST LASTİĞİ	Yön : Sol Ve Sağ Ağırlık : 0.024 kg / 0.053 lb Not : RADYATÖR ÜST LASTİĞİ	1K0121367F
	AU14001 AKS KÖRÜĞÜ +KELEPÇE+YAĞ.	Ağırlık : 0.233 kg / 0.514 lb	6Q0498203A

ROOMSTER
5J
2006 - 2015

Resim	Ürün Kodu ve Açıklaması	Detay	OEM
	SK1025 ROTİL SAĞ	Ağırlık : 0,59 kg / 1.301 lb Konik Ölçüsü : Ø15 Bağlantı Delik Çapı : Ø10,5 Aşık Diş Çapı : M12X1,5	5U0407366A, 6R0407366 6R0407366A, 6R0407366B
	SK1026 ROTİL ÖN ALT SOL Ø15	Ağırlık : 0,59 kg / 1.301 lb Konik Ölçüsü : Ø15 Bağlantı Delik Çapı : Ø10,5 Aşık Diş Çapı : M12X1,5	5U0407365A, 6R0407365 6R0407365A, 6R0407365B
	SK2003 ROTBAŞI SAĞ RC7314	Ağırlık : 0,377 kg / 0.831 lb Uzunluk : 93,5 mm / 3.68 inch Gövde Diş Çapı : M14X1,5 Aşık Diş Çapı : M12X1,5 Aşık Konik Çapı : Ø13,5	5Z0423812, 6Q0419812C 6Q0423812, 6Q0423812A 6Q0423812C, 6Q0423812D 6R0423812, 8Z0423811A
	SK2004 ROTBAŞI SOL RC7313	Ağırlık : 0,382 kg / 0.842 lb Uzunluk : 93 mm / 3.66 inch Gövde Diş Çapı : M14X1,5 Aşık Diş Çapı : M12X1,5 Aşık Konik Çapı : Ø13,5	5Z0423811, 6Q0419811C 6Q0423811, 6Q0423811A 6Q0423811C, 6Q0423811D 6R0423811, 8Z0423812A
	SK3005 ROTMİLİ L = 297	Ağırlık : 0,584 kg / 1.287 lb Uzunluk : 297 mm / 11.69 inch Gövde Diş Çapı : M16X1,5 Aşık Diş Çapı : M14X1,5	6Q0423810C
	SK20033005 ROT TAKIMI ÖN AKS SAĞ	Ağırlık : 0,966 kg / 2.130 lb Rotbaşı : SK2003 Rotmili : SK3005	6Q0419804B, 6Q0423804B 6Q0423804E, 6Q0423804P

* Bu sayfada ve katalogdaki tüm araçların adları, markaları, modelleri, sembolleri, logoları, orjinal numaraları (oe) ve diğer üçüncü parti numaraları sadece referans amaçlı kullanılmaktadır.

ROOMSTER
5J
2006 - 2015

Resim	Ürün Kodu ve Açıklaması	Detay	OEM
	SK20043005 ROT TAKIMI ÖN AKS SOL	Ağırlık : 0,966 kg / 2.130 lb Rotbaşı : SK2004 Rotmili : SK3005	6Q0423803E, 6Q0423803P
	AU4028 Z ROT ÖN	Ağırlık : 0,368 kg / 0.811 lb Malzeme Türü : Metal Uzunluk : 270 mm / 10.63 inch Aşık Diş Çapı : M10X1,5	6Q0411315L, 6Q0411315N 8Z0411315D
	SK4001 Z ROT ÖN METAL	Ağırlık : 0,357 kg / 0.787 lb Malzeme Türü : Metal Uzunluk : 270 mm / 10.63 inch Aşık Diş Çapı : M10X1,5	2Q0411315, 2Q0411315A 6Q0411315A, 6Q0411315E 6Q0411315F, 6Q0411315H 6Q0411315J, 6Q0411315M 6Q0411315P
	SK6013 SALINCAK ÖN ALT SAĞ	Ağırlık : 3,445 kg / 7.595 lb Malzeme Türü : Sac Metal	6R0407152, 6R0407152E
	SK6013J SALINCAK ÖN ALT SAĞ	Ağırlık : 2,88 kg / 6.349 lb Malzeme Türü : Sac Metal	6R0407152
	SK6014 SALINCAK ÖN ALT SOL	Ağırlık : 3,445 kg / 7.595 lb Malzeme Türü : Sac Metal	6R0407151, 6R0407151E
	SK6014J SALINCAK ÖN ALT SOL	Ağırlık : 2,88 kg / 6.349 lb Malzeme Türü : Sac Metal	6R0407151, 6R0407151E
	AU11005 SALINCAK VE DENGE KOLU BURCU ÖN ORTA SOL VE SAĞ B40115	Şasi (Ön / Arka) : ÖN Yön : Orta Sol Ve Sağ Ağırlık : 0,111 kg / 0.245 lb Not : VW6014 - VW60614J	191407182, 357407182 357407182F
	VW11051 SALINCAK VE DENGE KOLU BURCU SOL VE SAĞ	Yön : Sol Ve Sağ Ağırlık : 0.121 kg / 0.267 lb	6Q0407183, 6Q0407183A
	SK11011 TORSİYON BURCU SOL VE SAĞ	Yön : Sol Ve Sağ Ağırlık : 0,346 kg / 0.763 lb	6R0501541A
	VW12066 TORSİYON BURCU SOL VE SAĞ	Yön : Sol Ve Sağ Ağırlık : 0.6 kg / 1.323 lb	1J0 501 541 D, 1J0501541D

* Bu sayfada ve katalogdaki tüm araçların adları, markaları, modelleri, sembolleri, logoları, orjinal numaraları (oe) ve diğer üçüncü parti numaraları sadece referans amaçlı kullanılmaktadır.

ROOMSTER
5J
2006 - 2015

Resim	Ürün Kodu ve Açıklaması	Detay	OEM
	VW12015 VİRAJ DEMİR LASTİĞİ SOL VE SAĞ RUBBER	Şasi (Ön / Arka) : ÖN Yön : Sol Ve Sağ Ağırlık : 0.03 kg / 0.066 lb Malzeme Türü : Rubber Not : VİRAJ DEMİR LASTİĞİ	6Q0411303H, 6Q0411314E 6Q0411314N, 6Q0411314R
	VW12015K VİRAJ DEMİR LASTİĞİ SOL VE SAĞ RUBBER	Şasi (Ön / Arka) : ÖN Yön : Sol Ve Sağ Ağırlık : 0.06 kg / 0.132 lb Malzeme Türü : Rubber Not : VİRAJ LASTİĞİ (İKİLİ)	6Q0411303H*, 6Q0411303H 6Q0411314E*, 6Q0411314E 6Q0411314N*, 6Q0411314N 6Q0411314R*, 6Q0411314R
	SK12002 AMORTİSÖR TAKOZU ARKA SOL VE SAĞ 1.2 / 1.4TSI / 1.6TDI / 1.2TDI	Şasi (Ön / Arka) : ARKA Yön : Sol Ve Sağ Ağırlık : 0.305 kg / 0.672 lb Not : 1.2 / 1.4TSI / 1.6TDI / 1.2TDI	1J0513353A, 1J0513353B 1J0513353C, 1J0513353G 6QE513353, 6R0513353 6R0513353B
	VW12061 AMORTİSÖR TAKOZU SOL VE SAĞ AMORTİSÖR TAKOZU	Yön : Sol Ve Sağ Ağırlık : 0.27 kg / 0.595 lb Not : AMORTİSÖR TAKOZU	1H0412365A, 1J0412249 1J0412331BS, 1J0412331C
	VW12061A AMORTİSÖR TAKOZU SOL VE SAĞ AMORTİSÖR RULMANI	Yön : Sol Ve Sağ Ağırlık : 0.08 kg / 0.176 lb Not : AMORTİSÖR RULMANI	1J0412249, 1J0412249C 357412249, 357412249A 4503300051, 7201688 7201848, 95VW3K031AA
	VW12061K AMORTİSÖR TAKOZU SOL VE SAĞ 2 PCS	Yön : Sol Ve Sağ Ağırlık : 0.7 kg / 1.543 lb Not : 2 PCS	1H0412365A, 1J0412249 1J0412331BS, 1J0412331C
	VW12103 AMORTİSÖR TAKOZU SOL VE SAĞ AMORTİSÖR ÜST TAKOZU	Yön : Sol Ve Sağ Ağırlık : 0.23 kg / 0.507 lb Not : AMORTİSÖR ÜST TAKOZU	1J0412331B, 1J0412331C
	VW12109 AMORTİSÖR TAKOZU SOL VE SAĞ AMORTİSÖR RULMANI	Yön : Sol Ve Sağ Ağırlık : 0.26 kg / 0.573 lb Not : AMORTİSÖR RULMANI	6N0412249C, 6N0412249E
	VW12109K AMORTİSÖR TAKOZU SOL VE SAĞ 2 PCS	Yön : Sol Ve Sağ Ağırlık : 0.52 kg / 1.146 lb Not : 2 PCS	6N0412249C, 6N0412249E
	VW12115 AMORTİSÖR TAKOZU SOL VE SAĞ AMORTİSÖR TAKOZU	Yön : Sol Ve Sağ Ağırlık : 0.85 kg / 1.874 lb Not : AMORTİSÖR TAKOZU	6N0412331D, 6N0412331E 6Q0412331B
	VW12801 AMORTİSÖR TAKOZU SOL VE SAĞ KIT = VW12115 AND VW12109	Yön : Sol Ve Sağ Ağırlık : 1.269 kg / 2.798 lb Not : KIT = VW12115 and VW12109	6N0412249C, 6N0412249E 6N0412331D, 6N0412331E 6Q0412331B

* Bu sayfada ve katalogdaki tüm araçların adları, markaları, modelleri, sembolleri, logoları, orjinal numaraları (oe) ve diğer üçüncü parti numaraları sadece referans amaçlı kullanılmaktadır.

ROOMSTER
5J
2006 - 2015

Resim	Ürün Kodu ve Açıklaması	Detay	OEM
	VW12028 MOTOR TAKOZU SOL VE SAĞ MOTOR TAKOZU	Yön : Sol Ve Sağ Ağırlık : 1.1 kg / 2.425 lb Not : MOTOR TAKOZU	6Q0199851, 6Q0199851AK
	VW12069 MOTOR TAKOZU SOL VE SAĞ MOTOR TAKOZU	Yön : Sol Ve Sağ Ağırlık : 0.83 kg / 1.830 lb Not : MOTOR TAKOZU	6Q0199851AB, 6Q0199851AK
	VW12080 MOTOR TAKOZU SOL VE SAĞ MOTOR TAKOZU	Yön : Sol Ve Sağ Ağırlık : 2.02 kg / 4.453 lb Not : MOTOR TAKOZU	6Q0199167AQ, 6Q0199167BM 6Q0199167BQ, 6Q0199167BR 6Q0199167CA, 6Q0199167CB 6Q0199167CC, 6Q0199167CE 6Q0199167CJ, 6Q0199167CR
	VW12093 MOTOR TAKOZU SOL VE SAĞ MOTOR TAKOZU	Yön : Sol Ve Sağ Ağırlık : 1.05 kg / 2.315 lb Not : MOTOR TAKOZU	6Q0199851AC, 6Q0199851AL 6Q0199851AR, 6Q0199851E 6Q0199851S
	VW12123 MOTOR TAKOZU SOL ŞANZUMAN TAKOZU	Yön : Sol Ağırlık : 1.642 kg / 3.620 lb Malzeme Türü : Şanzuman Takozu	6Q0199555AE, 6Q0199555AT 6R0199555, 6RF199555A 6RF199555C
	VW12086 RADYATÖR TAKOZU SOL VE SAĞ RADYATÖR ÜST LASTİĞİ	Yön : Sol Ve Sağ Ağırlık : 0.024 kg / 0.053 lb Not : RADYATÖR ÜST LASTİĞİ	1K0121367F
	AU14001 AKS KÖRÜĞÜ +KELEPÇE+YAĞ.	Ağırlık : 0.233 kg / 0.514 lb	6Q0498203A
	VW14009 AKS KÖRÜĞÜ +KELEPÇE+YAĞ. DIŞ	Ağırlık : 0.16 kg / 0.353 lb	1H0407285B
	AU15001 AMORTİSÖR KÖRÜĞÜ ÖN	Şasi (Ön / Arka) : ÖN Ağırlık : 0,110 kg / 0.243 lb	6N0413175A

ROOMSTER
PRAKTİK 5J
2007 - 2015

Resim	Ürün Kodu ve Açıklaması	Detay	OEM
	SK1025 ROTİL SAĞ	Ağırlık : 0,59 kg / 1.301 lb Konik Ölçüsü : Ø15 Bağlantı Delik Çapı : Ø10,5 Aşık Dış Çapı : M12X1,5	5U0407366A, 6R0407366 6R0407366A, 6R0407366B

* Bu sayfada ve katalogdaki tüm araçların adları, markaları, modelleri, sembolleri, logoları, orjinal numaraları (oe) ve diğer üçüncü parti numaraları sadece referans amaçlı kullanılmaktadır.

ROOMSTER
PRAKTİK 5J
2007 - 2015

Resim	Ürün Kodu ve Açıklaması	Detay	OEM
	SK1026 ROTİL ÖN ALT SOL Ø15	Ağırlık : 0,59 kg / 1.301 lb Konik Ölçüsü : Ø15 Bağlantı Delik Çapı : Ø10,5 Aşık Diş Çapı : M12X1,5	5U0407365A, 6R0407365 6R0407365A, 6R0407365B
	SK2003 ROTBAŞI SAĞ RC7314	Ağırlık : 0,377 kg / 0.831 lb Uzunluk : 93,5 mm / 3.68 inch Gövde Diş Çapı : M14X1,5 Aşık Diş Çapı : M12X1,5 Aşık Konik Çapı : Ø13,5	5Z0423812, 6Q0419812C 6Q0423812, 6Q0423812A 6Q0423812C, 6Q0423812D 6R0423812, 8Z0423811A
	SK2004 ROTBAŞI SOL RC7313	Ağırlık : 0,382 kg / 0.842 lb Uzunluk : 93 mm / 3.66 inch Gövde Diş Çapı : M14X1,5 Aşık Diş Çapı : M12X1,5 Aşık Konik Çapı : Ø13,5	5Z0423811, 6Q0419811C 6Q0423811, 6Q0423811A 6Q0423811C, 6Q0423811D 6R0423811, 8Z0423812A
	SK3005 ROTMİLİ L = 297	Ağırlık : 0,584 kg / 1.287 lb Uzunluk : 297 mm / 11.69 inch Gövde Diş Çapı : M16X1,5 Aşık Diş Çapı : M14X1,5	6Q0423810C
	SK20033005 ROT TAKIMI ÖN AKS SAĞ	Ağırlık : 0,966 kg / 2.130 lb Rotbaşı : SK2003 Rotmili : SK3005	6Q0419804B, 6Q0423804B 6Q0423804E, 6Q0423804P
	SK20043005 ROT TAKIMI ÖN AKS SOL	Ağırlık : 0,966 kg / 2.130 lb Rotbaşı : SK2004 Rotmili : SK3005	6Q0423803E, 6Q0423803P
	AU4028 Z ROT ÖN	Ağırlık : 0,368 kg / 0.811 lb Malzeme Türü : Metal Uzunluk : 270 mm / 10.63 inch Aşık Diş Çapı : M10X1,5	6Q0411315L, 6Q0411315N 8Z0411315D
	SK6013 SALINCAK ÖN ALT SAĞ	Ağırlık : 3,445 kg / 7.595 lb Malzeme Türü : Sac Metal	6R0407152, 6R0407152E
	SK6013J SALINCAK ÖN ALT SAĞ	Ağırlık : 2,88 kg / 6.349 lb Malzeme Türü : Sac Metal	6R0407152
	SK6014 SALINCAK ÖN ALT SOL	Ağırlık : 3,445 kg / 7.595 lb Malzeme Türü : Sac Metal	6R0407151, 6R0407151E
	SK6014J SALINCAK ÖN ALT SOL	Ağırlık : 2,88 kg / 6.349 lb Malzeme Türü : Sac Metal	6R0407151, 6R0407151E

* Bu sayfada ve katalogdaki tüm araçların adları, markaları, modelleri, sembolleri, logoları, orjinal numaraları (oe) ve diğer üçüncü parti numaraları sadece referans amaçlı kullanılmaktadır.

ROOMSTER
PRAKTİK 5J
2007 - 2015

Resim	Ürün Kodu ve Açıklaması	Detay	OEM
	AU11005 SALINCAK VE DENGE KOLU BURCU ÖN ORTA SOL VE SAĞ B40115	Şasi (Ön / Arka) : ÖN Yön : Orta Sol Ve Sağ Ağırlık : 0,111 kg / 0.245 lb Not : VW6014 - VW60614J	191407182, 357407182 357407182F
	SK11011 TORSİYON BURCU SOL VE SAĞ	Yön : Sol Ve Sağ Ağırlık : 0,346 kg / 0.763 lb	6R0501541A
	VW12015 VİRAJ DEMİR LASTİĞİ SOL VE SAĞ RUBBER	Şasi (Ön / Arka) : ÖN Yön : Sol Ve Sağ Ağırlık : 0.03 kg / 0.066 lb Malzeme Türü : Rubber Not : VİRAJ DEMİR LASTİĞİ	6Q0411303H, 6Q0411314E 6Q0411314N, 6Q0411314R
	VW12015K VİRAJ DEMİR LASTİĞİ SOL VE SAĞ RUBBER	Şasi (Ön / Arka) : ÖN Yön : Sol Ve Sağ Ağırlık : 0.06 kg / 0.132 lb Malzeme Türü : Rubber Not : VİRAJ LASTİĞİ (İKİLİ)	6Q0411303H*, 6Q0411303H 6Q0411314E*, 6Q0411314E 6Q0411314N*, 6Q0411314N 6Q0411314R*, 6Q0411314R
	AU14001 AKS KÖRÜĞÜ +KELEPÇE+YAĞ.	Ağırlık : 0.233 kg / 0.514 lb	6Q0498203A
	VW14009 AKS KÖRÜĞÜ +KELEPÇE+YAĞ. DIŞ	Ağırlık : 0.16 kg / 0.353 lb	1H0407285B
	AU15001 AMORTİSÖR KÖRÜĞÜ ÖN	Şasi (Ön / Arka) : ÖN Ağırlık : 0,110 kg / 0.243 lb	6N0413175A

ROOMSTER
PRAKTİK 5J
2007 -





Resim	Ürün Kodu ve Açıklaması	Detay	OEM
	SK4001 Z ROT ÖN METAL	Ağırlık : 0,357 kg / 0.787 lb Malzeme Türü : Metal Uzunluk : 270 mm / 10.63 inch Aşık Diş Çapı : M10X1,5	2Q0411315, 2Q0411315A 6Q0411315A, 6Q0411315E 6Q0411315F, 6Q0411315H 6Q0411315J, 6Q0411315M 6Q0411315P

SCALA
2019 -

Resim	Ürün Kodu ve Açıklaması	Detay	OEM
	SK12005 MOTOR TAKOZU ÖN SAĞ	Şasi (Ön / Arka) : ÖN Yön : Sağ Ağırlık : 1,575 kg / 3.472 lb	5Q0199262CK

* Bu sayfada ve katalogdaki tüm araçların adları, markaları, modelleri, sembolleri, logoları, orijinal numaraları (oe) ve diğer üçüncü parti numaraları sadece referans amaçlı kullanılmaktadır.

SUPERB
I 3U4
2002 - 2008

Resim	Ürün Kodu ve Açıklaması	Detay	OEM
	AU2214 ROTBAŞI ÖN SAĞ - SOL RB2214	Ağırlık : 0,594 kg / 1.310 lb Uzunluk : 156 mm / 6.14 inch Gövde Diş Çapı : M14X1,5 Aşık Diş Çapı : M8X1,25 Aşık Konik Çapı : Ø17,5	4B0419811B, 4B0419811C 4B0419811E, 4B0419811F 4D0419811A, 4D0419811B 4D0419811G, 4D0419811H 4F0419811E, 4F0498811
	AU2214A ROTBAŞI SAĞ-SOL (KOMPLE DEMİR) RB2225	Ağırlık : 0,597 kg / 1.316 lb Uzunluk : 156 mm / 6.14 inch Gövde Diş Çapı : M14X1,5 Aşık Diş Çapı : M8X1,25 Aşık Konik Çapı : Ø17,4	4B0419811B, 4D0419811A 4D0419811J, 8E0419811B 8E0419811C
	AU2217 ROTBAŞI SAĞ-SOL RB2217	Ağırlık : 0,414 kg / 0.913 lb Uzunluk : 155 mm / 6.10 inch Gövde Diş Çapı : M14X1,5 Aşık Diş Çapı : M8X1,25 Aşık Konik Çapı : Ø17,5	4B0419811G, 4D0419811J 4F0419811C, 4F0419811D 4F0498811, 4F0498811A 8E0419811
	AU3002 ROTMİLİ SAĞ-SOL 144 MM RB2814	Ağırlık : 0,445 kg / 0.981 lb Uzunluk : 130 mm / 5.12 inch Gövde Diş Çapı : M16X1,5 Aşık Diş Çapı : M14X1,5	4B0422821, 4D0422821 4D0422821A

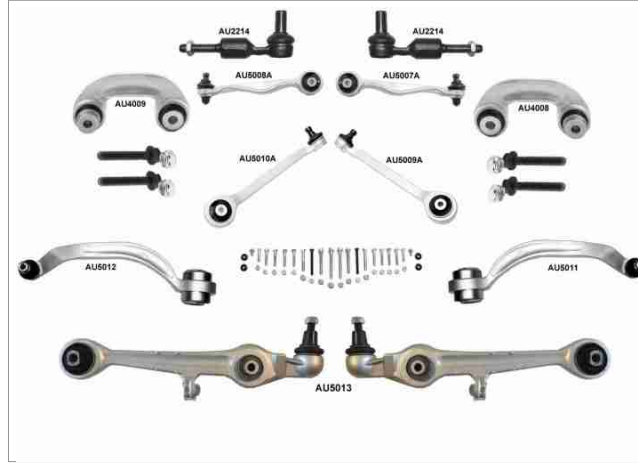









AU8001 / Süspansiyon Kit Ön
SUPERB
I 3U4
2002 - 2008

OEM

8D0498998, 8D0498998-S1

Kit Parçaları









Resim	Ürün Kodu / Adı	OEM	OEM	Ürün Kodu / Adı	Resim
	AU2214 Rotbaşı Ön Sağ - Sol Rb2214	4B0419811B, 4B0419811C 4B0419811E, 4B0419811F 4D0419811A, 4D0419811B 4D0419811G, 4D0419811H 4F0419811E, 4F0498811	4B0419811B, 4B0419811C 4B0419811E, 4B0419811F 4D0419811A, 4D0419811B 4D0419811G, 4D0419811H 4F0419811E, 4F0498811	AU2214 Rotbaşı Ön Sağ - Sol Rb2214	
	AU4008 Z Rot Ön Sağ Alüminyum 90 Rb2921	8D0407318D, 8D0411318D	8D0407317D, 8D0411317D	AU4009 Z Rot Ön Sol Alüminyum 90 Rb2920	
	AU5007A Salıncak Ön Üst Sağ Rb2629	4D0407510B, 4D0407510D 4D0407510F, 4D0407510G 4D0407510H, 4D0407510J 4D0407510K, 8D0407510A 8D0407510C, 8D0407510E	4D0407509F, 4D0407509G 4D0407509J, 4D0407509K 8D0407509C, 8D0407509E 8E0407509A	AU5008A Salıncak Ön Üst Sol Rb2628	
	AU5009A Salıncak Ön Üst Sağ Rb2635	8D0407506A, 8D0407506B 8E0407506A, 8E0407506P	8D0407505A, 8E0407505A 8E0407505P	AU5010A Salıncak Ön Üst Sol Rb2634	
	AU5011 Salıncak Ön Alt Sağ Rb2637	4D0407694AC, 4D0407694AD 4D0407694E, 4D0407694H 4D0407694K, 4D0407694M 4D0407694N, 8E0407694 8E0407694AG, 8E0407694E	4D0407693AC, 4D0407693AD 4D0407693E, 4D0407693H 4D0407693K, 4D0407693M 4D0407693N, 8E0407693 8E0407693AG, 8E0407693E	AU5012 Salıncak Ön Alt Sol Rb2636	
	AU5013 Salıncak Ön Alt Ön Taraf Sol Ve Sağ Alüminyum Rb2616	4B3407151C, 4B3407151E 4D0407151G, 4D0407151H 4D0407151J	4B3407151C, 4B3407151E 4D0407151G, 4D0407151H 4D0407151J	AU5013 Salıncak Ön Alt Ön Taraf Sol Ve Sağ Alüminyum Rb2616	

SUPERB
I 3U4
2002 - 2008

Resim	Ürün Kodu ve Açıklaması	Detay	OEM
	AU22143002 ROT TAKIMI ÖN AKS RB288115	Ağırlık : 1,043 kg / 2.299 lb Rotbaşı : AU2214 Rotmilii : AU3002	1J0422812A, 4B0419801B 4B0419801E, 4B0419801M 4D0419801B, 4D0419801C 4D0419801D, 4D0419801L
	AU2214A3002 ROT TAKIMI ÖN AKS RB288136	Ağırlık : 1,026 kg / 2.262 lb Rotbaşı : AU2214 Rotmilii : AU3002	4B0419801G, 4B0419801N 4D0419801Q, 8E0419801B
	AU4008 Z ROT ÖN SAĞ ALİMİNYUM 90 RB2921	Ağırlık : 0,347 kg / 0.765 lb Malzeme Türü : Alüminyum Uzunluk : 90 mm / 3.54 inch	8D0407318D, 8D0411318D
	AU4009 Z ROT ÖN SOL ALİMİNYUM 90 RB2920	Ağırlık : 0,347 kg / 0.765 lb Malzeme Türü : Alüminyum Uzunluk : 90 mm / 3.54 inch	8D0407317D, 8D0411317D
	AU5007A SALINCAK ÖN ÜST SAĞ RB2629	Ağırlık : 0,460 kg / 1.014 lb Malzeme Türü : Alüminyum	4D0407510B, 4D0407510D 4D0407510F, 4D0407510G 4D0407510H, 4D0407510J 4D0407510K, 8D0407510A 8D0407510C, 8D0407510E
	AU5008A SALINCAK ÖN ÜST SOL RB2628	Ağırlık : 0,460 kg / 1.014 lb Malzeme Türü : Alüminyum	4D0407509F, 4D0407509G 4D0407509J, 4D0407509K 8D0407509C, 8D0407509E 8E0407509A
	AU5009 SALINCAK ÖN ÜST SAĞ RB2630	Malzeme Türü : Alüminyum	8D0407506B, 8D0407506F 8D0407506H, 8D0407506K
	AU5009A SALINCAK ÖN ÜST SAĞ RB2635	Ağırlık : 0,488 kg / 1.076 lb Malzeme Türü : Alüminyum	8D0407506A, 8D0407506B 8E0407506A, 8E0407506P
	AU5010 SALINCAK ÖN ÜST SOL RB2631	Malzeme Türü : Alüminyum	8D0407505B, 8D0407505F 8D0407505H, 8D0407505K
	AU5010A SALINCAK ÖN ÜST SOL RB2634	Ağırlık : 0,488 kg / 1.076 lb Malzeme Türü : Alüminyum	8D0407505A, 8E0407505A 8E0407505P
	AU5011 SALINCAK ÖN ALT SAĞ RB2637	Ağırlık : 1,750 kg / 3.858 lb Malzeme Türü : Alüminyum	4D0407694AC, 4D0407694AD 4D0407694E, 4D0407694H 4D0407694K, 4D0407694M 4D0407694N, 8E0407694 8E0407694AG, 8E0407694E





* Bu sayfada ve katalogdaki tüm araçların adları, markaları, modelleri, sembolleri, logoları, orjinal numaraları (oe) ve diğer üçüncü parti numaraları sadece referans amaçlı kullanılmaktadır.

SUPERB
I 3U4
2002 - 2008

Resim	Ürün Kodu ve Açıklaması	Detay	OEM
	AU5012 SALINCAK ÖN ALT SOL RB2636	Ağırlık : 1,800 kg / 3.968 lb Malzeme Türü : Alüminyum	4D0407693AC, 4D0407693AD 4D0407693E, 4D0407693H 4D0407693K, 4D0407693M 4D0407693N, 8E0407693 8E0407693AG, 8E0407693E
	AU5013 SALINCAK ÖN ALT ÖN TARAF SOL VE SAĞ ALÜMİNYUM RB2616	Ağırlık : 1,520 kg / 3.351 lb Malzeme Türü : Alüminyum	4B3407151C, 4B3407151E 4D0407151G, 4D0407151H 4D0407151J
	AU5013B SALINCAK ÖN ALT ÖN TARAF SOL VE SAĞ ALÜMİNYUM RB2641	Ağırlık : 1,500 kg / 3.307 lb Malzeme Türü : Alüminyum	4B3407151C, 4B3407151K
	AU5085 SALINCAK ÖN ÜST ÖNDEN SAĞ	Ağırlık : 0,515 kg / 1.135 lb Malzeme Türü : Alüminyum	8E0407506P
	AU5086 SALINCAK ÖN ÜST ÖNDEN SOL	Ağırlık : 0,515 kg / 1.135 lb Malzeme Türü : Alüminyum	8E0407505P
	AU5087 SALINCAK ÖN ÜST ARKADAN SAĞ	Ağırlık : 248,3 kg / 547.408 lb Malzeme Türü : Alüminyum	8E0407510P
	AU5088 SALINCAK ÖN ÜST ARKADAN SOL	Ağırlık : 248,3 kg / 547.408 lb Malzeme Türü : Alüminyum	8E0407509P
	AU11003 SALINCAK VE DENGE KOLU BURCU ÖN ÜST SOL VE SAĞ B22115	Şasi (Ön / Arka) : ÖN Yön : Üst Sol Ve Sağ Ağırlık : 0,075 kg / 0.165 lb	4B0407515, 4B0407515A 4D0407515C*, 4D0407515C
	AU11006 SALINCAK VE DENGE KOLU BURCU ÖN SOL VE SAĞ	Şasi (Ön / Arka) : ÖN Yön : Sol Ve Sağ Ağırlık : 0,225 kg / 0.496 lb	4D0407182E, 4D0407182G 8E0407182A, 8E0407182E
	AU11007 SALINCAK VE DENGE KOLU BURCU ÖN ALT SOL VE SAĞ	Şasi (Ön / Arka) : ÖN Yön : Alt Sol Ve Sağ Ağırlık : 0,59 kg / 1.301 lb	4D0407183AB, 4D0407183AC 4D0407183D, 4D0407183M 4D0407183N, 4D0407183P 4D0407183S
	AU11033 SALINCAK VE DENGE KOLU BURCU ÖN ALT SOL VE SAĞ B22135	Şasi (Ön / Arka) : ÖN Yön : Alt Sol Ve Sağ Ağırlık : 0,072 kg / 0.159 lb	8E0407181B, 8E0407181C 8E0407181D











* Bu sayfada ve katalogdaki tüm araçların adları, markaları, modelleri, sembolleri, logoları, orjinal numaraları (oe) ve diğer üçüncü parti numaraları sadece referans amaçlı kullanılmaktadır.

SUPERB
I 3U4
2002 - 2008

Resim	Ürün Kodu ve Açıklaması	Detay	OEM
	VW11052 SALINCAK VE DENGE KOLU BURCU ALT SOL VE SAĞ B22130	Yön : Alt Sol Ve Sağ Ağırlık : 0,523 kg / 1.153 lb	4D0407183M, 4D0407183N 4D0407183P, 4D0407183Q 4E0407183M
	AU11091 ROTMİLİ BURCU VE LASTİĞİ		4B0419811E*, 4B0419811F* 4D0419811A*, 4D0419811B* 4F0419811B*, 4F0419811E* 4F0498811*, 8E0419811B*
	AU12029 ROTMİLİ BURCU VE LASTİĞİ ÖN	Şasi (Ön / Arka) : ÖN	171419804*, 171419804A* 175419804*
	AU12029K ROTMİLİ BURCU VE LASTİĞİ ÖN	Şasi (Ön / Arka) : ÖN	171419804*, 171419804A* 175419804*
	AU12005 VİRAJ DEMİR LASTİĞİ SOL VE SAĞ RUBBER	Şasi (Ön / Arka) : ÖN Yön : Sol Ve Sağ Ağırlık : 0.06 kg / 0.132 lb Malzeme Türü : Rubber	4D0411327F, 4D0411327H
	AU12005K VİRAJ DEMİR LASTİĞİ SOL VE SAĞ RUBBER	Şasi (Ön / Arka) : ÖN Yön : Sol Ve Sağ Ağırlık : 0.12 kg / 0.265 lb Malzeme Türü : Rubber	4D0411327F, 4D0411327H
	VW12087 VİRAJ DEMİR LASTİĞİ SOL VE SAĞ RUBBER	Şasi (Ön / Arka) : ÖN Yön : Sol Ve Sağ Ağırlık : 0.059 kg / 0.130 lb Malzeme Türü : Rubber Not : VİRAJ LASTİĞİ	4D0411327E, 4D0411327G
	VW12087K VİRAJ DEMİR LASTİĞİ SOL VE SAĞ RUBBER	Şasi (Ön / Arka) : ÖN Yön : Sol Ve Sağ Ağırlık : 0.118 kg / 0.260 lb Malzeme Türü : Rubber	4D0411327E*, 4D0411327G*
	SK12001 AMORTİSÖR TAKOZU ARKA SOL VE SAĞ	Şasi (Ön / Arka) : ARKA Yön : Sol Ve Sağ Ağırlık : 0.55 kg / 1.213 lb	3B0513353
	AU12033 MOTOR TAKOZU ÖN	Şasi (Ön / Arka) : ÖN Ağırlık : 0,825 kg / 1.819 lb	4B0199379A, 4B0199379E
	VW12031 MOTOR TAKOZU SOL VE SAĞ MOTOR TAKOZU	Yön : Sol Ve Sağ Ağırlık : 0.831 kg / 1.832 lb Not : Motor takoZu	8D0199379K

* Bu sayfada ve katalogdaki tüm araçların adları, markaları, modelleri, sembolleri, logoları, orjinal numaraları (oe) ve diğer üçüncü parti numaraları sadece referans amaçlı kullanılmaktadır.

SUPERB
I 3U4
2002 - 2008

Resim	Ürün Kodu ve Açıklaması	Detay	OEM
	VW12039 MOTOR TAKOZU SOL VE SAĞ MOTOR TAKOZU	Yön : Sol Ve Sağ Ağırlık : 0.816 kg / 1.799 lb Not : MOTOR TAKOZU	8D0199379C, 8D0199382AC 8D0199382AE, 8D0199382AP 8D0199382AR, 8D0199382C 8D0199382G, 8D0199382K 8D0199382M, 8D0199382S
	VW12071 MOTOR TAKOZU SOL VE SAĞ MOTOR TAKOZU	Yön : Sol Ve Sağ Ağırlık : 0.475 kg / 1.047 lb Not : MOTOR TAKOZU	8D0399151H
	AU12035 ŞANZIMAN TAKOZU	Ağırlık : 0,490 kg / 1.080 lb	4B0399151L, 4B0399151M 8E0399151D
	VW12041 ŞANZIMAN TAKOZU SOL VE SAĞ ŞANZIMAN TAKOZU	Yön : Sol Ve Sağ Ağırlık : 0.307 kg / 0.677 lb Not : ŞANZIMAN TAKOZU	8D0399151J, 8D0399151P
	AU12006 SÜSPANSİYON TAKOZU ARKA SOL VE SAĞ	Şasi (Ön / Arka) : ARKA Yön : Sol Ve Sağ Ağırlık : 0.55 kg / 1.213 lb	1J0 512 131 B, 1J0 513 025 Q 1J0512131B, 1J0513025Q
	VW13001 DİREKSİYON KÖRÜĞÜ	Ağırlık : 0.065 kg / 0.143 lb	4D0419831
	VW13009 DİREKSİYON KÖRÜĞÜ	Ağırlık : 0.19 kg / 0.419 lb	8D0419831J, 8D0419831K
	VW14001 AKS KÖRÜĞÜ +KELEPÇE+YAĞ. DIŞ	Ağırlık : 0.14 kg / 0.309 lb	441 407 203A, 441407203A
	VW14003 AKS KÖRÜĞÜ +KELEPÇE+YAĞ. DIŞ	Ağırlık : 0.25 kg / 0.551 lb	1K0 498 203, 1K0498203
	VW14008 AKS KÖRÜĞÜ +KELEPÇE+YAĞ. DIŞ		3B0407203A
	VW14012 AKS KÖRÜĞÜ +KELEPÇE+YAĞ. DIŞ	Ağırlık : 0.175 kg / 0.386 lb	3B0498203A, 4A0498203C 8D0498203A











* Bu sayfada ve katalogdaki tüm araçların adları, markaları, modelleri, sembolleri, logoları, orjinal numaraları (oe) ve diğer üçüncü parti numaraları sadece referans amaçlı kullanılmaktadır.

SUPERB
II 3T4
2008 - 2015

Resim	Ürün Kodu ve Açıklaması	Detay	OEM
	VW1014 ROTİL ÖN ALT SAĞ Ø15,6 RB2536	Ağırlık : 0,565 kg / 1.246 lb Konik Ölçüsü : Ø15,6 Bağlantı Delik Çapı : Ø10,5 Aşık Diş Çapı : M12X1,5	1K0407366B, 1K0407366C 1K0407366E, 5Q0407366A
	VW1015 ROTİL ÖN ALT SOL Ø15,6 RB2537	Ağırlık : 0,565 kg / 1.246 lb Konik Ölçüsü : Ø15,6 Bağlantı Delik Çapı : Ø10,5 Aşık Diş Çapı : M12X1,5	1K0407365B, 1K0407365C 1K0407365E, 5Q0407365A
	VW2008 ROTBAŞI ÖN SAĞ RD0342	Ağırlık : 0,412 kg / 0.908 lb Uzunluk : 95 mm / 3.74 inch Gövde Diş Çapı : M16X1,5 Aşık Diş Çapı : M12X1,5 Aşık Konik Çapı : Ø12,7	1K0423812A, 1K0423812C 1K0423812E, 1K0423812G 1K0423812J, 1K0423812K 1KD423812A
	VW2009 ROTBAŞI ÖN SOL RD0343	Ağırlık : 0,412 kg / 0.908 lb Uzunluk : 95 mm / 3.74 inch Gövde Diş Çapı : M16X1,5 Aşık Diş Çapı : M12X1,5 Aşık Konik Çapı : Ø13,5	1K0423811A, 1K0423811C 1K0423811E, 1K0423811G 1K0423811J, 1K0423811K 1KD423811A
	VW3009 ROTMİLİ SAĞ-SOL 310 RB2838	Ağırlık : 0,665 kg / 1.466 lb Uzunluk : 311 mm / 12.24 inch Gövde Diş Çapı : M16X1,5 Aşık Diş Çapı : M16X1,5	1K0423810A
	VW20083009 ROT TAKIMI ÖN AKS SAĞ RB288137	Ağırlık : 1,078 kg / 2.377 lb Rotbaşı : VW2008 Rotmilî : VW3009	
	VW20093009 ROT TAKIMI ÖN SOL RB288138	Ağırlık : 1,077 kg / 2.374 lb Rotbaşı : VW2009 Rotmilî : VW3009	
	SK4005 Z ROT ÖM SAĞ-SOL L=335MM	Ağırlık : 0,322 kg / 0.710 lb Malzeme Türü : Metal Uzunluk : 335 mm / 13.19 inch Aşık Diş Çapı : M12X1,5	5Q0411315B
	VW4014 Z ROT ÖN SAĞ-SOL METAL 335 RB2935	Ağırlık : 0,46 kg / 1.014 lb Malzeme Türü : Metal Uzunluk : 335 mm / 13.19 inch Aşık Diş Çapı : M12X1,5	1K0411315B, 1K0411315D 1K0411315J, 1K0411315K 1K0411315R, 5Q0411315A 5Q0411315B
	VW4015 Z ROT SOL VE SAĞ METAL RB2937	Ağırlık : 0,373 kg / 0.822 lb Malzeme Türü : Metal Uzunluk : 95,5 mm / 3.76 inch Aşık Diş Çapı : M10X1,5	1K0505465C, 1K0505465D 1K0505465H, 1K0505465J 1K0505465K
	VW4015K Z ROT SOL VE SAĞ METAL	Ağırlık : 0,373 kg / 0.822 lb Malzeme Türü : Metal Uzunluk : 95,5 mm / 3.76 inch Aşık Diş Çapı : M10X1,5	1K0505465C, 1K0505465D 1K0505465H, 1K0505465J 1K0505465K











* Bu sayfada ve katalogdaki tüm araçların adları, markaları, modelleri, sembolleri, logoları, orjinal numaraları (oe) ve diğer üçüncü parti numaraları sadece referans amaçlı kullanılmaktadır.

SUPERB
II 3T4
2008 - 2015

Resim	Ürün Kodu ve Açıklaması	Detay	OEM
	AU6010 SALINCAK ÜST SOL VE SAĞ RA5155	Ağırlık : 1,298 kg / 2.862 lb Malzeme Türü : Sac Metal	1K0505323H, 1K0505323N
	SE9001 SALINCAK ALT SAĞ RA5150	Ağırlık : 1 kg / 2.205 lb Malzeme Türü : Sac Metal	1K0501530C
	SE9002 SALINCAK ALT SOL RA5151	Ağırlık : 1 kg / 2.205 lb Malzeme Türü : Sac Metal	1K0501529F
	SK6011 SALINCAK ÖN ALT SAĞ RD10230	Ağırlık : 4,264 kg / 9.401 lb Malzeme Türü : Sac Metal	1K0407152B**, 1K0407152BC**
	SK6011J SALINCAK ÖN ALT SAĞ RD10232	Ağırlık : 3,691 kg / 8.137 lb Malzeme Türü : Sac Metal	1K0407152B, 1K0407152BC
	SK6012 SALINCAK ÖN ALT SOL RD10231	Ağırlık : 4,264 kg / 9.401 lb Malzeme Türü : Sac Metal	1K0407151BC**, 1K0407151H**
	SK6012J SALINCAK ÖN ALT SOL RD10233	Ağırlık : 3,691 kg / 8.137 lb Malzeme Türü : Sac Metal	1K0407151BC, 1K0407151H
	VW9002 SALINCAK ÖN TARAF SAĞ	Ağırlık : 1,79 kg / 3.946 lb Malzeme Türü : Sac Metal	1K0505224E, 1K0505224H 1K0505224K
	VW9003 SALINCAK ÖN TARAF SOL	Ağırlık : 1,79 kg / 3.946 lb Malzeme Türü : Sac Metal	1K0505223E, 1K0505223H 1K0505223K
	AU11014 SALINCAK VE DENGE KOLU BURCU ARKA SOL VE SAĞ	Şasi (Ön / Arka) : ARKA Yön : Sol Ve Sağ Ağırlık : 0.192 kg / 0.423 lb	1K0505543A
	AU11088 SALINCAK VE DENGE KOLU BURCU ARKA	Şasi (Ön / Arka) : ARKA Ağırlık : 0,165 kg / 0.364 lb	1K0505541C, 1K0505541D 3C0505541

* Bu sayfada ve katalogdaki tüm araçların adları, markaları, modelleri, sembolleri, logoları, orjinal numaraları (oe) ve diğer üçüncü parti numaraları sadece referans amaçlı kullanılmaktadır.

SUPERB
II 3T4
2008 - 2015

Resim	Ürün Kodu ve Açıklaması	Detay	OEM
	VW11037 SALINCAK VE DENGE KOLU BURCU SOL VE SAĞ	Yön : Sol Ve Sağ Ağırlık : 0.11 kg / 0.243 lb	1K0505279A
	VW11042 SALINCAK VE DENGE KOLU BURCU ORTA SOL VE SAĞ	Yön : Orta Sol Ve Sağ Ağırlık : 0,182 kg / 0.401 lb	1K0407182, 5Q0407182
	VW11043 SALINCAK VE DENGE KOLU BURCU SAĞ B22141	Yön : Sağ Diğer Taraf : VW11044 Ağırlık : 0,659 kg / 1.453 lb	1K0199232G, 1K0199232H 1K0199232J
	VW11043B SALINCAK VE DENGE KOLU BURCU SAĞ	Yön : Sağ Diğer Taraf : VW11044B Ağırlık : 0,659 kg / 1.453 lb Not : İÇ BURÇSUZ	1K0199232G, 1K0199232H 1K0199232J
	VW11044 SALINCAK VE DENGE KOLU BURCU SOL B22142	Yön : Sol Diğer Taraf : VW11043 Ağırlık : 0,678 kg / 1.495 lb	1K0199231G, 1K0199231H 1K0199231J
	VW11044B SALINCAK VE DENGE KOLU BURCU SOL	Yön : Sol Diğer Taraf : VW11043B Ağırlık : 0,678 kg / 1.495 lb Not : İÇ BURÇSUZ	1K0199231G, 1K0199231H 1K0199231J
	VW11051 SALINCAK VE DENGE KOLU BURCU SOL VE SAĞ	Yön : Sol Ve Sağ Ağırlık : 0.121 kg / 0.267 lb	6Q0407183, 6Q0407183A
	VW11056 SALINCAK VE DENGE KOLU BURCU ARKA SOL VE SAĞ	Şasi (Ön / Arka) : ARKA Yön : Sol Ve Sağ Ağırlık : 0.13 kg / 0.287 lb	1K0505203A, 1K0505323D 1K0505323G, 1K0505323H 1K0505323N, 5Q0505323C
	VW11180 Z-ROT BURCU ARKA	Şasi (Ön / Arka) : ARKA Ağırlık : 0.069 kg / 0.152 lb Uzunluk : VW4015 mm / 0.00 inch Aşık Diş Çapı : VW4015K	1K0505465C*, 1K0505465D* 1K0505465H*, 1K0505465J* 1K0505465K*
	VW12159 TAŞIYICI DESTEK BURÇLARI ARKA SOL VE SAĞ	Şasi (Ön / Arka) : ARKA Yön : Sol Ve Sağ Ağırlık : 0,130 kg / 0.287 lb	1K0505553, 1K0505553A
	AU12024 TORSİYON BURCU ARKA SOL VE SAĞ	Şasi (Ön / Arka) : ARKA Yön : Sol Ve Sağ Ağırlık : 0.557 kg / 1.228 lb	1K0505145F, 1K0505145H 1K0505145K

* Bu sayfada ve katalogdaki tüm araçların adları, markaları, modelleri, sembolleri, logoları, orjinal numaraları (oe) ve diğer üçüncü parti numaraları sadece referans amaçlı kullanılmaktadır.

SUPERB
II 3T4
2008 - 2015

Resim	Ürün Kodu ve Açıklaması	Detay	OEM
	SK12003 VİRAJ DEMİR LASTİĞİ SOL VE SAĞ RUBBER	Şasi (Ön / Arka) : ÖN Yön : Sol Ve Sağ Ağırlık : 0,075 kg / 0.165 lb Malzeme Türü : Rubber	1K0411303, 1K0411303AL* 1K0411303BK, 1K0411314 3C0411303AA*, 3C0411303T*
	SK12003K VİRAJ DEMİR LASTİĞİ SOL VE SAĞ RUBBER	Şasi (Ön / Arka) : ÖN Yön : Sol Ve Sağ Ağırlık : 0,150 kg / 0.331 lb Malzeme Türü : Rubber	1K0411303, 1K0411303AL* 1K0411303BK, 1K0411314 3C0411303AA*, 3C0411303T*
	VW12137 VİRAJ DEMİR LASTİĞİ	Şasi (Ön / Arka) : ARKA Ağırlık : 0,070 kg / 0.154 lb Not : Ø17mm	1K0511327AQ
	VW12137K VİRAJ DEMİR LASTİĞİ	Şasi (Ön / Arka) : ARKA Ağırlık : 0,140 kg / 0.309 lb Not : KIT	1K0511327AQ
	VW12017 AMORTİSÖR TAKOZU SOL VE SAĞ AMORTİSÖR TAKOZU	Yön : Sol Ve Sağ Ağırlık : 0.847 kg / 1.867 lb Not : AMORTİSÖR TAKOZU	1K0412331B, 1K0412331C
	VW12109 AMORTİSÖR TAKOZU SOL VE SAĞ AMORTİSÖR RULMANI	Yön : Sol Ve Sağ Ağırlık : 0.26 kg / 0.573 lb Not : AMORTİSÖR RULMANI	6N0412249C, 6N0412249E
	VW12109K AMORTİSÖR TAKOZU SOL VE SAĞ 2 PCS	Yön : Sol Ve Sağ Ağırlık : 0.52 kg / 1.146 lb Not : 2 PCS	6N0412249C, 6N0412249E
	VW12027 MOTOR TAKOZU SOL VE SAĞ MOTOR KULAĞI	Yön : Sol Ve Sağ Ağırlık : 2.02 kg / 4.453 lb Not : MOTOR KULAĞI	1K0199262, 1K0199262CN
	VW12029 MOTOR TAKOZU SOL VE SAĞ MOTOR TAKOZU	Yön : Sol Ve Sağ Ağırlık : 0.585 kg / 1.290 lb Not : Motor takozu	1K0199855AD, 1K0199855BA 1K0199855K
	VW12034 MOTOR TAKOZU SOL VE SAĞ MOTOR TAKOZU	Yön : Sol Ve Sağ Ağırlık : 1.9 kg / 4.189 lb Not : Motor takozu	1K0199555BA, 1K0199555BB 1K0199555L, 1K0199555M 1L0199555L
	VW12076 MOTOR TAKOZU SOL VE SAĞ MOTOR TAKOZU	Yön : Sol Ve Sağ Ağırlık : 1.97 kg / 4.343 lb Not : MOTOR TAKOZU	1K0199262AF, 1K0199262AT 1K0199262BB





* Bu sayfada ve katalogdaki tüm araçların adları, markaları, modelleri, sembolleri, logoları, orijinal numaraları (oe) ve diğer üçüncü parti numaraları sadece referans amaçlı kullanılmaktadır.

SUPERB
II 3T4
2008 - 2015

Resim	Ürün Kodu ve Açıklaması	Detay	OEM
	VW12077 MOTOR TAKOZU SOL VE SAĞ MOTOR TAKOZU	Yön : Sol Ve Sağ Ağırlık : 1.95 kg / 4.299 lb Not : MOTOR TAKOZU	1K0199262CG, 1K0199262CP
	VW12082 MOTOR TAKOZU SOL VE SAĞ MOTOR TAKOZU	Yön : Sol Ve Sağ Ağırlık : 2.05 kg / 4.519 lb Not : MOTOR TAKOZU	1K0199262AK, 1K0199262K
	VW12097 MOTOR TAKOZU SOL VE SAĞ MOTOR TAKOZU	Yön : Sol Ve Sağ Ağırlık : 0.251 kg / 0.553 lb Not : MOTOR TAKOZU	1K0199868, 1K0199868A 1K0199868C, 1K0199868P 1K0199868Q
	VW12110 MOTOR TAKOZU SOL VE SAĞ MOTOR TAKOZU	Yön : Sol Ve Sağ Ağırlık : 1.918 kg / 4.228 lb Not : MOTOR TAKOZU	1K0199262AB, 1K0199262AM 1K0199262M
	VW12124 MOTOR TAKOZU SOL VE SAĞ	Yön : Sol Ve Sağ Ağırlık : 1.927 kg / 4.248 lb	1K0199262A, 1K0199262AA 1K0199262AS
	VW12106 ŞANZIMAN TAKOZU SOL ŞANZUMAN TAKOZU SOL	Yön : Sol Ağırlık : 1.95 kg / 4.299 lb Not : ŞANZUMAN TAKOZU SOL	1K0199555AT, 1K0199555T
	VW12038 SÜSPANSİYON TAKOZU SOL VE SAĞ SUS. ARA YATAK TAKOZ ARKA	Yön : Sol Ve Sağ Ağırlık : 0.12 kg / 0.265 lb Not : SUS. ARA YATAK TAKOZ ARKA	3C0 511 359, 3C0511359
	VW12051 SÜSPANSİYON TAKOZU SOL VE SAĞ LASTİK DAYANAK SUSPENSİYON	Yön : Sol Ve Sağ Ağırlık : 0.045 kg / 0.099 lb Not : LASTİK DAYANAK SUSPENSİYON	1K0412303B
	VW12086 RADYATÖR TAKOZU SOL VE SAĞ RADYATÖR ÜST LASTİĞİ	Yön : Sol Ve Sağ Ağırlık : 0.024 kg / 0.053 lb Not : RADYATÖR ÜST LASTİĞİ	1K0121367F
	VW13001 DİREKSİYON KÖRÜĞÜ	Ağırlık : 0.065 kg / 0.143 lb	4D0419831
	VW13006 DİREKSİYON KÖRÜĞÜ	Ağırlık : 0.145 kg / 0.320 lb	1K0423831A, 5C0423831

* Bu sayfada ve katalogdaki tüm araçların adları, markaları, modelleri, sembolleri, logoları, orjinal numaraları (oe) ve diğer üçüncü parti numaraları sadece referans amaçlı kullanılmaktadır.

SUPERB
II 3T4
2008 - 2015











Resim	Ürün Kodu ve Açıklaması	Detay	OEM
	VW13006K DİREKSİYON KÖRÜĞÜ SOL VE SAĞ 2 PİECES	Ağırlık : 0.29 kg / 0.639 lb	1K0423831A, 5C0423831
	VW14003 AKS KÖRÜĞÜ +KELEPÇE+YAĞ. DIŞ	Ağırlık : 0.25 kg / 0.551 lb	1K0 498 203, 1K0498203
	VW14011 AKS KÖRÜĞÜ +KELEPÇE+YAĞ. İÇ	Ağırlık : 0.236 kg / 0.520 lb	1K0498201D
	AU15001 AMORTİSÖR KÖRÜĞÜ ÖN	Şasi (Ön / Arka) : ÖN Ağırlık : 0,110 kg / 0.243 lb	6N0413175A

SUPERB
II ESTATE 3T5
2008 - 2015

Resim	Ürün Kodu ve Açıklaması	Detay	OEM
	VW1014 ROTİL ÖN ALT SAĞ Ø15,6 RB2536	Ağırlık : 0,565 kg / 1.246 lb Konik Ölçüsü : Ø15,6 Bağlantı Delik Çapı : Ø10,5 Aşık Diş Çapı : M12X1,5	1K0407366B, 1K0407366C 1K0407366E, 5Q0407366A
	VW1015 ROTİL ÖN ALT SOL Ø15,6 RB2537	Ağırlık : 0,565 kg / 1.246 lb Konik Ölçüsü : Ø15,6 Bağlantı Delik Çapı : Ø10,5 Aşık Diş Çapı : M12X1,5	1K0407365B, 1K0407365C 1K0407365E, 5Q0407365A
	VW2008 ROTBAŞI ÖN SAĞ RD0342	Ağırlık : 0,412 kg / 0.908 lb Uzunluk : 95 mm / 3.74 inch Gövde Diş Çapı : M16X1,5 Aşık Diş Çapı : M12X1,5 Aşık Konik Çapı : Ø12,7	1K0423812A, 1K0423812C 1K0423812E, 1K0423812G 1K0423812J, 1K0423812K 1KD423812A
	VW2009 ROTBAŞI ÖN SOL RD0343	Ağırlık : 0,412 kg / 0.908 lb Uzunluk : 95 mm / 3.74 inch Gövde Diş Çapı : M16X1,5 Aşık Diş Çapı : M12X1,5 Aşık Konik Çapı : Ø13,5	1K0423811A, 1K0423811C 1K0423811E, 1K0423811G 1K0423811J, 1K0423811K 1KD423811A
	VW3009 ROTMİLİ SAĞ-SOL 310 RB2838	Ağırlık : 0,665 kg / 1.466 lb Uzunluk : 311 mm / 12.24 inch Gövde Diş Çapı : M16X1,5 Aşık Diş Çapı : M16X1,5	1K0423810A
	VW20083009 ROT TAKIMI ÖN AKS SAĞ RB288137	Ağırlık : 1,078 kg / 2.377 lb Rotbaşı : VW2008 Rotmili : VW3009	











* Bu sayfada ve katalogdaki tüm araçların adları, markaları, modelleri, sembolleri, logoları, orjinal numaraları (oe) ve diğer üçüncü parti numaraları sadece referans amaçlı kullanılmaktadır.

SUPERB
II ESTATE 3T5
2008 - 2015

Resim	Ürün Kodu ve Açıklaması	Detay	OEM
	VW20093009 ROT TAKIMI ÖN SOL RB288138	Ağırlık : 1,077 kg / 2.374 lb Rotbaşı : VW2009 Rotmili : VW3009	
	SK4005 Z ROT ÖM SAĞ-SOL L=335MM	Ağırlık : 0,322 kg / 0.710 lb Malzeme Türü : Metal Uzunluk : 335 mm / 13.19 inch Aşık Diş Çapı : M12X1,5	5Q0411315B
	VW4014 Z ROT ÖN SAĞ-SOL METAL 335 RB2935	Ağırlık : 0,46 kg / 1.014 lb Malzeme Türü : Metal Uzunluk : 335 mm / 13.19 inch Aşık Diş Çapı : M12X1,5	1K0411315B, 1K0411315D 1K0411315J, 1K0411315K 1K0411315R, 5Q0411315A 5Q0411315B
	VW4015 Z ROT SOL VE SAĞ METAL RB2937	Ağırlık : 0,373 kg / 0.822 lb Malzeme Türü : Metal Uzunluk : 95,5 mm / 3.76 inch Aşık Diş Çapı : M10X1,5	1K0505465C, 1K0505465D 1K0505465H, 1K0505465J 1K0505465K
	VW4015K Z ROT SOL VE SAĞ METAL	Ağırlık : 0,373 kg / 0.822 lb Malzeme Türü : Metal Uzunluk : 95,5 mm / 3.76 inch Aşık Diş Çapı : M10X1,5	1K0505465C, 1K0505465D 1K0505465H, 1K0505465J 1K0505465K
	AU6010 SALINCAK ÜST SOL VE SAĞ RA5155	Ağırlık : 1,298 kg / 2.862 lb Malzeme Türü : Sac Metal	1K0505323H, 1K0505323N
	SE9001 SALINCAK ALT SAĞ RA5150	Ağırlık : 1 kg / 2.205 lb Malzeme Türü : Sac Metal	1K0501530C
	SE9002 SALINCAK ALT SOL RA5151	Ağırlık : 1 kg / 2.205 lb Malzeme Türü : Sac Metal	1K0501529F
	SK6011 SALINCAK ÖN ALT SAĞ RD10230	Ağırlık : 4,264 kg / 9.401 lb Malzeme Türü : Sac Metal	1K0407152B**, 1K0407152BC**
	SK6011J SALINCAK ÖN ALT SAĞ RD10232	Ağırlık : 3,691 kg / 8.137 lb Malzeme Türü : Sac Metal	1K0407152B, 1K0407152BC
	SK6012 SALINCAK ÖN ALT SOL RD10231	Ağırlık : 4,264 kg / 9.401 lb Malzeme Türü : Sac Metal	1K0407151BC**, 1K0407151H**











* Bu sayfada ve katalogdaki tüm araçların adları, markaları, modelleri, sembolleri, logoları, orijinal numaraları (oe) ve diğer üçüncü parti numaraları sadece referans amaçlı kullanılmaktadır.

SUPERB
II ESTATE 3T5
2008 - 2015

Resim	Ürün Kodu ve Açıklaması	Detay	OEM
	SK6012J SALINCAK ÖN ALT SOL RD10233	Ağırlık : 3,691 kg / 8.137 lb Malzeme Türü : Sac Metal	1K0407151BC, 1K0407151H
	VW9002 SALINCAK ÖN TARAF SAĞ	Ağırlık : 1,79 kg / 3.946 lb Malzeme Türü : Sac Metal	1K0505224E, 1K0505224H 1K0505224K
	VW9003 SALINCAK ÖN TARAF SOL	Ağırlık : 1,79 kg / 3.946 lb Malzeme Türü : Sac Metal	1K0505223E, 1K0505223H 1K0505223K
	AU11014 SALINCAK VE DENGE KOLU BURCU ARKA SOL VE SAĞ	Şasi (Ön / Arka) : ARKA Yön : Sol Ve Sağ Ağırlık : 0.192 kg / 0.423 lb	1K0505543A
	AU11088 SALINCAK VE DENGE KOLU BURCU ARKA	Şasi (Ön / Arka) : ARKA Ağırlık : 0,165 kg / 0.364 lb	1K0505541C, 1K0505541D 3C0505541
	VW11037 SALINCAK VE DENGE KOLU BURCU SOL VE SAĞ	Yön : Sol Ve Sağ Ağırlık : 0.11 kg / 0.243 lb	1K0505279A
	VW11042 SALINCAK VE DENGE KOLU BURCU ORTA SOL VE SAĞ	Yön : Orta Sol Ve Sağ Ağırlık : 0,182 kg / 0.401 lb	1K0407182, 5Q0407182
	VW11043 SALINCAK VE DENGE KOLU BURCU SAĞ B22141	Yön : Sağ Diğer Taraf : VW11044 Ağırlık : 0,659 kg / 1.453 lb	1K0199232G, 1K0199232H 1K0199232J
	VW11043B SALINCAK VE DENGE KOLU BURCU SAĞ	Yön : Sağ Diğer Taraf : VW11044B Ağırlık : 0,659 kg / 1.453 lb Not : İÇ BURÇSUZ	1K0199232G, 1K0199232H 1K0199232J
	VW11044 SALINCAK VE DENGE KOLU BURCU SOL B22142	Yön : Sol Diğer Taraf : VW11043 Ağırlık : 0,678 kg / 1.495 lb	1K0199231G, 1K0199231H 1K0199231J
	VW11044B SALINCAK VE DENGE KOLU BURCU SOL	Yön : Sol Diğer Taraf : VW11043B Ağırlık : 0,678 kg / 1.495 lb Not : İÇ BURÇSUZ	1K0199231G, 1K0199231H 1K0199231J

* Bu sayfada ve katalogdaki tüm araçların adları, markaları, modelleri, sembolleri, logoları, orjinal numaraları (oe) ve diğer üçüncü parti numaraları sadece referans amaçlı kullanılmaktadır.

SUPERB
II ESTATE 3T5
2008 - 2015

Resim	Ürün Kodu ve Açıklaması	Detay	OEM
	VW11051 SALINCAK VE DENGİ KOLU BURCU SOL VE SAĞ	Yön : Sol Ve Sağ Ağırlık : 0.121 kg / 0.267 lb	6Q0407183, 6Q0407183A
	VW11056 SALINCAK VE DENGİ KOLU BURCU ARKA SOL VE SAĞ	Şasi (Ön / Arka) : ARKA Yön : Sol Ve Sağ Ağırlık : 0.13 kg / 0.287 lb	1K0505203A, 1K0505323D 1K0505323G, 1K0505323H 1K0505323N, 5Q0505323C
	VW11180 Z-ROT BURCU ARKA	Şasi (Ön / Arka) : ARKA Ağırlık : 0.069 kg / 0.152 lb Uzunluk : VW4015 mm / 0.00 inch Aşık Diş Çapı : VW4015K	1K0505465C*, 1K0505465D* 1K0505465H*, 1K0505465J* 1K0505465K*
	VW12159 TAŞIYICI DESTEK BURÇLARI ARKA SOL VE SAĞ	Şasi (Ön / Arka) : ARKA Yön : Sol Ve Sağ Ağırlık : 0,130 kg / 0.287 lb	1K0505553, 1K0505553A
	AU12024 TORSİYON BURCU ARKA SOL VE SAĞ	Şasi (Ön / Arka) : ARKA Yön : Sol Ve Sağ Ağırlık : 0.557 kg / 1.228 lb	1K0505145F, 1K0505145H 1K0505145K
	SK12003 VİRAJ DEMİR LASTİĞİ SOL VE SAĞ RUBBER	Şasi (Ön / Arka) : ÖN Yön : Sol Ve Sağ Ağırlık : 0,075 kg / 0.165 lb Malzeme Türü : Rubber	1K0411303, 1K0411303AL* 1K0411303BK, 1K0411314 3C0411303AA*, 3C0411303T*
	SK12003K VİRAJ DEMİR LASTİĞİ SOL VE SAĞ RUBBER	Şasi (Ön / Arka) : ÖN Yön : Sol Ve Sağ Ağırlık : 0,150 kg / 0.331 lb Malzeme Türü : Rubber	1K0411303, 1K0411303AL* 1K0411303BK, 1K0411314 3C0411303AA*, 3C0411303T*
	VW12137 VİRAJ DEMİR LASTİĞİ	Şasi (Ön / Arka) : ARKA Ağırlık : 0,070 kg / 0.154 lb Not : Ø17mm	1K0511327AQ
	VW12137K VİRAJ DEMİR LASTİĞİ	Şasi (Ön / Arka) : ARKA Ağırlık : 0,140 kg / 0.309 lb Not : KIT	1K0511327AQ
	VW12017 AMORTİSÖR TAKOĞU SOL VE SAĞ AMORTİSÖR TAKOĞU	Yön : Sol Ve Sağ Ağırlık : 0.847 kg / 1.867 lb Not : AMORTİSÖR TAKOĞU	1K0412331B, 1K0412331C
	VW12109 AMORTİSÖR TAKOĞU SOL VE SAĞ AMORTİSÖR RULMANI	Yön : Sol Ve Sağ Ağırlık : 0.26 kg / 0.573 lb Not : AMORTİSÖR RULMANI	6N0412249C, 6N0412249E











* Bu sayfada ve katalogdaki tüm araçların adları, markaları, modelleri, sembolleri, logoları, orijinal numaraları (oe) ve diğer üçüncü parti numaraları sadece referans amaçlı kullanılmaktadır.

SUPERB
II ESTATE 3T5
2008 - 2015

Resim	Ürün Kodu ve Açıklaması	Detay	OEM
	VW12109K AMORTİSÖR TAKOZU SOL VE SAĞ 2 PCS	Yön : Sol Ve Sağ Ağırlık : 0.52 kg / 1.146 lb Not : 2 PCS	6N0412249C, 6N0412249E
	VW12106 ŞANZİMAN TAKOZU SOL ŞANZİMAN TAKOZU SOL	Yön : Sol Ağırlık : 1.95 kg / 4.299 lb Not : ŞANZİMAN TAKOZU SOL	1K0199555AT, 1K0199555T
	VW12038 SÜSPANSİYON TAKOZU SOL VE SAĞ SUS. ARA YATAK TAKOZ ARKA	Yön : Sol Ve Sağ Ağırlık : 0.12 kg / 0.265 lb Not : SUS. ARA YATAK TAKOZ ARKA	3C0 511 359, 3C0511359
	VW12051 SÜSPANSİYON TAKOZU SOL VE SAĞ LASTİK DAYANAK SÜSPANSİYON	Yön : Sol Ve Sağ Ağırlık : 0.045 kg / 0.099 lb Not : LASTİK DAYANAK SÜSPANSİYON	1K0412303B
	VW12086 RADYATÖR TAKOZU SOL VE SAĞ RADYATÖR ÜST LASTİĞİ	Yön : Sol Ve Sağ Ağırlık : 0.024 kg / 0.053 lb Not : RADYATÖR ÜST LASTİĞİ	1K0121367F
	VW13001 DİREKSİYON KÖRÜĞÜ	Ağırlık : 0.065 kg / 0.143 lb	4D0419831
	VW13006 DİREKSİYON KÖRÜĞÜ	Ağırlık : 0.145 kg / 0.320 lb	1K0423831A, 5C0423831
	VW13006K DİREKSİYON KÖRÜĞÜ SOL VE SAĞ 2 PİECES	Ağırlık : 0.29 kg / 0.639 lb	1K0423831A, 5C0423831
	VW14003 AKS KÖRÜĞÜ +KELEPÇE+YAĞ. DIŞ	Ağırlık : 0.25 kg / 0.551 lb	1K0 498 203, 1K0498203
	VW14011 AKS KÖRÜĞÜ +KELEPÇE+YAĞ. İÇ	Ağırlık : 0.236 kg / 0.520 lb	1K0498201D
	AU15001 AMORTİSÖR KÖRÜĞÜ ÖN	Şasi (Ön / Arka) : ÖN Ağırlık : 0,110 kg / 0.243 lb	6N0413175A











* Bu sayfada ve katalogdaki tüm araçların adları, markaları, modelleri, sembolleri, logoları, orjinal numaraları (oe) ve diğer üçüncü parti numaraları sadece referans amaçlı kullanılmaktadır.

SUPERB
III 3V3
2015 - 2024

Resim	Ürün Kodu ve Açıklaması	Detay	OEM
	VW1019 ROTİL ÖN SAĞ Ø15,3 RB2538	Ağırlık : 0,555 kg / 1.224 lb Konik Ölçüsü : Ø15,3 Bağlantı Delik Çapı : Ø10,5 Aşık Diş Çapı : M12X1,5	3C0407366A
	VW1020 ROTİL ÖN SOL Ø15,3 RB2539	Ağırlık : 0,555 kg / 1.224 lb Konik Ölçüsü : Ø15,3 Bağlantı Delik Çapı : Ø10,5 Aşık Diş Çapı : M12X1,5	3C0407365A
	VW3021 ROTMİLİ SAĞ-SOL	Ağırlık : 0,705 kg / 1.554 lb Uzunluk : 330 mm / 12.99 inch	561423810
	VW20083021 ROT TAKIMI ÖN AKS SAĞ	Ağırlık : 1,2 kg / 2.646 lb Rotbaşı : VW2008 Rotmili : VW3021	561423810, 561423810S1
	VW20093021 ROT TAKIMI ÖN SOL	Ağırlık : 1,2 kg / 2.646 lb Rotbaşı : VW2009 Rotmili : VW3021	561423810 S2, 561423810
	SK4005 Z ROT ÖM SAĞ-SOL L=335MM	Ağırlık : 0,322 kg / 0.710 lb Malzeme Türü : Metal Uzunluk : 335 mm / 13.19 inch Aşık Diş Çapı : M12X1,5	5Q0411315B
	AU9012 SALINCAK ARKA ALT SAĞ	Ağırlık : 1,640 kg / 3.616 lb Malzeme Türü : Sac Metal	5Q0505224D
	AU9013 SALINCAK ARKA ALT SOL	Ağırlık : 1,640 kg / 3.616 lb Malzeme Türü : Sac Metal	5Q0505223D
	SK9002 SALINCAK ALT SOL VE SAĞ	Ağırlık : 2,914 kg / 6.424 lb Malzeme Türü : Sac Metal	3Q0505311C, 3Q0505311D 3Q0505311E
	VW6055 SALINCAK ÖN ALT SAĞ	Ağırlık : 3,768 kg / 8.307 lb Malzeme Türü : Sac Metal	3Q0407152E*, 3Q0407152E 3Q0407152F*, 3Q0407152F 3Q0407154B*, 3Q0407154B
	VW6055J SALINCAK ÖN ALT SAĞ	Malzeme Türü : Sac Metal	3Q0407152E, 3Q0407152F 3Q0407154B







* Bu sayfada ve katalogdaki tüm araçların adları, markaları, modelleri, sembolleri, logoları, orjinal numaraları (oe) ve diğer üçüncü parti numaraları sadece referans amaçlı kullanılmaktadır.

SUPERB
III 3V3
2015 - 2024



Resim	Ürün Kodu ve Açıklaması	Detay	OEM
	VW6056 SALINCAK ÖN ALT SOL	Ağırlık : 3,768 kg / 8.307 lb Malzeme Türü : Sac Metal	3Q0407151E*, 3Q0407151E 3Q0407151F*, 3Q0407151F 3Q0407153B*, 3Q0407153B
	VW6056J SALINCAK ÖN ALT SOL	Malzeme Türü : Sac Metal	3Q0407151E, 3Q0407151F 3Q0407153B
	VW9006 SALINCAK ALT SAĞ	Ağırlık : 1,992 kg / 4.392 lb Malzeme Türü : Sac Metal	3Q0505224
	VW9007 SALINCAK ALT SOL	Ağırlık : 1,992 kg / 4.392 lb Malzeme Türü : Sac Metal	3Q0505223
	AU11068 SALINCAK VE DENG KOLU BURCU ARKA ALT SOL VE SAĞ METAL	Şasi (Ön / Arka) : ARKA Yön : Alt Sol Ve Sağ Ağırlık : 0,201 kg / 0.443 lb Malzeme Türü : Metal	PART OF 5Q0505223D, PART OF 5Q0505224D
	SK11006 SALINCAK VE DENG KOLU BURCU ARKA ALT	Şasi (Ön / Arka) : ARKA Yön : Alt Ağırlık : 0,125 kg / 0.276 lb	3Q0505311C*, 3Q0505311D* 3Q0505311E*, 5Q0505171B*
	VW11037 SALINCAK VE DENG KOLU BURCU SOL VE SAĞ	Yön : Sol Ve Sağ Ağırlık : 0.11 kg / 0.243 lb	1K0505279A
	VW11042 SALINCAK VE DENG KOLU BURCU ORTA SOL VE SAĞ	Yön : Orta Sol Ve Sağ Ağırlık : 0,182 kg / 0.401 lb	1K0407182, 5Q0407182
	VW11063 SALINCAK VE DENG KOLU BURCU SOL VE SAĞ	Yön : Sol Ve Sağ Ağırlık : 0.34 kg / 0.750 lb	5Q0407183D, 5Q0407183E
	AU11080 BEŞİK (TRAVERS) BURCU ÖN ALT	Şasi (Ön / Arka) : ÖN Yön : Alt Ağırlık : 0,135 kg / 0.298 lb	5Q0505553
	AU12022 MOTOR TAKOZU SOL VE SAĞ MOTOR TAKOZU	Yön : Sol Ve Sağ Ağırlık : 1.58 kg / 3.483 lb Malzeme Türü : Motor Takozu	5Q0199262, 5Q0199262BH 5Q0199262DE

* Bu sayfada ve katalogdaki tüm araçların adları, markaları, modelleri, sembolleri, logoları, orjinal numaraları (oe) ve diğer üçüncü parti numaraları sadece referans amaçlı kullanılmaktadır.

SUPERB
III 3V3
2015 - 2024

Resim	Ürün Kodu ve Açıklaması	Detay	OEM
	AU12023 MOTOR TAKOZU SOL VE SAĞ MOTOR TAKOZU 7 İLERİ	Yön : Sol Ve Sağ Ağırlık : 1.58 kg / 3.483 lb Malzeme Türü : Motor Takozu Not : 7 İLERİ	5Q0199262BE, 5Q0199262BF
	AU12026 MOTOR TAKOZU ÖN SOL VE SAĞ	Şasi (Ön / Arka) : ÖN Yön : Sol Ve Sağ Ağırlık : 0,850 kg / 1.874 lb	5Q0199855AD, 5Q0199855J 5Q0199855P, 5Q0199855Q
	VW12157 MOTOR TAKOZU ÖN SOL VE SAĞ	Şasi (Ön / Arka) : ÖN Yön : Sol Ve Sağ Ağırlık : 2.2 kg / 4.850 lb	5Q0199555AF, 5Q0199555T 5Q01999555AP
	VW12051 SÜSPANSİYON TAKOZU SOL VE SAĞ LASTİK DAYANAK SÜSPANSİYON	Yön : Sol Ve Sağ Ağırlık : 0.045 kg / 0.099 lb Not : LASTİK DAYANAK SÜSPANSİYON	1K0412303B
	VW12086 RADYATÖR TAKOZU SOL VE SAĞ RADYATÖR ÜST LASTİĞİ	Yön : Sol Ve Sağ Ağırlık : 0.024 kg / 0.053 lb Not : RADYATÖR ÜST LASTİĞİ	1K0121367F
	VW13006 DİREKSİYON KÖRÜĞÜ	Ağırlık : 0.145 kg / 0.320 lb	1K0423831A, 5C0423831
	VW13006K DİREKSİYON KÖRÜĞÜ SOL VE SAĞ 2 PİECES	Ağırlık : 0.29 kg / 0.639 lb	1K0423831A, 5C0423831

SUPERB
III ESTATE 3V5
2015 - 2024

Resim	Ürün Kodu ve Açıklaması	Detay	OEM
	VW1019 ROTİL ÖN SAĞ Ø15,3 RB2538	Ağırlık : 0,555 kg / 1.224 lb Konik Ölçüsü : Ø15,3 Bağlantı Delik Çapı : Ø10,5 Aşık Diş Çapı : M12X1,5	3C0407366A
	VW1020 ROTİL ÖN SOL Ø15,3 RB2539	Ağırlık : 0,555 kg / 1.224 lb Konik Ölçüsü : Ø15,3 Bağlantı Delik Çapı : Ø10,5 Aşık Diş Çapı : M12X1,5	3C0407365A
	VW3021 ROTMİLİ SAĞ-SOL	Ağırlık : 0,705 kg / 1.554 lb Uzunluk : 330 mm / 12.99 inch	561423810











* Bu sayfada ve katalogdaki tüm araçların adları, markaları, modelleri, sembolleri, logoları, orjinal numaraları (oe) ve diğer üçüncü parti numaraları sadece referans amaçlı kullanılmaktadır.

SUPERB
III ESTATE 3V5
2015 - 2024

Resim	Ürün Kodu ve Açıklaması	Detay	OEM
	VW20083021 ROT TAKIMI ÖN AKS SAĞ	Ağırlık : 1,2 kg / 2.646 lb Rotbaşı : VW2008 Rotmili : VW3021	561423810, 561423810S1
	VW20093021 ROT TAKIMI ÖN SOL	Ağırlık : 1,2 kg / 2.646 lb Rotbaşı : VW2009 Rotmili : VW3021	561423810 S2, 561423810
	SK4005 Z ROT ÖM SAĞ-SOL L=335MM	Ağırlık : 0,322 kg / 0.710 lb Malzeme Türü : Metal Uzunluk : 335 mm / 13.19 inch Aşık Diş Çapı : M12X1,5	5Q0411315B
	AU9012 SALINCAK ARKA ALT SAĞ	Ağırlık : 1,640 kg / 3.616 lb Malzeme Türü : Sac Metal	5Q0505224D
	AU9013 SALINCAK ARKA ALT SOL	Ağırlık : 1,640 kg / 3.616 lb Malzeme Türü : Sac Metal	5Q0505223D
	SK9002 SALINCAK ALT SOL VE SAĞ	Ağırlık : 2,914 kg / 6.424 lb Malzeme Türü : Sac Metal	3Q0505311C, 3Q0505311D 3Q0505311E
	VW6055 SALINCAK ÖN ALT SAĞ	Ağırlık : 3,768 kg / 8.307 lb Malzeme Türü : Sac Metal	3Q0407152E*, 3Q0407152E 3Q0407152F*, 3Q0407152F 3Q0407154B*, 3Q0407154B
	VW6055J SALINCAK ÖN ALT SAĞ	Malzeme Türü : Sac Metal	3Q0407152E, 3Q0407152F 3Q0407154B
	VW6056 SALINCAK ÖN ALT SOL	Ağırlık : 3,768 kg / 8.307 lb Malzeme Türü : Sac Metal	3Q0407151E*, 3Q0407151E 3Q0407151F*, 3Q0407151F 3Q0407153B*, 3Q0407153B
	VW6056J SALINCAK ÖN ALT SOL	Malzeme Türü : Sac Metal	3Q0407151E, 3Q0407151F 3Q0407153B
	VW9006 SALINCAK ALT SAĞ	Ağırlık : 1,992 kg / 4.392 lb Malzeme Türü : Sac Metal	3Q0505224





* Bu sayfada ve katalogdaki tüm araçların adları, markaları, modelleri, sembolleri, logoları, orjinal numaraları (oe) ve diğer üçüncü parti numaraları sadece referans amaçlı kullanılmaktadır.

SUPERB
III ESTATE 3V5
2015 - 2024

Resim	Ürün Kodu ve Açıklaması	Detay	OEM
	VW9007 SALINCAK ALT SOL	Ağırlık : 1,992 kg / 4.392 lb Malzeme Türü : Sac Metal	3Q0505223
	AU11068 SALINCAK VE DENG KOLU BURCU ARKA ALT SOL VE SAĞ METAL	Şasi (Ön / Arka) : ARKA Yön : Alt Sol Ve Sağ Ağırlık : 0,201 kg / 0.443 lb Malzeme Türü : Metal	PART OF 5Q0505223D, PART OF 5Q0505224D
	SK11006 SALINCAK VE DENG KOLU BURCU ARKA ALT	Şasi (Ön / Arka) : ARKA Yön : Alt Ağırlık : 0,125 kg / 0.276 lb	3Q0505311C*, 3Q0505311D* 3Q0505311E*, 5Q0505171B*
	VW11037 SALINCAK VE DENG KOLU BURCU SOL VE SAĞ	Yön : Sol Ve Sağ Ağırlık : 0.11 kg / 0.243 lb	1K0505279A
	VW11042 SALINCAK VE DENG KOLU BURCU ORTA SOL VE SAĞ	Yön : Orta Sol Ve Sağ Ağırlık : 0,182 kg / 0.401 lb	1K0407182, 5Q0407182
	VW11063 SALINCAK VE DENG KOLU BURCU SOL VE SAĞ	Yön : Sol Ve Sağ Ağırlık : 0.34 kg / 0.750 lb	5Q0407183D, 5Q0407183E
	AU11080 BEŞİK (TRAVERS) BURCU ÖN ALT	Şasi (Ön / Arka) : ÖN Yön : Alt Ağırlık : 0,135 kg / 0.298 lb	5Q0505553
	AU12022 MOTOR TAKOZU SOL VE SAĞ MOTOR TAKOZU	Yön : Sol Ve Sağ Ağırlık : 1.58 kg / 3.483 lb Malzeme Türü : Motor Takozu	5Q0199262, 5Q0199262BH 5Q0199262DE
	AU12023 MOTOR TAKOZU SOL VE SAĞ MOTOR TAKOZU 7 İLERİ	Yön : Sol Ve Sağ Ağırlık : 1.58 kg / 3.483 lb Malzeme Türü : Motor Takozu Not : 7 İLERİ	5Q0199262BE, 5Q0199262BF
	AU12026 MOTOR TAKOZU ÖN SOL VE SAĞ	Şasi (Ön / Arka) : ÖN Yön : Sol Ve Sağ Ağırlık : 0,850 kg / 1.874 lb	5Q0199855AD, 5Q0199855J 5Q0199855P, 5Q0199855Q
	VW12157 MOTOR TAKOZU ÖN SOL VE SAĞ	Şasi (Ön / Arka) : ÖN Yön : Sol Ve Sağ Ağırlık : 2.2 kg / 4.850 lb	5Q0199555AF, 5Q0199555T 5Q0199555AP

* Bu sayfada ve katalogdaki tüm araçların adları, markaları, modelleri, sembolleri, logoları, orijinal numaraları (oe) ve diğer üçüncü parti numaraları sadece referans amaçlı kullanılmaktadır.

SUPERB
III ESTATE 3V5
2015 - 2024

Resim	Ürün Kodu ve Açıklaması	Detay	OEM
	VW12051 SÜSPANSİYON TAKOZU SOL VE SAĞ LASTİK DAYANAK SUSPENSİYON	Yön : Sol Ve Sağ Ağırlık : 0.045 kg / 0.099 lb Not : LASTİK DAYANAK SUSPENSİYON	1K0412303B
	VW12086 RADYATÖR TAKOZU SOL VE SAĞ RADYATÖR ÜST LASTİĞİ	Yön : Sol Ve Sağ Ağırlık : 0.024 kg / 0.053 lb Not : RADYATÖR ÜST LASTİĞİ	1K0121367F
	VW13006 DİREKSİYON KÖRÜĞÜ	Ağırlık : 0.145 kg / 0.320 lb	1K0423831A, 5C0423831
	VW13006K DİREKSİYON KÖRÜĞÜ SOL VE SAĞ 2 PİECES	Ağırlık : 0.29 kg / 0.639 lb	1K0423831A, 5C0423831

YETİ
5L
2009 - 2017

Resim	Ürün Kodu ve Açıklaması	Detay	OEM
	VW1014 ROTİL ÖN ALT SAĞ Ø15,6 RB2536	Ağırlık : 0,565 kg / 1.246 lb Konik Ölçüsü : Ø15,6 Bağlantı Delik Çapı : Ø10,5 Aşık Dış Çapı : M12X1,5	1K0407366B, 1K0407366C 1K0407366E, 5Q0407366A
	VW1015 ROTİL ÖN ALT SOL Ø15,6 RB2537	Ağırlık : 0,565 kg / 1.246 lb Konik Ölçüsü : Ø15,6 Bağlantı Delik Çapı : Ø10,5 Aşık Dış Çapı : M12X1,5	1K0407365B, 1K0407365C 1K0407365E, 5Q0407365A
	VW2008 ROTBAŞI ÖN SAĞ RD0342	Ağırlık : 0,412 kg / 0.908 lb Uzunluk : 95 mm / 3.74 inch Gövde Dış Çapı : M16X1,5 Aşık Dış Çapı : M12X1,5 Aşık Konik Çapı : Ø12,7	1K0423812A, 1K0423812C 1K0423812E, 1K0423812G 1K0423812J, 1K0423812K 1KD423812A
	VW2009 ROTBAŞI ÖN SOL RD0343	Ağırlık : 0,412 kg / 0.908 lb Uzunluk : 95 mm / 3.74 inch Gövde Dış Çapı : M16X1,5 Aşık Dış Çapı : M12X1,5 Aşık Konik Çapı : Ø13,5	1K0423811A, 1K0423811C 1K0423811E, 1K0423811G 1K0423811J, 1K0423811K 1KD423811A
	VW3009 ROTMİLİ SAĞ-SOL 310 RB2838	Ağırlık : 0,665 kg / 1.466 lb Uzunluk : 311 mm / 12.24 inch Gövde Dış Çapı : M16X1,5 Aşık Dış Çapı : M16X1,5	1K0423810A
	VW20083009 ROT TAKIMI ÖN AKS SAĞ RB288137	Ağırlık : 1,078 kg / 2.377 lb Rotbaşı : VW2008 Rotmilî : VW3009	

* Bu sayfada ve katalogdaki tüm araçların adları, markaları, modelleri, sembolleri, logoları, orjinal numaraları (oe) ve diğer üçüncü parti numaraları sadece referans amaçlı kullanılmaktadır.

YETI 5L 2009 - 2017

Resim	Ürün Kodu ve Açıklaması	Detay	OEM
	VW20093009 ROT TAKIMI ÖN SOL RB288138	Ağırlık : 1,077 kg / 2.374 lb Rotbaşı : VW2009 Rotmili : VW3009	
	SK4005 Z ROT ÖM SAĞ-SOL L=335MM	Ağırlık : 0,322 kg / 0.710 lb Malzeme Türü : Metal Uzunluk : 335 mm / 13.19 inch Aşık Diş Çapı : M12X1,5	5Q0411315B
	VW4014 Z ROT ÖN SAĞ-SOL METAL 335 RB2935	Ağırlık : 0,46 kg / 1.014 lb Malzeme Türü : Metal Uzunluk : 335 mm / 13.19 inch Aşık Diş Çapı : M12X1,5	1K0411315B, 1K0411315D 1K0411315J, 1K0411315K 1K0411315R, 5Q0411315A 5Q0411315B
	VW4015 Z ROT SOL VE SAĞ METAL RB2937	Ağırlık : 0,373 kg / 0.822 lb Malzeme Türü : Metal Uzunluk : 95,5 mm / 3.76 inch Aşık Diş Çapı : M10X1,5	1K0505465C, 1K0505465D 1K0505465H, 1K0505465J 1K0505465K
	VW4015K Z ROT SOL VE SAĞ METAL	Ağırlık : 0,373 kg / 0.822 lb Malzeme Türü : Metal Uzunluk : 95,5 mm / 3.76 inch Aşık Diş Çapı : M10X1,5	1K0505465C, 1K0505465D 1K0505465H, 1K0505465J 1K0505465K
	SK6011 SALINCAK ÖN ALT SAĞ RD10230	Ağırlık : 4,264 kg / 9.401 lb Malzeme Türü : Sac Metal	1K0407152B**, 1K0407152BC**
	SK6011J SALINCAK ÖN ALT SAĞ RD10232	Ağırlık : 3,691 kg / 8.137 lb Malzeme Türü : Sac Metal	1K0407152B, 1K0407152BC
	SK6012 SALINCAK ÖN ALT SOL RD10231	Ağırlık : 4,264 kg / 9.401 lb Malzeme Türü : Sac Metal	1K0407151BC**, 1K0407151H**
	SK6012J SALINCAK ÖN ALT SOL RD10233	Ağırlık : 3,691 kg / 8.137 lb Malzeme Türü : Sac Metal	1K0407151BC, 1K0407151H
	SK9001 SALINCAK ARKA ALT	Ağırlık : 0,701 kg / 1.545 lb Malzeme Türü : Sac Metal	1K0501529J
	AU11014 SALINCAK VE DENGE KOLU BURCU ARKA SOL VE SAĞ	Şasi (Ön / Arka) : ARKA Yön : Sol Ve Sağ Ağırlık : 0.192 kg / 0.423 lb	1K0505543A







* Bu sayfada ve katalogdaki tüm araçların adları, markaları, modelleri, sembolleri, logoları, orjinal numaraları (oe) ve diğer üçüncü parti numaraları sadece referans amaçlı kullanılmaktadır.

YETI 5L 2009 - 2017

Resim	Ürün Kodu ve Açıklaması	Detay	OEM
	AU11035 SALINCAK VE DENGE KOLU BURCU ARKA SOL VE SAĞ	Şasi (Ön / Arka) : ARKA Yön : Sol Ve Sağ Ağırlık : 0,25 kg / 0.551 lb	1K0505171C
	SK11009 SALINCAK VE DENGE KOLU BURCU ARKA SOL VE SAĞ	Şasi (Ön / Arka) : ARKA Yön : Sol Ve Sağ Ağırlık : 0,176 kg / 0.388 lb	1K0501529J*
	SK11010 SALINCAK VE DENGE KOLU BURCU ARKA SOL VE SAĞ	Şasi (Ön / Arka) : ARKA Yön : Sol Ve Sağ Ağırlık : 0,196 kg / 0.432 lb Not : BÜYÜK	1K0501529J*
	VW11037 SALINCAK VE DENGE KOLU BURCU SOL VE SAĞ	Yön : Sol Ve Sağ Ağırlık : 0.11 kg / 0.243 lb	1K0505279A
	VW11042 SALINCAK VE DENGE KOLU BURCU ORTA SOL VE SAĞ	Yön : Orta Sol Ve Sağ Ağırlık : 0,182 kg / 0.401 lb	1K0407182, 5Q0407182
	VW11043 SALINCAK VE DENGE KOLU BURCU SAĞ B22141	Yön : Sağ Diğer Taraf : VW11044 Ağırlık : 0,659 kg / 1.453 lb	1K0199232G, 1K0199232H 1K0199232J
	VW11043B SALINCAK VE DENGE KOLU BURCU SAĞ	Yön : Sağ Diğer Taraf : VW11044B Ağırlık : 0,659 kg / 1.453 lb Not : İÇ BURÇSUZ	1K0199232G, 1K0199232H 1K0199232J
	VW11044 SALINCAK VE DENGE KOLU BURCU SOL B22142	Yön : Sol Diğer Taraf : VW11043 Ağırlık : 0,678 kg / 1.495 lb	1K0199231G, 1K0199231H 1K0199231J
	VW11044B SALINCAK VE DENGE KOLU BURCU SOL	Yön : Sol Diğer Taraf : VW11043B Ağırlık : 0,678 kg / 1.495 lb Not : İÇ BURÇSUZ	1K0199231G, 1K0199231H 1K0199231J
	VW11051 SALINCAK VE DENGE KOLU BURCU SOL VE SAĞ	Yön : Sol Ve Sağ Ağırlık : 0.121 kg / 0.267 lb	6Q0407183, 6Q0407183A
	VW11180 Z-ROT BURCU ARKA	Şasi (Ön / Arka) : ARKA Ağırlık : 0.069 kg / 0.152 lb Uzunluk : VW4015 mm / 0.00 inch Aşık Dış Çapı : VW4015K	1K0505465C*, 1K0505465D* 1K0505465H*, 1K0505465J* 1K0505465K*



* Bu sayfada ve katalogdaki tüm araçların adları, markaları, modelleri, sembolleri, logoları, orjinal numaraları (oe) ve diğer üçüncü parti numaraları sadece referans amaçlı kullanılmaktadır.

YETI 5L 2009 - 2017

Resim	Ürün Kodu ve Açıklaması	Detay	OEM
	VW12159 TAŞIYICI DESTEK BURÇLARI ARKA SOL VE SAĞ	Şasi (Ön / Arka) : ARKA Yön : Sol Ve Sağ Ağırlık : 0,130 kg / 0.287 lb	1K0505553, 1K0505553A
	AU12024 TORSİYON BURCU ARKA SOL VE SAĞ	Şasi (Ön / Arka) : ARKA Yön : Sol Ve Sağ Ağırlık : 0.557 kg / 1.228 lb	1K0505145F, 1K0505145H 1K0505145K
	SK12003 VİRAJ DEMİR LASTİĞİ SOL VE SAĞ RUBBER	Şasi (Ön / Arka) : ÖN Yön : Sol Ve Sağ Ağırlık : 0,075 kg / 0.165 lb Malzeme Türü : Rubber	1K0411303, 1K0411303AL* 1K0411303BK, 1K0411314 3C0411303AA*, 3C0411303T*
	SK12003K VİRAJ DEMİR LASTİĞİ SOL VE SAĞ RUBBER	Şasi (Ön / Arka) : ÖN Yön : Sol Ve Sağ Ağırlık : 0,150 kg / 0.331 lb Malzeme Türü : Rubber	1K0411303, 1K0411303AL* 1K0411303BK, 1K0411314 3C0411303AA*, 3C0411303T*
	VW12137 VİRAJ DEMİR LASTİĞİ	Şasi (Ön / Arka) : ARKA Ağırlık : 0,070 kg / 0.154 lb Not : Ø17mm	1K0511327AQ
	VW12137K VİRAJ DEMİR LASTİĞİ	Şasi (Ön / Arka) : ARKA Ağırlık : 0,140 kg / 0.309 lb Not : KIT	1K0511327AQ
	VW12017 AMORTİSÖR TAKOZU SOL VE SAĞ AMORTİSÖR TAKOZU	Yön : Sol Ve Sağ Ağırlık : 0.847 kg / 1.867 lb Not : AMORTİSÖR TAKOZU	1K0412331B, 1K0412331C
	VW12109 AMORTİSÖR TAKOZU SOL VE SAĞ AMORTİSÖR RULMANI	Yön : Sol Ve Sağ Ağırlık : 0.26 kg / 0.573 lb Not : AMORTİSÖR RULMANI	6N0412249C, 6N0412249E
	VW12109K AMORTİSÖR TAKOZU SOL VE SAĞ 2 PCS	Yön : Sol Ve Sağ Ağırlık : 0.52 kg / 1.146 lb Not : 2 PCS	6N0412249C, 6N0412249E
	VW12027 MOTOR TAKOZU SOL VE SAĞ MOTOR KULAĞI	Yön : Sol Ve Sağ Ağırlık : 2.02 kg / 4.453 lb Not : MOTOR KULAĞI	1K0199262, 1K0199262CN
	VW12077 MOTOR TAKOZU SOL VE SAĞ MOTOR TAKOZU	Yön : Sol Ve Sağ Ağırlık : 1.95 kg / 4.299 lb Not : MOTOR TAKOZU	1K0199262CG, 1K0199262CP

* Bu sayfada ve katalogdaki tüm araçların adları, markaları, modelleri, sembolleri, logoları, orjinal numaraları (oe) ve diğer üçüncü parti numaraları sadece referans amaçlı kullanılmaktadır.

YETİ
5L
2009 - 2017

Resim	Ürün Kodu ve Açıklaması	Detay	OEM
	VW12082 MOTOR TAKOZU SOL VE SAĞ MOTOR TAKOZU	Yön : Sol Ve Sağ Ağırlık : 2.05 kg / 4.519 lb Not : MOTOR TAKOZU	1K0199262AK, 1K0199262K
	VW12097 MOTOR TAKOZU SOL VE SAĞ MOTOR TAKOZU	Yön : Sol Ve Sağ Ağırlık : 0.251 kg / 0.553 lb Not : MOTOR TAKOZU	1K0199868, 1K0199868A 1K0199868C, 1K0199868P 1K0199868Q
	VW12038 SÜSPANSİYON TAKOZU SOL VE SAĞ SUS. ARA YATAK TAKOZ ARKA	Yön : Sol Ve Sağ Ağırlık : 0.12 kg / 0.265 lb Not : SUS. ARA YATAK TAKOZ ARKA	3C0 511 359, 3C0511359
	VW12086 RADYATÖR TAKOZU SOL VE SAĞ RADYATÖR ÜST LASTİĞİ	Yön : Sol Ve Sağ Ağırlık : 0.024 kg / 0.053 lb Not : RADYATÖR ÜST LASTİĞİ	1K0121367F
	VW13006 DİREKSİYON KÖRÜĞÜ	Ağırlık : 0.145 kg / 0.320 lb	1K0423831A, 5C0423831
	VW13006K DİREKSİYON KÖRÜĞÜ SOL VE SAĞ 2 PİECES	Ağırlık : 0.29 kg / 0.639 lb	1K0423831A, 5C0423831
	VW14003 AKS KÖRÜĞÜ +KELEPÇE+YAĞ. DIŞ	Ağırlık : 0.25 kg / 0.551 lb	1K0 498 203, 1K0498203
	AU15001 AMORTİSÖR KÖRÜĞÜ ÖN	Şasi (Ön / Arka) : ÖN Ağırlık : 0,110 kg / 0.243 lb	6N0413175A

RIW[®]

NOTLAR

Ürün Kodu	Bilgi Notu
AU1014K ROTİL ÖN SAĞ Ø15 RB2530	WITH CONNECTING METAL
AU1015K ROTİL ÖN SOL Ø15 RB2529	WITH CONNECTING METAL
AU11007 SALINCAK VE DENGE KOLU BURCU ÖN ALT SOL VE SAĞ	HYDROLIC
AU11091 ROTMİLİ BURCU VE LASTİĞİ	SEMI-FINISHED PRODUCT
AU12012 EGZOZ TAKOZU ÖN SOL VE SAĞ EGSOZ LASTİĞİ	FOR EXHAUST SYSTEM
AU12019K MOTOR TAKOZU SOL VE SAĞ MOTOR TAKOZU TAKIM	KIT = AU12019 and AU12020
AU12026 MOTOR TAKOZU ÖN SOL VE SAĞ	AUDI A3 : 1.6 TDI - 2,0 TDI / AUDI TT : 1.8 TFSI - 2,0 TFSI / SEAT LEON: PDT - PFL - PFN / VW GOLF VII AND TOURAN : 1,4 TSI - 1.6 TDI - 2.0 TSI - 2.0 TDI / VW TOURAN : 1.6 TDI - 2.0 TDI / SEAT ATECA : 1,0 TSI - 1,6 TDI - 2,0 TDI /
AU12035 ŞANZIMAN TAKOZU	HYDRAULIC
AU14001 AKS KÖRÜĞÜ +KELEPÇE+YAĞ.	SET = BELOW, CLAMPING CLIP and MOLYBDENUM GREASE
AU20093001 ROT TAKIMI SAĞ	CH. NO: 8L.W-050-423 -->
AU20103001 ROT TAKIMI SOL	CH. NO: 8L.W-050-423 -->
AU2214 ROTBAŞI ÖN SAĞ - SOL RB2214	CH. NO: .-> 8D-W-260192 -> 8D-W-152089
AU2214A ROTBAŞI SAĞ-SOL (KOMPLE DEMİR) RB2225	YEAR: 2001-->
AU2214A3002 ROT TAKIMI ÖN AKS RB288136	YEAR: 2001-->
AU2318 ROTBAŞI SOL KISA RB2318	CH. NO:-->8L-W-050-422
AU23183003 ROT TAKIMI SAĞ RB288113	CH. NO:--> 8L-W-050-422
AU2319 ROTBAŞI SAĞ KISA RB2319	CH. NO:--> 8L-W-050-422

Ürün Kodu	Bilgi Notu
AU23193003 ROT TAKIMI SOL RB288112	CH. NO:--> 8L-W-050-422
AU3001 ROTMİLİ SOL VE SAĞ 318 RD0908	CH. NO: 8L-W-050-423 ->
AU3003 ROTMİLİ SAĞ-SOL UZUN L 360 MM RB2811	CHASSIS: -> 8L-W-050-422
AU4008 Z ROT ÖN SAĞ ALİMİNYUM 90 RB2921	WITH BOLTS and NUTS
AU4009 Z ROT ÖN SOL ALİMİNYUM 90 RB2920	WITH BOLTS and NUTS
AU5007A SALINCAK ÖN ÜST SAĞ RB2629	CH. NO: 8D-W-006471 --> and 8D-X-200001 -->
AU5008A SALINCAK ÖN ÜST SOL RB2628	CH. NO: 8D-W-006471 --> and 8D-X-200001 -->
AU5009A SALINCAK ÖN ÜST SAĞ RB2635	CH. NO: 8D-W-006471 --> and 8D-X-200001 -->
AU5010A SALINCAK ÖN ÜST SOL RB2634	CH. NO: 8D-W-006471 --> and 8D-X-200001 -->
AU5085 SALINCAK ÖN ÜST ÖNDEN SAĞ	ONLY FOR SPORT SUSPENSION
AU5086 SALINCAK ÖN ÜST ÖNDEN SOL	ONLY FOR SPORT SUSPENSION
AU5087 SALINCAK ÖN ÜST ARKADAN SAĞ	ONLY FOR SPORT SUSPENSION
AU5088 SALINCAK ÖN ÜST ARKADAN SOL	ONLY FOR SPORT SUSPENSION
AU8001 SÜSPANSİYON KİT ÖN	AU2214 (X2) / AU5013 (X2) / OTHER (X1)
FI14014 AKS KÖRÜĞÜ +KELEPÇE+YAĞ. DIŞ	SET = BELOW, CLAMPING CLIP, MOLYBDENUM GREASE / 1.3
SE12001 MOTOR TAKOZU ÖN SOL VE SAĞ	AUDI A1 YEARS ONLY: 2014-2018 / SEAT IBIZA ONLY: IV 2015-2017 / 1,4 TDI / VOLKSWAGEN POLO YEARS ONLY: 2014 -
SE12002 MOTOR TAKOZU ÖN SOL VE SAĞ	SEAT IBIZA ONLY: IV 2015 -2017 / VOLKSWAGEN POLO YEARS ONLY: 2014 -

Ürün Kodu	Bilgi Notu
SE12003 MOTOR TAKOZU ÖN SOL VE SAĞ	1,0 - 1,2 TSI / SEAT IBIZA ONLY: IV 2015 - / VOLKSWAGEN POLO YEARS ONLY: 2014 -
SE12004 MOTOR TAKOZU ÖN SOL VE SAĞ	AUDI A1 YEARS ONLY: 2014-2018 / SEAT IBIZA ONLY: IV 2015-2017 / 1,4 TDI / VOLKSWAGEN POLO YEARS ONLY: 2014 -
SE12005 MOTOR TAKOZU ARKA	SEAT IBIZA YEARS ONLY : 2002-2005
SK11004 SALINCAK VE DENGELER KOLU BURCU SOL VE SAĞ B37114	YEAR: 1993-->
SK12002 AMORTİSÖR TAKOZU ARKA SOL VE SAĞ 1.2 / 1.4TSI / 1.6TDI / 1.2TDI	1.2 / 1.4TSI / 1.6TDI / 1.2TDI
SK12003K VİRAJ DEMİR LASTİĞİ SOL VE SAĞ RUBBER	2 PIECES IN 1 BOX
SK12005 MOTOR TAKOZU ÖN SAĞ	FOR 1.0 TSI
SK14001 AKS KÖRÜĞÜ +KELEPÇE+YAĞ. DIŞ LÖBRO TİPİ	SET = BELOW, CLAMPING CLIP and MOLYBDENUM GREASE / OUTER
SK14002 AKS KÖRÜĞÜ +KELEPÇE+YAĞ. İÇ YENİ MODEL	SET = BELOW, CLAMPING CLIP and MOLYBDENUM GREASE / INNER
SK14003 AKS KÖRÜĞÜ +KELEPÇE+YAĞ. İÇ ESKİ MODEL	SET = BELOW, CLAMPING CLIP and MOLYBDENUM GREASE / INNER
SK20033003 ROT TAKIMI ÖN AKS SAĞ RC788115	*T STEERING
SK20033004 ROT TAKIMI ÖN AKS SAĞ RC788117	KOYO STEERING
SK20043003 ROT TAKIMI SOL RC788114	*T STEERING
SK20043004 ROT TAKIMI ÖN AKS SOL RC788116	KOYO STEERING
SK2006 ROTBAŞI SAĞ	FACELIFT
SK2007 ROTBAŞI SOL	FACELIFT
SK3001 ROTMİLİ ÖN SAĞ - SOL 320	MANUAL STEERING

Ürün Kodu	Bilgi Notu
SK3002 ROTMİLİ ÖN SAĞ - SOL 357	POWER STEERING
SK3003 ROTMİLİ SAĞ-SOL 297	*T STEERING
SK3004 ROTMİLİ SAĞ-SOL 300 RC7817	KOYO STEERING
SK3007 ROTMİLİ SAĞ-SOL	KOYO STEERING
SK6005 SALINCAK ÖN ALT SAĞ RC8013	YEAR: 1994-1997
SK6006 SALINCAK ÖN ALT SOL RC8014	YEAR: 1994-1997
SK6007 SALINCAK ÖN ALT SAĞ RC8018	YEAR: 1998-2001
SK6008 SALINCAK ÖN ALT SOL RC8017	YEAR: 1998-2001
SK8001 SÜSPANSİYON KİT	SK3003 (X2) / AU4001 (X2) / OTHERS (X1)
VW1014 ROTİL ÖN ALT SAĞ Ø15,6 RB2536	WITH ENFORCEMENT METAL
VW1051 ROTİL ALT SAĞ	FOR VEHICLES WITH ALUMINUM WHEEL BEARING
VW1051 ROTİL ALT SAĞ	FOR VEHICLES WITH ALUMINUM WHEEL BEARING
VW1052 ROTİL ALT SOL	FOR VEHICLES WITH ALUMINUM WHEEL BEARING
VW1052 ROTİL ALT SOL	FOR VEHICLES WITH ALUMINUM WHEEL BEARING
VW11043B SALINCAK VE DENGİ KOLU BURCU SAĞ	WITHOUT BUSH
VW11044B SALINCAK VE DENGİ KOLU BURCU SOL	WITHOUT BUSH
VW11052 SALINCAK VE DENGİ KOLU BURCU ALT SOL VE SAĞ B22130	ONLY: A4 - A6 > 1,6-1,8 / PASSAT > 1,6 - 2,8 *

Ürün Kodu	Bilgi Notu
VW11055 SALINCAK VE DENGELER KOLU BURCU İÇ SOL VE SAĞ	ONLY FOR MEXICO MARKET
VW11075 SALINCAK VE DENGELER KOLU BURCU ARKA SOL VE SAĞ	FORWARD and INNER
VW11076 SALINCAK VE DENGELER KOLU BURCU ARKA SOL VE SAĞ	FORWARD and OUTER
VW12020K VİRAJ DEMİR LASTİĞİ SOL VE SAĞ RUBBER	2 PCS
VW12028 MOTOR TAKOZU SOL VE SAĞ MOTOR TAKOZU	1,4 TDI -1,6 TDI
VW12029 MOTOR TAKOZU SOL VE SAĞ MOTOR TAKOZU	1,4 TFSI -1,6 TFSI
VW12031 MOTOR TAKOZU SOL VE SAĞ MOTOR TAKOZU	A4: 2,4-2,8 / A6: 2,4 QUATTRO / SUPERB: 2,8 V6 / PASSAT: 2,8 V6
VW12032 MOTOR TAKOZU SOL VE SAĞ MOTOR TAKOZU	A3: 2,0 FSI / ALTEA: 2,0 FSI / TOLEDO: 2,0 FSI / OCTAVIA: 2,0 FSI / CADDY: 2,0 FSI / GOLF: 2,0 TDI / GTI: 2,0 TDI / JETTA: 2,0 TDI / PASSAT: 2,0 FSI / TOURAN: 2,0 FSI
VW12048K VİRAJ DEMİR LASTİĞİ SOL VE SAĞ RUBBER	2 PCS
VW12049K VİRAJ DEMİR LASTİĞİ SOL VE SAĞ RUBBER	2 PCS
VW12052K VİRAJ DEMİR LASTİĞİ SOL VE SAĞ RUBBER	2 PCS
VW12061K AMORTİSÖR TAKOZU SOL VE SAĞ 2 PCS	2 PCS
VW12062K VİRAJ DEMİR LASTİĞİ SOL VE SAĞ RUBBER	2 PCS
VW12064K VİRAJ DEMİR LASTİĞİ SOL VE SAĞ RUBBER	2 PCS / D=Ø21mm
VW12064K VİRAJ DEMİR LASTİĞİ SOL VE SAĞ RUBBER	2 PCS / D=Ø21mm
VW12086 RADYATÖR TAKOZU SOL VE SAĞ RADYATÖR ÜST LASTİĞİ	FOR RADIATOR UPPER PART
VW12087K VİRAJ DEMİR LASTİĞİ SOL VE SAĞ RUBBER	2 PCS

Ürün Kodu	Bilgi Notu
VW12109K AMORTİSÖR TAKOZU SOL VE SAĞ 2 PCS	2 PCS
VW12117K VİRAJ DEMİR LASTİĞİ SOL VE SAĞ RUBBER	2 PCS
VW12137 VİRAJ DEMİR LASTİĞİ	Ø17mm
VW12137K VİRAJ DEMİR LASTİĞİ	2 PIECES in 1 BOX / Ø17mm
VW12801 AMORTİSÖR TAKOZU SOL VE SAĞ KIT = VW12115 AND VW12109	KIT = VW12115 and VW12109
VW13002K DİREKSİYON KÖRÜĞÜ SOL VE SAĞ 2 PIECES	2 Pieces
VW13006K DİREKSİYON KÖRÜĞÜ SOL VE SAĞ 2 PIECES	2 Pieces
VW14001 AKS KÖRÜĞÜ +KELEPÇE+YAĞ. DIŞ	SET = BELOW, CLAMPING CLIP and MOLYBDENUM GREASE / OUTER
VW14003 AKS KÖRÜĞÜ +KELEPÇE+YAĞ. DIŞ	SET = BELOW, CLAMPING CLIP and MOLYBDENUM GREASE / OUTER
VW14008 AKS KÖRÜĞÜ +KELEPÇE+YAĞ. DIŞ	SET = BELOW, CLAMPING CLIP and MOLYBDENUM GREASE / OUTER
VW14009 AKS KÖRÜĞÜ +KELEPÇE+YAĞ. DIŞ	SET = BELOW, CLAMPING CLIP and MOLYBDENUM GREASE / OUTER
VW14011 AKS KÖRÜĞÜ +KELEPÇE+YAĞ. İÇ	SET = BELOW, CLAMPING CLIP and MOLYBDENUM GREASE / INNER
VW14012 AKS KÖRÜĞÜ +KELEPÇE+YAĞ. DIŞ	SET = BELOW, CLAMPING CLIP and MOLYBDENUM GREASE / OUTER
VW2031 ROTBAŞI SAĞ	FOR VEHICLES WITH DYNAMIC STEERING
VW2032 ROTBAŞI SOL	FOR VEHICLES WITH DYNAMIC STEERING
VW4015K Z ROT SOL VE SAĞ METAL	WITH NUT and SCREW
VW4035 Z ROT ARKA PLASTİK	TRIM LEVEL : MULTILINK REAR AXLE

Ürün Kodu	Bilgi Notu
VW6016 SALINCAK ÖN SAĞ RD10227	ONLY: GASOLINE
VW6016J SALINCAK ÖN ALT SAĞ S737	ONLY: GASOLINE
VW6017 SALINCAK ÖN SOL RD10226	ONLY: GASOLINE
VW6017J SALINCAK ÖN ALT SOL S738	ONLY: GASOLINE
VW6018J SALINCAK ÖN SAĞ RB30211	ONLY: DIESEL
VW6019J SALINCAK ÖN SOL RB30212	ONLY: DIESEL
VW6089 SALINCAK VE DENGE KOLU ÖN ALT SAĞ SAC LEVHA	FOR VEHICLES WITH ALUMINUM WHEEL BEARING
VW6090 SALINCAK VE DENGE KOLU ÖN ALT SOL SAC LEVHA	FOR VEHICLES WITH ALUMINUM WHEEL BEARING
VW8001 SÜSPANSİYON KİT ÖN	AU3001 (X2) / VW4011 (X2) / OTHERS (X1)
VW9005 SALINCAK ARKA ALT ÖNDEN	FORWARD