

RIW

STEERING & SUSPENSION
MANUFACTURER



VOLKS WAGEN PRODUCT CATALOG



Products

- Ball Joint
- Tie Rod End
- Axial Joint
- Link Stabilizer
- Control Arm
- Center Rod
- Stabilizer Mounting
- Suspension Kit
- Bush
- Tie Rod Assembly
- Mounting
- Steering Bellow
- Axle Bellow

autocare™
ASSOCIATION

ACES
AFTERMARKET
EXCHANGE STANDARD

Hakkımızda

RIW, otomotiv yedek parça yenileme sektöründe binek ve hafif ticari araçların süspansiyon ve direksiyon parçalarını yüksek kalitede üreten ve son kullanıcının aracını güvenle kullanmasını amaçlayan ayrıca otomotiv endüstrisine ve ülke ekonomisine fayda sağlamayı kendine ilke edinen bir organizasyondur. Rotil, rotbaşı, rotmili, rot-takımı, zrot, askı rotu, ara rot, denge kolu, salıncak, burç, kauçuk ve takoz ürünlerinin montaj ve üretimlerini gerçekleştiren RIW, dünyadaki en geniş ürün çeşitliliğine sahip süspansiyon ve direksiyon parçaları üreticilerinden biridir.

Ürün çeşitliliğinin genişliği, yüksek ürün kalitesi, uygun fiyatları ve müşteri odaklı çalışmaları sonucunda Türkiye'nin en büyük yedek parça firmaları arasında yer almaktadır. Binek ve hafif ticari araçların süspansiyon ve direksiyon parçaları üretiminde Araştırma ve Geliştirme odaklı çalışmalarını en ileri ve teknolojik şartlarda yürütülmesiyle RIW Türkiye'nin en modern yedek parça üreticisidir.

RIW, firma kültüründe, teknoloji, kalite ve müşteri memnuniyetini ön planda tutularak, Türkiye'de ve dünyanın birçok ülkesinde pazarın güvenle tedarik ettiği bir markadır. RIW, modern üretim tesislerinde bulunan son teknoloji makina parkı avantajıyla tasarımdan üretime, üretimden kaliteye, paketlenmeden sevkiyata, pazarlamadan satışa bütün operasyonel aşamaların yanı sıra satış sonrası hizmetlerini ve bütün bunları sağlarken göz önünde bulundurduğu çalışan memnuniyeti ve güvenliğini her zaman iyiye ve ileriye götürme prensibi sayesinde Dünya genelinde 60 'ın üzerinde ülkede saygı değer bir marka olmayı başarmıştır.

Misyon

Dünya otomotiv yenileme sektörüne yüksek kalitede ve pazarda her zaman ilk kez geliştirilen ürünleri sunmak ve ayrıca pazardaki ürün kalitesini yükseltmek.

Vizyon

İleri teknoloji ve sektörel deneyimin ortaya çıkardığı "RIW Standartlarından" bütün dünyanın faydalanması.

Üretim Stratejisi

Ürün dizaynı, kalıp tasarımı, talaşlı imalat, sıcak ve soğuk dövme, alüminyum dövme, dikey ve yatay kol işleme, salıncak imalatı, kaynak, boyama, kaplama ve paketlenmeden oluşan çeşitli üretim aşamaları hemen hemen her bölümün kendi tesisinde RIW mühendislerinin kontrolünde gerçekleşir. RIW üretimdeki her aşamayı farklı bir ünite olarak kabul eder ve müşteriye en hızlı ve en kaliteli ürünü sunmak için her birimin kendi planlamasını ayrı bir birim olarak hareket etmesi tezini savunur. Bu sayede büyük sermayelere ulaşmanın zor olduğu rekabetçi Pazar şartlarında RIW yatırımlarını kalitenin kontrolü ve yükseltilmesi doğrultusunda gerçekleştirir.

Üretimdeki her aşamanın bir çatı altında toplanmasını amaçlayan zihniyetin tam tersine RIW deneyimli mühendisleri sayesinde hammadde ve yarı mamül tedarikçilerinin sürekli denetlenmesini sağlar ve bu sayede kaliteyi her zaman kontrol altında tutar. Bu sistemle kalite testlerinin her aşamada uygulanması için kullanılan son teknoloji makine ve test cihazları sayesinde RIW müşterisine her zaman %100 kontrol edilmiş ürünler sunar ve ayrıca hem hata riskini sıfıra indirir hem de üretilen mamüllerin maliyetlerini düşürerek müşterisine en yüksek kaliteyi en uygun ve rekabetçi fiyatlarda sunmayı hedefler.

Toplam Kalite Anlayışı

Toplam kalite anlayışını kendine amaç edinen RIW, yapılan yatırımlar ve kalite çalışmaları sonucunda, üretim kapasitesini devamlı arttırmış ve dünya pazarında aranan bir marka haline gelmiştir. Güvenlik parçaları üreticisi olmak bilinciyle hareket eden RIW, yüksek kalitedeki ürünlerini Avrupa, Kuzey Afrika, Ortadoğu, Avustralya, Kuzey ve Güney Amerika da yer alan birçok ülkeye aktif olarak ihraç etmektedir.

Üretimin başlangıcından bitimine kadar olan tüm aşamalarda RIW, ürünlerinin kalitesini yakından takip etmekte ve müşterilerine güvenilir ve yüksek kaliteli ürünlerin sunulduğundan emin olmaktadır. Doğru kaliteyi bulana kadar bütün testler ve işlemler, yüksek deneyime sahip RIW mühendisleri tarafından uygulanmaktadır.

Hakkımızda

RIW, otomotiv yedek parça yenileme sektöründe binek ve hafif ticari araçların süspansiyon ve direksiyon parçalarını yüksek kalitede üreten ve son kullanıcının aracını güvenle kullanmasını amaçlayan ayrıca otomotiv endüstrisine ve ülke ekonomisine fayda sağlamayı kendine ilke edinen bir organizasyondur. Rotil, rotbaşı, rotmili, rot-takımı, zrot, askı rotu, ara rot, denge kolu, salıncak, burç, kauçuk ve takoz ürünlerinin montaj ve üretimlerini gerçekleştiren RIW, dünyadaki en geniş ürün çeşitliliğine sahip süspansiyon ve direksiyon parçaları üreticilerinden biridir.

Ürün çeşitliliğinin genişliği, yüksek ürün kalitesi, uygun fiyatları ve müşteri odaklı çalışmaları sonucunda Türkiye'nin en büyük yedek parça firmaları arasında yer almaktadır. Binek ve hafif ticari araçların süspansiyon ve direksiyon parçaları üretiminde Araştırma ve Geliştirme odaklı çalışmalarını en ileri ve teknolojik şartlarda yürütülmesiyle RIW Türkiye'nin en modern yedek parça üreticisidir.

RIW, firma kültüründe, teknoloji, kalite ve müşteri memnuniyetini ön planda tutularak, Türkiye'de ve dünyanın birçok ülkesinde pazarın güvenle tedarik ettiği bir markadır. RIW, modern üretim tesislerinde bulunan son teknoloji makina parkı avantajıyla tasarımdan üretime, üretimden kaliteye, paketlemeden sevkiyata, pazarlamadan satışa bütün operasyonel aşamaların yanı sıra satış sonrası hizmetlerini ve bütün bunları sağlarken göz önünde bulundurduğu çalışan memnuniyeti ve güvenliğini her zaman iyiye ve ileriye götürme prensibi sayesinde Dünya genelinde 60 'ın üzerinde ülkede saygı değer bir marka olmayı başarmıştır.

Misyon

Dünya otomotiv yenileme sektörüne yüksek kalitede ve pazarda her zaman ilk kez geliştirilen ürünleri sunmak ve ayrıca pazardaki ürün kalitesini yükseltmek.

Vizyon

İleri teknoloji ve sektörel deneyimin ortaya çıkardığı "RIW Standartlarından" bütün dünyanın faydalanması.

Üretim Stratejisi

Ürün dizaynı, kalıp tasarımı, talaşlı imalat, sıcak ve soğuk dövme, alüminyum dövme, dikey ve yatay kol işleme, salıncak imalatı, kaynak, boyama, kaplama ve paketlemeden oluşan çeşitli üretim aşamaları hemen hemen her bölümün kendi tesisinde RIW mühendislerinin kontrolünde gerçekleşir. RIW üretimdeki her aşamayı farklı bir ünite olarak kabul eder ve müşteriye en hızlı ve en kaliteli ürünü sunmak için her birimin kendi planlamasını ayrı bir birim olarak hareket etmesi tezini savunur. Bu sayede büyük sermayelere ulaşmanın zor olduğu rekabetçi Pazar şartlarında RIW yatırımlarını kalitenin kontrolü ve yükseltilmesi doğrultusunda gerçekleştirir.

Üretimdeki her aşamanın bir çatı altında toplanmasını amaçlayan zihniyetin tam tersine RIW deneyimli mühendisleri sayesinde hammadde ve yarı mamül tedarikçilerinin sürekli denetlenmesini sağlar ve bu sayede kaliteyi her zaman kontrol altında tutar. Bu sistemle kalite testlerinin her aşamada uygulanması için kullanılan son teknoloji makine ve test cihazları sayesinde RIW müşterisine her zaman %100 kontrol edilmiş ürünler sunar ve ayrıca hem hata riskini sıfıra indirir hem de üretilen mamüllerin maliyetlerini düşürerek müşterisine en yüksek kaliteyi en uygun ve rekabetçi fiyatlarda sunmayı hedefler.

Toplam Kalite Anlayışı

Toplam kalite anlayışını kendine amaç edinen RIW, yapılan yatırımlar ve kalite çalışmaları sonucunda, üretim kapasitesini devamlı arttırmış ve dünya pazarında aranan bir marka haline gelmiştir. Güvenlik parçaları üreticisi olmak bilinciyle hareket eden RIW, yüksek kalitedeki ürünlerini Avrupa, Kuzey Afrika, Ortadoğu, Avustralya, Kuzey ve Güney Amerika da yer alan birçok ülkeye aktif olarak ihraç etmektedir.

Üretimin başlangıcından bitimine kadar olan tüm aşamalarda RIW, ürünlerinin kalitesini yakından takip etmekte ve müşterilerine güvenilir ve yüksek kaliteli ürünlerin sunulduğundan emin olmaktadır. Doğru kaliteyi buluna kadar bütün testler ve işlemler, yüksek deneyime sahip RIW mühendisleri tarafından uygulanmaktadır.

- The codes which has 6 characters are suspension parts (Additional codes are exceptional)
- The codes which has 7 characters are rubber parts (Additional codes are exceptional)
- There is no any specific code for Rod Assembly.
- Rod Assembly codes are the combine of Tie Rod End and Axial Joint.
- Same parts which are used at the different cars might have the same code.

PE 6 001 J

Brand

AC ACURA	DC DACIA	IS ISUZU	LE LEYLAND	PE PEUGEOT	SM SMART
AF ALFA ROMEO	DW DAEWOO	IV IVECO	LC LINCOLN	PO PORSCHE	SY SSANGYONG
AU AUDI	DH DAIHATSU	JG JAGUAR	LO LOTUS	PR PROTON	SU SUBARU
BW BMW	DO DODGE	JP JEEP	MZ MAZDA	RE RENAULT	SZ SUZUKI
BU BUICK	FI FIAT	KI KIA	ME MERCEDES	RR ROLLS-ROYCE	TO TOYOTA
CD CADILLAC	FO FORD	LD LADA	MC MINI COOPER	RO ROVER	VA VAUXHALL
CV CHEVROLET	HN HONDA	LR LAND ROVER	MI MITSUBISHI	SA SAAB	VW VOLKSWAGEN
CY CHRYSLER	HY HYUNDAI	LV LDV	NS NISSAN	SE SEAT	VO VOLVO
CI CITROËN	IK IKCO	LX LEXUS	OP OPEL	SK SKODA	

PE

Product Group

1 BALL JOINT	7 CENTER ROD & DRAG LINK	23 TIE ROD ASSEMBLY
2 TIE ROD END	8 SUSPENSION KITS	12 MOUNTING & RUBBER SUPPORT
3 AXIAL JOINT (INNER TIE ROD)	9 REAR WISHBONE AND CONTROL ARM	128 MOUNTING or RUBBER SUPPORT KIT
4 LINK STABILIZER	10 BUSH	13 BELLOW STEERING
5 CONTROL ARM	11 BUSH	14 BELLOW DRIVE SHAFT
6 WISHBONE	118 REPAIR & BUSH KIT	

6

Numbers

001 Any Number ■

Option

ADDITIONALS CODES AND MEANINGS

K K FOR BALL JOINTS	B B FOR WISHBONE and CONTROL ARMS
VW1012K 1 = BALL JOINT K = WITH EXTRA ACCESSORIES	BW5005B 5 = CONTROL ARM B = WITHOUT BUSHING
VW1012 1 = BALL JOINT	BW5005 5 = CONTROL ARM (The similar as OE part)
J J FOR WISHBONES	K K FOR MOUNTINGS (RUBBER PARTS)
PE6001J 6 = WISHBONE J = WITHOUT BALL JOINT	CV12005K 12 = MOUNTING K = KIT, 2 PIECES or WITH EXTRA ACCESSORIES
PE6001 6 = WISHBONE (The similar as the OE part)	CV12005 12 = MOUNTING (The similar as OE part)
K K FOR WISHBONES or CONTROL ARMS (5,6 or 9)	A THE PRODUCT HAS DIFFERENT OPTION
BW6005K 6 = WISHBONE K = WITH EXTRA ACCESSORIES	FO4030A 4 = LINK STABILIZER A = OPTION (metal, rubber), plastic etc)
BW6005 6 = WISHBONE	FO4030 4 = LINK STABILIZER (The similar as OE part)

J









RIW®

VOLKSWAGEN

1200 A, 1300 A, 1500
1969 - 1982











Resim	Ürün Kodu ve Açıklaması	Detay	OEM
	VW1003 ROTİL ÖN ALT	Ağırlık : 0,3 kg / 0.661 lb Konik Ölçüsü : Ø14,6 Aşık Diş Çapı : M12X1,25 Rotil Gövde Çapı : Ø38,5	131405371G, 131405371H
	VW1004 ROTİL ÖN ÜST	Ağırlık : 0,315 kg / 0.694 lb Konik Ölçüsü : Ø13,8 Aşık Diş Çapı : M12X1,25 Rotil Gövde Çapı : Ø38,5	131405361E, 131405361F 131405361G, 131405375A

AMAROK
2HA, 2HB, S1B, S6B, S7A, S7E
2010 - 2020

Resim	Ürün Kodu ve Açıklaması	Detay	OEM
	VW1033 ROTİL ALT SOL VE SAĞ	Ağırlık : 0,66 kg / 1.455 lb	2H0407151A*
	VW1034 ROTİL ÖN ÜST SAĞ - SOL	Ağırlık : 0,32 kg / 0.705 lb	Â-2H0407021B*
	VW2001 ROTBAŞI SAĞ RD0347	Ağırlık : 0,87 kg / 1.918 lb Uzunluk : 180 mm / 7.09 inch Gövde Diş Çapı : M14X2 Aşık Diş Çapı : M12X1,75 Aşık Konik Çapı : Ø13,2	7L0422818B, 7L0422818C 7L0422818D, 95534713220
	VW2002 ROTBAŞI SOL RD0346	Ağırlık : 0,87 kg / 1.918 lb Uzunluk : 93 mm / 3.66 inch Gövde Diş Çapı : M16X1,5 Aşık Diş Çapı : M14X1,5 Aşık Konik Çapı : Ø16,6	7L0422817B, 7L0422817C 7L0422817D, 95534713221
	VW3001 ROTMİLİ SAĞ-SOL 288 RD08226	Ağırlık : 0,692 kg / 1.526 lb Uzunluk : 288 mm / 11.34 inch Gövde Diş Çapı : M16X1,5 Aşık Diş Çapı : M16X1,5	1160310016, 7L0422803B 7L0422803C, 7L0422804B 7L0422804C, 7L0422821 7L0422821B, 7L0422821D
	VW20013001 ROT TAKIMI ÖN AKS SAĞ	Ağırlık : 1,285 kg / 2.833 lb Rotbaşı : VW2001 Rotmili : VW3001	7L0422804B, 7L0422804C 7L0422804D, 955347032021
	VW20023001 ROT TAKIMI ÖN AKS SOL	Ağırlık : 1,27 kg / 2.800 lb Rotbaşı : VW2002 Rotmili : VW3001	7L0422803B, 7L0422803C 7L0422803D, 955347032020
	VW4030 Z ROT ÖN L=145	Ağırlık : 0,315 kg / 0.694 lb Uzunluk : 145 mm / 5.71 inch	2H0411317

* Bu sayfada ve katalogdaki tüm araçların adları, markaları, modelleri, sembolleri, logoları, orjinal numaraları (oe) ve diğer üçüncü parti numaraları sadece referans amaçlı kullanılmaktadır.

AMAROK
2HA, 2HB, S1B, S6B, S7A, S7E
2010 - 2020





Resim	Ürün Kodu ve Açıklaması	Detay	OEM
	VW4030A Z ROT ÖN PLASTİK L=145	Ağırlık : 0,195 kg / 0.430 lb Malzeme Türü : Plastik Uzunluk : 145 mm / 5.71 inch	2H0411317B
	VW6043 SALINCAK ÖN ÜST SAĞ	Ağırlık : 2,4 kg / 5.291 lb Malzeme Türü : Sac Metal	2H0407022B
	VW6044 SALINCAK ÖN ÜST SOL	Ağırlık : 2,4 kg / 5.291 lb Malzeme Türü : Sac Metal	2H0407021B
	VW6045 SALINCAK ÖN ALT SAĞ	Ağırlık : 7,41 kg / 16.336 lb Malzeme Türü : Sac Metal	2H0407151A
	VW6045J SALINCAK ÖN ALT SAĞ	Ağırlık : 7 kg / 15.432 lb Malzeme Türü : Sac Metal	2H0407151A*, 2H0407151A
	VW6046 SALINCAK ÖN ALT SOL	Ağırlık : 7,41 kg / 16.336 lb Malzeme Türü : Sac Metal	2H0407152A
	VW6046J SALINCAK ÖN ALT SOL	Ağırlık : 7 kg / 15.432 lb Malzeme Türü : Sac Metal	2H0407152A*, 2H0407152A
	VW11066 SALINCAK VE DENG KOLU BURCU ALT SOL VE SAĞ	Yön : Alt Sol Ve Sağ Ağırlık : 0.32 kg / 0.705 lb	2H0407182A
	VW11067 SALINCAK VE DENG KOLU BURCU ALT SOL VE SAĞ	Yön : Alt Sol Ve Sağ Ağırlık : 0.2 kg / 0.441 lb	2H0412333A
	VW11068 SALINCAK VE DENG KOLU BURCU ÜST SOL VE SAĞ	Yön : Üst Sol Ve Sağ Ağırlık : 0.242 kg / 0.534 lb	2H0407077A
	VW11050 Z-ROT BURCU ÖN SOL VE SAĞ	Şasi (Ön / Arka) : ÖN Yön : Sol Ve Sağ Ağırlık : 0.05 kg / 0.110 lb Uzunluk : VW4030 mm / 0.00 inch Aşık Diş Çapı : VW4030A	2H0411317*, 2H0411317B*

* Bu sayfada ve katalogdaki tüm araçların adları, markaları, modelleri, sembolleri, logoları, orjinal numaraları (oe) ve diğer üçüncü parti numaraları sadece referans amaçlı kullanılmaktadır.

AMAROK
2HA, 2HB, S1B, S6B, S7A, S7E
2010 - 2020

Resim	Ürün Kodu ve Açıklaması	Detay	OEM
	VW12139 VİRAJ DEMİR LASTİĞİ	Şasi (Ön / Arka) : ÖN Ağırlık : 0,083 kg / 0.183 lb	2H0411313B, 2H0411313C 2H0411313D
	VW12139K VİRAJ DEMİR LASTİĞİ	Şasi (Ön / Arka) : ÖN Ağırlık : 0,166 kg / 0.366 lb Not : KİT	2H0411313B, 2H0411313C 2H0411313D
	VW12021 AMORTİSÖR TAKOZU SOL VE SAĞ AMORTİSÖR TAKOZU	Yön : Sol Ve Sağ Ağırlık : 0.91 kg / 2.006 lb Not : AMORTİSÖR TAKOZU	2H0412331

AMAROK
NF
2023 -







Resim	Ürün Kodu ve Açıklaması	Detay	OEM
	VW2038 ROTBAŞI SAĞ 202	Ağırlık : 0,795 kg / 1.753 lb Uzunluk : 202 mm / 7.95 inch	2563593, 2604368 2HJ422811, 2HJ422811D
	VW2039 ROTBAŞI SOL 202	Ağırlık : 0,795 kg / 1.753 lb Uzunluk : 202 mm / 7.95 inch	2563597, 2604548 2HJ422812, 2HJ422812C
	VW3031 ROTMİLİ ÖN	Ağırlık : 0,575 kg / 1.268 lb Uzunluk : 230 mm / 9.06 inch	2HJ422818
	VW4001 Z ROT ÖN METAL	Ağırlık : 0,625 kg / 1.378 lb Malzeme Türü : Metal Uzunluk : 296 mm / 11.65 inch	2649818, 2HJ411316A 2HJ411316C, MB3C3B438DB MB3C3B438DC

AMEO
631
2016 - 2020



Resim	Ürün Kodu ve Açıklaması	Detay	OEM
	SK1025 ROTİL SAĞ	Ağırlık : 0,59 kg / 1.301 lb Konik Ölçüsü : Ø15 Bağlantı Delik Çapı : Ø10,5 Aşık Diş Çapı : M12X1,5	5U0407366A, 6R0407366 6R0407366A, 6R0407366B
	SK1026 ROTİL ÖN ALT SOL Ø15	Ağırlık : 0,59 kg / 1.301 lb Konik Ölçüsü : Ø15 Bağlantı Delik Çapı : Ø10,5 Aşık Diş Çapı : M12X1,5	5U0407365A, 6R0407365 6R0407365A, 6R0407365B

* Bu sayfada ve katalogdaki tüm araçların adları, markaları, modelleri, sembolleri, logoları, orjinal numaraları (oe) ve diğer üçüncü parti numaraları sadece referans amaçlı kullanılmaktadır.

AMEO
631
2016 - 2020









Resim	Ürün Kodu ve Açıklaması	Detay	OEM
	SK2003 ROTBAŞI SAĞ RC7314	Ağırlık : 0,377 kg / 0.831 lb Uzunluk : 93,5 mm / 3.68 inch Gövde Diş Çapı : M14X1,5 Aşık Diş Çapı : M12X1,5 Aşık Konik Çapı : Ø13,5	5Z0423812, 6Q0419812C 6Q0423812, 6Q0423812A 6Q0423812C, 6Q0423812D 6R0423812, 8Z0423811A
	SK2004 ROTBAŞI SOL RC7313	Ağırlık : 0,382 kg / 0.842 lb Uzunluk : 93 mm / 3.66 inch Gövde Diş Çapı : M14X1,5 Aşık Diş Çapı : M12X1,5 Aşık Konik Çapı : Ø13,5	5Z0423811, 6Q0419811C 6Q0423811, 6Q0423811A 6Q0423811C, 6Q0423811D 6R0423811, 8Z0423812A
	SK4004 Z ROT ÖM SAĞ-SOL L=270	Ağırlık : 0,266 kg / 0.586 lb Malzeme Türü : Metal Uzunluk : 270 mm / 10.63 inch	6R0411315
	AU11002 SALINCAK VE DENGE KOLU BURCU ÖN SOL VE SAĞ B22117	Şasi (Ön / Arka) : ÖN Yön : Sol Ve Sağ Ağırlık : 0,108 kg / 0.238 lb	1J0407181, 1J0407181A
	AU11005 SALINCAK VE DENGE KOLU BURCU ÖN ORTA SOL VE SAĞ B40115	Şasi (Ön / Arka) : ÖN Yön : Orta Sol Ve Sağ Ağırlık : 0,111 kg / 0.245 lb Not : VW6014 - VW60614J	191407182, 357407182 357407182F
	VW12036 SÜSPANSİYON TAKOZU SOL VE SAĞ ARKA SÜSPANSİYON TAKOZU	Yön : Sol Ve Sağ Ağırlık : 1.591 kg / 3.508 lb Not : ARKA SÜSPANSİYON TAKOZU	6Q0512131B
	VW12086 RADYATÖR TAKOZU SOL VE SAĞ RADYATÖR ÜST LASTİĞİ	Yön : Sol Ve Sağ Ağırlık : 0.024 kg / 0.053 lb Not : RADYATÖR ÜST LASTİĞİ	1K0121367F

ARTEON
3H7
2017 -

Resim	Ürün Kodu ve Açıklaması	Detay	OEM
	VW1019 ROTİL ÖN SAĞ Ø15,3 RB2538	Ağırlık : 0,555 kg / 1.224 lb Konik Ölçüsü : Ø15,3 Bağlantı Delik Çapı : Ø10,5 Aşık Diş Çapı : M12X1,5	3C0407366A
	VW1020 ROTİL ÖN SOL Ø15,3 RB2539	Ağırlık : 0,555 kg / 1.224 lb Konik Ölçüsü : Ø15,3 Bağlantı Delik Çapı : Ø10,5 Aşık Diş Çapı : M12X1,5	3C0407365A
	VW2008 ROTBAŞI ÖN SAĞ RD0342	Ağırlık : 0,412 kg / 0.908 lb Uzunluk : 95 mm / 3.74 inch Gövde Diş Çapı : M16X1,5 Aşık Diş Çapı : M12X1,5 Aşık Konik Çapı : Ø12,7	1K0423812A, 1K0423812C 1K0423812E, 1K0423812G 1K0423812J, 1K0423812K 1KD423812A











* Bu sayfada ve katalogdaki tüm araçların adları, markaları, modelleri, sembolleri, logoları, orijinal numaraları (oe) ve diğer üçüncü parti numaraları sadece referans amaçlı kullanılmaktadır.

ARTEON
3H7
2017 -

Resim	Ürün Kodu ve Açıklaması	Detay	OEM
	VW2009 ROTBAŞI ÖN SOL RD0343	Ağırlık : 0,412 kg / 0.908 lb Uzunluk : 95 mm / 3.74 inch Gövde Diş Çapı : M16X1,5 Aşık Diş Çapı : M12X1,5 Aşık Konik Çapı : Ø13,5	1K0423811A, 1K0423811C 1K0423811E, 1K0423811G 1K0423811J, 1K0423811K 1KD423811A
	VW3021 ROTMİLİ SAĞ-SOL	Ağırlık : 0,705 kg / 1.554 lb Uzunluk : 330 mm / 12.99 inch	561423810
	VW3026 ROTMİLİ ÖN	Ağırlık : 0,695 kg / 1.532 lb Uzunluk : 350 mm / 13.78 inch	5WA423810D
	VW20083021 ROT TAKIMI ÖN AKS SAĞ	Ağırlık : 1,2 kg / 2.646 lb Rotbaşı : VW2008 Rotmilî : VW3021	561423810, 561423810S1
	VW20093021 ROT TAKIMI ÖN SOL	Ağırlık : 1,2 kg / 2.646 lb Rotbaşı : VW2009 Rotmilî : VW3021	561423810 S2, 561423810
	VW4014 Z ROT ÖN SAĞ-SOL METAL 335 RB2935	Ağırlık : 0,46 kg / 1.014 lb Malzeme Türü : Metal Uzunluk : 335 mm / 13.19 inch Aşık Diş Çapı : M12X1,5	1K0411315B, 1K0411315D 1K0411315J, 1K0411315K 1K0411315R, 5Q0411315A 5Q0411315B
	VW4031 Z ROT ARKA PLASTİK	Ağırlık : 0,15 kg / 0.331 lb Malzeme Türü : Plastik Uzunluk : 70 mm / 2.76 inch Aşık Diş Çapı : M10X1,5	5Q0505465A, 5Q0505465C
	AU9012 SALINCAK ARKA ALT SAĞ	Ağırlık : 1,640 kg / 3.616 lb Malzeme Türü : Sac Metal	5Q0505224D
	AU9013 SALINCAK ARKA ALT SOL	Ağırlık : 1,640 kg / 3.616 lb Malzeme Türü : Sac Metal	5Q0505223D
	SK9002 SALINCAK ALT SOL VE SAĞ	Ağırlık : 2,914 kg / 6.424 lb Malzeme Türü : Sac Metal	3Q0505311C, 3Q0505311D 3Q0505311E
	VW6055 SALINCAK ÖN ALT SAĞ	Ağırlık : 3,768 kg / 8.307 lb Malzeme Türü : Sac Metal	3Q0407152E*, 3Q0407152E 3Q0407152F*, 3Q0407152F 3Q0407154B*, 3Q0407154B

* Bu sayfada ve katalogdaki tüm araçların adları, markaları, modelleri, sembolleri, logoları, orjinal numaraları (oe) ve diğer üçüncü parti numaraları sadece referans amaçlı kullanılmaktadır.

ARTEON
3H7
2017 -

Resim	Ürün Kodu ve Açıklaması	Detay	OEM
	VW6055J SALINCAK ÖN ALT SAĞ	Malzeme Türü : Sac Metal	3Q0407152E, 3Q0407152F 3Q0407154B
	VW6056 SALINCAK ÖN ALT SOL	Ağırlık : 3,768 kg / 8.307 lb Malzeme Türü : Sac Metal	3Q0407151E*, 3Q0407151E 3Q0407151F*, 3Q0407151F 3Q0407153B*, 3Q0407153B
	VW6056J SALINCAK ÖN ALT SOL	Malzeme Türü : Sac Metal	3Q0407151E, 3Q0407151F 3Q0407153B
	VW9004 SALINCAK ARKA	Ağırlık : 1,3 kg / 2.866 lb Malzeme Türü : Sac Metal	5Q0505323C, 5Q0505323D
	VW9006 SALINCAK ALT SAĞ	Ağırlık : 1,992 kg / 4.392 lb Malzeme Türü : Sac Metal	3Q0505224
	VW9007 SALINCAK ALT SOL	Ağırlık : 1,992 kg / 4.392 lb Malzeme Türü : Sac Metal	3Q0505223
	AU11068 SALINCAK VE DENGİ KOLU BURCU ARKA ALT SOL VE SAĞ METAL	Şasi (Ön / Arka) : ARKA Yön : Alt Sol Ve Sağ Ağırlık : 0,201 kg / 0.443 lb Malzeme Türü : Metal	PART OF 5Q0505223D, PART OF 5Q0505224D
	SK11006 SALINCAK VE DENGİ KOLU BURCU ARKA ALT	Şasi (Ön / Arka) : ARKA Yön : Alt Ağırlık : 0,125 kg / 0.276 lb	3Q0505311C*, 3Q0505311D* 3Q0505311E*, 5Q0505171B*
	VW11037 SALINCAK VE DENGİ KOLU BURCU SOL VE SAĞ	Yön : Sol Ve Sağ Ağırlık : 0.11 kg / 0.243 lb	1K0505279A
	VW11042 SALINCAK VE DENGİ KOLU BURCU ORTA SOL VE SAĞ	Yön : Orta Sol Ve Sağ Ağırlık : 0,182 kg / 0.401 lb	1K0407182, 5Q0407182
	VW11056 SALINCAK VE DENGİ KOLU BURCU ARKA SOL VE SAĞ	Şasi (Ön / Arka) : ARKA Yön : Sol Ve Sağ Ağırlık : 0.13 kg / 0.287 lb	1K0505203A, 1K0505323D 1K0505323G, 1K0505323H 1K0505323N, 5Q0505323C

* Bu sayfada ve katalogdaki tüm araçların adları, markaları, modelleri, sembolleri, logoları, orjinal numaraları (oe) ve diğer üçüncü parti numaraları sadece referans amaçlı kullanılmaktadır.

ARTEON
3H7
2017 -

Resim	Ürün Kodu ve Açıklaması	Detay	OEM
	VW11063 SALINCAK VE DENG KOLU BURCU SOL VE SAĐ	Yön : Sol Ve SaĐ AĐırlık : 0.34 kg / 0.750 lb	5Q0407183D, 5Q0407183E
	AU11080 BEŐİK (TRAVERS) BURCU ÖN ALT	Őasi (Ön / Arka) : ÖN Yön : Alt AĐırlık : 0,135 kg / 0.298 lb	5Q0505553
	AU12026 MOTOR TAKOZU ÖN SOL VE SAĐ	Őasi (Ön / Arka) : ÖN Yön : Sol Ve SaĐ AĐırlık : 0,850 kg / 1.874 lb	5Q0199855AD, 5Q0199855J 5Q0199855P, 5Q0199855Q
	VW13006 DİREKSİYON KÖRÜĐÜ	AĐırlık : 0.145 kg / 0.320 lb	1K0423831A, 5C0423831
	VW13006K DİREKSİYON KÖRÜĐÜ SOL VE SAĐ 2 PİECES	AĐırlık : 0.29 kg / 0.639 lb	1K0423831A, 5C0423831

ATLANTIC
I 16
1977 - 1987







Resim	Ürün Kodu ve Açıklaması	Detay	OEM
	VW1006 ROTİL SAĐ RD0513	AĐırlık : 0,35 kg / 0.772 lb BaĐlantı Delik Çapı : Ø7,5	171407365F, 171407365G
	VW2003 ROTBAŐI SAĐ-SOL RD0339	AĐırlık : 0,3 kg / 0.661 lb Uzunluk : 79 mm / 3.11 inch Gövde DiŐ Çapı : M14X1,5 AŐık DiŐ Çapı : M12X1,5 AŐık Konik Çapı : Ø12,3	171419811, 171419811A 171419812, 251419811 32111116463, 477419811 477419815, 94434733300
	VW3002 ROTMİLİ RD0811	AĐırlık : 0,665 kg / 1.466 lb Uzunluk : 342 mm / 13.46 inch Gövde DiŐ Çapı : M22X1,5 AŐık DiŐ Çapı : M14X1,5	171419821, 171419821A
	VW20033002 ROT TAKIMI SOL VE SAĐ	AĐırlık : 0,963 kg / 2.123 lb RotbaŐı : VW2003 Rotmilî : VW3002	171 419 804, 171419804
	VW6001 SALINCAK ÖN ALT SAĐ	AĐırlık : 3,652 kg / 8.051 lb Malzeme Türü : Sac Metal	171407153D

* Bu sayfada ve katalogdaki tüm araçların adları, markaları, modelleri, sembolleri, logoları, orjinal numaraları (oe) ve diĐer üçüncü parti numaraları sadece referans amaçlı kullanılmaktadır.

ATLANTIC
I 16
1977 - 1987

Resim	Ürün Kodu ve Açıklaması	Detay	OEM
	VW6001J SALINCAK ÖN ALT	Ağırlık : 2,236 kg / 4.930 lb Malzeme Türü : Sac Metal	171407153D
	VW6002 SALINCAK ÖN ALT SOL RD1047	Ağırlık : 2,668 kg / 5.882 lb Malzeme Türü : Sac Metal	171407153D
	VW11004 SALINCAK VE DENGE KOLU BURCU SOL VE SAĞ B40112	Yön : Sol Ve Sağ Ağırlık : 0,121 kg / 0.267 lb	171407181, 171407181A
	VW11005 SALINCAK VE DENGE KOLU BURCU ORTA SOL VE SAĞ B40113	Yön : Orta Sol Ve Sağ Ağırlık : 0,087 kg / 0.192 lb	171407182D, 171407182E

ATLAS
2018 -







Resim	Ürün Kodu ve Açıklaması	Detay	OEM
	VW1044 ROTİL ALT SAĞ	Ağırlık : 0,645 kg / 1.422 lb	3QF407366
	VW1045 ROTİL ALT SOL	Ağırlık : 0,645 kg / 1.422 lb	3QF407365
	VW2035 ROTBAŞI SAĞ	Ağırlık : 0,555 kg / 1.224 lb	3QF423812A, 3QF423812B
	VW2036 ROTBAŞI SOL	Ağırlık : 0,555 kg / 1.224 lb	3QF423811A, 3QF423811B
	VW3027 ROTMİLİ ÖN	Ağırlık : 0,875 kg / 1.929 lb Uzunluk : 379 mm / 14.92 inch	3QF423810A, 3QF423810B
	VW4039 Z ROT ARKA PLASTİK	Ağırlık : 0,110 kg / 0.243 lb Malzeme Türü : Plastik Uzunluk : 113 mm / 4.45 inch	3QF505465C

* Bu sayfada ve katalogdaki tüm araçların adları, markaları, modelleri, sembolleri, logoları, orjinal numaraları (oe) ve diğer üçüncü parti numaraları sadece referans amaçlı kullanılmaktadır.

ATLAS
2018 -

Resim	Ürün Kodu ve Açıklaması	Detay	OEM
	VW4014 Z ROT ÖN SAĞ-SOL METAL 335 RB2935	Ağırlık : 0,46 kg / 1.014 lb Malzeme Türü : Metal Uzunluk : 335 mm / 13.19 inch Aşık Diş Çapı : M12X1,5	1K0411315B, 1K0411315D 1K0411315J, 1K0411315K 1K0411315R, 5Q0411315A 5Q0411315B

ATLAS CROSS SPORT
2020 -

Resim	Ürün Kodu ve Açıklaması	Detay	OEM
	VW1044 ROTİL ALT SAĞ	Ağırlık : 0,645 kg / 1.422 lb	3QF407366
	VW1045 ROTİL ALT SOL	Ağırlık : 0,645 kg / 1.422 lb	3QF407365
	VW2035 ROTBAŞI SAĞ	Ağırlık : 0,555 kg / 1.224 lb	3QF423812A, 3QF423812B
	VW2036 ROTBAŞI SOL	Ağırlık : 0,555 kg / 1.224 lb	3QF423811A, 3QF423811B
	VW3027 ROTMİLİ ÖN	Ağırlık : 0,875 kg / 1.929 lb Uzunluk : 379 mm / 14.92 inch	3QF423810A, 3QF423810B
	VW4039 Z ROT ARKA PLASTİK	Ağırlık : 0,110 kg / 0.243 lb Malzeme Türü : Plastik Uzunluk : 113 mm / 4.45 inch	3QF505465C

BEETLE
1964 - 2004









Resim	Ürün Kodu ve Açıklaması	Detay	OEM
	VW1003 ROTİL ÖN ALT	Ağırlık : 0,3 kg / 0.661 lb Konik Ölçüsü : Ø14,6 Aşık Diş Çapı : M12X1,25 Rotil Gövde Çapı : Ø38,5	131405371G, 131405371H
	VW1004 ROTİL ÖN ÜST	Ağırlık : 0,315 kg / 0.694 lb Konik Ölçüsü : Ø13,8 Aşık Diş Çapı : M12X1,25 Rotil Gövde Çapı : Ø38,5	131405361E, 131405361F 131405361G, 131405375A

* Bu sayfada ve katalogdaki tüm araçların adları, markaları, modelleri, sembolleri, logoları, orjinal numaraları (oe) ve diğer üçüncü parti numaraları sadece referans amaçlı kullanılmaktadır.

BEETLE
1964 - 2004

Resim	Ürün Kodu ve Açıklaması	Detay	OEM
	BW2013 ROTBAŞI SAĞ RB3213	Ağırlık : 0,266 kg / 0.586 lb Uzunluk : 80 mm / 3.15 inch Gövde Diş Çapı : M14X1,5 Aşık Diş Çapı : M10X1 Aşık Konik Çapı : Ø12,7	31111127317, 31211135820 32211127917, 32211127918 32211130004, 32211135820
	BW2014 ROTBAŞI RB3214	Ağırlık : 0,268 kg / 0.591 lb Uzunluk : 80 mm / 3.15 inch Gövde Diş Çapı : M14X1,5 Aşık Diş Çapı : M10X1 Aşık Konik Çapı : Ø12,7	32211127318, 32211127918 32211130001, 32211135819

BEETLE
5C1, 5C2
2011 -

Resim	Ürün Kodu ve Açıklaması	Detay	OEM
	VW1014 ROTİL ÖN ALT SAĞ Ø15,6 RB2536	Ağırlık : 0,565 kg / 1.246 lb Konik Ölçüsü : Ø15,6 Bağlantı Delik Çapı : Ø10,5 Aşık Diş Çapı : M12X1,5	1K0407366B, 1K0407366C 1K0407366E, 5Q0407366A
	VW1015 ROTİL ÖN ALT SOL Ø15,6 RB2537	Ağırlık : 0,565 kg / 1.246 lb Konik Ölçüsü : Ø15,6 Bağlantı Delik Çapı : Ø10,5 Aşık Diş Çapı : M12X1,5	1K0407365B, 1K0407365C 1K0407365E, 5Q0407365A
	VW2008 ROTBAŞI ÖN SAĞ RD0342	Ağırlık : 0,412 kg / 0.908 lb Uzunluk : 95 mm / 3.74 inch Gövde Diş Çapı : M16X1,5 Aşık Diş Çapı : M12X1,5 Aşık Konik Çapı : Ø12,7	1K0423812A, 1K0423812C 1K0423812E, 1K0423812G 1K0423812J, 1K0423812K 1KD423812A
	VW2009 ROTBAŞI ÖN SOL RD0343	Ağırlık : 0,412 kg / 0.908 lb Uzunluk : 95 mm / 3.74 inch Gövde Diş Çapı : M16X1,5 Aşık Diş Çapı : M12X1,5 Aşık Konik Çapı : Ø13,5	1K0423811A, 1K0423811C 1K0423811E, 1K0423811G 1K0423811J, 1K0423811K 1KD423811A
	VW3021 ROTMİLİ SAĞ-SOL	Ağırlık : 0,705 kg / 1.554 lb Uzunluk : 330 mm / 12.99 inch	561423810
	VW20083021 ROT TAKIMI ÖN AKS SAĞ	Ağırlık : 1,2 kg / 2.646 lb Rotbaşı : VW2008 Rotmilî : VW3021	561423810, 561423810S1
	VW20093021 ROT TAKIMI ÖN SOL	Ağırlık : 1,2 kg / 2.646 lb Rotbaşı : VW2009 Rotmilî : VW3021	561423810 S2, 561423810
	SK4005 Z ROT ÖM SAĞ-SOL L=335MM	Ağırlık : 0,322 kg / 0.710 lb Malzeme Türü : Metal Uzunluk : 335 mm / 13.19 inch Aşık Diş Çapı : M12X1,5	5Q0411315B

* Bu sayfada ve katalogdaki tüm araçların adları, markaları, modelleri, sembolleri, logoları, orijinal numaraları (oe) ve diğer üçüncü parti numaraları sadece referans amaçlı kullanılmaktadır.

BEETLE
5C1, 5C2
2011 -

Resim	Ürün Kodu ve Açıklaması	Detay	OEM
	SK9001 SALINCAK ARKA ALT	Ağırlık : 0,701 kg / 1.545 lb Malzeme Türü : Sac Metal	1K0501529J
	VW6053 SALINCAK ÖN SAĞ	Ağırlık : 3,77 kg / 8.311 lb Malzeme Türü : Sac Metal	561407152A*
	VW6053J SALINCAK ALT SAĞ	Ağırlık : 3,119 kg / 6.876 lb Malzeme Türü : Sac Metal	561407152A
	VW6054 SALINCAK ÖN SOL	Ağırlık : 3,77 kg / 8.311 lb Malzeme Türü : Sac Metal	561407151A*
	VW6054J SALINCAK ÖN SOL	Ağırlık : 3,119 kg / 6.876 lb Malzeme Türü : Sac Metal	561407151, 561407151A
	VW9002 SALINCAK ÖN TARAF SAĞ	Ağırlık : 1,79 kg / 3.946 lb Malzeme Türü : Sac Metal	1K0505224E, 1K0505224H 1K0505224K
	VW9003 SALINCAK ÖN TARAF SOL	Ağırlık : 1,79 kg / 3.946 lb Malzeme Türü : Sac Metal	1K0505223E, 1K0505223H 1K0505223K
	AU11014 SALINCAK VE DENGE KOLU BURCU ARKA SOL VE SAĞ	Şasi (Ön / Arka) : ARKA Yön : Sol Ve Sağ Ağırlık : 0,192 kg / 0.423 lb	1K0505543A
	AU11052 SALINCAK VE DENGE KOLU BURCU SOL VE SAĞ	Yön : Sol Ve Sağ Ağırlık : 0,178 kg / 0.392 lb	1K0505541B, 1K0505541C 1K0505541D
	AU11088 SALINCAK VE DENGE KOLU BURCU ARKA	Şasi (Ön / Arka) : ARKA Ağırlık : 0,165 kg / 0.364 lb	1K0505541C, 1K0505541D 3C0505541
	VW11037 SALINCAK VE DENGE KOLU BURCU SOL VE SAĞ	Yön : Sol Ve Sağ Ağırlık : 0,11 kg / 0.243 lb	1K0505279A



* Bu sayfada ve katalogdaki tüm araçların adları, markaları, modelleri, sembolleri, logoları, orjinal numaraları (oe) ve diğer üçüncü parti numaraları sadece referans amaçlı kullanılmaktadır.

BEETLE
5C1, 5C2
2011 -







Resim	Ürün Kodu ve Açıklaması	Detay	OEM
	VW11051 SALINCAK VE DENGE KOLU BURCU SOL VE SAĞ	Yön : Sol Ve Sağ Ağırlık : 0.121 kg / 0.267 lb	6Q0407183, 6Q0407183A
	VW11071 SALINCAK VE DENGE KOLU BURCU SOL VE SAĞ	Yön : Sol Ve Sağ Ağırlık : 0,294 kg / 0.648 lb	
	VW12159 TAŞIYICI DESTEK BURÇLARI ARKA SOL VE SAĞ	Şasi (Ön / Arka) : ARKA Yön : Sol Ve Sağ Ağırlık : 0,130 kg / 0.287 lb	1K0505553, 1K0505553A
	VW12017 AMORTİSÖR TAKOZU SOL VE SAĞ AMORTİSÖR TAKOZU	Yön : Sol Ve Sağ Ağırlık : 0.847 kg / 1.867 lb Not : AMORTİSÖR TAKOZU	1K0412331B, 1K0412331C
	VW12109 AMORTİSÖR TAKOZU SOL VE SAĞ AMORTİSÖR RULMANI	Yön : Sol Ve Sağ Ağırlık : 0.26 kg / 0.573 lb Not : AMORTİSÖR RULMANI	6N0412249C, 6N0412249E
	VW12109K AMORTİSÖR TAKOZU SOL VE SAĞ 2 PCS	Yön : Sol Ve Sağ Ağırlık : 0.52 kg / 1.146 lb Not : 2 PCS	6N0412249C, 6N0412249E
	VW12027 MOTOR TAKOZU SOL VE SAĞ MOTOR KULAĞI	Yön : Sol Ve Sağ Ağırlık : 2.02 kg / 4.453 lb Not : MOTOR KULAĞI	1K0199262, 1K0199262CN
	VW12038 SÜSPANSİYON TAKOZU SOL VE SAĞ SUS. ARA YATAK TAKOZ ARKA	Yön : Sol Ve Sağ Ağırlık : 0.12 kg / 0.265 lb Not : SUS. ARA YATAK TAKOZ ARKA	3C0 511 359, 3C0511359
	VW12051 SÜSPANSİYON TAKOZU SOL VE SAĞ LASTİK DAYANAK SÜSPANSİYON	Yön : Sol Ve Sağ Ağırlık : 0.045 kg / 0.099 lb Not : LASTİK DAYANAK SÜSPANSİYON	1K0412303B
	VW12086 RADYATÖR TAKOZU SOL VE SAĞ RADYATÖR ÜST LASTİĞİ	Yön : Sol Ve Sağ Ağırlık : 0.024 kg / 0.053 lb Not : RADYATÖR ÜST LASTİĞİ	1K0121367F
	VW13006 DİREKSİYON KÖRÜĞÜ	Ağırlık : 0.145 kg / 0.320 lb	1K0423831A, 5C0423831

* Bu sayfada ve katalogdaki tüm araçların adları, markaları, modelleri, sembolleri, logoları, orjinal numaraları (oe) ve diğer üçüncü parti numaraları sadece referans amaçlı kullanılmaktadır.

BEETLE 5C1, 5C2 2011 -





Resim	Ürün Kodu ve Açıklaması	Detay	OEM
	VW13006K DİREKSİYON KÖRÜĞÜ SOL VE SAĞ 2 PİECES	Ağırlık : 0.29 kg / 0.639 lb	1K0423831A, 5C0423831
	VW14003 AKS KÖRÜĞÜ +KELEPÇE+YAĞ. DIŞ	Ağırlık : 0.25 kg / 0.551 lb	1K0 498 203, 1K0498203
	AU15001 AMORTİSÖR KÖRÜĞÜ ÖN	Şasi (Ön / Arka) : ÖN Ağırlık : 0,110 kg / 0.243 lb	6N0413175A

BEETLE 9C1, 1C1 1998 - 2010

Resim	Ürün Kodu ve Açıklaması	Detay	OEM
	AU1013 ROTİL ÖN ALT SAĞ - SOL Ø15,5 RB2535	Ağırlık : 0,555 kg / 1.224 lb Konik Ölçüsü : Ø15,5 Bağlantı Delik Çapı : Ø10,7 Aşık Diş Çapı : M12X1,5	8N0.407.365A, 8N0.407.365B 8N0.407.365C, 8N0407365A 8N0407365B, 8N0407365C
	AU1014 ROTİL ALT SAĞ Ø15	Ağırlık : 0,35 kg / 0.772 lb Konik Ölçüsü : Ø15 Bağlantı Delik Çapı : Ø8,5 Aşık Diş Çapı : M12X1,25	1J0407366A, 1J0407366AS 1J0407366B, 1J0407366C 1J0407366D, 1J0407366H
	AU1014K ROTİL ÖN SAĞ Ø15 RB2530	Ağırlık : 0,5 kg / 1.102 lb Konik Ölçüsü : Ø15 Bağlantı Delik Çapı : Ø8,5 Aşık Diş Çapı : M12X1,25	1J0407366, 1J0407366A 1J0407366AS, 1J0407366B 1J0407366C, 1J0407366CS 1J0407366D*, 1J0407366D 1J0407366H, 8Z0407366A
	AU1015 ROTİL SOL	Ağırlık : 0,35 kg / 0.772 lb Konik Ölçüsü : Ø15 Bağlantı Delik Çapı : Ø8,5 Aşık Diş Çapı : M12X1,25	1J0407365A, 1J0407365B 1J0407365C, 1J0407365D
	AU1015K ROTİL ÖN SOL Ø15 RB2529	Ağırlık : 0,5 kg / 1.102 lb Konik Ölçüsü : Ø15 Bağlantı Delik Çapı : Ø8,5 Aşık Diş Çapı : M12X1,25	1J0407365, 1J0407365A* 1J0407365A, 1J0407365AS 1J0407365B*, 1J0407365B 1J0407365C*, 1J0407365C 1J0407365CS, 1J0407365D*
	AU2009 ROTBAŞI SAĞ UZUN RD0332	Ağırlık : 0,37 kg / 0.816 lb Uzunluk : 92 mm / 3.62 inch Gövde Diş Çapı : M14X1,5 Aşık Diş Çapı : M12X1,5 Aşık Konik Çapı : Ø13,3	1J0422812B, 3A0422812B 6R0423812A
	AU2010 ROTBAŞI SOL RD0331	Ağırlık : 0,375 kg / 0.827 lb Uzunluk : 92 mm / 3.62 inch Gövde Diş Çapı : M14X1,5 Aşık Diş Çapı : M12X1,5 Aşık Konik Çapı : Ø13,2	1J0422811B, 1JD422811 3A0422811B, 6R0423811A

* Bu sayfada ve katalogdaki tüm araçların adları, markaları, modelleri, sembolleri, logoları, orjinal numaraları (oe) ve diğer üçüncü parti numaraları sadece referans amaçlı kullanılmaktadır.

BEETLE
9C1, 1C1
1998 - 2010

Resim	Ürün Kodu ve Açıklaması	Detay	OEM
	AU2318 ROTBAŞI SOL KISA RB2318	Ağırlık : 0,312 kg / 0.688 lb Uzunluk : 76 mm / 2.99 inch Gövde Diş Çapı : M14X1,5 Aşık Diş Çapı : M12X1,5 Aşık Konik Çapı : Ø13,4	1J0422811, 1J0422811A
	AU2319 ROTBAŞI SAĞ KISA RB2319	Ağırlık : 0,315 kg / 0.694 lb Uzunluk : 76 mm / 2.99 inch Gövde Diş Çapı : M14X1,5 Aşık Diş Çapı : M12X1,5 Aşık Konik Çapı : Ø13,4	1J0422812, 1J0422812A
	AU3001 ROTMİLİ SOL VE SAĞ 318 RD0908	Ağırlık : 0,622 kg / 1.371 lb Uzunluk : 318 mm / 12.52 inch Gövde Diş Çapı : M16X1,5 Aşık Diş Çapı : M14X1,5	1J0422803B, 1J0422804B 1J0422804E, 1J0422807 1J0422807B, 1J0422821B
	AU3003 ROTMİLİ SAĞ-SOL UZUN L 360 MM RB2811	Ağırlık : 0,629 kg / 1.387 lb Uzunluk : 341 mm / 13.43 inch Gövde Diş Çapı : M16X1,5 Aşık Diş Çapı : M14X1,5	1J0422803A, 1J0422804A 1J0422807A, 1J0422807C 1J0422821, 1J0422821A 1J0822807B
	AU3004 ROTMİLİ	Ağırlık : 0.35 kg / 0.772 lb Uzunluk : 320 mm / 12.60 inch	1J0422810B

VW8001 / Süspansiyon Kit Ön
BEETLE
9C1, 1C1
1998 - 2010

Kit Parçaları

Resim	Ürün Kodu / Adı	OEM	OEM	Ürün Kodu / Adı	Resim
	AU2009 Rotbaşı Sağ Uzun Rd0332	1J0422812B, 3A0422812B 6R0423812A	1J0422811B, 1JD422811 3A0422811B, 6R0423811A	AU2010 Rotbaşı Sol Rd0331	
	AU3001 Rotmili Sol Ve Sağ 318 Rd0908	1J0422803B, 1J0422804B 1J0422804E, 1J0422807 1J0422807B, 1J0422821B	1J0411315E, 1J0411315G 1J0422315G	VW4011 Z Rot Ön Sağ-sol Metal 105 Rd0916	
	AU6008 Salıncak Ön Sağ Rb3011	1J0407151B	1J0407151A	AU6009 Salıncak Ön Sol Rb3012	

VW8003 / Süspansiyon Kit Ön

BEETLE

9C1, 1C1











1998 - 2010



Kit Parçaları





Resim	Ürün Kodu / Adı	OEM	OEM	Ürün Kodu / Adı	Resim
	AU1014 Rotil Alt Sağ Ø15	1J0407366A, 1J0407366AS 1J0407366B, 1J0407366C 1J0407366D, 1J0407366H	1J0407365A, 1J0407365B 1J0407365C, 1J0407365D	AU1015 Rotil Sol	
	AU11002 Salıncak Ve Denge Kolu Burcu Ön Sol Ve Sağ B22117	1J0407181, 1J0407181A	191407182, 357407182 357407182F	AU11005 Salıncak Ve Denge Kolu Burcu Ön Orta Sol Ve Sağ B40115	
	VW4011 Z Rot Ön Sağ-sol Metal 105 Rd0916	1J0411315E, 1J0411315G 1J0422315G			

BEETLE
9C1, 1C1
1998 - 2010

Resim	Ürün Kodu ve Açıklaması	Detay	OEM
	AU20093001 ROT TAKIMI SAĞ	Ağırlık : 0,951 kg / 2.097 lb Rotbaşı : AU2009 Rotmili : AU3001	1H0422804B
	AU20093004 ROT TAKIMI SAĞ KOMPLE	Ağırlık : 1.1 kg / 2.425 lb Rotbaşı : AU2009 Rotmili : AU3004	1J0422804B, 1J0422804C
	AU20103001 ROT TAKIMI SOL	Ağırlık : 0,952 kg / 2.099 lb Rotbaşı : AU2010 Rotmili : AU3001	1H0422803B
	AU20103004 ROT TAKIMI SOL KOMPLE	Ağırlık : 1.1 kg / 2.425 lb Rotbaşı : AU2010 Rotmili : AU3004	1J0422803B, 1J0422803C
	AU23183003 ROT TAKIMI SAĞ RB288113	Ağırlık : 0,945 kg / 2.083 lb Rotbaşı : AU2318 Rotmili : AU3003	1J0422804, 1J0422804A 1J0422804C
	AU23183004 ROT TAKIMI SOL RD088206	Ağırlık : 1.075 kg / 2.370 lb Rotbaşı : AU2318 Rotmili : AU3004	1J0422803B
	AU23193003 ROT TAKIMI SOL RB288112	Ağırlık : 0,94 kg / 2.072 lb Rotbaşı : AU2319 Rotmili : AU3003	1J0422803, 1J0422803A 1J0422803C
	AU23193004 ROT TAKIMI SAĞ RD088207	Ağırlık : 1.1 kg / 2.425 lb Rotbaşı : AU2319 Rotmili : AU3004	1J0422804B
	AU4005 Z ROT ÖN SOL METAL RB2924	Ağırlık : 0,602 kg / 1.327 lb Malzeme Türü : Metal Uzunluk : 335 mm / 13.19 inch Aşık Diş Çapı : M12X1,5	1J0411315D, 1J0411615D
	AU4006 Z ROT ÖN SAĞ METAL RB2923	Ağırlık : 0,282 kg / 0.622 lb Malzeme Türü : Metal Uzunluk : 335 mm / 13.19 inch Aşık Diş Çapı : M12X1,5	1J0411316D
	AU4021 Z ROT SOL VE SAĞ METAL RB2940	Ağırlık : 0,26 kg / 0.573 lb Malzeme Türü : Metal Uzunluk : 175 mm / 6.89 inch Aşık Diş Çapı : M10X1,5	1J0505466, 1J0505466B 1J0505466C

* Bu sayfada ve katalogdaki tüm araçların adları, markaları, modelleri, sembolleri, logoları, orjinal numaraları (oe) ve diğer üçüncü parti numaraları sadece referans amaçlı kullanılmaktadır.

BEETLE
9C1, 1C1
1998 - 2010

Resim	Ürün Kodu ve Açıklaması	Detay	OEM
	VW4010 Z ROT SOL VE SAĞ PLASTİK RD0924	Ağırlık : 0,18 kg / 0.397 lb Malzeme Türü : Plastik Uzunluk : 106 mm / 4.17 inch Aşık Diş Çapı : M10X1,5	1J0411315C, 1J0411315J
	VW4011 Z ROT ÖN SAĞ-SOL METAL 105 RD0916	Ağırlık : 0,258 kg / 0.569 lb Malzeme Türü : Metal Uzunluk : 106 mm / 4.17 inch Aşık Diş Çapı : M10X1,5	1J0411315E, 1J0411315G 1J0422315G
	VW4012 Z ROT ÖN SAĞ METAL RD0937	Ağırlık : 0,437 kg / 0.963 lb Malzeme Türü : Metal Uzunluk : 340 mm / 13.39 inch Aşık Diş Çapı : M12X1,5	68510018
	VW4013 Z ROT ÖN SOL METAL 340 RD0938	Ağırlık : 0,437 kg / 0.963 lb Malzeme Türü : Metal Uzunluk : 340 mm / 13.39 inch Aşık Diş Çapı : M12X1,5	68510017
	VW4020 Z ROT ÖN SAĞ-SOL PLASTİK 105,5	Ağırlık : 0,151 kg / 0.333 lb Malzeme Türü : Plastik Uzunluk : 105 mm / 4.13 inch	1J0411315B, 1J0411315H 1J0411315K
	AU6008 SALINCAK ÖN SAĞ RB3011	Ağırlık : 3,495 kg / 7.705 lb Malzeme Türü : Sac Metal	1J0407151B
	AU6008J SALINCAK ÖN SAĞ RB3101	Ağırlık : 3,212 kg / 7.081 lb Malzeme Türü : Sac Metal	1J0407151C
	AU6009 SALINCAK ÖN SOL RB3012	Ağırlık : 3,495 kg / 7.705 lb Malzeme Türü : Sac Metal	1J0407151A
	SE9003 SALINCAK ALT VE ÜST SOL VE SAĞ	Ağırlık : 1,080 kg / 2.381 lb Malzeme Türü : Sac Metal	1J0505323H, 1J0505323J 1J0505323L, 1J0505323M 1J0505323N
	AU11002 SALINCAK VE DENGİ KOLU BURCU ÖN SOL VE SAĞ B22117	Şasi (Ön / Arka) : ÖN Yön : Sol Ve Sağ Ağırlık : 0,108 kg / 0.238 lb	1J0407181, 1J0407181A
	AU11005 SALINCAK VE DENGİ KOLU BURCU ÖN ORTA SOL VE SAĞ B40115	Şasi (Ön / Arka) : ÖN Yön : Orta Sol Ve Sağ Ağırlık : 0,111 kg / 0.245 lb Not : VW6014 - VW60614J	191407182, 357407182 357407182F

* Bu sayfada ve katalogdaki tüm araçların adları, markaları, modelleri, sembolleri, logoları, orjinal numaraları (oe) ve diğer üçüncü parti numaraları sadece referans amaçlı kullanılmaktadır.

BEETLE
9C1, 1C1
1998 - 2010

Resim	Ürün Kodu ve Açıklaması	Detay	OEM
	VW11036 SALINCAK VE DENGE KOLU BURCU SOL VE SAĞ	Yön : Sol Ve Sağ Ağırlık : 0.07 kg / 0.154 lb Not : BORUSU	191411315B, 4A0399413A
	AU11023 Z-ROT BURCU ARKA	Şasi (Ön / Arka) : ARKA Ağırlık : 0.26 kg / 0.573 lb Uzunluk : AU4021 mm / 0.00 inch Aşık Dış Çapı : VW4017	1J0505466B*
	VW11090 Z-ROT BURCU ÖN	Şasi (Ön / Arka) : ÖN Ağırlık : 0,045 kg / 0.099 lb	1J0411315*, 1J0411315B* 1J0411315C*, 1J0411315E* 1J0411315G*, 1J0411315J*
	VW12010 TORSİYON BURCU SOL VE SAĞ	Yön : Sol Ve Sağ Ağırlık : 0.31 kg / 0.683 lb	1J0500045, 1J0500045A 1J0501541B, 1J0501541C 6R0501541A, 6R0501541B
	VW12016 VİRAJ DEMİR LASTİĞİ SOL VE SAĞ RUBBER	Şasi (Ön / Arka) : ÖN Yön : Sol Ve Sağ Ağırlık : 0.03 kg / 0.066 lb Malzeme Türü : Rubber	1J0411314G, 1J0411314T 8N0411303G, 8N0411303H
	VW12016K VİRAJ DEMİR LASTİĞİ SOL VE SAĞ RUBBER	Şasi (Ön / Arka) : ÖN Yön : Sol Ve Sağ Ağırlık : 0.06 kg / 0.132 lb Malzeme Türü : Rubber Not : İKİLİ	1J0411314G, 1J0411314T 8N0411303G, 8N0411303H
	VW12020 VİRAJ DEMİR LASTİĞİ SOL VE SAĞ RUBBER	Şasi (Ön / Arka) : ÖN Yön : Sol Ve Sağ Ağırlık : 0.07 kg / 0.154 lb Malzeme Türü : Rubber Not : VİRAJ ORTA LASTİĞİ	8D0511327C
	VW12020K VİRAJ DEMİR LASTİĞİ SOL VE SAĞ RUBBER	Şasi (Ön / Arka) : ÖN Yön : Sol Ve Sağ Ağırlık : 0.14 kg / 0.309 lb Malzeme Türü : Rubber	8D0511327C*
	VW12052 VİRAJ DEMİR LASTİĞİ SOL VE SAĞ RUBBER	Şasi (Ön / Arka) : ÖN Yön : Sol Ve Sağ Ağırlık : 0.06 kg / 0.132 lb Malzeme Türü : Rubber Not : VİRAJ LASTİĞİ	1J0411314R
	VW12052K VİRAJ DEMİR LASTİĞİ SOL VE SAĞ RUBBER	Şasi (Ön / Arka) : ÖN Yön : Sol Ve Sağ Ağırlık : 0.12 kg / 0.265 lb Malzeme Türü : Rubber	1J0411314R*
	VW12064 VİRAJ DEMİR LASTİĞİ SOL VE SAĞ RUBBER	Şasi (Ön / Arka) : ÖN Yön : Sol Ve Sağ Ağırlık : 0,023 kg / 0.051 lb Malzeme Türü : Rubber Not : D=Ø21mm	1J0411314C, 1J0411314R











* Bu sayfada ve katalogdaki tüm araçların adları, markaları, modelleri, sembolleri, logoları, orjinal numaraları (oe) ve diğer üçüncü parti numaraları sadece referans amaçlı kullanılmaktadır.

BEETLE
9C1, 1C1
1998 - 2010

Resim	Ürün Kodu ve Açıklaması	Detay	OEM
	VW12064K VİRAJ DEMİR LASTİĞİ SOL VE SAĞ RUBBER	Şasi (Ön / Arka) : ÖN Yön : Sol Ve Sağ Ağırlık : 0.046 kg / 0.101 lb Malzeme Türü : Rubber	1J0411314C*
	VW12117 VİRAJ DEMİR LASTİĞİ SOL VE SAĞ RUBBER	Şasi (Ön / Arka) : ÖN Yön : Sol Ve Sağ Ağırlık : 0.08 kg / 0.176 lb Malzeme Türü : Rubber	1J0411327
	VW12117K VİRAJ DEMİR LASTİĞİ SOL VE SAĞ RUBBER	Şasi (Ön / Arka) : ÖN Yön : Sol Ve Sağ Ağırlık : 0.16 kg / 0.353 lb Malzeme Türü : Rubber	1J0411327
	SK12002 AMORTİSÖR TAKOZU ARKA SOL VE SAĞ 1.2 / 1.4TSI / 1.6TDI / 1.2TDI	Şasi (Ön / Arka) : ARKA Yön : Sol Ve Sağ Ağırlık : 0.305 kg / 0.672 lb Not : 1.2 / 1.4TSI / 1.6TDI / 1.2TDI	1J0513353A, 1J0513353B 1J0513353C, 1J0513353G 6QE513353, 6R0513353 6R0513353B
	VW12061 AMORTİSÖR TAKOZU SOL VE SAĞ AMORTİSÖR TAKOZU	Yön : Sol Ve Sağ Ağırlık : 0.27 kg / 0.595 lb Not : AMORTİSÖR TAKOZU	1H0412365A, 1J0412249 1J0412331BS, 1J0412331C
	VW12061A AMORTİSÖR TAKOZU SOL VE SAĞ AMORTİSOR RULMANI	Yön : Sol Ve Sağ Ağırlık : 0.08 kg / 0.176 lb Not : AMORTİSOR RULMANI	1J0412249, 1J0412249C 357412249, 357412249A 4503300051, 7201688 7201848, 95VW3K031AA
	VW12061K AMORTİSÖR TAKOZU SOL VE SAĞ 2 PCS	Yön : Sol Ve Sağ Ağırlık : 0.7 kg / 1.543 lb Not : 2 PCS	1H0412365A, 1J0412249 1J0412331BS, 1J0412331C
	VW12103 AMORTİSÖR TAKOZU SOL VE SAĞ AMORTİSÖR ÜST TAKOZU	Yön : Sol Ve Sağ Ağırlık : 0.23 kg / 0.507 lb Not : AMORTİSÖR ÜST TAKOZU	1J0412331B, 1J0412331C
	VW12030 MOTOR TAKOZU SOL VE SAĞ MOTOR TAKOZU ARKA	Yön : Sol Ve Sağ Ağırlık : 1.15 kg / 2.535 lb Not : MOTOR TAKOZU ARKA	1J0199851, 1J0199851AK
	VW12040 MOTOR TAKOZU SOL VE SAĞ MOTOR TAKOZU	Yön : Sol Ve Sağ Ağırlık : 1.641 kg / 3.618 lb Not : MOTOR TAKOZU	1J0199555AA, 1J0199555AK
	VW12070 MOTOR TAKOZU SOL VE SAĞ MOTOR TAKOZU	Yön : Sol Ve Sağ Ağırlık : 1.64 kg / 3.616 lb Not : MOTOR TAKOZU	1J0199555AH

* Bu sayfada ve katalogdaki tüm araçların adları, markaları, modelleri, sembolleri, logoları, orijinal numaraları (oe) ve diğer üçüncü parti numaraları sadece referans amaçlı kullanılmaktadır.

BEETLE
9C1, 1C1
1998 - 2010

Resim	Ürün Kodu ve Açıklaması	Detay	OEM
	VW12075 MOTOR TAKOZU SOL VE SAĞ MOTOR TAKOZU	Yön : Sol Ve Sağ Ağırlık : 2.2 kg / 4.850 lb Not : MOTOR TAKOZU	1J0199262BF
	VW12081 MOTOR TAKOZU SOL VE SAĞ MOTOR TAKOZU	Yön : Sol Ve Sağ Ağırlık : 2.04 kg / 4.497 lb Not : MOTOR TAKOZU	1J0199262BK
	VW12084 MOTOR TAKOZU SOL VE SAĞ MOTOR TAKOZU	Yön : Sol Ve Sağ Ağırlık : 2.034 kg / 4.484 lb Not : MOTOR TAKOZU	1J0199262BE
	VW12085 MOTOR TAKOZU SOL VE SAĞ EGZOS TAKOZU	Yön : Sol Ve Sağ Ağırlık : 0.1 kg / 0.220 lb Not : EGZOS TAKOZU	1J0253144G, 1J0802117
	VW12100 MOTOR TAKOZU SOL VE SAĞ MOTOR TAKOZU ARKA	Yön : Sol Ve Sağ Ağırlık : 1.12 kg / 2.469 lb Not : MOTOR TAKOZU ARKA	1J0199851AA, 1J0199851AK 1J0199851M, 1J0199851N
	VW12102 MOTOR TAKOZU SOL VE SAĞ MOTOR TAKOZU	Yön : Sol Ve Sağ Ağırlık : 1.64 kg / 3.616 lb Not : MOTOR TAKOZU	1J0199555AJ, 1J0199555AM 1J0199555AQ, 1J0199555BH
	VW12096 SÜSPANSİYON TAKOZU SOL VE SAĞ SÜSPANSİYON TAKOZU	Yön : Sol Ve Sağ Ağırlık : 0.035 kg / 0.077 lb Not : SÜSPANSİYON TAKOZU	1J0412303
	VW13002 RIW DİREKSİYON KÖRÜĞÜ	Ağırlık : 0.1 kg / 0.220 lb	1J0422831, 1J0422831B 8N0422831
	VW13002K DİREKSİYON KÖRÜĞÜ SOL VE SAĞ 2 PİECES	Ağırlık : 0.2 kg / 0.441 lb	1J0422831, 1J0422831B 8N0422831
	F114014 AKS KÖRÜĞÜ +KELEPÇE+YAĞ. DIŞ	Ağırlık : 0.211 kg / 0.465 lb	46307841
	VW14003 AKS KÖRÜĞÜ +KELEPÇE+YAĞ. DIŞ	Ağırlık : 0.25 kg / 0.551 lb	1K0 498 203, 1K0498203











* Bu sayfada ve katalogdaki tüm araçların adları, markaları, modelleri, sembolleri, logoları, orjinal numaraları (oe) ve diğer üçüncü parti numaraları sadece referans amaçlı kullanılmaktadır.

BJALLA
5C1, 5C2
2011 -

Resim	Ürün Kodu ve Açıklaması	Detay	OEM
	VW1014 ROTİL ÖN ALT SAĞ Ø15,6 RB2536	Ağırlık : 0,565 kg / 1.246 lb Konik Ölçüsü : Ø15,6 Bağlantı Delik Çapı : Ø10,5 Aşık Diş Çapı : M12X1,5	1K0407366B, 1K0407366C 1K0407366E, 5Q0407366A
	VW1015 ROTİL ÖN ALT SOL Ø15,6 RB2537	Ağırlık : 0,565 kg / 1.246 lb Konik Ölçüsü : Ø15,6 Bağlantı Delik Çapı : Ø10,5 Aşık Diş Çapı : M12X1,5	1K0407365B, 1K0407365C 1K0407365E, 5Q0407365A
	VW2008 ROTBAŞI ÖN SAĞ RD0342	Ağırlık : 0,412 kg / 0.908 lb Uzunluk : 95 mm / 3.74 inch Gövde Diş Çapı : M16X1,5 Aşık Diş Çapı : M12X1,5 Aşık Konik Çapı : Ø12,7	1K0423812A, 1K0423812C 1K0423812E, 1K0423812G 1K0423812J, 1K0423812K 1KD423812A
	VW2009 ROTBAŞI ÖN SOL RD0343	Ağırlık : 0,412 kg / 0.908 lb Uzunluk : 95 mm / 3.74 inch Gövde Diş Çapı : M16X1,5 Aşık Diş Çapı : M12X1,5 Aşık Konik Çapı : Ø13,5	1K0423811A, 1K0423811C 1K0423811E, 1K0423811G 1K0423811J, 1K0423811K 1KD423811A
	VW3021 ROTMİLİ SAĞ-SOL	Ağırlık : 0,705 kg / 1.554 lb Uzunluk : 330 mm / 12.99 inch	561423810
	VW20083021 ROT TAKIMI ÖN AKS SAĞ	Ağırlık : 1,2 kg / 2.646 lb Rotbaşı : VW2008 Rotmilî : VW3021	561423810, 561423810S1
	VW20093021 ROT TAKIMI ÖN SOL	Ağırlık : 1,2 kg / 2.646 lb Rotbaşı : VW2009 Rotmilî : VW3021	561423810 S2, 561423810
	VW4014 Z ROT ÖN SAĞ-SOL METAL 335 RB2935	Ağırlık : 0,46 kg / 1.014 lb Malzeme Türü : Metal Uzunluk : 335 mm / 13.19 inch Aşık Diş Çapı : M12X1,5	1K0411315B, 1K0411315D 1K0411315J, 1K0411315K 1K0411315R, 5Q0411315A 5Q0411315B
	VW4015 Z ROT SOL VE SAĞ METAL RB2937	Ağırlık : 0,373 kg / 0.822 lb Malzeme Türü : Metal Uzunluk : 95,5 mm / 3.76 inch Aşık Diş Çapı : M10X1,5	1K0505465C, 1K0505465D 1K0505465H, 1K0505465J 1K0505465K
	VW4015K Z ROT SOL VE SAĞ METAL	Ağırlık : 0,373 kg / 0.822 lb Malzeme Türü : Metal Uzunluk : 95,5 mm / 3.76 inch Aşık Diş Çapı : M10X1,5	1K0505465C, 1K0505465D 1K0505465H, 1K0505465J 1K0505465K
	SK9001 SALINCAK ARKA ALT	Ağırlık : 0,701 kg / 1.545 lb Malzeme Türü : Sac Metal	1K0501529J

* Bu sayfada ve katalogdaki tüm araçların adları, markaları, modelleri, sembolleri, logoları, orjinal numaraları (oe) ve diğer üçüncü parti numaraları sadece referans amaçlı kullanılmaktadır.

BJALLA
5C1, 5C2
2011 -

Resim	Ürün Kodu ve Açıklaması	Detay	OEM
	VW6053 SALINCAK ÖN SAĞ	Ağırlık : 3,77 kg / 8.311 lb Malzeme Türü : Sac Metal	561407152A*
	VW6053J SALINCAK ALT SAĞ	Ağırlık : 3,119 kg / 6.876 lb Malzeme Türü : Sac Metal	561407152A
	VW6054 SALINCAK ÖN SOL	Ağırlık : 3,77 kg / 8.311 lb Malzeme Türü : Sac Metal	561407151A*
	VW6054J SALINCAK ÖN SOL	Ağırlık : 3,119 kg / 6.876 lb Malzeme Türü : Sac Metal	561407151, 561407151A
	VW9002 SALINCAK ÖN TARAF SAĞ	Ağırlık : 1,79 kg / 3.946 lb Malzeme Türü : Sac Metal	1K0505224E, 1K0505224H 1K0505224K
	VW9003 SALINCAK ÖN TARAF SOL	Ağırlık : 1,79 kg / 3.946 lb Malzeme Türü : Sac Metal	1K0505223E, 1K0505223H 1K0505223K
	VW9004 SALINCAK ARKA	Ağırlık : 1,3 kg / 2.866 lb Malzeme Türü : Sac Metal	5Q0505323C, 5Q0505323D
	AU11052 SALINCAK VE DENGİ KOLU BURCU SOL VE SAĞ	Yön : Sol Ve Sağ Ağırlık : 0,178 kg / 0.392 lb	1K0505541B, 1K0505541C 1K0505541D
	AU11088 SALINCAK VE DENGİ KOLU BURCU ARKA	Şasi (Ön / Arka) : ARKA Ağırlık : 0,165 kg / 0.364 lb	1K0505541C, 1K0505541D 3C0505541
	SK11009 SALINCAK VE DENGİ KOLU BURCU ARKA SOL VE SAĞ	Şasi (Ön / Arka) : ARKA Yön : Sol Ve Sağ Ağırlık : 0,176 kg / 0.388 lb	1K0501529J*
	SK11010 SALINCAK VE DENGİ KOLU BURCU ARKA SOL VE SAĞ	Şasi (Ön / Arka) : ARKA Yön : Sol Ve Sağ Ağırlık : 0,196 kg / 0.432 lb Not : BÜYÜK	1K0501529J*

* Bu sayfada ve katalogdaki tüm araçların adları, markaları, modelleri, sembolleri, logoları, orjinal numaraları (oe) ve diğer üçüncü parti numaraları sadece referans amaçlı kullanılmaktadır.

BJALLA
5C1, 5C2
2011 -





Resim	Ürün Kodu ve Açıklaması	Detay	OEM
	VW11056 SALINCAK VE DENGE KOLU BURCU ARKA SOL VE SAĞ	Şasi (Ön / Arka) : ARKA Yön : Sol Ve Sağ Ağırlık : 0.13 kg / 0.287 lb	1K0505203A, 1K0505323D 1K0505323G, 1K0505323H 1K0505323N, 5Q0505323C
	VW11071 SALINCAK VE DENGE KOLU BURCU SOL VE SAĞ	Yön : Sol Ve Sağ Ağırlık : 0,294 kg / 0.648 lb	
	VW11180 Z-ROT BURCU ARKA	Şasi (Ön / Arka) : ARKA Ağırlık : 0.069 kg / 0.152 lb Uzunluk : VW4015 mm / 0.00 inch Aşık Diş Çapı : VW4015K	1K0505465C*, 1K0505465D* 1K0505465H*, 1K0505465J* 1K0505465K*

BORA
1998 - 2005

Resim	Ürün Kodu ve Açıklaması	Detay	OEM
	AU1013 ROTİL ÖN ALT SAĞ - SOL Ø15,5 RB2535	Ağırlık : 0,555 kg / 1.224 lb Konik Ölçüsü : Ø15,5 Bağlantı Delik Çapı : Ø10,7 Aşık Diş Çapı : M12X1,5	8N0.407.365A, 8N0.407.365B 8N0.407.365C, 8N0407365A 8N0407365B, 8N0407365C
	AU1014 ROTİL ALT SAĞ Ø15	Ağırlık : 0,35 kg / 0.772 lb Konik Ölçüsü : Ø15 Bağlantı Delik Çapı : Ø8,5 Aşık Diş Çapı : M12X1,25	1J0407366A, 1J0407366AS 1J0407366B, 1J0407366C 1J0407366D, 1J0407366H
	AU1014K ROTİL ÖN SAĞ Ø15 RB2530	Ağırlık : 0,5 kg / 1.102 lb Konik Ölçüsü : Ø15 Bağlantı Delik Çapı : Ø8,5 Aşık Diş Çapı : M12X1,25	1J0407366, 1J0407366A 1J0407366AS, 1J0407366B 1J0407366C, 1J0407366CS 1J0407366D*, 1J0407366D 1J0407366H, 8Z0407366A
	AU1015 ROTİL SOL	Ağırlık : 0,35 kg / 0.772 lb Konik Ölçüsü : Ø15 Bağlantı Delik Çapı : Ø8,5 Aşık Diş Çapı : M12X1,25	1J0407365A, 1J0407365B 1J0407365C, 1J0407365D
	AU1015K ROTİL ÖN SOL Ø15 RB2529	Ağırlık : 0,5 kg / 1.102 lb Konik Ölçüsü : Ø15 Bağlantı Delik Çapı : Ø8,5 Aşık Diş Çapı : M12X1,25	1J0407365, 1J0407365A* 1J0407365A, 1J0407365AS 1J0407365B*, 1J0407365B 1J0407365C*, 1J0407365C 1J0407365CS, 1J0407365D*
	AU2009 ROTBAŞI SAĞ UZUN RD0332	Ağırlık : 0,37 kg / 0.816 lb Uzunluk : 92 mm / 3.62 inch Gövde Diş Çapı : M14X1,5 Aşık Diş Çapı : M12X1,5 Aşık Konik Çapı : Ø13,3	1J0422812B, 3A0422812B 6R0423812A
	AU2010 ROTBAŞI SOL RD0331	Ağırlık : 0,375 kg / 0.827 lb Uzunluk : 92 mm / 3.62 inch Gövde Diş Çapı : M14X1,5 Aşık Diş Çapı : M12X1,5 Aşık Konik Çapı : Ø13,2	1J0422811B, 1JD422811 3A0422811B, 6R0423811A

* Bu sayfada ve katalogdaki tüm araçların adları, markaları, modelleri, sembolleri, logoları, orijinal numaraları (oe) ve diğer üçüncü parti numaraları sadece referans amaçlı kullanılmaktadır.

BORA
1998 - 2005

Resim	Ürün Kodu ve Açıklaması	Detay	OEM
	AU2318 ROTBAŞI SOL KISA RB2318	Ağırlık : 0,312 kg / 0.688 lb Uzunluk : 76 mm / 2.99 inch Gövde Diş Çapı : M14X1,5 Aşık Diş Çapı : M12X1,5 Aşık Konik Çapı : Ø13,4	1J0422811, 1J0422811A
	AU2319 ROTBAŞI SAĞ KISA RB2319	Ağırlık : 0,315 kg / 0.694 lb Uzunluk : 76 mm / 2.99 inch Gövde Diş Çapı : M14X1,5 Aşık Diş Çapı : M12X1,5 Aşık Konik Çapı : Ø13,4	1J0422812, 1J0422812A
	AU3001 ROTMİLİ SOL VE SAĞ 318 RD0908	Ağırlık : 0,622 kg / 1.371 lb Uzunluk : 318 mm / 12.52 inch Gövde Diş Çapı : M16X1,5 Aşık Diş Çapı : M14X1,5	1J0422803B, 1J0422804B 1J0422804E, 1J0422807 1J0422807B, 1J0422821B
	AU3003 ROTMİLİ SAĞ-SOL UZUN L 360 MM RB2811	Ağırlık : 0,629 kg / 1.387 lb Uzunluk : 341 mm / 13.43 inch Gövde Diş Çapı : M16X1,5 Aşık Diş Çapı : M14X1,5	1J0422803A, 1J0422804A 1J0422807A, 1J0422807C 1J0422821, 1J0422821A 1J0822807B
	AU3004 ROTMİLİ	Ağırlık : 0.35 kg / 0.772 lb Uzunluk : 320 mm / 12.60 inch	1J0422810B

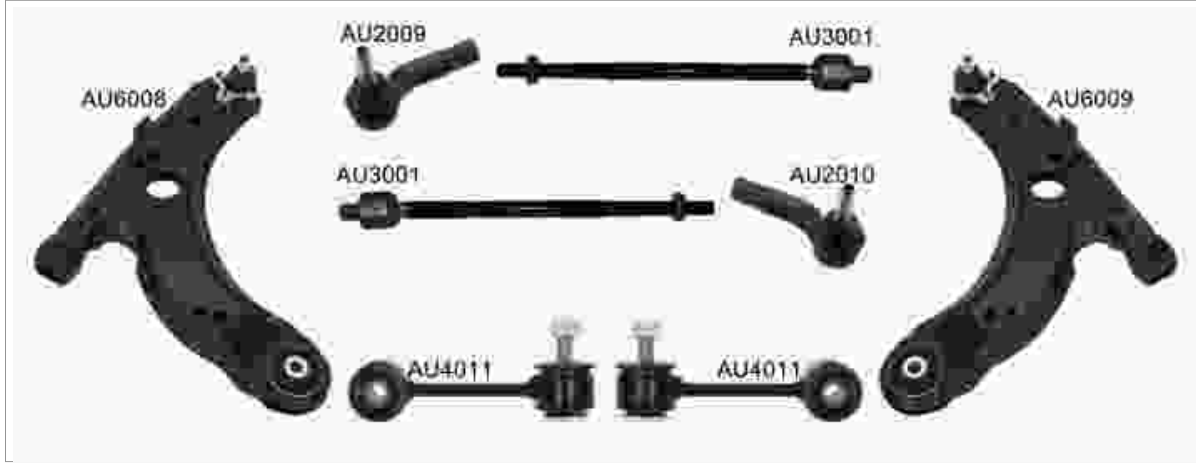
VW8001 / Süspansiyon Kit Ön
BORA
1998 - 2005

Kit Parçaları











Resim	Ürün Kodu / Adı	OEM	OEM	Ürün Kodu / Adı	Resim
	AU2009 Rotbaşı Sağ Uzun Rd0332	1J0422812B, 3A0422812B 6R0423812A	1J0422811B, 1JD422811 3A0422811B, 6R0423811A	AU2010 Rotbaşı Sol Rd0331	
	AU3001 Rotmili Sol Ve Sağ 318 Rd0908	1J0422803B, 1J0422804B 1J0422804E, 1J0422807 1J0422807B, 1J0422821B	1J0411315E, 1J0411315G 1J0422315G	VW4011 Z Rot Ön Sağ-sol Metal 105 Rd0916	
	AU6008 Salıncak Ön Sağ Rb3011	1J0407151B	1J0407151A	AU6009 Salıncak Ön Sol Rb3012	

VW8003 / Süspansiyon Kit Ön
BORA
1998 - 2005

Kit Parçaları



Resim	Ürün Kodu / Adı	OEM	OEM	Ürün Kodu / Adı	Resim
	AU1014 Rotil Alt Sağ Ø15	1J0407366A, 1J0407366AS 1J0407366B, 1J0407366C 1J0407366D, 1J0407366H	1J0407365A, 1J0407365B 1J0407365C, 1J0407365D	AU1015 Rotil Sol	
	AU11002 Salıncak Ve Denge Kolu Burcu Ön Sol Ve Sağ B22117	1J0407181, 1J0407181A	191407182, 357407182 357407182F	AU11005 Salıncak Ve Denge Kolu Burcu Ön Orta Sol Ve Sağ B40115	
	VW4011 Z Rot Ön Sağ-sol Metal 105 Rd0916	1J0411315E, 1J0411315G 1J0422315G			

BORA
1998 - 2005

Resim	Ürün Kodu ve Açıklaması	Detay	OEM
	AU20093001 ROT TAKIMI SAĞ	Ağırlık : 0,951 kg / 2.097 lb Rotbaşı : AU2009 Rotmili : AU3001	1H0422804B
	AU20093004 ROT TAKIMI SAĞ KOMPLE	Ağırlık : 1.1 kg / 2.425 lb Rotbaşı : AU2009 Rotmili : AU3004	1J0422804B, 1J0422804C
	AU20103001 ROT TAKIMI SOL	Ağırlık : 0,952 kg / 2.099 lb Rotbaşı : AU2010 Rotmili : AU3001	1H0422803B
	AU20103004 ROT TAKIMI SOL KOMPLE	Ağırlık : 1.1 kg / 2.425 lb Rotbaşı : AU2010 Rotmili : AU3004	1J0422803B, 1J0422803C
	AU23183003 ROT TAKIMI SAĞ RB288113	Ağırlık : 0,945 kg / 2.083 lb Rotbaşı : AU2318 Rotmili : AU3003	1J0422804, 1J0422804A 1J0422804C
	AU23183004 ROT TAKIMI SOL RD088206	Ağırlık : 1.075 kg / 2.370 lb Rotbaşı : AU2318 Rotmili : AU3004	1J0422803B
	AU23193003 ROT TAKIMI SOL RB288112	Ağırlık : 0,94 kg / 2.072 lb Rotbaşı : AU2319 Rotmili : AU3003	1J0422803, 1J0422803A 1J0422803C
	AU23193004 ROT TAKIMI SAĞ RD088207	Ağırlık : 1.1 kg / 2.425 lb Rotbaşı : AU2319 Rotmili : AU3004	1J0422804B
	AU4005 Z ROT ÖN SOL METAL RB2924	Ağırlık : 0,602 kg / 1.327 lb Malzeme Türü : Metal Uzunluk : 335 mm / 13.19 inch Aşık Diş Çapı : M12X1,5	1J0411315D, 1J0411615D
	AU4006 Z ROT ÖN SAĞ METAL RB2923	Ağırlık : 0,282 kg / 0.622 lb Malzeme Türü : Metal Uzunluk : 335 mm / 13.19 inch Aşık Diş Çapı : M12X1,5	1J0411316D
	AU4021 Z ROT SOL VE SAĞ METAL RB2940	Ağırlık : 0,26 kg / 0.573 lb Malzeme Türü : Metal Uzunluk : 175 mm / 6.89 inch Aşık Diş Çapı : M10X1,5	1J0505466, 1J0505466B 1J0505466C

* Bu sayfada ve katalogdaki tüm araçların adları, markaları, modelleri, sembolleri, logoları, orjinal numaraları (oe) ve diğer üçüncü parti numaraları sadece referans amaçlı kullanılmaktadır.

BORA
1998 - 2005

Resim	Ürün Kodu ve Açıklaması	Detay	OEM
	VW4010 Z ROT SOL VE SAĞ PLASTİK RD0924	Ağırlık : 0,18 kg / 0.397 lb Malzeme Türü : Plastik Uzunluk : 106 mm / 4.17 inch Aşık Diş Çapı : M10X1,5	1J0411315C, 1J0411315J
	VW4011 Z ROT ÖN SAĞ-SOL METAL 105 RD0916	Ağırlık : 0,258 kg / 0.569 lb Malzeme Türü : Metal Uzunluk : 106 mm / 4.17 inch Aşık Diş Çapı : M10X1,5	1J0411315E, 1J0411315G 1J0422315G
	VW4012 Z ROT ÖN SAĞ METAL RD0937	Ağırlık : 0,437 kg / 0.963 lb Malzeme Türü : Metal Uzunluk : 340 mm / 13.39 inch Aşık Diş Çapı : M12X1,5	68510018
	VW4013 Z ROT ÖN SOL METAL 340 RD0938	Ağırlık : 0,437 kg / 0.963 lb Malzeme Türü : Metal Uzunluk : 340 mm / 13.39 inch Aşık Diş Çapı : M12X1,5	68510017
	VW4020 Z ROT ÖN SAĞ-SOL PLASTİK 105,5	Ağırlık : 0,151 kg / 0.333 lb Malzeme Türü : Plastik Uzunluk : 105 mm / 4.13 inch	1J0411315B, 1J0411315H 1J0411315K
	AU6008 SALINCAK ÖN SAĞ RB3011	Ağırlık : 3,495 kg / 7.705 lb Malzeme Türü : Sac Metal	1J0407151B
	AU6008J SALINCAK ÖN SAĞ RB3101	Ağırlık : 3,212 kg / 7.081 lb Malzeme Türü : Sac Metal	1J0407151C
	AU6009 SALINCAK ÖN SOL RB3012	Ağırlık : 3,495 kg / 7.705 lb Malzeme Türü : Sac Metal	1J0407151A
	SE9003 SALINCAK ALT VE ÜST SOL VE SAĞ	Ağırlık : 1,080 kg / 2.381 lb Malzeme Türü : Sac Metal	1J0505323H, 1J0505323J 1J0505323L, 1J0505323M 1J0505323N
	AU11002 SALINCAK VE DENGİ KOLU BURCU ÖN SOL VE SAĞ B22117	Şasi (Ön / Arka) : ÖN Yön : Sol Ve Sağ Ağırlık : 0,108 kg / 0.238 lb	1J0407181, 1J0407181A
	AU11005 SALINCAK VE DENGİ KOLU BURCU ÖN ORTA SOL VE SAĞ B40115	Şasi (Ön / Arka) : ÖN Yön : Orta Sol Ve Sağ Ağırlık : 0,111 kg / 0.245 lb Not : VW6014 - VW60614J	191407182, 357407182 357407182F

* Bu sayfada ve katalogdaki tüm araçların adları, markaları, modelleri, sembolleri, logoları, orjinal numaraları (oe) ve diğer üçüncü parti numaraları sadece referans amaçlı kullanılmaktadır.

BORA
1998 - 2005

Resim	Ürün Kodu ve Açıklaması	Detay	OEM
	VW11036 SALINCAK VE DENGE KOLU BURCU SOL VE SAĞ	Yön : Sol Ve Sağ Ağırlık : 0.07 kg / 0.154 lb Not : BORUSU	191411315B, 4A0399413A
	AU11023 Z-ROT BURCU ARKA	Şasi (Ön / Arka) : ARKA Ağırlık : 0.26 kg / 0.573 lb Uzunluk : AU4021 mm / 0.00 inch Aşık Diş Çapı : VW4017	1J0505466B*
	VW11090 Z-ROT BURCU ÖN	Şasi (Ön / Arka) : ÖN Ağırlık : 0,045 kg / 0.099 lb	1J0411315*, 1J0411315B* 1J0411315C*, 1J0411315E* 1J0411315G*, 1J0411315J*
	VW11008 TAŞIYICI DESTEK BURÇLARI SOL VE SAĞ	Yön : Sol Ve Sağ Ağırlık : 0.24 kg / 0.529 lb	1J0505203, 1J0505365D 1J0505365F, 1J0505365G 1J0505365J, 1J0505365K 1J0505365M, 1J0505365N
	VW12010 TORSİYON BURCU SOL VE SAĞ	Yön : Sol Ve Sağ Ağırlık : 0.31 kg / 0.683 lb	1J0500045, 1J0500045A 1J0501541B, 1J0501541C 6R0501541A, 6R0501541B
	VW12066 TORSİYON BURCU SOL VE SAĞ	Yön : Sol Ve Sağ Ağırlık : 0.6 kg / 1.323 lb	1J0 501 541 D, 1J0501541D
	VW12016 VİRAJ DEMİR LASTİĞİ SOL VE SAĞ RUBBER	Şasi (Ön / Arka) : ÖN Yön : Sol Ve Sağ Ağırlık : 0.03 kg / 0.066 lb Malzeme Türü : Rubber	1J0411314G, 1J0411314T 8N0411303G, 8N0411303H
	VW12016K VİRAJ DEMİR LASTİĞİ SOL VE SAĞ RUBBER	Şasi (Ön / Arka) : ÖN Yön : Sol Ve Sağ Ağırlık : 0.06 kg / 0.132 lb Malzeme Türü : Rubber Not : İKİLİ	1J0411314G, 1J0411314T 8N0411303G, 8N0411303H
	VW12020 VİRAJ DEMİR LASTİĞİ SOL VE SAĞ RUBBER	Şasi (Ön / Arka) : ÖN Yön : Sol Ve Sağ Ağırlık : 0.07 kg / 0.154 lb Malzeme Türü : Rubber Not : VİRAJ ORTA LASTİĞİ	8D0511327C
	VW12020K VİRAJ DEMİR LASTİĞİ SOL VE SAĞ RUBBER	Şasi (Ön / Arka) : ÖN Yön : Sol Ve Sağ Ağırlık : 0.14 kg / 0.309 lb Malzeme Türü : Rubber	8D0511327C*
	VW12047 VİRAJ DEMİR LASTİĞİ SOL VE SAĞ RUBBER	Şasi (Ön / Arka) : ÖN Yön : Sol Ve Sağ Ağırlık : 0.14 kg / 0.309 lb Malzeme Türü : Rubber Not : VİRAJ LASTİĞİ	1J0411314B, 1J0411314S











* Bu sayfada ve katalogdaki tüm araçların adları, markaları, modelleri, sembolleri, logoları, orijinal numaraları (oe) ve diğer üçüncü parti numaraları sadece referans amaçlı kullanılmaktadır.

BORA
1998 - 2005

Resim	Ürün Kodu ve Açıklaması	Detay	OEM
	VW12047K VİRAJ DEMİR LASTİĞİ SOL VE SAĞ RUBBER	Şasi (Ön / Arka) : ÖN Yön : Sol Ve Sağ Ağırlık : 0.28 kg / 0.617 lb Malzeme Türü : Rubber Not : VİRAJ LASTİĞİ (2 ADET)	1J0411314B*, 1J0411314B 1J0411314S*, 1J0411314S
	VW12048 VİRAJ DEMİR LASTİĞİ SOL VE SAĞ RUBBER	Şasi (Ön / Arka) : ÖN Yön : Sol Ve Sağ Ağırlık : 0.03 kg / 0.066 lb Malzeme Türü : Rubber Not : VİRAJ LASTİĞİ	1J0411314P
	VW12048K VİRAJ DEMİR LASTİĞİ SOL VE SAĞ RUBBER	Şasi (Ön / Arka) : ÖN Yön : Sol Ve Sağ Ağırlık : 0.06 kg / 0.132 lb Malzeme Türü : Rubber	1J0411314P*
	VW12052 VİRAJ DEMİR LASTİĞİ SOL VE SAĞ RUBBER	Şasi (Ön / Arka) : ÖN Yön : Sol Ve Sağ Ağırlık : 0.06 kg / 0.132 lb Malzeme Türü : Rubber Not : VİRAJ LASTİĞİ	1J0411314R
	VW12052K VİRAJ DEMİR LASTİĞİ SOL VE SAĞ RUBBER	Şasi (Ön / Arka) : ÖN Yön : Sol Ve Sağ Ağırlık : 0.12 kg / 0.265 lb Malzeme Türü : Rubber	1J0411314R*
	VW12064 VİRAJ DEMİR LASTİĞİ SOL VE SAĞ RUBBER	Şasi (Ön / Arka) : ÖN Yön : Sol Ve Sağ Ağırlık : 0,023 kg / 0.051 lb Malzeme Türü : Rubber Not : D=Ø21mm	1J0411314C, 1J0411314R
	VW12064K VİRAJ DEMİR LASTİĞİ SOL VE SAĞ RUBBER	Şasi (Ön / Arka) : ÖN Yön : Sol Ve Sağ Ağırlık : 0.046 kg / 0.101 lb Malzeme Türü : Rubber	1J0411314C*
	VW12117 VİRAJ DEMİR LASTİĞİ SOL VE SAĞ RUBBER	Şasi (Ön / Arka) : ÖN Yön : Sol Ve Sağ Ağırlık : 0.08 kg / 0.176 lb Malzeme Türü : Rubber	1J0411327
	VW12117K VİRAJ DEMİR LASTİĞİ SOL VE SAĞ RUBBER	Şasi (Ön / Arka) : ÖN Yön : Sol Ve Sağ Ağırlık : 0.16 kg / 0.353 lb Malzeme Türü : Rubber	1J0411327
	SK12002 AMORTİSÖR TAKOZU ARKA SOL VE SAĞ 1.2 / 1.4TSI / 1.6TDI / 1.2TDI	Şasi (Ön / Arka) : ARKA Yön : Sol Ve Sağ Ağırlık : 0.305 kg / 0.672 lb Not : 1.2 / 1.4TSI / 1.6TDI / 1.2TDI	1J0513353A, 1J0513353B 1J0513353C, 1J0513353G 6QE513353, 6R0513353 6R0513353B
	VW12061 AMORTİSÖR TAKOZU SOL VE SAĞ AMORTİSÖR TAKOZU	Yön : Sol Ve Sağ Ağırlık : 0.27 kg / 0.595 lb Not : AMORTİSÖR TAKOZU	1H0412365A, 1J0412249 1J0412331BS, 1J0412331C







* Bu sayfada ve katalogdaki tüm araçların adları, markaları, modelleri, sembolleri, logoları, orijinal numaraları (oe) ve diğer üçüncü parti numaraları sadece referans amaçlı kullanılmaktadır.

BORA
1998 - 2005



Resim	Ürün Kodu ve Açıklaması	Detay	OEM
	VW12061A AMORTİSÖR TAKOZU SOL VE SAĞ AMORTİSÖR RULMANI	Yön : Sol Ve Sağ Ağırlık : 0.08 kg / 0.176 lb Not : AMORTİSÖR RULMANI	1J0412249, 1J0412249C 357412249, 357412249A 4503300051, 7201688 7201848, 95VW3K031AA
	VW12061K AMORTİSÖR TAKOZU SOL VE SAĞ 2 PCS	Yön : Sol Ve Sağ Ağırlık : 0.7 kg / 1.543 lb Not : 2 PCS	1H0412365A, 1J0412249 1J0412331BS, 1J0412331C
	VW12103 AMORTİSÖR TAKOZU SOL VE SAĞ AMORTİSÖR ÜST TAKOZU	Yön : Sol Ve Sağ Ağırlık : 0.23 kg / 0.507 lb Not : AMORTİSÖR ÜST TAKOZU	1J0412331B, 1J0412331C
	VW12030 MOTOR TAKOZU SOL VE SAĞ MOTOR TAKOZU ARKA	Yön : Sol Ve Sağ Ağırlık : 1.15 kg / 2.535 lb Not : MOTOR TAKOZU ARKA	1J0199851, 1J0199851AK
	VW12040 MOTOR TAKOZU SOL VE SAĞ MOTOR TAKOZU	Yön : Sol Ve Sağ Ağırlık : 1.641 kg / 3.618 lb Not : MOTOR TAKOZU	1J0199555AA, 1J0199555AK
	VW12070 MOTOR TAKOZU SOL VE SAĞ MOTOR TAKOZU	Yön : Sol Ve Sağ Ağırlık : 1.64 kg / 3.616 lb Not : MOTOR TAKOZU	1J0199555AH
	VW12075 MOTOR TAKOZU SOL VE SAĞ MOTOR TAKOZU	Yön : Sol Ve Sağ Ağırlık : 2.2 kg / 4.850 lb Not : MOTOR TAKOZU	1J0199262BF
	VW12081 MOTOR TAKOZU SOL VE SAĞ MOTOR TAKOZU	Yön : Sol Ve Sağ Ağırlık : 2.04 kg / 4.497 lb Not : MOTOR TAKOZU	1J0199262BK
	VW12084 MOTOR TAKOZU SOL VE SAĞ MOTOR TAKOZU	Yön : Sol Ve Sağ Ağırlık : 2.034 kg / 4.484 lb Not : MOTOR TAKOZU	1J0199262BE
	VW12085 MOTOR TAKOZU SOL VE SAĞ EGZOS TAKOZU	Yön : Sol Ve Sağ Ağırlık : 0.1 kg / 0.220 lb Not : EGZOS TAKOZU	1J0253144G, 1J0802117
	VW12100 MOTOR TAKOZU SOL VE SAĞ MOTOR TAKOZU ARKA	Yön : Sol Ve Sağ Ağırlık : 1.12 kg / 2.469 lb Not : MOTOR TAKOZU ARKA	1J0199851AA, 1J0199851AK 1J0199851M, 1J0199851N

* Bu sayfada ve katalogdaki tüm araçların adları, markaları, modelleri, sembolleri, logoları, orjinal numaraları (oe) ve diğer üçüncü parti numaraları sadece referans amaçlı kullanılmaktadır.

BORA
1998 - 2005

Resim	Ürün Kodu ve Açıklaması	Detay	OEM
	VW12102 MOTOR TAKOZU SOL VE SAĞ MOTOR TAKOZU	Yön : Sol Ve Sağ Ağırlık : 1.64 kg / 3.616 lb Not : MOTOR TAKOZU	1J0199555AJ, 1J0199555AM 1J0199555AQ, 1J0199555BH
	VW12096 SÜSPANSİYON TAKOZU SOL VE SAĞ SÜSPANSİYON TAKOZU	Yön : Sol Ve Sağ Ağırlık : 0.035 kg / 0.077 lb Not : SÜSPANSİYON TAKOZU	1J0412303
	VW13002 RIW DİREKSİYON KÖRÜĞÜ	Ağırlık : 0.1 kg / 0.220 lb	1J0422831, 1J0422831B 8N0422831
	VW13002K DİREKSİYON KÖRÜĞÜ SOL VE SAĞ 2 PİECES	Ağırlık : 0.2 kg / 0.441 lb	1J0422831, 1J0422831B 8N0422831
	F114014 AKS KÖRÜĞÜ +KELEPÇE+YAĞ. DIŞ	Ağırlık : 0.211 kg / 0.465 lb	46307841
	VW14003 AKS KÖRÜĞÜ +KELEPÇE+YAĞ. DIŞ	Ağırlık : 0.25 kg / 0.551 lb	1K0 498 203, 1K0498203
	VW15002 AMORTİSÖR KÖRÜĞÜ ARKA	Şasi (Ön / Arka) : ARKA	900064

BRASILIA
1973 - 1983

Resim	Ürün Kodu ve Açıklaması	Detay	OEM
	VW1003 ROTİL ÖN ALT	Ağırlık : 0,3 kg / 0.661 lb Konik Ölçüsü : Ø14,6 Aşık Diş Çapı : M12X1,25 Rotil Gövde Çapı : Ø38,5	131405371G, 131405371H
	VW1004 ROTİL ÖN ÜST	Ağırlık : 0,315 kg / 0.694 lb Konik Ölçüsü : Ø13,8 Aşık Diş Çapı : M12X1,25 Rotil Gövde Çapı : Ø38,5	131405361E, 131405361F 131405361G, 131405375A
	BW2013 ROTBAŞI SAĞ RB3213	Ağırlık : 0,266 kg / 0.586 lb Uzunluk : 80 mm / 3.15 inch Gövde Diş Çapı : M14X1,5 Aşık Diş Çapı : M10X1 Aşık Konik Çapı : Ø12,7	31111127317, 31211135820 32211127917, 32211127918 32211130004, 32211135820

* Bu sayfada ve katalogdaki tüm araçların adları, markaları, modelleri, sembolleri, logoları, orjinal numaraları (oe) ve diğer üçüncü parti numaraları sadece referans amaçlı kullanılmaktadır.

BRASILIA
1973 - 1983











Resim	Ürün Kodu ve Açıklaması	Detay	OEM
	BW2014 ROTBAŞI RB3214	Ağırlık : 0,268 kg / 0.591 lb Uzunluk : 80 mm / 3.15 inch Gövde Diş Çapı : M14X1,5 Aşık Diş Çapı : M10X1 Aşık Konik Çapı : Ø12,7	32211127318, 32211127918 32211130001, 32211135819

CADDY
I TYP 14
1974 - 1984

Resim	Ürün Kodu ve Açıklaması	Detay	OEM
	VW1005 ROTİL ALT SOL VE SAĞ RD0512	Ağırlık : 0,346 kg / 0.763 lb Bağlantı Delik Çapı : Ø7,5	171407365C, 171407365D
	VW1006 ROTİL SAĞ RD0513	Ağırlık : 0,35 kg / 0.772 lb Bağlantı Delik Çapı : Ø7,5	171407365F, 171407365G
	VW2003 ROTBAŞI SAĞ-SOL RD0339	Ağırlık : 0,3 kg / 0.661 lb Uzunluk : 79 mm / 3.11 inch Gövde Diş Çapı : M14X1,5 Aşık Diş Çapı : M12X1,5 Aşık Konik Çapı : Ø12,3	171419811, 171419811A 171419812, 251419811 32111116463, 477419811 477419815, 94434733300
	VW3002 ROTMİLİ RD0811	Ağırlık : 0,665 kg / 1.466 lb Uzunluk : 342 mm / 13.46 inch Gövde Diş Çapı : M22X1,5 Aşık Diş Çapı : M14X1,5	171419821, 171419821A
	VW3019 ROTMİLİ ÖN SAĞ - SOL	Ağırlık : 0,55 kg / 1.213 lb Gövde Diş Çapı : M14X1,5 RHT	175422821
	VW20033002 ROT TAKIMI SOL VE SAĞ	Ağırlık : 0,963 kg / 2.123 lb Rotbaşı : VW2003 Rotmilî : VW3002	171 419 804, 171419804
	VW20033019 ROT TAKIMI ÖN AKS RD088145	Ağırlık : 0,85 kg / 1.874 lb Rotbaşı : VW2003 Rotmilî : VW3019	155422803, 155422803A 175422803
	VW6001 SALINCAK ÖN ALT SAĞ	Ağırlık : 3,652 kg / 8.051 lb Malzeme Türü : Sac Metal	171407153D
	VW6001J SALINCAK ÖN ALT	Ağırlık : 2,236 kg / 4.930 lb Malzeme Türü : Sac Metal	171407153D

* Bu sayfada ve katalogdaki tüm araçların adları, markaları, modelleri, sembolleri, logoları, orjinal numaraları (oe) ve diğer üçüncü parti numaraları sadece referans amaçlı kullanılmaktadır.

CADDY
I TYP 14
1974 - 1984

Resim	Ürün Kodu ve Açıklaması	Detay	OEM
	VW6002 SALINCAK ÖN ALT SOL RD1047	Ağırlık : 2,668 kg / 5.882 lb Malzeme Türü : Sac Metal	171407153D
	VW11004 SALINCAK VE DENGE KOLÜ BURCU SOL VE SAĞ B40112	Yön : Sol Ve Sağ Ağırlık : 0,121 kg / 0.267 lb	171407181, 171407181A
	VW11005 SALINCAK VE DENGE KOLÜ BURCU ORTA SOL VE SAĞ B40113	Yön : Orta Sol Ve Sağ Ağırlık : 0,087 kg / 0.192 lb	171407182D, 171407182E
	VW12004 AMORTİSÖR TAKOZU SOL VE SAĞ AMORTİSÖR TABLASI	Yön : Sol Ve Sağ Ağırlık : 0.786 kg / 1.733 lb Not : AMORTİSÖR TABLASI	171412329, 171412329A
	VW12009 MOTOR TAKOZU SOL VE SAĞ MOTOR TAKOZU	Yön : Sol Ve Sağ Ağırlık : 0,288 kg / 0.635 lb Not : MOTOR TAKOZU	171199214D, 171399113D
	VW12091 MOTOR TAKOZU SOL VE SAĞ MOTOR TAKOZU	Yön : Sol Ve Sağ Ağırlık : 0,289 kg / 0.637 lb Not : MOTOR TAKOZU	171199214G
	VW12003 SÜSPANSİYON TAKOZU SOL VE SAĞ AMARTİSÖR TAKOZU ARKA	Yön : Sol Ve Sağ Ağırlık : 0,076 kg / 0.168 lb Not : AMARTİSÖR TAKOZU ARKA	171512131B
	VW12089 SÜSPANSİYON TAKOZU SOL VE SAĞ SÜSPANSİYON TAKOZU	Yön : Sol Ve Sağ Ağırlık : 0.15 kg / 0.331 lb Not : SÜSPANSİYON TAKOZU	191412303A, 357412303E
	AU12012 EGSOZ TAKOZU ÖN SOL VE SAĞ EGSOZ LASTİĞİ	Şasi (Ön / Arka) : ÖN Yön : Sol Ve Sağ Ağırlık : 0.034 kg / 0.075 lb Not : EGSOZ LASTİĞİ	191253147B, 4A0253147A
	VW14013 AKS KÖRÜĞÜ +KELEPÇE+YAĞ. YAĞ+KELEPÇE	Ağırlık : 0.156 kg / 0.344 lb	113501149, 171407283A
	VW14014 AKS KÖRÜĞÜ +KELEPÇE+YAĞ. YAĞ+KELEPÇE	Ağırlık : 0.28 kg / 0.617 lb	191498203C, 71498203



* Bu sayfada ve katalogdaki tüm araçların adları, markaları, modelleri, sembolleri, logoları, orjinal numaraları (oe) ve diğer üçüncü parti numaraları sadece referans amaçlı kullanılmaktadır.

CADDY
II TYP 9K
1995 - 2004

Resim	Ürün Kodu ve Açıklaması	Detay	OEM
	VW1011 ROTİL D= Ø17	Ağırlık : 0,39 kg / 0.860 lb Bağlantı Delik Çapı : Ø8,5	191407365, 191407365B
	VW1011K ROTİL ALT SAĞ-SOL Ø17 RD0514	Ağırlık : 0,435 kg / 0.959 lb Bağlantı Delik Çapı : Ø8,5	191.407.365F, 191407365 191407365B*, 191407365F
	VW1012 ROTİL ALT SOL VE SAĞ	Ağırlık : 0,353 kg / 0.778 lb Bağlantı Delik Çapı : Ø8,5	357407365, 357407365A
	VW1012K ROTİL ALT SAĞ-SOL 19 RD0515	Ağırlık : 0,445 kg / 0.981 lb Bağlantı Delik Çapı : Ø8,5	357407365, 357407365A* 357407365A, 357407365S 357407365-S1
	SE2003 ROTBAŞI SAĞ	Ağırlık : 0,37 kg / 0.816 lb Uzunluk : 92 mm / 3.62 inch Gövde Diş Çapı : M14X1,5 Aşık Diş Çapı : M12X1,5 Aşık Konik Çapı : Ø12,6	1J0422812E, 3A0422812 3A0422812A
	SE2004 ROTBAŞI SOL	Ağırlık : 0,37 kg / 0.816 lb Uzunluk : 92 mm / 3.62 inch Gövde Diş Çapı : M14X1,5 Aşık Diş Çapı : M12X1,5 Aşık Konik Çapı : Ø12,6	1J0422811E, 3A0422811 3A0422811A
	SE3002 ROTMİLİ SOL VE SAĞ 318	Ağırlık : 0,578 kg / 1.274 lb Uzunluk : 318 mm / 12.52 inch	6K0422803D, 6K0422804D 6K0422807D
	VW3004 ROTMİLİ ÖN SAĞ - SOL 338 RD0887	Ağırlık : 0,605 kg / 1.334 lb Uzunluk : 338 mm / 13.31 inch Gövde Diş Çapı : M14X1,5 Aşık Diş Çapı : M14X1,5	191407153, 191422721 191422803A, 191422804A 191422807, 191422807A 191422821, 191422821A 6K0422821
	VW4022 Z ROT ÖN SAĞ-SOL 18MM 75 RD0931	Ağırlık : 0,166 kg / 0.366 lb Malzeme Türü : Metal Uzunluk : 76 mm / 2.99 inch Aşık Diş Çapı : M8X1,25	6N0411315A, 6N0411315D
	VW4025 Z ROT ÖN SAĞ-SOL 15MM 75 RD0925	Ağırlık : 0,173 kg / 0.381 lb Uzunluk : 30 mm / 1.18 inch	6N0411315
	VW6004 SALINCAK ÖN SAĞ	Ağırlık : 3,21 kg / 7.077 lb Malzeme Türü : Sac Metal	191407151A



* Bu sayfada ve katalogdaki tüm araçların adları, markaları, modelleri, sembolleri, logoları, orijinal numaraları (oe) ve diğer üçüncü parti numaraları sadece referans amaçlı kullanılmaktadır.

CADDY
II TYP 9K
1995 - 2004

Resim	Ürün Kodu ve Açıklaması	Detay	OEM
	VW60046005K SALINCAK ÖN	Ağırlık : 3.8 kg / 8.378 lb Malzeme Türü : Sac Metal	
	VW6004J SALINCAK ÖN RD1103	Ağırlık : 2,605 kg / 5.743 lb Malzeme Türü : Sac Metal	191.407.151B, 191407151A 191407151B
	VW6005 SALINCAK ÖN SOL	Ağırlık : 3,21 kg / 7.077 lb Malzeme Türü : Sac Metal	192407151A
	VW6006 SALINCAK ÖN SAĞ RD1019	Ağırlık : 3,166 kg / 6.980 lb Malzeme Türü : Sac Metal	191407151B, 191407175 191411315B, 191411331 357407365A, 6N0411329 N0111849, N10127702
	VW60066007K SALINCAK ÖN	Ağırlık : 3.3 kg / 7.275 lb Malzeme Türü : Sac Metal	
	VW600674008K SALINCAK ÖN	Ağırlık : 3.466 kg / 7.641 lb Malzeme Türü : Sac Metal	
	VW6007 SALINCAK ÖN SOL RD1029	Ağırlık : 3,088 kg / 6.808 lb Malzeme Türü : Sac Metal	191407151A
	AU11005 SALINCAK VE DENGE KOLU BURCU ÖN ORTA SOL VE SAĞ B40115	Şasi (Ön / Arka) : ÖN Yön : Orta Sol Ve Sağ Ağırlık : 0,111 kg / 0.245 lb Not : VW6014 - VW60614J	191407182, 357407182 357407182F
	VW11001 SALINCAK VE DENGE KOLU BURCU SOL VE SAĞ B40114	Yön : Sol Ve Sağ Ağırlık : 0.141 kg / 0.311 lb	191407181D, 191407181E 357407181
	VW12037 VİRAJ DEMİR LASTİĞİ SOL VE SAĞ RUBBER	Şasi (Ön / Arka) : ÖN Yön : Sol Ve Sağ Ağırlık : 0.11 kg / 0.243 lb Malzeme Türü : Rubber Not : VİRAJ DEMİR LASTİĞİ ÖN	191411314
	VW12037K VİRAJ DEMİR LASTİĞİ SOL VE SAĞ RUBBER	Şasi (Ön / Arka) : ÖN Yön : Sol Ve Sağ Ağırlık : 0.22 kg / 0.485 lb Malzeme Türü : Rubber	191411314*







* Bu sayfada ve katalogdaki tüm araçların adları, markaları, modelleri, sembolleri, logoları, orjinal numaraları (oe) ve diğer üçüncü parti numaraları sadece referans amaçlı kullanılmaktadır.

CADDY
II TYP 9K
1995 - 2004





Resim	Ürün Kodu ve Açıklaması	Detay	OEM
	VW12053 VİRAJ DEMİR LASTİĞİ SOL VE SAĞ RUBBER	Şasi (Ön / Arka) : ÖN Yön : Sol Ve Sağ Ağırlık : 0.06 kg / 0.132 lb Malzeme Türü : Rubber Not : VİRAJ LASTİĞİ	1H0411314
	VW12053K VİRAJ DEMİR LASTİĞİ SOL VE SAĞ RUBBER	Şasi (Ön / Arka) : ÖN Yön : Sol Ve Sağ Ağırlık : 0.12 kg / 0.265 lb Malzeme Türü : Rubber	1H0411314*
	VW12111 VİRAJ DEMİR LASTİĞİ SOL VE SAĞ RUBBER	Şasi (Ön / Arka) : ÖN Yön : Sol Ve Sağ Ağırlık : 0.015 kg / 0.033 lb Malzeme Türü : Rubber Not : VİRAJ LASTİĞİ	191411329, 6N0411329
	VW12111K VİRAJ DEMİR LASTİĞİ SOL VE SAĞ RUBBER	Şasi (Ön / Arka) : ÖN Yön : Sol Ve Sağ Ağırlık : 0.03 kg / 0.066 lb Malzeme Türü : Rubber	191411329*, 6N0411329*
	VW12006 AMORTİSÖR TAKOZU SOL VE SAĞ AMORTİSÖR ÜST TAKOZU	Yön : Sol Ve Sağ Ağırlık : 0.445 kg / 0.981 lb Not : AMORTİSÖR ÜST TAKOZU	357412331A, 7201848 7M0412331, 95VW3K031AA
	VW12008 MOTOR TAKOZU SOL VE SAĞ MOTOR TAKOZU	Yön : Sol Ve Sağ Ağırlık : 0.574 kg / 1.265 lb Not : MOTOR TAKOZU	357199381C, 357199402B 3A0199402
	VW12074 MOTOR TAKOZU SOL VE SAĞ MOTOR TAKOZU	Yön : Sol Ve Sağ Ağırlık : 1.08 kg / 2.381 lb Not : MOTOR TAKOZU	1H0199609B, 1H0199609F 1H0199609G, 1H0199609J
	VW12092 MOTOR TAKOZU SAĞ MOTOR TAKOZU ARKA SAĞ	Yön : Sağ Ağırlık : 1,745 kg / 3.847 lb Not : MOTOR TAKOZU ARKA SAĞ	1H0199262B, 1H0199262G 1H0199262H
	VW12098 MOTOR TAKOZU SOL VE SAĞ MOTOR TAKOZU	Yön : Sol Ve Sağ Ağırlık : 1,565 kg / 3.450 lb Not : MOTOR TAKOZU	1H0199262E
	AU12012 EGSOZ TAKOZU ÖN SOL VE SAĞ EGSOZ LASTİĞİ	Şasi (Ön / Arka) : ÖN Yön : Sol Ve Sağ Ağırlık : 0.034 kg / 0.075 lb Not : EGSOZ LASTİĞİ	191253147B, 4A0253147A
	VW12135 EGSOZ TAKOZU	Ağırlık : 0,155 kg / 0.342 lb	1H0253144, 1H0253144A 1H0253144C, 1H0253409C 6N0253144

* Bu sayfada ve katalogdaki tüm araçların adları, markaları, modelleri, sembolleri, logoları, orjinal numaraları (oe) ve diğer üçüncü parti numaraları sadece referans amaçlı kullanılmaktadır.

CADDY
II TYP 9K
1995 - 2004











Resim	Ürün Kodu ve Açıklaması	Detay	OEM
	VW13007 DİREKSİYON KÖRÜĞÜ	Ağırlık : 0.128 kg / 0.282 lb	6N0422831
	VW13008 DİREKSİYON KÖRÜĞÜ	Ağırlık : 0.225 kg / 0.496 lb	1H0422831B
	VW13010 DİREKSİYON KÖRÜĞÜ ÖN	Ağırlık : 0,124 kg / 0.273 lb	191422831
	RN14006 AKS KÖRÜĞÜ +KELEPÇE+YAĞ. DIŞ	Ağırlık : 0.2 kg / 0.441 lb	1603180, 1603204 16410170470106*, 16500170470106* 1H0498203, 271648 271649, 321498203A
	VW14013 AKS KÖRÜĞÜ +KELEPÇE+YAĞ. YAĞ+KELEPÇE	Ağırlık : 0.156 kg / 0.344 lb	113501149, 171407283A
	VW14014 AKS KÖRÜĞÜ +KELEPÇE+YAĞ. YAĞ+KELEPÇE	Ağırlık : 0.28 kg / 0.617 lb	191498203C, 71498203

CADDY
III TYP 2K
2004 - 2020

Resim	Ürün Kodu ve Açıklaması	Detay	OEM
	VW1014 ROTİL ÖN ALT SAĞ Ø15,6 RB2536	Ağırlık : 0,565 kg / 1.246 lb Konik Ölçüsü : Ø15,6 Bağlantı Delik Çapı : Ø10,5 Aşık Diş Çapı : M12X1,5	1K0407366B, 1K0407366C 1K0407366E, 5Q0407366A
	VW1015 ROTİL ÖN ALT SOL Ø15,6 RB2537	Ağırlık : 0,565 kg / 1.246 lb Konik Ölçüsü : Ø15,6 Bağlantı Delik Çapı : Ø10,5 Aşık Diş Çapı : M12X1,5	1K0407365B, 1K0407365C 1K0407365E, 5Q0407365A
	VW2008 ROTBAŞI ÖN SAĞ RD0342	Ağırlık : 0,412 kg / 0.908 lb Uzunluk : 95 mm / 3.74 inch Gövde Diş Çapı : M16X1,5 Aşık Diş Çapı : M12X1,5 Aşık Konik Çapı : Ø12,7	1K0423812A, 1K0423812C 1K0423812E, 1K0423812G 1K0423812J, 1K0423812K 1KD423812A
	VW2009 ROTBAŞI ÖN SOL RD0343	Ağırlık : 0,412 kg / 0.908 lb Uzunluk : 95 mm / 3.74 inch Gövde Diş Çapı : M16X1,5 Aşık Diş Çapı : M12X1,5 Aşık Konik Çapı : Ø13,5	1K0423811A, 1K0423811C 1K0423811E, 1K0423811G 1K0423811J, 1K0423811K 1KD423811A











* Bu sayfada ve katalogdaki tüm araçların adları, markaları, modelleri, sembolleri, logoları, orjinal numaraları (oe) ve diğer üçüncü parti numaraları sadece referans amaçlı kullanılmaktadır.

CADDY
III TYP 2K
2004 - 2020

Resim	Ürün Kodu ve Açıklaması	Detay	OEM
	VW3009 ROTMİLİ SAĞ-SOL 310 RB2838	Ağırlık : 0,665 kg / 1.466 lb Uzunluk : 311 mm / 12.24 inch Gövde Diş Çapı : M16X1,5 Aşık Diş Çapı : M16X1,5	1K0423810A
	SE20033002 ROT TAKIMI ÖN AKS SAĞ	Ağırlık : 0,96 kg / 2.116 lb Rotbaşı : SE2003 Rotmili : SE3002	6K0422804A, 6K0422804D
	SE20043002 ROT TAKIMI ÖN AKS SOL	Ağırlık : 0,96 kg / 2.116 lb Rotbaşı : SE2004 Rotmili : SE3002	6K0422803A, 6K0422803D
	VW20083009 ROT TAKIMI ÖN AKS SAĞ RB288137	Ağırlık : 1,078 kg / 2.377 lb Rotbaşı : VW2008 Rotmili : VW3009	
	VW20093009 ROT TAKIMI ÖN SOL RB288138	Ağırlık : 1,077 kg / 2.374 lb Rotbaşı : VW2009 Rotmili : VW3009	
	SK4005 Z ROT ÖM SAĞ-SOL L=335MM	Ağırlık : 0,322 kg / 0.710 lb Malzeme Türü : Metal Uzunluk : 335 mm / 13.19 inch Aşık Diş Çapı : M12X1,5	5Q0411315B
	VW4014 Z ROT ÖN SAĞ-SOL METAL 335 RB2935	Ağırlık : 0,46 kg / 1.014 lb Malzeme Türü : Metal Uzunluk : 335 mm / 13.19 inch Aşık Diş Çapı : M12X1,5	1K0411315B, 1K0411315D 1K0411315J, 1K0411315K 1K0411315R, 5Q0411315A 5Q0411315B
	VW4015 Z ROT SOL VE SAĞ METAL RB2937	Ağırlık : 0,373 kg / 0.822 lb Malzeme Türü : Metal Uzunluk : 95,5 mm / 3.76 inch Aşık Diş Çapı : M10X1,5	1K0505465C, 1K0505465D 1K0505465H, 1K0505465J 1K0505465K
	VW4015K Z ROT SOL VE SAĞ METAL	Ağırlık : 0,373 kg / 0.822 lb Malzeme Türü : Metal Uzunluk : 95,5 mm / 3.76 inch Aşık Diş Çapı : M10X1,5	1K0505465C, 1K0505465D 1K0505465H, 1K0505465J 1K0505465K
	VW4016 Z ROT ARKA METAL 243 RD0945	Ağırlık : 0,384 kg / 0.847 lb Malzeme Türü : Metal Uzunluk : 241 mm / 9.49 inch Aşık Diş Çapı : M12X1,5	2K0505465B, 2K0505465C 2K0505465E
	AU6010 SALINCAK ÜST SOL VE SAĞ RA5155	Ağırlık : 1,298 kg / 2.862 lb Malzeme Türü : Sac Metal	1K0505323H, 1K0505323N









* Bu sayfada ve katalogdaki tüm araçların adları, markaları, modelleri, sembolleri, logoları, orjinal numaraları (oe) ve diğer üçüncü parti numaraları sadece referans amaçlı kullanılmaktadır.

CADDY
III TYP 2K
2004 - 2020

Resim	Ürün Kodu ve Açıklaması	Detay	OEM
	SE9001 SALINCAK ALT SAĞ RA5150	Ağırlık : 1 kg / 2.205 lb Malzeme Türü : Sac Metal	1K0501530C
	SE9002 SALINCAK ALT SOL RA5151	Ağırlık : 1 kg / 2.205 lb Malzeme Türü : Sac Metal	1K0501529F
	SK9001 SALINCAK ARKA ALT	Ağırlık : 0,701 kg / 1.545 lb Malzeme Türü : Sac Metal	1K0501529J
	VW6016 SALINCAK ÖN SAĞ RD10227	Ağırlık : 4,543 kg / 10.016 lb Malzeme Türü : Sac Metal	1K0407152P, 1K0407152Q* 1K0407152Q
	VW6016J SALINCAK ÖN ALT SAĞ S737	Ağırlık : 4,015 kg / 8.852 lb Malzeme Türü : Sac Metal	1K0407151P, 1K0407151Q 1K0407152P, 1K0407152Q
	VW6017 SALINCAK ÖN SOL RD10226	Ağırlık : 4,543 kg / 10.016 lb Malzeme Türü : Sac Metal	1K0407151M*, 1K0407151P 1K0407151Q*, 1K0407151Q
	VW6017J SALINCAK ÖN ALT SOL S738	Ağırlık : 4,015 kg / 8.852 lb Malzeme Türü : Sac Metal	1K0407151P, 1K0407151Q 1K0407152P, 1K0407152Q
	VW6018J SALINCAK ÖN SAĞ RB30211	Ağırlık : 4,232 kg / 9.330 lb Malzeme Türü : Döküm Çelik	1K0407152AC, 1K0407152M 1K0407152R
	VW6019J SALINCAK ÖN SOL RB30212	Ağırlık : 4,232 kg / 9.330 lb Malzeme Türü : Döküm Çelik	1K0407151AC, 1K0407151M 1K0407151R
	VW6049 SALINCAK ÖN SAĞ	Ağırlık : 3,48 kg / 7.672 lb Malzeme Türü : Sac Metal	1K0407152BB*, 1K0407152BE* 1K0407152BG*
	VW6049J SALINCAK ÖN SAĞ	Ağırlık : 2,87 kg / 6.327 lb Malzeme Türü : Sac Metal	1K0407152BB, 1K0407152BE 1K0407152BG











* Bu sayfada ve katalogdaki tüm araçların adları, markaları, modelleri, sembolleri, logoları, orjinal numaraları (oe) ve diğer üçüncü parti numaraları sadece referans amaçlı kullanılmaktadır.

CADDY
III TYP 2K
2004 - 2020

Resim	Ürün Kodu ve Açıklaması	Detay	OEM
	VW6050 SALINCAK ÖN SOL	Ağırlık : 3,48 kg / 7.672 lb Malzeme Türü : Sac Metal	1K0407151BB*, 1K0407151BG* K0407151BE*
	VW6050J SALINCAK ÖN SOL	Ağırlık : 2,87 kg / 6.327 lb Malzeme Türü : Sac Metal	1K0407151BB, 1K0407151BE 1K0407151BG
	AU11052 SALINCAK VE DENGE KOLU BURCU SOL VE SAĞ	Yön : Sol Ve Sağ Ağırlık : 0,178 kg / 0.392 lb	1K0505541B, 1K0505541C 1K0505541D
	SK11009 SALINCAK VE DENGE KOLU BURCU ARKA SOL VE SAĞ	Şasi (Ön / Arka) : ARKA Yön : Sol Ve Sağ Ağırlık : 0,176 kg / 0.388 lb	1K0501529J*
	SK11010 SALINCAK VE DENGE KOLU BURCU ARKA SOL VE SAĞ	Şasi (Ön / Arka) : ARKA Yön : Sol Ve Sağ Ağırlık : 0,196 kg / 0.432 lb Not : BÜYÜK	1K0501529J*
	VW11042 SALINCAK VE DENGE KOLU BURCU ORTA SOL VE SAĞ	Yön : Orta Sol Ve Sağ Ağırlık : 0,182 kg / 0.401 lb	1K0407182, 5Q0407182
	VW11043 SALINCAK VE DENGE KOLU BURCU SAĞ B22141	Yön : Sağ Diğer Taraf : VW11044 Ağırlık : 0,659 kg / 1.453 lb	1K0199232G, 1K0199232H 1K0199232J
	VW11043B SALINCAK VE DENGE KOLU BURCU SAĞ	Yön : Sağ Diğer Taraf : VW11044B Ağırlık : 0,659 kg / 1.453 lb Not : İÇ BURÇSUZ	1K0199232G, 1K0199232H 1K0199232J
	VW11044 SALINCAK VE DENGE KOLU BURCU SOL B22142	Yön : Sol Diğer Taraf : VW11043 Ağırlık : 0,678 kg / 1.495 lb	1K0199231G, 1K0199231H 1K0199231J
	VW11044B SALINCAK VE DENGE KOLU BURCU SOL	Yön : Sol Diğer Taraf : VW11043B Ağırlık : 0,678 kg / 1.495 lb Not : İÇ BURÇSUZ	1K0199231G, 1K0199231H 1K0199231J
	VW11047 SALINCAK VE DENGE KOLU BURCU İÇ SOL VE SAĞ B37117	Yön : İç Sol Ve Sağ Ağırlık : 0,121 kg / 0.267 lb	1K0199231J, 1K0199231J-P 1K0407183E

* Bu sayfada ve katalogdaki tüm araçların adları, markaları, modelleri, sembolleri, logoları, orjinal numaraları (oe) ve diğer üçüncü parti numaraları sadece referans amaçlı kullanılmaktadır.

CADDY
III TYP 2K
2004 - 2020

Resim	Ürün Kodu ve Açıklaması	Detay	OEM
	VW11051 SALINCAK VE DENGE KOLU BURCU SOL VE SAĞ	Yön : Sol Ve Sağ Ağırlık : 0.121 kg / 0.267 lb	6Q0407183, 6Q0407183A
	VW11055 SALINCAK VE DENGE KOLU BURCU İÇ SOL VE SAĞ	Yön : İç Sol Ve Sağ Ağırlık : 0.121 kg / 0.267 lb	1K0407183E, 8J0407183
	VW11180 Z-ROT BURCU ARKA	Şasi (Ön / Arka) : ARKA Ağırlık : 0.069 kg / 0.152 lb Uzunluk : VW4015 mm / 0.00 inch Aşık Diş Çapı : VW4015K	1K0505465C*, 1K0505465D* 1K0505465H*, 1K0505465J* 1K0505465K*
	VW12131 Z-ROT BURCU ARKA	Şasi (Ön / Arka) : ARKA Ağırlık : 0.084 kg / 0.185 lb	2K0505465B*, 2K0505465C* 2K0505465E*, 2K5505465A*
	VW12131K Z-ROT BURCU ARKA	Şasi (Ön / Arka) : ARKA Ağırlık : 0.168 kg / 0.370 lb	2K0505465B*, 2K0505465C* 2K0505465E*, 2K5505465A*
	SK12003 VİRAJ DEMİR LASTİĞİ SOL VE SAĞ RUBBER	Şasi (Ön / Arka) : ÖN Yön : Sol Ve Sağ Ağırlık : 0,075 kg / 0.165 lb Malzeme Türü : Rubber	1K0411303, 1K0411303AL* 1K0411303BK, 1K0411314 3C0411303AA*, 3C0411303T*
	SK12003K VİRAJ DEMİR LASTİĞİ SOL VE SAĞ RUBBER	Şasi (Ön / Arka) : ÖN Yön : Sol Ve Sağ Ağırlık : 0,150 kg / 0.331 lb Malzeme Türü : Rubber	1K0411303, 1K0411303AL* 1K0411303BK, 1K0411314 3C0411303AA*, 3C0411303T*
	VW12055 VİRAJ DEMİR LASTİĞİ SOL VE SAĞ RUBBER	Şasi (Ön / Arka) : ÖN Yön : Sol Ve Sağ Ağırlık : 0.1 kg / 0.220 lb Malzeme Türü : Rubber	2K0511413A, 2K0511413C 2K0511413D
	VW12140 VİRAJ DEMİR LASTİĞİ	Şasi (Ön / Arka) : ARKA Ağırlık : 0,053 kg / 0.117 lb	2K3511413
	VW12140K VİRAJ DEMİR LASTİĞİ	Şasi (Ön / Arka) : ARKA Ağırlık : 0,106 kg / 0.234 lb Not : KİT	2K3511413
	VW12017 AMORTİSÖR TAKOZU SOL VE SAĞ AMORTİSÖR TAKOZU	Yön : Sol Ve Sağ Ağırlık : 0.847 kg / 1.867 lb Not : AMORTİSÖR TAKOZU	1K0412331B, 1K0412331C

* Bu sayfada ve katalogdaki tüm araçların adları, markaları, modelleri, sembolleri, logoları, orijinal numaraları (oe) ve diğer üçüncü parti numaraları sadece referans amaçlı kullanılmaktadır.

CADDY
III TYP 2K
2004 - 2020

Resim	Ürün Kodu ve Açıklaması	Detay	OEM
	VW12109 AMORTİSÖR TAKOZU SOL VE SAĞ AMORTİSÖR RULMANI	Yön : Sol Ve Sağ Ağırlık : 0.26 kg / 0.573 lb Not : AMORTİSÖR RULMANI	6N0412249C, 6N0412249E
	VW12109K AMORTİSÖR TAKOZU SOL VE SAĞ 2 PCS	Yön : Sol Ve Sağ Ağırlık : 0.52 kg / 1.146 lb Not : 2 PCS	6N0412249C, 6N0412249E
	VW12008 MOTOR TAKOZU SOL VE SAĞ MOTOR TAKOZU	Yön : Sol Ve Sağ Ağırlık : 0.574 kg / 1.265 lb Not : MOTOR TAKOZU	357199381C, 357199402B 3A0199402
	VW12025 MOTOR TAKOZU ALT SOL VE SAĞ MOTOR TAKOZU ALT	Yön : Alt Sol Ve Sağ Ağırlık : 0.25 kg / 0.551 lb Not : MOTOR TAKOZU ALT	1K0199867A, 1K0199867B 1K0199867Q
	VW12027 MOTOR TAKOZU SOL VE SAĞ MOTOR KULAĞI	Yön : Sol Ve Sağ Ağırlık : 2.02 kg / 4.453 lb Not : MOTOR KULAĞI	1K0199262, 1K0199262CN
	VW12029 MOTOR TAKOZU SOL VE SAĞ MOTOR TAKOZU	Yön : Sol Ve Sağ Ağırlık : 0.585 kg / 1.290 lb Not : Motor takozu	1K0199855AD, 1K0199855BA 1K0199855K
	VW12032 MOTOR TAKOZU SOL VE SAĞ MOTOR TAKOZU	Yön : Sol Ve Sağ Ağırlık : 0.64 kg / 1.411 lb Not : Motor takozu	1K0199855BB, 1K0199855L
	VW12034 MOTOR TAKOZU SOL VE SAĞ MOTOR TAKOZU	Yön : Sol Ve Sağ Ağırlık : 1.9 kg / 4.189 lb Not : Motor takozu	1K0199555BA, 1K0199555BB 1K0199555L, 1K0199555M 1L0199555L
	VW12073 MOTOR TAKOZU SOL VE SAĞ MOTOR TAKOZU	Yön : Sol Ve Sağ Ağırlık : 1.643 kg / 3.622 lb Not : MOTOR TAKOZU	1K0199262AC, 1K0199262AL 1K0199262L
	VW12074 MOTOR TAKOZU SOL VE SAĞ MOTOR TAKOZU	Yön : Sol Ve Sağ Ağırlık : 1.08 kg / 2.381 lb Not : MOTOR TAKOZU	1H0199609B, 1H0199609F 1H0199609G, 1H0199609J
	VW12076 MOTOR TAKOZU SOL VE SAĞ MOTOR TAKOZU	Yön : Sol Ve Sağ Ağırlık : 1.97 kg / 4.343 lb Not : MOTOR TAKOZU	1K0199262AF, 1K0199262AT 1K0199262BB



* Bu sayfada ve katalogdaki tüm araçların adları, markaları, modelleri, sembolleri, logoları, orjinal numaraları (oe) ve diğer üçüncü parti numaraları sadece referans amaçlı kullanılmaktadır.

CADDY
III TYP 2K
2004 - 2020







Resim	Ürün Kodu ve Açıklaması	Detay	OEM
	VW12082 MOTOR TAKOZU SOL VE SAĞ MOTOR TAKOZU	Yön : Sol Ve Sağ Ağırlık : 2.05 kg / 4.519 lb Not : MOTOR TAKOZU	1K0199262AK, 1K0199262K
	VW12097 MOTOR TAKOZU SOL VE SAĞ MOTOR TAKOZU	Yön : Sol Ve Sağ Ağırlık : 0.251 kg / 0.553 lb Not : MOTOR TAKOZU	1K0199868, 1K0199868A 1K0199868C, 1K0199868P 1K0199868Q
	VW12110 MOTOR TAKOZU SOL VE SAĞ MOTOR TAKOZU	Yön : Sol Ve Sağ Ağırlık : 1.918 kg / 4.228 lb Not : MOTOR TAKOZU	1K0199262AB, 1K0199262AM 1K0199262M
	VW12124 MOTOR TAKOZU SOL VE SAĞ	Yön : Sol Ve Sağ Ağırlık : 1.927 kg / 4.248 lb	1K0199262A, 1K0199262AA 1K0199262AS
	VW12106 ŞANZIMAN TAKOZU SOL ŞANZUMAN TAKOZU SOL	Yön : Sol Ağırlık : 1.95 kg / 4.299 lb Not : ŞANZUMAN TAKOZU SOL	1K0199555AT, 1K0199555T
	VW12067 SÜSPANSİYON TAKOZU SOL VE SAĞ SÜSPANSİYON TAKOZU	Yön : Sol Ve Sağ Ağırlık : 0.065 kg / 0.143 lb Not : SÜSPANSİYON TAKOZU	1K0412303P
	VW12138 SÜSPANSİYON TAKOZU ARKA	Şasi (Ön / Arka) : ARKA Ağırlık : 0,021 kg / 0.046 lb	2K0511155, 2K0511155A 2K5511155
	VW12138K SÜSPANSİYON TAKOZU ARKA KİT	Şasi (Ön / Arka) : ARKA Ağırlık : 0,042 kg / 0.093 lb Not : KİT	2K0511155, 2K0511155A 2K5511155
	VW12086 RADYATÖR TAKOZU SOL VE SAĞ RADYATÖR ÜST LASTİĞİ	Yön : Sol Ve Sağ Ağırlık : 0.024 kg / 0.053 lb Not : RADYATÖR ÜST LASTİĞİ	1K0121367F
	VW13006 DİREKSİYON KÖRÜĞÜ	Ağırlık : 0.145 kg / 0.320 lb	1K0423831A, 5C0423831
	VW13006K DİREKSİYON KÖRÜĞÜ SOL VE SAĞ 2 PİECES	Ağırlık : 0.29 kg / 0.639 lb	1K0423831A, 5C0423831

* Bu sayfada ve katalogdaki tüm araçların adları, markaları, modelleri, sembolleri, logoları, orjinal numaraları (oe) ve diğer üçüncü parti numaraları sadece referans amaçlı kullanılmaktadır.

CADDY
III TYP 2K
2004 - 2020











Resim	Ürün Kodu ve Açıklaması	Detay	OEM
	VW14003 AKS KÖRÜĞÜ +KELEPÇE+YAĞ. DIŞ	Ağırlık : 0.25 kg / 0.551 lb	1K0 498 203, 1K0498203
	VW14011 AKS KÖRÜĞÜ +KELEPÇE+YAĞ. İÇ	Ağırlık : 0.236 kg / 0.520 lb	1K0498201D
	AU15001 AMORTİSÖR KÖRÜĞÜ ÖN	Şasi (Ön / Arka) : ÖN Ağırlık : 0,110 kg / 0.243 lb	6N0413175A

CADDY
IV TYP SB
2020 -

Resim	Ürün Kodu ve Açıklaması	Detay	OEM
	VW1042 ROTİL ALT SAĞ	Ağırlık : 0,615 kg / 1.356 lb	5R3407366
	VW1043 ROTİL ALT SOL	Ağırlık : 0,615 kg / 1.356 lb	5R3407365
	VW2033 ROTBAŞI SAĞ	Ağırlık : 0,525 kg / 1.157 lb	5WA423812E
	VW2034 ROTBAŞI SOL	Ağırlık : 0,525 kg / 1.157 lb	5WA423811E
	VW3026 ROTMİLİ ÖN	Ağırlık : 0,695 kg / 1.532 lb Uzunluk : 350 mm / 13.78 inch	5WA423810D
	VW4014 Z ROT ÖN SAĞ-SOL METAL 335 RB2935	Ağırlık : 0,46 kg / 1.014 lb Malzeme Türü : Metal Uzunluk : 335 mm / 13.19 inch Aşık Diş Çapı : M12X1,5	1K0411315B, 1K0411315D 1K0411315J, 1K0411315K 1K0411315R, 5Q0411315A 5Q0411315B
	VW4036 Z ROT ARKA PLASTİK	Ağırlık : 0,265 kg / 0.584 lb Malzeme Türü : Plastik Uzunluk : 191 mm / 7.52 inch	5R3505465C

* Bu sayfada ve katalogdaki tüm araçların adları, markaları, modelleri, sembolleri, logoları, orjinal numaraları (oe) ve diğer üçüncü parti numaraları sadece referans amaçlı kullanılmaktadır.

CADDY
IV TYP SB
2020 -







Resim	Ürün Kodu ve Açıklaması	Detay	OEM
	VW4043 Z ROT ARKA PLASTİK	Ağırlık : 0,285 kg / 0.628 lb Malzeme Türü : Plastik Uzunluk : 246 mm / 9.69 inch	5R3505465D, 5R3505465E
	VW6081 SALINCAK VE DENGE KOLU ÖN ALT SAĞ SAC LEVHA	Ağırlık : 4,190 kg / 9.237 lb Malzeme Türü : Sac Metal	5R3407152B
	VW6081J SALINCAK VE DENGE KOLU ÖN ALT SAĞ SAC LEVHA	Ağırlık : 3,595 kg / 7.926 lb Malzeme Türü : Sac Metal	5R3407152B*
	VW6082 SALINCAK VE DENGE KOLU ÖN ALT SOL SAC LEVHA	Ağırlık : 4,190 kg / 9.237 lb Malzeme Türü : Sac Metal	5R3407151B
	VW6082J SALINCAK VE DENGE KOLU ÖN ALT SOL SAC LEVHA	Ağırlık : 3,595 kg / 7.926 lb Malzeme Türü : Sac Metal	5R3407151B*
	VW9013 SALINCAK VE DENGE KOLU ARKA ALT SAĞ SAC LEVHA	Ağırlık : 1,375 kg / 3.031 lb Malzeme Türü : Sac Metal	5R3505224D
	VW9014 SALINCAK VE DENGE KOLU ARKA ALT SOL SAC LEVHA	Ağırlık : 1,375 kg / 3.031 lb Malzeme Türü : Sac Metal	5R3505223D
	VW9015 SALINCAK VE DENGE KOLU ARKA METAL	Ağırlık : 3,105 kg / 6.845 lb Malzeme Türü : Çelik Boru	5R3501529C
	VW9016 SALINCAK VE DENGE KOLU ARKA ÜST SAC LEVHA	Ağırlık : 0,580 kg / 1.279 lb Malzeme Türü : Sac Metal	5R3505237B, 5R3505237C
	VW11082 SALINCAK VE DENGE KOLU BURCU ÖN ALT İÇ	Şasi (Ön / Arka) : ÖN Yön : Alt İç Ağırlık : 0,175 kg / 0.386 lb	5Q0407182B, 5R3407151B* 5R3407152B*
	VW11083 SALINCAK VE DENGE KOLU BURCU ÖN ALT DIŞ	Şasi (Ön / Arka) : ÖN Yön : Alt Dış Ağırlık : 0,360 kg / 0.794 lb	5Q0407183N, 5R3407151B* 5R3407152B*

* Bu sayfada ve katalogdaki tüm araçların adları, markaları, modelleri, sembolleri, logoları, orjinal numaraları (oe) ve diğer üçüncü parti numaraları sadece referans amaçlı kullanılmaktadır.

CARIBE
1977 - 1987

Resim	Ürün Kodu ve Açıklaması	Detay	OEM
	VW1005 ROTİL ALT SOL VE SAĞ RD0512	Ağırlık : 0,346 kg / 0.763 lb Bağlantı Delik Çapı : Ø7,5	171407365C, 171407365D
	VW1006 ROTİL SAĞ RD0513	Ağırlık : 0,35 kg / 0.772 lb Bağlantı Delik Çapı : Ø7,5	171407365F, 171407365G
	VW2003 ROTBAŞI SAĞ-SOL RD0339	Ağırlık : 0,3 kg / 0.661 lb Uzunluk : 79 mm / 3.11 inch Gövde Diş Çapı : M14X1,5 Aşık Diş Çapı : M12X1,5 Aşık Konik Çapı : Ø12,3	171419811, 171419811A 171419812, 251419811 32111116463, 477419811 477419815, 94434733300
	VW3002 ROTMİLİ RD0811	Ağırlık : 0,665 kg / 1.466 lb Uzunluk : 342 mm / 13.46 inch Gövde Diş Çapı : M22X1,5 Aşık Diş Çapı : M14X1,5	171419821, 171419821A
	VW20033002 ROT TAKIMI SOL VE SAĞ	Ağırlık : 0,963 kg / 2.123 lb Rotbaşı : VW2003 Rotmilî : VW3002	171 419 804, 171419804
	VW6001 SALINCAK ÖN ALT SAĞ	Ağırlık : 3,652 kg / 8.051 lb Malzeme Türü : Sac Metal	171407153D
	VW6001J SALINCAK ÖN ALT	Ağırlık : 2,236 kg / 4.930 lb Malzeme Türü : Sac Metal	171407153D
	VW6002 SALINCAK ÖN ALT SOL RD1047	Ağırlık : 2,668 kg / 5.882 lb Malzeme Türü : Sac Metal	171407153D
	VW11004 SALINCAK VE DENGE KOLU BURCU SOL VE SAĞ B40112	Yön : Sol Ve Sağ Ağırlık : 0,121 kg / 0.267 lb	171407181, 171407181A
	VW11005 SALINCAK VE DENGE KOLU BURCU ORTA SOL VE SAĞ B40113	Yön : Orta Sol Ve Sağ Ağırlık : 0,087 kg / 0.192 lb	171407182D, 171407182E

CC 358 2011 - 2016

Resim	Ürün Kodu ve Açıklaması	Detay	OEM
	VW1019 ROTİL ÖN SAĞ Ø15,3 RB2538	Ağırlık : 0,555 kg / 1.224 lb Konik Ölçüsü : Ø15,3 Bağlantı Delik Çapı : Ø10,5 Aşık Diş Çapı : M12X1,5	3C0407366A
	VW1020 ROTİL ÖN SOL Ø15,3 RB2539	Ağırlık : 0,555 kg / 1.224 lb Konik Ölçüsü : Ø15,3 Bağlantı Delik Çapı : Ø10,5 Aşık Diş Çapı : M12X1,5	3C0407365A
	VW1031 ROTİL ÖN ALT SAĞ Ø15,2	Ağırlık : 0,59 kg / 1.301 lb Konik Ölçüsü : Ø15,2 Aşık Diş Çapı : M12X1,5	3C0407366B
	VW1032 ROTİL ÖN ALT SOL Ø15,2	Ağırlık : 0,59 kg / 1.301 lb Konik Ölçüsü : Ø15,2 Aşık Diş Çapı : M12X1,5	3C0407365B
	VW2008 ROTBAŞI ÖN SAĞ RD0342	Ağırlık : 0,412 kg / 0.908 lb Uzunluk : 95 mm / 3.74 inch Gövde Diş Çapı : M16X1,5 Aşık Diş Çapı : M12X1,5 Aşık Konik Çapı : Ø12,7	1K0423812A, 1K0423812C 1K0423812E, 1K0423812G 1K0423812J, 1K0423812K 1KD423812A
	VW2009 ROTBAŞI ÖN SOL RD0343	Ağırlık : 0,412 kg / 0.908 lb Uzunluk : 95 mm / 3.74 inch Gövde Diş Çapı : M16X1,5 Aşık Diş Çapı : M12X1,5 Aşık Konik Çapı : Ø13,5	1K0423811A, 1K0423811C 1K0423811E, 1K0423811G 1K0423811J, 1K0423811K 1KD423811A
	VW3009 ROTMİLİ SAĞ-SOL 310 RB2838	Ağırlık : 0,665 kg / 1.466 lb Uzunluk : 311 mm / 12.24 inch Gövde Diş Çapı : M16X1,5 Aşık Diş Çapı : M16X1,5	1K0423810A

VW8002 / Süspansiyon Kit Ön

CC

358





2011 - 2016



Kit Parçaları

Resim	Ürün Kodu / Adı	OEM	OEM	Ürün Kodu / Adı	Resim
	VW2008 Rotbaşı Ön Sağ Rd0342	1K0423812A, 1K0423812C 1K0423812E, 1K0423812G 1K0423812J, 1K0423812K 1KD423812A	1K0423811A, 1K0423811C 1K0423811E, 1K0423811G 1K0423811J, 1K0423811K 1KD423811A	VW2009 Rotbaşı Ön Sol Rd0343	
	VW3009 Rotmili Sağ-sol 310 Rb2838	1K0423810A	1K0411315B, 1K0411315D 1K0411315J, 1K0411315K 1K0411315R, 5Q0411315A 5Q0411315B	VW4014 Z Rot Ön Sağ-sol Metal 335 Rb2935	
	VW6032 Salıncak Ön Sağ Rd1051	3C0407151A, 3C0407151B 3C0407151E, 3C0407151G*	3C0407151A, 3C0407151B 3C0407151E, 3C0407151H*	VW6033 Salıncak Ön Sol Rd1052	



* Bu sayfada ve katalogdaki tüm araçların adları, markaları, modelleri, sembolleri, logoları, orjinal numaraları (oe) ve diğer üçüncü parti numaraları sadece referans amaçlı kullanılmaktadır.

CC	358		2011 - 2016
Resim	Ürün Kodu ve Açıklaması	Detay	OEM
	VW20083009 ROT TAKIMI ÖN AKS SAĞ RB288137	Ağırlık : 1,078 kg / 2.377 lb Rotbaşı : VW2008 Rotmili : VW3009	
	VW20093009 ROT TAKIMI ÖN SOL RB288138	Ağırlık : 1,077 kg / 2.374 lb Rotbaşı : VW2009 Rotmili : VW3009	
	SK4005 Z ROT ÖM SAĞ-SOL L=335MM	Ağırlık : 0,322 kg / 0.710 lb Malzeme Türü : Metal Uzunluk : 335 mm / 13.19 inch Aşık Diş Çapı : M12X1,5	5Q0411315B
	VW4015 Z ROT SOL VE SAĞ METAL RB2937	Ağırlık : 0,373 kg / 0.822 lb Malzeme Türü : Metal Uzunluk : 95,5 mm / 3.76 inch Aşık Diş Çapı : M10X1,5	1K0505465C, 1K0505465D 1K0505465H, 1K0505465J 1K0505465K
	VW4015K Z ROT SOL VE SAĞ METAL	Ağırlık : 0,373 kg / 0.822 lb Malzeme Türü : Metal Uzunluk : 95,5 mm / 3.76 inch Aşık Diş Çapı : M10X1,5	1K0505465C, 1K0505465D 1K0505465H, 1K0505465J 1K0505465K
	SE9001 SALINCAK ALT SAĞ RA5150	Ağırlık : 1 kg / 2.205 lb Malzeme Türü : Sac Metal	1K0501530C
	SE9002 SALINCAK ALT SOL RA5151	Ağırlık : 1 kg / 2.205 lb Malzeme Türü : Sac Metal	1K0501529F
	VW6032 SALINCAK ÖN SAĞ RD1051	Ağırlık : 3,441 kg / 7.586 lb Malzeme Türü : Alüminyum	3C0407151A, 3C0407151B 3C0407151E, 3C0407151G*
	VW6032J SALINCAK ÖN RD1050	Ağırlık : 2,9 kg / 6.393 lb Malzeme Türü : Alüminyum	3C0407151A, 3C0407151B 3C0407151E, 3C0407151G 3C0407151H
	VW6033 SALINCAK ÖN SOL RD1052	Ağırlık : 3,441 kg / 7.586 lb Malzeme Türü : Alüminyum	3C0407151A, 3C0407151B 3C0407151E, 3C0407151H*
	VW6051 SALINCAK ÖN SAĞ	Ağırlık : 4,34 kg / 9.568 lb Malzeme Türü : Sac Metal	5N0407152*

* Bu sayfada ve katalogdaki tüm araçların adları, markaları, modelleri, sembolleri, logoları, orijinal numaraları (oe) ve diğer üçüncü parti numaraları sadece referans amaçlı kullanılmaktadır.

CC	358		2011 - 2016
Resim	Ürün Kodu ve Açıklaması	Detay	OEM
	VW6051J SALINCAK ÖN SAĞ	Ağırlık : 3,79 kg / 8.356 lb Malzeme Türü : Sac Metal	5N0407152
	VW6052 SALINCAK ÖN SOL	Ağırlık : 4,34 kg / 9.568 lb Malzeme Türü : Sac Metal	5N0407151*
	VW6052J SALINCAK ÖN SOL	Ağırlık : 3,79 kg / 8.356 lb Malzeme Türü : Sac Metal	5N0407151
	VW6059 SALINCAK ÖN ALT SAĞ	Ağırlık : 3,490 kg / 7.694 lb Malzeme Türü : Alüminyum	3C0407152A, 3C0407152B 3C0407152E
	VW6060 SALINCAK ALT SOL	Ağırlık : 3,490 kg / 7.694 lb Malzeme Türü : Alüminyum	3C0407151A, 3C0407151B 3C0407151E
	VW6079 SALINCAK VE DENGE KOLU ÖN ALT SAĞ SAC LEVHA	Ağırlık : 3,624 kg / 7.990 lb Malzeme Türü : Sac Metal	5Q0407152T, 81A407152C 81A407152E, 81A407152F
	VW6079J SALINCAK VE DENGE KOLU ÖN ALT SAĞ SAC LEVHA	Ağırlık : 3,202 kg / 7.059 lb Malzeme Türü : Sac Metal	5Q0407154E, 5WA407151A 5WA407152A
	VW6080 SALINCAK VE DENGE KOLU ÖN ALT SOL SAC LEVHA	Ağırlık : 3,624 kg / 7.990 lb Malzeme Türü : Sac Metal	5Q0407151T, 81A407151C 81A407151E, 81A407151F
	VW6080J SALINCAK VE DENGE KOLU ÖN ALT SOL SAC LEVHA	Ağırlık : 3,202 kg / 7.059 lb Malzeme Türü : Sac Metal	5Q0407153E, 5WA407151A 5WA407152A
	AU11014 SALINCAK VE DENGE KOLU BURCU ARKA SOL VE SAĞ	Şasi (Ön / Arka) : ARKA Yön : Sol Ve Sağ Ağırlık : 0.192 kg / 0.423 lb	1K0505543A
	VW11037 SALINCAK VE DENGE KOLU BURCU SOL VE SAĞ	Yön : Sol Ve Sağ Ağırlık : 0.11 kg / 0.243 lb	1K0505279A

* Bu sayfada ve katalogdaki tüm araçların adları, markaları, modelleri, sembolleri, logoları, orjinal numaraları (oe) ve diğer üçüncü parti numaraları sadece referans amaçlı kullanılmaktadır.





CC	358		2011 - 2016
Resim	Ürün Kodu ve Açıklaması	Detay	OEM
	VW11042 SALINCAK VE DENGE KOLU BURCU ORTA SOL VE SAĞ	Yön : Orta Sol Ve Sağ Ağırlık : 0,182 kg / 0.401 lb	1K0407182, 5Q0407182
	VW11183 SALINCAK VE DENGE KOLU BURCU ÖN ALT	Şasi (Ön / Arka) : ÖN Yön : Alt Ağırlık : 0,322 kg / 0.710 lb	5Q0407182F, 5Q0407183D 5Q0407183E, 5Q0407183J 5Q0407183L
	VW11180 Z-ROT BURCU ARKA	Şasi (Ön / Arka) : ARKA Ağırlık : 0.069 kg / 0.152 lb Uzunluk : VW4015 mm / 0.00 inch Aşık Diş Çapı : VW4015K	1K0505465C*, 1K0505465D* 1K0505465H*, 1K0505465J* 1K0505465K*
	VW12159 TAŞIYICI DESTEK BURÇLARI ARKA SOL VE SAĞ	Şasi (Ön / Arka) : ARKA Yön : Sol Ve Sağ Ağırlık : 0,130 kg / 0.287 lb	1K0505553, 1K0505553A
	AU12024 TORSİYON BURCU ARKA SOL VE SAĞ	Şasi (Ön / Arka) : ARKA Yön : Sol Ve Sağ Ağırlık : 0.557 kg / 1.228 lb	1K0505145F, 1K0505145H 1K0505145K
	VW12127 TORSİYON BURCU ARKA	Şasi (Ön / Arka) : ARKA Ağırlık : 0,265 kg / 0.584 lb	3C0505145
	VW12128 TORSİYON BURCU ARKA	Şasi (Ön / Arka) : ARKA Ağırlık : 0,200 kg / 0.441 lb	3C0505145A
	SK12003 VİRAJ DEMİR LASTİĞİ SOL VE SAĞ RUBBER	Şasi (Ön / Arka) : ÖN Yön : Sol Ve Sağ Ağırlık : 0,075 kg / 0.165 lb Malzeme Türü : Rubber	1K0411303, 1K0411303AL* 1K0411303BK, 1K0411314 3C0411303AA*, 3C0411303T*
	SK12003K VİRAJ DEMİR LASTİĞİ SOL VE SAĞ RUBBER	Şasi (Ön / Arka) : ÖN Yön : Sol Ve Sağ Ağırlık : 0,150 kg / 0.331 lb Malzeme Türü : Rubber	1K0411303, 1K0411303AL* 1K0411303BK, 1K0411314 3C0411303AA*, 3C0411303T*
	VW12017 AMORTİSÖR TAKOZU SOL VE SAĞ AMORTİSÖR TAKOZU	Yön : Sol Ve Sağ Ağırlık : 0.847 kg / 1.867 lb Not : AMORTİSÖR TAKOZU	1K0412331B, 1K0412331C
	VW12109 AMORTİSÖR TAKOZU SOL VE SAĞ AMORTİSÖR RULMANI	Yön : Sol Ve Sağ Ağırlık : 0.26 kg / 0.573 lb Not : AMORTİSÖR RULMANI	6N0412249C, 6N0412249E

* Bu sayfada ve katalogdaki tüm araçların adları, markaları, modelleri, sembolleri, logoları, orijinal numaraları (oe) ve diğer üçüncü parti numaraları sadece referans amaçlı kullanılmaktadır.

CC 358 2011 - 2016











Resim	Ürün Kodu ve Açıklaması	Detay	OEM
	VW12109K AMORTİSÖR TAKOZU SOL VE SAĞ 2 PCS	Yön : Sol Ve Sağ Ağırlık : 0.52 kg / 1.146 lb Not : 2 PCS	6N0412249C, 6N0412249E
	VW12086 RADYATÖR TAKOZU SOL VE SAĞ RADYATÖR ÜST LASTİĞİ	Yön : Sol Ve Sağ Ağırlık : 0.024 kg / 0.053 lb Not : RADYATÖR ÜST LASTİĞİ	1K0121367F
	VW13006 DİREKSİYON KÖRÜĞÜ	Ağırlık : 0.145 kg / 0.320 lb	1K0423831A, 5C0423831
	VW13006K DİREKSİYON KÖRÜĞÜ SOL VE SAĞ 2 PİECES	Ağırlık : 0.29 kg / 0.639 lb	1K0423831A, 5C0423831
	VW14003 AKS KÖRÜĞÜ +KELEPÇE+YAĞ. DIŞ	Ağırlık : 0.25 kg / 0.551 lb	1K0 498 203, 1K0498203
	AU15001 AMORTİSÖR KÖRÜĞÜ ÖN	Şasi (Ön / Arka) : ÖN Ağırlık : 0,110 kg / 0.243 lb	6N0413175A

CORRADO 1983 - 1992

Resim	Ürün Kodu ve Açıklaması	Detay	OEM
	VW1011 ROTİL D= Ø17	Ağırlık : 0,39 kg / 0.860 lb Bağlantı Delik Çapı : Ø8,5	191407365, 191407365B
	VW1011K ROTİL ALT SAĞ-SOL Ø17 RD0514	Ağırlık : 0,435 kg / 0.959 lb Bağlantı Delik Çapı : Ø8,5	191.407.365F, 191407365 191407365B*, 191407365F
	VW1012 ROTİL ALT SOL VE SAĞ	Ağırlık : 0,353 kg / 0.778 lb Bağlantı Delik Çapı : Ø8,5	357407365, 357407365A
	VW1012K ROTİL ALT SAĞ-SOL 19 RD0515	Ağırlık : 0,445 kg / 0.981 lb Bağlantı Delik Çapı : Ø8,5	357407365, 357407365A* 357407365A, 357407365S 357407365-S1

* Bu sayfada ve katalogdaki tüm araçların adları, markaları, modelleri, sembolleri, logoları, orjinal numaraları (oe) ve diğer üçüncü parti numaraları sadece referans amaçlı kullanılmaktadır.

CORRADO
1983 - 1992

Resim	Ürün Kodu ve Açıklaması	Detay	OEM
	VW2006 ROTBAŞI SAĞ RD0312	Ağırlık : 0,3 kg / 0.661 lb Uzunluk : 76 mm / 2.99 inch Gövde Diş Çapı : M14X1,5 Aşık Diş Çapı : M12X1,5 Aşık Konik Çapı : Ø12,7	191419812, 22190091617 6N0419812, 6N0422812 XA2087
	VW2007 ROTBAŞI SOL RD0311	Ağırlık : 0,3 kg / 0.661 lb Uzunluk : 76 mm / 2.99 inch Gövde Diş Çapı : M14X1,5 Aşık Diş Çapı : M12X1,5 Aşık Konik Çapı : Ø12,7	191419811, 22190090617 6N0419811, 6N0422811 XA2084
	VW3003 ROTMİLİ SAĞ-SOL RD0817	Ağırlık : 0,678 kg / 1.495 lb Uzunluk : 340 mm / 13.39 inch Gövde Diş Çapı : M22X1,5 Aşık Diş Çapı : M14X1,5	191419721, 191419803 191419803-PART, 191419804* 191419804, 191419807A 191419821
	VW3004 ROTMİLİ ÖN SAĞ - SOL 338 RD0887	Ağırlık : 0,605 kg / 1.334 lb Uzunluk : 338 mm / 13.31 inch Gövde Diş Çapı : M14X1,5 Aşık Diş Çapı : M14X1,5	191407153, 191422721 191422803A, 191422804A 191422807, 191422807A 191422821, 191422821A 6K0422821
	VW20063003 ROT TAKIMI SAĞ RD088116	Ağırlık : 0,984 kg / 2.169 lb Rotbaşı : VW2006 Rotmilî : VW3003	191419804, 191419804A
	VW20063004 ROT TAKIMI ÖN AKS SAĞ	Ağırlık : 0,991 kg / 2.185 lb Rotbaşı : VW2006 Rotmilî : VW3004	191422804A
	VW20073003 ROT TAKIMI SOL RD088115	Ağırlık : 0,978 kg / 2.156 lb Rotbaşı : VW2007 Rotmilî : VW3003	191419803, 191419803A
	VW20073004 ROT TAKIMI SOL RD088118	Ağırlık : 0,991 kg / 2.185 lb Rotbaşı : VW2007 Rotmilî : VW3004	191422803, 191422803A
	VW4004 Z ROT ÖN SAĞ - SOL KOMPLE RD0942	Ağırlık : 0,189 kg / 0.417 lb Malzeme Türü : Komple Uzunluk : 75 mm / 2.95 inch	191411315, 191411315B 191411315BKIT, 191411315BS
	VW4029 Z ROT ÖN SAĞ - SOL	Ağırlık : 0,166 kg / 0.366 lb Uzunluk : 77 mm / 3.03 inch	191411315B
	VW6004 SALINCAK ÖN SAĞ	Ağırlık : 3,21 kg / 7.077 lb Malzeme Türü : Sac Metal	191407151A





* Bu sayfada ve katalogdaki tüm araçların adları, markaları, modelleri, sembolleri, logoları, orjinal numaraları (oe) ve diğer üçüncü parti numaraları sadece referans amaçlı kullanılmaktadır.

CORRADO
1983 - 1992

Resim	Ürün Kodu ve Açıklaması	Detay	OEM
	VW60046005K SALINCAK ÖN	Ağırlık : 3.8 kg / 8.378 lb Malzeme Türü : Sac Metal	
	VW6004J SALINCAK ÖN RD1103	Ağırlık : 2,605 kg / 5.743 lb Malzeme Türü : Sac Metal	191.407.151B, 191407151A 191407151B
	VW6005 SALINCAK ÖN SOL	Ağırlık : 3,21 kg / 7.077 lb Malzeme Türü : Sac Metal	192407151A
	VW6006 SALINCAK ÖN SAĞ RD1019	Ağırlık : 3,166 kg / 6.980 lb Malzeme Türü : Sac Metal	191407151B, 191407175 191411315B, 191411331 357407365A, 6N0411329 N0111849, N10127702
	VW60066007K SALINCAK ÖN	Ağırlık : 3.3 kg / 7.275 lb Malzeme Türü : Sac Metal	
	VW600674008K SALINCAK ÖN	Ağırlık : 3.466 kg / 7.641 lb Malzeme Türü : Sac Metal	
	VW6007 SALINCAK ÖN SOL RD1029	Ağırlık : 3,088 kg / 6.808 lb Malzeme Türü : Sac Metal	191407151A
	AU11005 SALINCAK VE DENGE KOLU BURCU ÖN ORTA SOL VE SAĞ B40115	Şasi (Ön / Arka) : ÖN Yön : Orta Sol Ve Sağ Ağırlık : 0,111 kg / 0.245 lb Not : VW6014 - VW60614J	191407182, 357407182 357407182F
	VW11001 SALINCAK VE DENGE KOLU BURCU SOL VE SAĞ B40114	Yön : Sol Ve Sağ Ağırlık : 0.141 kg / 0.311 lb	191407181D, 191407181E 357407181
	VW11840 BURÇ	Yön : Sol Ve Sağ Ağırlık : 0,149 kg / 0.328 lb	357407181
	VW12037 VİRAJ DEMİR LASTİĞİ SOL VE SAĞ RUBBER	Şasi (Ön / Arka) : ÖN Yön : Sol Ve Sağ Ağırlık : 0.11 kg / 0.243 lb Malzeme Türü : Rubber Not : VİRAJ DEMİR LASTİĞİ ÖN	191411314

* Bu sayfada ve katalogdaki tüm araçların adları, markaları, modelleri, sembolleri, logoları, orjinal numaraları (oe) ve diğer üçüncü parti numaraları sadece referans amaçlı kullanılmaktadır.

CORRADO
1983 - 1992









Resim	Ürün Kodu ve Açıklaması	Detay	OEM
	VW12037K VİRAJ DEMİR LASTİĞİ SOL VE SAĞ RUBBER	Şasi (Ön / Arka) : ÖN Yön : Sol Ve Sağ Ağırlık : 0.22 kg / 0.485 lb Malzeme Türü : Rubber	191411314*
	VW12111 VİRAJ DEMİR LASTİĞİ SOL VE SAĞ RUBBER	Şasi (Ön / Arka) : ÖN Yön : Sol Ve Sağ Ağırlık : 0.015 kg / 0.033 lb Malzeme Türü : Rubber Not : VİRAJ LASTİĞİ	191411329, 6N0411329
	VW12111K VİRAJ DEMİR LASTİĞİ SOL VE SAĞ RUBBER	Şasi (Ön / Arka) : ÖN Yön : Sol Ve Sağ Ağırlık : 0.03 kg / 0.066 lb Malzeme Türü : Rubber	191411329*, 6N0411329*
	VW12065 AMORTİSÖR TAKOZU SOL VE SAĞ AMORTİSÖR KEPİ	Yön : Sol Ve Sağ Ağırlık : 0.377 kg / 0.831 lb Not : AMORTİSÖR KEPİ	191 512 113, 191512113
	VW12065K AMORTİSÖR TAKOZU ÖN SOL VE SAĞ 2 PCS	Şasi (Ön / Arka) : ÖN Yön : Sol Ve Sağ Ağırlık : 0.758 kg / 1.671 lb Not : 2 PCS	191512113
	VW12088 SÜSPANSİYON TAKOZU SOL VE SAĞ SÜSPANSİYON TAKOZU ARKA	Yön : Sol Ve Sağ Ağırlık : 0.11 kg / 0.243 lb Not : SÜSPANSİYON TAKOZU ARKA	191512131B
	VW12089 SÜSPANSİYON TAKOZU SOL VE SAĞ SÜSPANSİYON TAKOZU	Yön : Sol Ve Sağ Ağırlık : 0.15 kg / 0.331 lb Not : SÜSPANSİYON TAKOZU	191412303A, 357412303E
	RN14006 AKS KÖRÜĞÜ +KELEPÇE+YAĞ. DIŞ	Ağırlık : 0.2 kg / 0.441 lb	1603180, 1603204 16410170470106*, 16500170470106* 1H0498203, 271648 271649, 321498203A 431498203C, 443498203D

CORRADO
531
1987 - 1995

Resim	Ürün Kodu ve Açıklaması	Detay	OEM
	VW1013 ROTİL ÖN ALT Ø16,5 RD0519	Ağırlık : 0,415 kg / 0.915 lb Konik Ölçüsü : Ø16,5 Bağlantı Delik Çapı : Ø8,5 Aşık Diş Çapı : M12X1,5	1H0407365
	VW1013K ROTİL	Ağırlık : 0,495 kg / 1.091 lb Konik Ölçüsü : Ø16,5 Bağlantı Delik Çapı : Ø8,5 Aşık Diş Çapı : M12X1,5	1H0407365*, 1H0407365









* Bu sayfada ve katalogdaki tüm araçların adları, markaları, modelleri, sembolleri, logoları, orjinal numaraları (oe) ve diğer üçüncü parti numaraları sadece referans amaçlı kullanılmaktadır.

CORRADO
531
1987 - 1995

Resim	Ürün Kodu ve Açıklaması	Detay	OEM
	VW2006 ROTBAŞI SAĞ RD0312	Ağırlık : 0,3 kg / 0.661 lb Uzunluk : 76 mm / 2.99 inch Gövde Diş Çapı : M14X1,5 Aşık Diş Çapı : M12X1,5 Aşık Konik Çapı : Ø12,7	191419812, 22190091617 6N0419812, 6N0422812 XA2087
	VW2007 ROTBAŞI SOL RD0311	Ağırlık : 0,3 kg / 0.661 lb Uzunluk : 76 mm / 2.99 inch Gövde Diş Çapı : M14X1,5 Aşık Diş Çapı : M12X1,5 Aşık Konik Çapı : Ø12,7	191419811, 22190090617 6N0419811, 6N0422811 XA2084
	VW3003 ROTMİLİ SAĞ-SOL RD0817	Ağırlık : 0,678 kg / 1.495 lb Uzunluk : 340 mm / 13.39 inch Gövde Diş Çapı : M22X1,5 Aşık Diş Çapı : M14X1,5	191419721, 191419803 191419803-PART, 191419804* 191419804, 191419807A 191419821
	VW3004 ROTMİLİ ÖN SAĞ - SOL 338 RD0887	Ağırlık : 0,605 kg / 1.334 lb Uzunluk : 338 mm / 13.31 inch Gövde Diş Çapı : M14X1,5 Aşık Diş Çapı : M14X1,5	191407153, 191422721 191422803A, 191422804A 191422807, 191422807A 191422821, 191422821A 6K0422821
	VW3008 ROTMİLİ SAĞ-SOL 371 RD0826	Ağırlık : 0,652 kg / 1.437 lb Uzunluk : 371 mm / 14.61 inch Gövde Diş Çapı : M14X1,5 Aşık Diş Çapı : M14X1,5	1H0422803, 1H0422804 1H0422821, 803419811
	VW20063004 ROT TAKIMI ÖN AKS SAĞ	Ağırlık : 0,991 kg / 2.185 lb Rotbaşı : VW2006 Rotmilî : VW3004	191422804A
	VW20073004 ROT TAKIMI SOL RD088118	Ağırlık : 0,991 kg / 2.185 lb Rotbaşı : VW2007 Rotmilî : VW3004	191422803, 191422803A
	VW6014 SALINCAK ÖN SAĞ RD1021	Ağırlık : 3,966 kg / 8.744 lb Malzeme Türü : Sac Metal	1H0407152*
	VW6014J SALINCAK ÖN SAĞ RD1106	Ağırlık : 3,35 kg / 7.385 lb Malzeme Türü : Sac Metal	1H0407152
	VW6015 SALINCAK ÖN SOL RD1022	Ağırlık : 3,674 kg / 8.100 lb Malzeme Türü : Sac Metal	1H0407151A *, 1H0407151A*
	VW6015J SALINCAK ÖN SOL RD1105	Ağırlık : 3,152 kg / 6.949 lb Malzeme Türü : Sac Metal	1H0.407.151A, 1H0407151 1H0407151A

* Bu sayfada ve katalogdaki tüm araçların adları, markaları, modelleri, sembolleri, logoları, orjinal numaraları (oe) ve diğer üçüncü parti numaraları sadece referans amaçlı kullanılmaktadır.

CORRADO
531
1987 - 1995





Resim	Ürün Kodu ve Açıklaması	Detay	OEM
	VW12012 BEŞİK (TRAVERS) BURCU ARKA SOL VE SAĞ	Şasi (Ön / Arka) : ARKA Yön : Sol Ve Sağ Ağırlık : 0,63 kg / 1.389 lb	1H0501541A
	VW12012K BEŞİK (TRAVERS) BURCU ARKA SOL VE SAĞ	Şasi (Ön / Arka) : ARKA Yön : Sol Ve Sağ Ağırlık : 1,260 kg / 2.778 lb	1H0501541A
	VW12013 BEŞİK (TRAVERS) BURCU ARKA SOL VE SAĞ	Şasi (Ön / Arka) : ARKA Yön : Sol Ve Sağ Ağırlık : 1,380 kg / 3.042 lb	1H0501541A
	VW12005 AMORTİSÖR TAKOZU SOL VE SAĞ AMORTİSÖR ÜST TAKOZU	Yön : Sol Ve Sağ Ağırlık : 0.1 kg / 0.220 lb Not : AMORTİSÖR ÜST TAKOZU	191512333
	VW12058 AMORTİSÖR TAKOZU SOL VE SAĞ	Yön : Sol Ve Sağ Ağırlık : 0.654 kg / 1.442 lb	357412329
	VW13008 DİREKSİYON KÖRÜĞÜ	Ağırlık : 0.225 kg / 0.496 lb	1H0422831B
	VW13010 DİREKSİYON KÖRÜĞÜ ÖN	Ağırlık : 0,124 kg / 0.273 lb	191422831
	OP14003 AKS KÖRÜĞÜ +KELEPÇE+YAĞ. AKS KÖRÜĞÜ DIŞ	Ağırlık : 0.2 kg / 0.441 lb	1603180

CORSAR
1984 - 1989



Resim	Ürün Kodu ve Açıklaması	Detay	OEM
	AU1002 ROTİL ÖN SAĞ - SOL RB2512	Ağırlık : 0,46 kg / 1.014 lb Bağlantı Delik Çapı : Ø10,5	321413025B, 321413026B 823407365E
	AU2311 ROTBAŞI ÖN SAĞ - SOL RB2311	Ağırlık : 0,218 kg / 0.481 lb Uzunluk : 75 mm / 2.95 inch Gövde Diş Çapı : M14X1,5 Aşık Diş Çapı : M10X1 Aşık Konik Çapı : Ø11	811419812A, 811419812B 8A0419812

* Bu sayfada ve katalogdaki tüm araçların adları, markaları, modelleri, sembolleri, logoları, orjinal numaraları (oe) ve diğer üçüncü parti numaraları sadece referans amaçlı kullanılmaktadır.

CORSAR
1984 - 1989

Resim	Ürün Kodu ve Açıklaması	Detay	OEM
	AU6001 SALINCAK ÖN	Ağırlık : 2,31 kg / 5.093 lb Malzeme Türü : Sac Metal	3074071551C*, 811407147B* 893407147G*
	AU6001J SALINCAK ÖN RB3102	Ağırlık : 1,866 kg / 4.114 lb Malzeme Türü : Sac Metal	3074071551C, 811407147B 893407147G
	AU11046 SALINCAK VE DENGE KOLU BURCU SOL VE SAĞ	Yön : Sol Ve Sağ Ağırlık : 0,118 kg / 0.260 lb	811407181, 811407181A
	AU11046K SALINCAK VE DENGE KOLU BURCU SOL VE SAĞ	Yön : Sol Ve Sağ Ağırlık : 0,236 kg / 0.520 lb	811407181, 811407181A
	AU12008 VİRAJ DEMİR LASTİĞİ SOL VE SAĞ RUBBER	Şasi (Ön / Arka) : ÖN Yön : Sol Ve Sağ Ağırlık : 0,03 kg / 0.066 lb Malzeme Türü : Rubber	823411313A*, 823411313A
	AU12008K VİRAJ DEMİR LASTİĞİ SOL VE SAĞ RUBBER	Şasi (Ön / Arka) : ÖN Yön : Sol Ve Sağ Ağırlık : 0.06 kg / 0.132 lb Malzeme Türü : Rubber	823411313A*

CRAFTER
2E, 2F
2006 - 2016

Resim	Ürün Kodu ve Açıklaması	Detay	OEM
	ME1018 ROTİL ÖN SAĞ - SOL Ø22 RC0428	Ağırlık : 0,675 kg / 1.488 lb Konik Ölçüsü : Ø22 Aşık Dış Çapı : M20X1,5 Rotil Gövde Çapı : Ø45,2	9063304007-P
	ME2035 ROTBAŞI ÖN SAĞ - SOL RC0346	Ağırlık : 0,572 kg / 1.261 lb Uzunluk : 90 mm / 3.54 inch Gövde Dış Çapı : M16X1,5 Aşık Dış Çapı : M14X1,5 Aşık Konik Çapı : Ø17	2E0498104, 2E0498104A 2E0713501, 90610481001 90610481003, 9064600048 9064600148, 9064600348 A9064600148
	ME3011 ROTMİLİ SAĞ-SOL 396 RC0826	Ağırlık : 0,88 kg / 1.940 lb Uzunluk : 394 mm / 15.51 inch Gövde Dış Çapı : M18X1,5 Aşık Dış Çapı : M16X1,5	2E0713491, 9064600055 A9064600055

* Bu sayfada ve katalogdaki tüm araçların adları, markaları, modelleri, sembolleri, logoları, orjinal numaraları (oe) ve diğer üçüncü parti numaraları sadece referans amaçlı kullanılmaktadır.

ME8006 / Süspansiyon Kit Ön

CRAFTER

2E, 2F



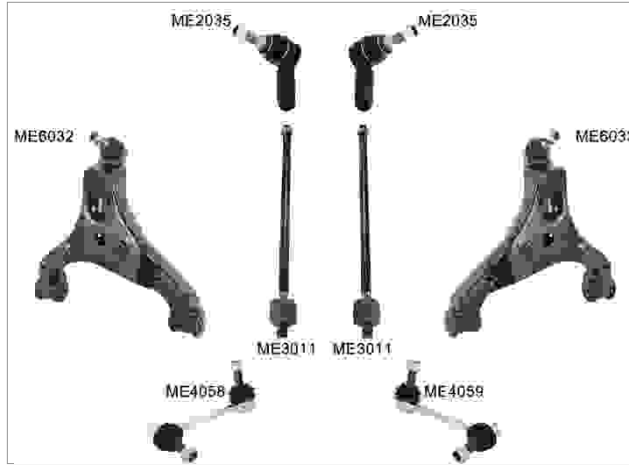







2006 - 2016



Kit Parçaları









Resim	Ürün Kodu / Adı	OEM	OEM	Ürün Kodu / Adı	Resim
	ME2035 Rotbaşı Ön Sağ - Sol Rc0346	2E0498104, 2E0498104A 2E0713501, 90610481001 90610481003, 9064600048 9064600148, 9064600348 A9064600148	2E0713491, 9064600055 A9064600055	ME3011 Rotmili Sağ-sol 396 Rc0826	
	ME4058 Z Rot Ön Sağ Metal Rc0993	2E0411318C, 9063201889	2E0411317C, 9063201789	ME4059 Z Rot Ön Sol Metal Rc0994	
	ME6032 Salıncak Ön Alt Sağ Rc1054	2E0407152M, 9063304107	2E0407151M, 9063304007	ME6033 Salıncak Ön Alt Sol Rc1055	

CRAFTER
2E, 2F
2006 - 2016

Resim	Ürün Kodu ve Açıklaması	Detay	OEM
	ME20353011 ROT TAKIMI ÖN AKS	Ağırlık : 1,452 kg / 3.201 lb Rotbaşı : ME2035 Rotmili : ME3011	
	ME4025 Z ROT ARKA METAL	Ağırlık : 0,6 kg / 1.323 lb Malzeme Türü : Metal Uzunluk : 140 mm / 5.51 inch	2E0511051G, 9063201489
	ME4058 Z ROT ÖN SAĞ METAL RC0993	Ağırlık : 0,352 kg / 0.776 lb Malzeme Türü : Metal Uzunluk : 137,5 mm / 5.41 inch Aşık Diş Çapı : M12X1,5	2E0411318C, 9063201889
	ME4059 Z ROT ÖN SOL METAL RC0994	Ağırlık : 0,352 kg / 0.776 lb Malzeme Türü : Metal Uzunluk : 137,5 mm / 5.41 inch Aşık Diş Çapı : M12X1,5	2E0411317C, 9063201789
	VW4026 Z ROT L=300	Ağırlık : 0.56 kg / 1.235 lb Uzunluk : 300 mm / 11.81 inch	9013200689
	VW4027 Z ROT L=213/230/245	Ağırlık : 0,372 kg / 0.820 lb Uzunluk : 213 mm / 8.39 inch	2E0511051F, 68013817AA 9063201389
	ME6032 SALINCAK ÖN ALT SAĞ RC1054	Ağırlık : 8,198 kg / 18.073 lb Malzeme Türü : Sac Metal	2E0407152M, 9063304107
	ME6033 SALINCAK ÖN ALT SOL RC1055	Ağırlık : 8,198 kg / 18.073 lb Malzeme Türü : Sac Metal	2E0407151M, 9063304007
	ME11063 SALINCAK VE DENGE KOLU BURCU SOL VE SAĞ B30195	Yön : Sol Ve Sağ Ağırlık : 0,387 kg / 0.853 lb	2E0407523, 68012169AA 68012176AA, 9063330014 A9063330014, SS7120
	ME12005 VİRAJ DEMİR LASTİĞİ SOL VE SAĞ RUBBER	Şasi (Ön / Arka) : ÖN Yön : Sol Ve Sağ Ağırlık : 0.102 kg / 0.225 lb Malzeme Türü : Rubber Not : VİRAJ LASTİĞİ	2D0511413B, 5118800AA 9043260881, A9043260881
	ME12005K VİRAJ DEMİR LASTİĞİ SOL VE SAĞ RUBBER	Şasi (Ön / Arka) : ÖN Yön : Sol Ve Sağ Ağırlık : 0.204 kg / 0.450 lb Malzeme Türü : Rubber	2D0511413B*, 5118800AA* 9043260881*, A9043260881*

* Bu sayfada ve katalogdaki tüm araçların adları, markaları, modelleri, sembolleri, logoları, orjinal numaraları (oe) ve diğer üçüncü parti numaraları sadece referans amaçlı kullanılmaktadır.

CRAFTER
2E, 2F
2006 - 2016











Resim	Ürün Kodu ve Açıklaması	Detay	OEM
	VW12043 VİRAJ DEMİR LASTİĞİ SOL VE SAĞ RUBBER	Şasi (Ön / Arka) : ÖN Yön : Sol Ve Sağ Ağırlık : 1.2 kg / 2.646 lb Malzeme Türü : Rubber Not : VİRAJ LASTİĞİ	2E0411041C, 9063231485 9063233585
	VW12043K VİRAJ DEMİR LASTİĞİ SOL VE SAĞ RUBBER	Şasi (Ön / Arka) : ÖN Yön : Sol Ve Sağ Ağırlık : 2.4 kg / 5.291 lb Malzeme Türü : Rubber Not : VİRAJ LASTİĞİ (İKİLİ)	2E0411041C*, 2E0411041C 9063231485*, 9063233585*
	VW12120 AMORTİSÖR TAKOZU ÖN SOL VE SAĞ AMORTİSÖR TAKOZU	Şasi (Ön / Arka) : ÖN Yön : Sol Ve Sağ Ağırlık : 0.6 kg / 1.323 lb Malzeme Türü : Amortisör TakoZu	2E0407181C, 2E0407181D 68013708AA, 9063230520 A9063230520
	VW12120K AMORTİSÖR TAKOZU ÖN SOL VE SAĞ	Şasi (Ön / Arka) : ÖN Yön : Sol Ve Sağ Ağırlık : 1.2 kg / 2.646 lb	2E0407181C, 2E0407181D 68013708AA, 9063230520 A9063230520
	ME12100 MOTOR TAKOZU ÖN SAĞ	Şasi (Ön / Arka) : ÖN Yön : Sağ Ağırlık : 1,720 kg / 3.792 lb	68005193AA, 9062411113 9062411613, A9012411013 A9062411113, A9062411213 A9062411613
	ME12049 ŞAFT TAKOZU SOL VE SAĞ ŞAFT ASKI TAKOZU	Yön : Sol Ve Sağ Ağırlık : 1.018 kg / 2.244 lb Malzeme Türü : Şaft Askı TakoZu İç Çap : 47,0	2E0598351B, 5154107282 9064100281, 9064100281SK 9064100681, 9064100881 9064101181, 9064101381 9064101681, 9064101881
	ME12140 ŞAFT TAKOZU	Ağırlık : 1,055 kg / 2.326 lb	2E0598351C, 9064100101 9064100181, 9064100381 A9064100101, A9064100181 A9064100381
	ME15001 AMORTİSÖR KÖRÜĞÜ ÖN	Şasi (Ön / Arka) : ÖN Ağırlık : 0,115 kg / 0.254 lb	2E0413175A, 2E0413175B 68013709AA, 9063230192 9063230292, A9063230192 A9063230292

CRAFTER
SY, SZ
2016 -

Resim	Ürün Kodu ve Açıklaması	Detay	OEM
	VW1041 ROTİL ALT	Ağırlık : 0,597 kg / 1.316 lb	2N0407361A
	VW2029 ROTBAŞI SAĞ	Ağırlık : 1.25 kg / 2.756 lb Uzunluk : 203 mm / 7.99 inch Gövde Diş Çapı : M20X1,5 Aşık Diş Çapı : M14X1,5 Aşık Konik Çapı : Ø22,1	2N0423812



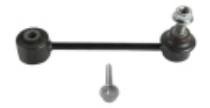





* Bu sayfada ve katalogdaki tüm araçların adları, markaları, modelleri, sembolleri, logoları, orijinal numaraları (oe) ve diğer üçüncü parti numaraları sadece referans amaçlı kullanılmaktadır.

CRAFTER
SY, SZ
2016 -

Resim	Ürün Kodu ve Açıklaması	Detay	OEM
	VW2030 ROTBAŞI SOL	Ağırlık : 1.25 kg / 2.756 lb Uzunluk : 203 mm / 7.99 inch Gövde Diş Çapı : M20X1,5 Aşık Diş Çapı : M14X1,5 Aşık Konik Çapı : Ø22,1	2N0423811
	VW3024 ROTMİLİ SOL VE SAĞ	Ağırlık : 0,731 kg / 1.612 lb	2N0423810, 65.46710-0000 65467100000
	VW20293024 ROT TAKIMI SAĞ	Ağırlık : 1.981 kg / 4.367 lb Rotbaşı : VW2029 Rotmilî : VW3024	
	VW20303024 ROT TAKIMI SOL	Ağırlık : 1.981 kg / 4.367 lb Rotbaşı : VW2030 Rotmilî : VW3024	
	VW4032 Z ROT SAĞ METAL	Ağırlık : 0,960 kg / 2.116 lb Malzeme Türü : Metal Uzunluk : 379 mm / 14.92 inch	2N0411317B, 2N0411317C 2N0411317D, 65.46710-0002
	VW4033 Z ROT SOL METAL	Ağırlık : 0,960 kg / 2.116 lb Malzeme Türü : Metal Uzunluk : 379 mm / 14.92 inch	2N0411318, 2N0411318A 2N0411318B, 65.46710-0001
	VW4034 Z ROT SOL VE SAĞ	Ağırlık : 0.58 kg / 1.279 lb	2N0505465A
	VW4037 Z ROT ARKA METAL	Ağırlık : 0,510 kg / 1.124 lb Malzeme Türü : Metal Uzunluk : 224 mm / 8.82 inch	2N050546B, 65437180005
	VW4038 Z ROT ARKA METAL	Ağırlık : 0,475 kg / 1.047 lb Malzeme Türü : Metal Uzunluk : 224 mm / 8.82 inch	2N0505465, 65437180004
	VW4038K Z ROT ARKA METAL	Ağırlık : 0,575 kg / 1.268 lb Malzeme Türü : Metal Uzunluk : 224 mm / 8.82 inch	2N0505465, 65437180004
	VW6071 SALINCAK ALT SAĞ	Ağırlık : 7,810 kg / 17.218 lb Malzeme Türü : Sac Metal	2N0407152G, 2N0407152J 2N0407152M, 65433156008 65433156015











* Bu sayfada ve katalogdaki tüm araçların adları, markaları, modelleri, sembolleri, logoları, orjinal numaraları (oe) ve diğer üçüncü parti numaraları sadece referans amaçlı kullanılmaktadır.

CRAFTER
SY, SZ
2016 -

Resim	Ürün Kodu ve Açıklaması	Detay	OEM
	VW6072 SALINCAK ALT SOL	Ağırlık : 7,810 kg / 17.218 lb Malzeme Türü : Sac Metal	2N0407151G, 2N0407151J 2N0407151M, 65433156007 65433156017
	VW6073 SALINCAK ALT SAĞ	Ağırlık : 7,830 kg / 17.262 lb Malzeme Türü : Sac Metal	2N0407152F, 2N0407152H 65433156012
	VW6074 SALINCAK ALT SOL	Ağırlık : 7,830 kg / 17.262 lb Malzeme Türü : Sac Metal	2N0407151F, 2N0407151H 65433156009
	VW11077 SALINCAK VE DENGE KOLU BURCU ÖN ALT SOL VE SAĞ	Şasi (Ön / Arka) : ÖN Yön : Alt Sol Ve Sağ Ağırlık : 0.23 kg / 0.507 lb	2N0407183A, 65433160005
	VW11080 SALINCAK VE DENGE KOLU BURCU ÖN ALT	Şasi (Ön / Arka) : ÖN Yön : Alt Ağırlık : 0,305 kg / 0.672 lb	2N0407151J*, 2N0407152J*
	VW11081 SALINCAK VE DENGE KOLU BURCU ÖN ALT	Şasi (Ön / Arka) : ÖN Yön : Alt Ağırlık : 0,315 kg / 0.694 lb	2N0407151F*, 2N0407152F*
	VW11078 Z-ROT BURCU ARKA ARKA	Şasi (Ön / Arka) : ARKA Yön : Arka Ağırlık : 0.12 kg / 0.265 lb Uzunluk : VW4034 mm / 0.00 inch	2N0505465A*
	VW11079 Z-ROT BURCU ARKA ARKA	Şasi (Ön / Arka) : ARKA Yön : Arka Ağırlık : 0.11 kg / 0.243 lb	2N0505465B*
	VW12125 YAY BURCU ARKA ALT SOL VE SAĞ	Şasi (Ön / Arka) : ARKA Yön : Alt Sol Ve Sağ	2N0511414
	VW12126 YAY BURCU ARKA ALT SOL VE SAĞ	Şasi (Ön / Arka) : ARKA Yön : Alt Sol Ve Sağ	2N0511413





* Bu sayfada ve katalogdaki tüm araçların adları, markaları, modelleri, sembolleri, logoları, orjinal numaraları (oe) ve diğer üçüncü parti numaraları sadece referans amaçlı kullanılmaktadır.

CROSSFOX
2007 - 2015

Resim	Ürün Kodu ve Açıklaması	Detay	OEM
	SK1025 ROTİL SAĞ	Ağırlık : 0,59 kg / 1.301 lb Konik Ölçüsü : Ø15 Bağlantı Delik Çapı : Ø10,5 Aşık Diş Çapı : M12X1,5	5U0407366A, 6R0407366 6R0407366A, 6R0407366B
	SK1026 ROTİL ÖN ALT SOL Ø15	Ağırlık : 0,59 kg / 1.301 lb Konik Ölçüsü : Ø15 Bağlantı Delik Çapı : Ø10,5 Aşık Diş Çapı : M12X1,5	5U0407365A, 6R0407365 6R0407365A, 6R0407365B
	SK2003 ROTBAŞI SAĞ RC7314	Ağırlık : 0,377 kg / 0.831 lb Uzunluk : 93,5 mm / 3.68 inch Gövde Diş Çapı : M14X1,5 Aşık Diş Çapı : M12X1,5 Aşık Konik Çapı : Ø13,5	5Z0423812, 6Q0419812C 6Q0423812, 6Q0423812A 6Q0423812C, 6Q0423812D 6R0423812, 8Z0423811A
	SK2004 ROTBAŞI SOL RC7313	Ağırlık : 0,382 kg / 0.842 lb Uzunluk : 93 mm / 3.66 inch Gövde Diş Çapı : M14X1,5 Aşık Diş Çapı : M12X1,5 Aşık Konik Çapı : Ø13,5	5Z0423811, 6Q0419811C 6Q0423811, 6Q0423811A 6Q0423811C, 6Q0423811D 6R0423811, 8Z0423812A
	SK3003 ROTMİLİ SAĞ-SOL 297	Ağırlık : 0,552 kg / 1.217 lb Uzunluk : 297 mm / 11.69 inch Gövde Diş Çapı : M14X1,5 Aşık Diş Çapı : M14X1,5	6Q0 423 821 B, 6Q0423821B 6X0422803, 6X0422804 6X0422807, 6X0422821
	SK3004 ROTMİLİ SAĞ-SOL 300 RC7817	Ağırlık : 0,536 kg / 1.182 lb Uzunluk : 300 mm / 11.81 inch Gövde Diş Çapı : M16X1,5 Aşık Diş Çapı : M14X1,5	6Q0423803A, 6Q0423804A 6Q0-423-810-C, 6Q0423821A 6Q0423821C, 6Q0423821G
	VW3018 ROTMİLİ ÖN SAĞ-SOL	Ağırlık : 0,552 kg / 1.217 lb Uzunluk : 297 mm / 11.69 inch Gövde Diş Çapı : M14X1,5 Aşık Diş Çapı : M14X1,5	6X0422803, 6X0422804 6X0422807, 6X0422821
	SK20033003 ROT TAKIMI ÖN AKS SAĞ RC788115	Ağırlık : 1,021 kg / 2.251 lb Rotbaşı : SK2003 Rotmilî : SK3003	6Q0422804B, 6Q0423804B
	SK20043003 ROT TAKIMI SOL RC788114	Ağırlık : 0,932 kg / 2.055 lb Rotbaşı : SK2004 Rotmilî : SK3003	6Q0422803B, 6Q0423803B
	AU4028 Z ROT ÖN	Ağırlık : 0,368 kg / 0.811 lb Malzeme Türü : Metal Uzunluk : 270 mm / 10.63 inch Aşık Diş Çapı : M10X1,5	6Q0411315L, 6Q0411315N 8Z0411315D
	SK6009J SALINCAK ÖN ALT RD10211	Ağırlık : 2,626 kg / 5.789 lb Malzeme Türü : Sac Metal	6Q0407151D, 6Q0407151E 6Q0407151L

* Bu sayfada ve katalogdaki tüm araçların adları, markaları, modelleri, sembolleri, logoları, orjinal numaraları (oe) ve diğer üçüncü parti numaraları sadece referans amaçlı kullanılmaktadır.

CROSSFOX
2007 - 2015

Resim	Ürün Kodu ve Açıklaması	Detay	OEM
	VW11045 SALINCAK VE DENGİ KOLU BURCU ORTA SOL VE SAĐ B40128	Yön : Orta Sol Ve Sağ Ağırlık : 0,145 kg / 0.320 lb	6Q0407182A
	VW11047 SALINCAK VE DENGİ KOLU BURCU İÇ SOL VE SAĐ B37117	Yön : İç Sol Ve Sağ Ağırlık : 0,121 kg / 0.267 lb	1K0199231J, 1K0199231J-P 1K0407183E
	VW11055 SALINCAK VE DENGİ KOLU BURCU İÇ SOL VE SAĐ	Yön : İç Sol Ve Sağ Ağırlık : 0.121 kg / 0.267 lb	1K0407183E, 8J0407183
	VW12010 TORSİYON BURCU SOL VE SAĐ	Yön : Sol Ve Sağ Ağırlık : 0.31 kg / 0.683 lb	1J0500045, 1J0500045A 1J0501541B, 1J0501541C 6R0501541A, 6R0501541B
	SE12005 MOTOR TAKOZU ARKA	Şasi (Ön / Arka) : ARKA Ağırlık : 1,115 kg / 2.458 lb	6Q0199851AS, 6Q0199851T

DASHER
1978 - 1981

Resim	Ürün Kodu ve Açıklaması	Detay	OEM
	AU1002 ROTİL ÖN SAĐ - SOL RB2512	Ağırlık : 0,46 kg / 1.014 lb Bağlantı Delik Çapı : Ø10,5	321413025B, 321413026B 823407365E
	AU2213 ROTBAŞI ÖN SAĐ - SOL RB2213	Ağırlık : 0,315 kg / 0.694 lb Uzunluk : 100 mm / 3.94 inch Gövde Diş Çapı : M14X1,5 Aşık Diş Çapı : M10X1 Aşık Konik Çapı : Ø10,6	321419811, 811419812 823419811, 861419802 861419812

DERBY
1974 - 1994



Resim	Ürün Kodu ve Açıklaması	Detay	OEM
	AU2213 ROTBAŞI ÖN SAĐ - SOL RB2213	Ağırlık : 0,315 kg / 0.694 lb Uzunluk : 100 mm / 3.94 inch Gövde Diş Çapı : M14X1,5 Aşık Diş Çapı : M10X1 Aşık Konik Çapı : Ø10,6	321419811, 811419812 823419811, 861419802 861419812
	VW5001 SALINCAK ÖN	Ağırlık : 1,336 kg / 2.945 lb Malzeme Türü : Dövme Çelik	861407151A

* Bu sayfada ve katalogdaki tüm araçların adları, markaları, modelleri, sembolleri, logoları, orjinal numaraları (oe) ve diğer üçüncü parti numaraları sadece referans amaçlı kullanılmaktadır.

DERBY
I
1974 - 1994

Resim	Ürün Kodu ve Açıklaması	Detay	OEM
	VW5002 SALINCAK ÖN	Ağırlık : 1,370 kg / 3.020 lb Malzeme Türü : Dövme Çelik	861407151B
	VW7004 ARA ROT ÖN AKS	Şasi (Ön / Arka) : ÖN Yön : Sol Ve Sağ Ağırlık : 1.22 kg / 2.690 lb Rotbaşı 1 : VW11028	871419802
	VW7005 ARA ROT ARKA AKS SAĞ BUSH = VW11028	Şasi (Ön / Arka) : ÖN Yön : Sağ Diğer Taraf : VW7006 Ağırlık : 1,167 kg / 2.573 lb Uzunluk : 515 mm / 20.28 inch	871419801A
	VW7006 ARA ROT ARKA AKS SOL BUSH = VW11028	Şasi (Ön / Arka) : ÖN Yön : Sol Diğer Taraf : VW7005 Ağırlık : 1,161 kg / 2.560 lb Uzunluk : 515 mm / 20.28 inch	872419802A
	VW11003 SALINCAK VE DENGE KOLU BURCU SOL VE SAĞ B22129	Yön : Sol Ve Sağ Ağırlık : 0,126 kg / 0.278 lb	823407181, 861407181
	VW11027 SALINCAK VE DENGE KOLU BURCU ORTA SOL VE SAĞ B40126	Yön : Orta Sol Ve Sağ Ağırlık : 0,082 kg / 0.181 lb	861407183
	VW11028 SALINCAK VE DENGE KOLU BURCU ORTA SOL VE SAĞ	Yön : Orta Sol Ve Sağ Ağırlık : 0,056 kg / 0.123 lb	
	AU12012 EGSOZ TAKOZU ÖN SOL VE SAĞ EGSOZ LASTİĞİ	Şasi (Ön / Arka) : ÖN Yön : Sol Ve Sağ Ağırlık : 0.034 kg / 0.075 lb Not : EGSOZ LASTİĞİ	191253147B, 4A0253147A

DERBY
II
1994 - 2009

Resim	Ürün Kodu ve Açıklaması	Detay	OEM
	VW1012 ROTİL ALT SOL VE SAĞ	Ağırlık : 0,353 kg / 0.778 lb Bağlantı Delik Çapı : Ø8,5	357407365, 357407365A
	VW1012K ROTİL ALT SAĞ-SOL 19 RD0515	Ağırlık : 0,445 kg / 0.981 lb Bağlantı Delik Çapı : Ø8,5	357407365, 357407365A* 357407365A, 357407365S 357407365-S1





* Bu sayfada ve katalogdaki tüm araçların adları, markaları, modelleri, sembolleri, logoları, orjinal numaraları (oe) ve diğer üçüncü parti numaraları sadece referans amaçlı kullanılmaktadır.

DERBY
II
1994 - 2009





Resim	Ürün Kodu ve Açıklaması	Detay	OEM
	VW2006 ROTBAŞI SAĞ RD0312	Ağırlık : 0,3 kg / 0.661 lb Uzunluk : 76 mm / 2.99 inch Gövde Diş Çapı : M14X1,5 Aşık Diş Çapı : M12X1,5 Aşık Konik Çapı : Ø12,7	191419812, 22190091617 6N0419812, 6N0422812 XA2087
	VW2007 ROTBAŞI SOL RD0311	Ağırlık : 0,3 kg / 0.661 lb Uzunluk : 76 mm / 2.99 inch Gövde Diş Çapı : M14X1,5 Aşık Diş Çapı : M12X1,5 Aşık Konik Çapı : Ø12,7	191419811, 22190090617 6N0419811, 6N0422811 XA2084
	VW2022 ROTBAŞI SAĞ RD0336	Ağırlık : 0,357 kg / 0.787 lb Uzunluk : 93,5 mm / 3.68 inch Gövde Diş Çapı : M14X1,5 Aşık Diş Çapı : M12X1,5 Aşık Konik Çapı : Ø12,6	6E0419812, 6K0422812 6X0422812, 8Z0419812A
	VW2023 ROTBAŞI SOL RD0335	Ağırlık : 0,354 kg / 0.780 lb Uzunluk : 93,5 mm / 3.68 inch Gövde Diş Çapı : M14X1,5 Aşık Diş Çapı : M12X1,5 Aşık Konik Çapı : Ø12,6	6E0419811, 6K0422811 6X0422811, 8Z0419811A
	VW3004 ROTMİLİ ÖN SAĞ - SOL 338 RD0887	Ağırlık : 0,605 kg / 1.334 lb Uzunluk : 338 mm / 13.31 inch Gövde Diş Çapı : M14X1,5 Aşık Diş Çapı : M14X1,5	191407153, 191422721 191422803A, 191422804A 191422807, 191422807A 191422821, 191422821A 6K0422821
	VW4023 Z ROT ÖN SAĞ - SOL	Ağırlık : 0,195 kg / 0.430 lb Uzunluk : 78 mm / 3.07 inch Aşık Diş Çapı : M12X1,5	191411315A, 191411327
	VW6004J SALINCAK ÖN RD1103	Ağırlık : 2,605 kg / 5.743 lb Malzeme Türü : Sac Metal	191.407.151B, 191407151A 191407151B
	VW6006 SALINCAK ÖN SAĞ RD1019	Ağırlık : 3,166 kg / 6.980 lb Malzeme Türü : Sac Metal	191407151B, 191407175 191411315B, 191411331 357407365A, 6N0411329 N0111849, N10127702
	VW6007 SALINCAK ÖN SOL RD1029	Ağırlık : 3,088 kg / 6.808 lb Malzeme Türü : Sac Metal	191407151A
	AU11005 SALINCAK VE DENGE KOLU BURCU ÖN ORTA SOL VE SAĞ B40115	Şasi (Ön / Arka) : ÖN Yön : Orta Sol Ve Sağ Ağırlık : 0,111 kg / 0.245 lb Not : VW6014 - VW60614J	191407182, 357407182 357407182F
	VW11001 SALINCAK VE DENGE KOLU BURCU SOL VE SAĞ B40114	Yön : Sol Ve Sağ Ağırlık : 0.141 kg / 0.311 lb	191407181D, 191407181E 357407181

* Bu sayfada ve katalogdaki tüm araçların adları, markaları, modelleri, sembolleri, logoları, orjinal numaraları (oe) ve diğer üçüncü parti numaraları sadece referans amaçlı kullanılmaktadır.











DERBY
II
1994 - 2009

Resim	Ürün Kodu ve Açıklaması	Detay	OEM
	VW12060 TORSİYON BURCU SOL VE SAĞ	Yön : Sol Ve Sağ Ağırlık : 0,459 kg / 1.012 lb	191501541
	VW12068 TORSİYON BURCU ARKA SOL VE SAĞ	Şasi (Ön / Arka) : ARKA Yön : Sol Ve Sağ Ağırlık : 0.166 kg / 0.366 lb	6N0501541, 6N0501541D
	VW12068K TORSİYON BURCU ARKA SOL VE SAĞ	Şasi (Ön / Arka) : ARKA Yön : Sol Ve Sağ Ağırlık : 0.332 kg / 0.732 lb	6N0501541, 6N0501541D
	VW12061 AMORTİSÖR TAKOZU SOL VE SAĞ AMORTİSÖR TAKOZU	Yön : Sol Ve Sağ Ağırlık : 0.27 kg / 0.595 lb Not : AMORTİSÖR TAKOZU	1H0412365A, 1J0412249 1J0412331BS, 1J0412331C
	VW12061K AMORTİSÖR TAKOZU SOL VE SAĞ 2 PCS	Yön : Sol Ve Sağ Ağırlık : 0.7 kg / 1.543 lb Not : 2 PCS	1H0412365A, 1J0412249 1J0412331BS, 1J0412331C

EOS
1F7, 1F8
2006 - 2016

Resim	Ürün Kodu ve Açıklaması	Detay	OEM
	VW1014 ROTİL ÖN ALT SAĞ Ø15,6 RB2536	Ağırlık : 0,565 kg / 1.246 lb Konik Ölçüsü : Ø15,6 Bağlantı Delik Çapı : Ø10,5 Aşık Diş Çapı : M12X1,5	1K0407366B, 1K0407366C 1K0407366E, 5Q0407366A
	VW1015 ROTİL ÖN ALT SOL Ø15,6 RB2537	Ağırlık : 0,565 kg / 1.246 lb Konik Ölçüsü : Ø15,6 Bağlantı Delik Çapı : Ø10,5 Aşık Diş Çapı : M12X1,5	1K0407365B, 1K0407365C 1K0407365E, 5Q0407365A
	VW2008 ROTBAŞI ÖN SAĞ RD0342	Ağırlık : 0,412 kg / 0.908 lb Uzunluk : 95 mm / 3.74 inch Gövde Diş Çapı : M16X1,5 Aşık Diş Çapı : M12X1,5 Aşık Konik Çapı : Ø12,7	1K0423812A, 1K0423812C 1K0423812E, 1K0423812G 1K0423812J, 1K0423812K 1KD423812A
	VW2009 ROTBAŞI ÖN SOL RD0343	Ağırlık : 0,412 kg / 0.908 lb Uzunluk : 95 mm / 3.74 inch Gövde Diş Çapı : M16X1,5 Aşık Diş Çapı : M12X1,5 Aşık Konik Çapı : Ø13,5	1K0423811A, 1K0423811C 1K0423811E, 1K0423811G 1K0423811J, 1K0423811K 1KD423811A
	VW3009 ROTMİLİ SAĞ-SOL 310 RB2838	Ağırlık : 0,665 kg / 1.466 lb Uzunluk : 311 mm / 12.24 inch Gövde Diş Çapı : M16X1,5 Aşık Diş Çapı : M16X1,5	1K0423810A

* Bu sayfada ve katalogdaki tüm araçların adları, markaları, modelleri, sembolleri, logoları, orjinal numaraları (oe) ve diğer üçüncü parti numaraları sadece referans amaçlı kullanılmaktadır.

EOS	1F7, 1F8	2006 - 2016	
Resim	Ürün Kodu ve Açıklaması	Detay	OEM
	VW20083009 ROT TAKIMI ÖN AKS SAĞ RB288137	Ağırlık : 1,078 kg / 2.377 lb Rotbaşı : VW2008 Rotmilii : VW3009	
	VW20093009 ROT TAKIMI ÖN SOL RB288138	Ağırlık : 1,077 kg / 2.374 lb Rotbaşı : VW2009 Rotmilii : VW3009	
	SK4005 Z ROT ÖM SAĞ-SOL L=335MM	Ağırlık : 0,322 kg / 0.710 lb Malzeme Türü : Metal Uzunluk : 335 mm / 13.19 inch Aşık Diş Çapı : M12X1,5	5Q0411315B
	VW4014 Z ROT ÖN SAĞ-SOL METAL 335 RB2935	Ağırlık : 0,46 kg / 1.014 lb Malzeme Türü : Metal Uzunluk : 335 mm / 13.19 inch Aşık Diş Çapı : M12X1,5	1K0411315B, 1K0411315D 1K0411315J, 1K0411315K 1K0411315R, 5Q0411315A 5Q0411315B
	VW4015 Z ROT SOL VE SAĞ METAL RB2937	Ağırlık : 0,373 kg / 0.822 lb Malzeme Türü : Metal Uzunluk : 95,5 mm / 3.76 inch Aşık Diş Çapı : M10X1,5	1K0505465C, 1K0505465D 1K0505465H, 1K0505465J 1K0505465K
	VW4015K Z ROT SOL VE SAĞ METAL	Ağırlık : 0,373 kg / 0.822 lb Malzeme Türü : Metal Uzunluk : 95,5 mm / 3.76 inch Aşık Diş Çapı : M10X1,5	1K0505465C, 1K0505465D 1K0505465H, 1K0505465J 1K0505465K
	AU6010 SALINCAK ÜST SOL VE SAĞ RA5155	Ağırlık : 1,298 kg / 2.862 lb Malzeme Türü : Sac Metal	1K0505323H, 1K0505323N
	VW6016 SALINCAK ÖN SAĞ RD10227	Ağırlık : 4,543 kg / 10.016 lb Malzeme Türü : Sac Metal	1K0407152P, 1K0407152Q* 1K0407152Q
	VW6016J SALINCAK ÖN ALT SAĞ S737	Ağırlık : 4,015 kg / 8.852 lb Malzeme Türü : Sac Metal	1K0407151P, 1K0407151Q 1K0407152P, 1K0407152Q
	VW6017 SALINCAK ÖN SOL RD10226	Ağırlık : 4,543 kg / 10.016 lb Malzeme Türü : Sac Metal	1K0407151M*, 1K0407151P 1K0407151Q*, 1K0407151Q
	VW6017J SALINCAK ÖN ALT SOL S738	Ağırlık : 4,015 kg / 8.852 lb Malzeme Türü : Sac Metal	1K0407151P, 1K0407151Q 1K0407152P, 1K0407152Q

* Bu sayfada ve katalogdaki tüm araçların adları, markaları, modelleri, sembolleri, logoları, orjinal numaraları (oe) ve diğer üçüncü parti numaraları sadece referans amaçlı kullanılmaktadır.

EOS	1F7, 1F8	2006 - 2016	
Resim	Ürün Kodu ve Açıklaması	Detay	OEM
	AU11014 SALINCAK VE DENGE KOLU BURCU ARKA SOL VE SAĞ	Şasi (Ön / Arka) : ARKA Yön : Sol Ve Sağ Ağırlık : 0.192 kg / 0.423 lb	1K0505543A
	AU11052 SALINCAK VE DENGE KOLU BURCU SOL VE SAĞ	Yön : Sol Ve Sağ Ağırlık : 0,178 kg / 0.392 lb	1K0505541B, 1K0505541C 1K0505541D
	AU11088 SALINCAK VE DENGE KOLU BURCU ARKA	Şasi (Ön / Arka) : ARKA Ağırlık : 0,165 kg / 0.364 lb	1K0505541C, 1K0505541D 3C0505541
	VW11037 SALINCAK VE DENGE KOLU BURCU SOL VE SAĞ	Yön : Sol Ve Sağ Ağırlık : 0.11 kg / 0.243 lb	1K0505279A
	VW11042 SALINCAK VE DENGE KOLU BURCU ORTA SOL VE SAĞ	Yön : Orta Sol Ve Sağ Ağırlık : 0,182 kg / 0.401 lb	1K0407182, 5Q0407182
	VW11043 SALINCAK VE DENGE KOLU BURCU SAĞ B22141	Yön : Sağ Diğer Taraf : VW11044 Ağırlık : 0,659 kg / 1.453 lb	1K0199232G, 1K0199232H 1K0199232J
	VW11043B SALINCAK VE DENGE KOLU BURCU SAĞ	Yön : Sağ Diğer Taraf : VW11044B Ağırlık : 0,659 kg / 1.453 lb Not : İÇ BURÇSUZ	1K0199232G, 1K0199232H 1K0199232J
	VW11044 SALINCAK VE DENGE KOLU BURCU SOL B22142	Yön : Sol Diğer Taraf : VW11043 Ağırlık : 0,678 kg / 1.495 lb	1K0199231G, 1K0199231H 1K0199231J
	VW11044B SALINCAK VE DENGE KOLU BURCU SOL	Yön : Sol Diğer Taraf : VW11043B Ağırlık : 0,678 kg / 1.495 lb Not : İÇ BURÇSUZ	1K0199231G, 1K0199231H 1K0199231J
	VW11051 SALINCAK VE DENGE KOLU BURCU SOL VE SAĞ	Yön : Sol Ve Sağ Ağırlık : 0.121 kg / 0.267 lb	6Q0407183, 6Q0407183A
	VW11180 Z-ROT BURCU ARKA	Şasi (Ön / Arka) : ARKA Ağırlık : 0.069 kg / 0.152 lb Uzunluk : VW4015 mm / 0.00 inch Aşık Dış Çapı : VW4015K	1K0505465C*, 1K0505465D* 1K0505465H*, 1K0505465J* 1K0505465K*

* Bu sayfada ve katalogdaki tüm araçların adları, markaları, modelleri, sembolleri, logoları, orjinal numaraları (oe) ve diğer üçüncü parti numaraları sadece referans amaçlı kullanılmaktadır.

EOS	1F7, 1F8	2006 - 2016	
Resim	Ürün Kodu ve Açıklaması	Detay	OEM
	VW12159 TAŞIYICI DESTEK BURÇLARI ARKA SOL VE SAĞ	Şasi (Ön / Arka) : ARKA Yön : Sol Ve Sağ Ağırlık : 0,130 kg / 0.287 lb	1K0505553, 1K0505553A
	SK12003 VİRAJ DEMİR LASTİĞİ SOL VE SAĞ RUBBER	Şasi (Ön / Arka) : ÖN Yön : Sol Ve Sağ Ağırlık : 0,075 kg / 0.165 lb Malzeme Türü : Rubber	1K0411303, 1K0411303AL* 1K0411303BK, 1K0411314 3C0411303AA*, 3C0411303T*
	SK12003K VİRAJ DEMİR LASTİĞİ SOL VE SAĞ RUBBER	Şasi (Ön / Arka) : ÖN Yön : Sol Ve Sağ Ağırlık : 0,150 kg / 0.331 lb Malzeme Türü : Rubber	1K0411303, 1K0411303AL* 1K0411303BK, 1K0411314 3C0411303AA*, 3C0411303T*
	VW12137 VİRAJ DEMİR LASTİĞİ	Şasi (Ön / Arka) : ARKA Ağırlık : 0,070 kg / 0.154 lb Not : Ø17mm	1K0511327AQ
	VW12137K VİRAJ DEMİR LASTİĞİ	Şasi (Ön / Arka) : ARKA Ağırlık : 0,140 kg / 0.309 lb Not : KIT	1K0511327AQ
	VW12017 AMORTİSÖR TAKOZU SOL VE SAĞ AMORTİSÖR TAKOZU	Yön : Sol Ve Sağ Ağırlık : 0.847 kg / 1.867 lb Not : AMORTİSÖR TAKOZU	1K0412331B, 1K0412331C
	VW12109 AMORTİSÖR TAKOZU SOL VE SAĞ AMORTİSÖR RULMANI	Yön : Sol Ve Sağ Ağırlık : 0.26 kg / 0.573 lb Not : AMORTİSÖR RULMANI	6N0412249C, 6N0412249E
	VW12109K AMORTİSÖR TAKOZU SOL VE SAĞ 2 PCS	Yön : Sol Ve Sağ Ağırlık : 0.52 kg / 1.146 lb Not : 2 PCS	6N0412249C, 6N0412249E
	VW12025 MOTOR TAKOZU ALT SOL VE SAĞ MOTOR TAKOZU ALT	Yön : Alt Sol Ve Sağ Ağırlık : 0.25 kg / 0.551 lb Not : MOTOR TAKOZU ALT	1K0199867A, 1K0199867B 1K0199867Q
	VW12029 MOTOR TAKOZU SOL VE SAĞ MOTOR TAKOZU	Yön : Sol Ve Sağ Ağırlık : 0.585 kg / 1.290 lb Not : Motor takozu	1K0199855AD, 1K0199855BA 1K0199855K
	VW12076 MOTOR TAKOZU SOL VE SAĞ MOTOR TAKOZU	Yön : Sol Ve Sağ Ağırlık : 1.97 kg / 4.343 lb Not : MOTOR TAKOZU	1K0199262AF, 1K0199262AT 1K0199262BB

* Bu sayfada ve katalogdaki tüm araçların adları, markaları, modelleri, sembolleri, logoları, orjinal numaraları (oe) ve diğer üçüncü parti numaraları sadece referans amaçlı kullanılmaktadır.

EOS	1F7, 1F8	2006 - 2016	
Resim	Ürün Kodu ve Açıklaması	Detay	OEM
	VW12078 MOTOR TAKOZU SOL VE SAĞ ŞANZUMAN TAKOZU	Yön : Sol Ve Sağ Ağırlık : 1.78 kg / 3.924 lb Not : ŞANZUMAN TAKOZU	1K0199555AC
	VW12082 MOTOR TAKOZU SOL VE SAĞ MOTOR TAKOZU	Yön : Sol Ve Sağ Ağırlık : 2.05 kg / 4.519 lb Not : MOTOR TAKOZU	1K0199262AK, 1K0199262K
	VW12097 MOTOR TAKOZU SOL VE SAĞ MOTOR TAKOZU	Yön : Sol Ve Sağ Ağırlık : 0.251 kg / 0.553 lb Not : MOTOR TAKOZU	1K0199868, 1K0199868A 1K0199868C, 1K0199868P 1K0199868Q
	VW12110 MOTOR TAKOZU SOL VE SAĞ MOTOR TAKOZU	Yön : Sol Ve Sağ Ağırlık : 1.918 kg / 4.228 lb Not : MOTOR TAKOZU	1K0199262AB, 1K0199262AM 1K0199262M
	VW12051 SÜSPANSİYON TAKOZU SOL VE SAĞ LASTİK DAYANAK SÜSPANSİYON	Yön : Sol Ve Sağ Ağırlık : 0.045 kg / 0.099 lb Not : LASTİK DAYANAK SÜSPANSİYON	1K0412303B
	VW12086 RADYATÖR TAKOZU SOL VE SAĞ RADYATÖR ÜST LASTİĞİ	Yön : Sol Ve Sağ Ağırlık : 0.024 kg / 0.053 lb Not : RADYATÖR ÜST LASTİĞİ	1K0121367F
	VW13006 DİREKSİYON KÖRÜĞÜ	Ağırlık : 0.145 kg / 0.320 lb	1K0423831A, 5C0423831
	VW13006K DİREKSİYON KÖRÜĞÜ SOL VE SAĞ 2 PİECES	Ağırlık : 0.29 kg / 0.639 lb	1K0423831A, 5C0423831
	VW14003 AKS KÖRÜĞÜ +KELEPÇE+YAĞ. DIŞ	Ağırlık : 0.25 kg / 0.551 lb	1K0 498 203, 1K0498203
	AU15001 AMORTİSÖR KÖRÜĞÜ ÖN	Şasi (Ön / Arka) : ÖN Ağırlık : 0,110 kg / 0.243 lb	6N0413175A
	VW15002 AMORTİSÖR KÖRÜĞÜ ARKA	Şasi (Ön / Arka) : ARKA	900064











* Bu sayfada ve katalogdaki tüm araçların adları, markaları, modelleri, sembolleri, logoları, orjinal numaraları (oe) ve diğer üçüncü parti numaraları sadece referans amaçlı kullanılmaktadır.

EUROVAN
T4
1990 - 2003

Resim	Ürün Kodu ve Açıklaması	Detay	OEM
	VW1021 ROTİL ÜST SAĞ-SOL RD0418	Ağırlık : 0,545 kg / 1.202 lb Konik Ölçüsü : Ø17,9 Aşık Diş Çapı : M16X1,5 Rotil Gövde Çapı : Ø45,5	701407187, 701407187A 701407187B
	VW1022 ROTİL ALT SAĞ-SOL RD0517	Ağırlık : 0,676 kg / 1.490 lb Konik Ölçüsü : Ø20,3 Aşık Diş Çapı : M16X1,5	701407361, 701407361B
	VW1023 ROTİL ALT SAĞ-SOL RD0521	Ağırlık : 0,615 kg / 1.356 lb Konik Ölçüsü : Ø20,4 Aşık Diş Çapı : M16X1,5	700407361, 701407361C 7D0407361, 7D0407361C
	VW2010 ROTBAŞI SAĞ RD0313	Ağırlık : 0,39 kg / 0.860 lb Uzunluk : 87 mm / 3.43 inch Gövde Diş Çapı : M16X1,5 Aşık Diş Çapı : M12X1,5 Aşık Konik Çapı : Ø12,8	701419812
	VW2011 ROTBAŞI SOL RD0314	Ağırlık : 0,391 kg / 0.862 lb Uzunluk : 92 mm / 3.62 inch Gövde Diş Çapı : M16X1,5 Aşık Diş Çapı : M12X1,5 Aşık Konik Çapı : Ø14,8	701419811A
	VW2012 ROTBAŞI SAĞ RD0315	Ağırlık : 0,454 kg / 1.001 lb Uzunluk : 92 mm / 3.62 inch Gövde Diş Çapı : M16X1,5 Aşık Diş Çapı : M12X1,5 Aşık Konik Çapı : Ø14,8	701419812A
	VW2013 ROTBAŞI SOL RD0316	Ağırlık : 0,408 kg / 0.899 lb Uzunluk : 92 mm / 3.62 inch Gövde Diş Çapı : M16X1,5 Aşık Diş Çapı : M12X1,5 Aşık Konik Çapı : Ø14,8	701419811B
	VW2014 ROTBAŞI SAĞ	Ağırlık : 0,464 kg / 1.023 lb Uzunluk : 85,5 mm / 3.37 inch Gövde Diş Çapı : M16X1,5 Aşık Diş Çapı : M12X1,5 Aşık Konik Çapı : Ø14,8	701419812B, 701419812C 701419812D
	VW2015 ROTBAŞI SOL	Ağırlık : 0,415 kg / 0.915 lb Uzunluk : 85,5 mm / 3.37 inch Gövde Diş Çapı : M16X1,5 Aşık Diş Çapı : M12X1,5 Aşık Konik Çapı : Ø14,8	701419811C, 701419811E
	VW3011 ROTMİLİ SAĞ-SOL LASTİKSİZ 295 RD0836	Ağırlık : 0,65 kg / 1.433 lb Uzunluk : 294 mm / 11.57 inch Gövde Diş Çapı : M14X1,5 Aşık Diş Çapı : M16X1,5	701419803, 701419810 701419821A, 702419821A
	VW3012 ROTMİLİ SAĞ-SOL 295 RD0835	Ağırlık : 0,647 kg / 1.426 lb Uzunluk : 294 mm / 11.57 inch Gövde Diş Çapı : M14X1,5 Aşık Diş Çapı : M16X1,5	701419803C, 701419803CY 701419804F, 701419810A 701419810B, 701419821 701419821C, 702419803D 702419821A, 702419821B

* Bu sayfada ve katalogdaki tüm araçların adları, markaları, modelleri, sembolleri, logoları, orjinal numaraları (oe) ve diğer üçüncü parti numaraları sadece referans amaçlı kullanılmaktadır.

EUROVAN
T4
1990 - 2003

Resim	Ürün Kodu ve Açıklaması	Detay	OEM
	VW20103011 ROT TAKIMI ÖN AKS SAĞ RD088173	Ağırlık : 1,047 kg / 2.308 lb Rotbaşı : VW2010 Rotmili : VW3011	7022419804A, 702419804A
	VW20103012 ROT TAKIMI ÖN AKS SAĞ RD088134	Ağırlık : 1,044 kg / 2.302 lb Rotbaşı : VW2010 Rotmili : VW3012	701419804A, 701419804C
	VW20113011 ROT TAKIMI ÖN AKS SOL RD088133	Ağırlık : 1,047 kg / 2.308 lb Rotbaşı : VW2011 Rotmili : VW3011	701419803A, 701419803C 702419803A
	VW20113012 ROT TAKIMI ÖN AKS SOL RD088174	Ağırlık : 1,038 kg / 2.288 lb Rotbaşı : VW2011 Rotmili : VW3012	701419803A, 702419803A
	VW20123011 ROT TAKIMI ÖN AKS SAĞ RD088138	Ağırlık : 1.157 kg / 2.551 lb Rotbaşı : VW2012 Rotmili : VW3011	701419804D
	VW20123012 ROT TAKIMI ÖN AKS SAĞ RD088176	Ağırlık : 1,054 kg / 2.324 lb Rotbaşı : VW2012 Rotmili : VW3012	701419804B, 702419804C
	VW20133011 ROT TAKIMI ÖN AKS SOL RD088137	Ağırlık : 1.157 kg / 2.551 lb Rotbaşı : VW2013 Rotmili : VW3011	701419803D
	VW20133012 ROT TAKIMI ÖN AKS SOL RD088175	Ağırlık : 1,053 kg / 2.321 lb Rotbaşı : VW2013 Rotmili : VW3012	701419803B, 702419803C
	VW20143011 ROT TAKIMI ÖN AKS SAĞ RD088171	Ağırlık : 1,157 kg / 2.551 lb Rotbaşı : VW2014 Rotmili : VW3011	701419804E
	VW20143012 ROT TAKIMI ÖN AKS SAĞ RD088178	Ağırlık : 1,157 kg / 2.551 lb Rotbaşı : VW2014 Rotmili : VW3012	701419804C, 702419804C
	VW20153011 ROT TAKIMI ÖN AKS SOL RD088172	Ağırlık : 1,064 kg / 2.346 lb Rotbaşı : VW2015 Rotmili : VW3011	701419803E, 701419804E

* Bu sayfada ve katalogdaki tüm araçların adları, markaları, modelleri, sembolleri, logoları, orjinal numaraları (oe) ve diğer üçüncü parti numaraları sadece referans amaçlı kullanılmaktadır.

EUROVAN
T4
1990 - 2003

Resim	Ürün Kodu ve Açıklaması	Detay	OEM
	VW20153012 ROT TAKIMI ÖN AKS SOL RD088177	Ağırlık : 1,063 kg / 2.344 lb Rotbaşı : VW2015 Rotmili : VW3012	701419803C, 702419803C
	VW4017 Z ROT SOL VE SAĞ METAL RD0920	Ağırlık : 0,31 kg / 0.683 lb Malzeme Türü : Metal Uzunluk : 109 mm / 4.29 inch	701411049, 7D0411049
	VW4018 Z ROT ÖN SAĞ-SOL METAL 108 RD0928	Ağırlık : 0,416 kg / 0.917 lb Malzeme Türü : Metal Uzunluk : 108 mm / 4.25 inch Aşık Diş Çapı : M12X1,5	701411049B
	VW6010 SALINCAK ÖN ALT SAĞ	Ağırlık : 7.609 kg / 16.775 lb Malzeme Türü : Döküm Çelik	7D0407152A
	VW6011 SALINCAK ÖN ALT SOL	Ağırlık : 7.609 kg / 16.775 lb Malzeme Türü : Döküm Çelik	7D0407151A
	VW6030 SALINCAK ÖN ALT SOL	Ağırlık : 6,674 kg / 14.714 lb Malzeme Türü : Döküm Çelik	701407151A, 701407151C 701407152A
	VW6031 SALINCAK ÖN ALT SAĞ	Ağırlık : 6,674 kg / 14.714 lb Malzeme Türü : Döküm Çelik	701407151A, 701407152A 701407152C
	VW11019 SALINCAK VE DENGE KOLU BURCU SOL VE SAĞ B405829	Yön : Sol Ve Sağ Ağırlık : 0,135 kg / 0.298 lb	701407140, 701407140C 7D0407140
	VW11019Y SALINCAK VE DENGE KOLU BURCU SOL VE SAĞ	Yön : Sol Ve Sağ Ağırlık : 0.135 kg / 0.298 lb Not : YARIKLI	701407140, 701407140B 701407140C, 7D0407140 7D0407140A
	VW11025 SALINCAK VE DENGE KOLU BURCU ORTA SOL VE SAĞ B405834	Yön : Orta Sol Ve Sağ Ağırlık : 0,192 kg / 0.423 lb	701407183C, 7D0407183
	VW11031 SALINCAK VE DENGE KOLU BURCU ORTA SOL VE SAĞ	Yön : Orta Sol Ve Sağ Ağırlık : 0,141 kg / 0.311 lb	701407077, 701407077A

* Bu sayfada ve katalogdaki tüm araçların adları, markaları, modelleri, sembolleri, logoları, orjinal numaraları (oe) ve diğer üçüncü parti numaraları sadece referans amaçlı kullanılmaktadır.

EUROVAN
T4
1990 - 2003







Resim	Ürün Kodu ve Açıklaması	Detay	OEM
	VW11040 SALINCAK VE DENGE KOLU BURCU SOL VE SAĞ	Yön : Sol Ve Sağ Ağırlık : 0,191 kg / 0.421 lb	701501131
	AU11023 Z-ROT BURCU ARKA	Şasi (Ön / Arka) : ARKA Ağırlık : 0.26 kg / 0.573 lb Uzunluk : AU4021 mm / 0.00 inch Aşık Diş Çapı : VW4017	1J0505466B*
	VW12113 Z-ROT BURCU ÖN SOL VE SAĞ RUBBER	Şasi (Ön / Arka) : ÖN Yön : Sol Ve Sağ Ağırlık : 0.023 kg / 0.051 lb Malzeme Türü : Rubber	7D0411045
	VW12113K Z-ROT BURCU ÖN SOL VE SAĞ RUBBER	Şasi (Ön / Arka) : ÖN Yön : Sol Ve Sağ Ağırlık : 0.046 kg / 0.101 lb Malzeme Türü : Rubber	7D0411045*
	VW12132 Z-ROT BURCU ÖN	Şasi (Ön / Arka) : ÖN	701411049B*
	VW12132K Z-ROT BURCU ÖN	Şasi (Ön / Arka) : ÖN	701411049B*
	VW12133 ROTMİLİ BURCU VE LASTİĞİ ÖN	Şasi (Ön / Arka) : ÖN	701419804C*, 701419804D* 701419804E*, 701419804F* 701419810A*, 701419810B* 702419803A*, 702419803B* 702419803C*, 702419803D*
	VW12133K ROTMİLİ BURCU VE LASTİĞİ ÖN	Şasi (Ön / Arka) : ÖN	701419804C*, 701419804D* 701419804E*, 701419804F* 701419810A*, 701419810B* 702419803A*, 702419803B* 702419803C*, 702419803D*
	VW12059 VİRAJ DEMİR LASTİĞİ SOL VE SAĞ RUBBER	Şasi (Ön / Arka) : ÖN Yön : Sol Ve Sağ Ağırlık : 0,025 kg / 0.055 lb Malzeme Türü : Rubber	701411041
	VW12059K VİRAJ DEMİR LASTİĞİ SOL VE SAĞ RUBBER	Şasi (Ön / Arka) : ÖN Yön : Sol Ve Sağ Ağırlık : 0.05 kg / 0.110 lb Malzeme Türü : Rubber	701407077*, 701407077A*
	VW12035 MOTOR TAKOĞU SOL VE SAĞ MOTOR TAKOĞU YAĞLI	Yön : Sol Ve Sağ Ağırlık : 1.704 kg / 3.757 lb Not : MOTOR TAKOĞU YAĞLI	701199132C, 7D0199132C 7D0199132D, 7D0199132E

* Bu sayfada ve katalogdaki tüm araçların adları, markaları, modelleri, sembolleri, logoları, orjinal numaraları (oe) ve diğer üçüncü parti numaraları sadece referans amaçlı kullanılmaktadır.

EUROVAN
T4
1990 - 2003

Resim	Ürün Kodu ve Açıklaması	Detay	OEM
	VW12114 MOTOR TAKOZU SOL VE SAĞ ŞANZUMAN BURCU	Yön : Sol Ve Sağ Ağırlık : 0.47 kg / 1.036 lb Not : ŞANZUMAN BURCU	701399207B part of, 701399207B*
	VW13003 DİREKSİYON KÖRÜĞÜ	Ağırlık : 0.115 kg / 0.254 lb	7D0419831
	VW14005 AKS KÖRÜĞÜ +KELEPÇE+YAĞ. İÇ	Ağırlık : 0.21 kg / 0.463 lb	701498201

FOX
2003 - 2022

Resim	Ürün Kodu ve Açıklaması	Detay	OEM
	SK1023 ROTİL SAĞ RD0530	Ağırlık : 0,46 kg / 1.014 lb Konik Ölçüsü : Ø15 Bağlantı Delik Çapı : Ø8,5 Aşık Dış Çapı : M12X1,5	6Q0407366A, 6Q0407366B 6Q0407366E, 6Q0407366M 8Z0407366A
	SK1023K ROTİL ÖN ALT SAĞ Ø15 KIT	Ağırlık : 0,5 kg / 1.102 lb Konik Ölçüsü : Ø15 Bağlantı Delik Çapı : Ø8,5 Aşık Dış Çapı : M12X1,5	6Q0407366A*, 6Q0407366A 6Q0407366B*, 6Q0407366E* 6Q0407366M*, 6Q0407366M 8Z0407366A*
	SK1024 ROTİL SOL RD0531	Ağırlık : 0,46 kg / 1.014 lb Konik Ölçüsü : Ø15 Bağlantı Delik Çapı : Ø8,5 Aşık Dış Çapı : M12X1,5	6Q0407365A, 6Q0407365B 6Q0407365E, 6Q0407365M 8Z0407365A
	SK1024K ROTİL SOL	Ağırlık : 0,5 kg / 1.102 lb Konik Ölçüsü : Ø15 Bağlantı Delik Çapı : Ø8,5 Aşık Dış Çapı : M12X1,5	6Q0407365A*, 6Q0407365A 6Q0407365B*, 6Q0407365E* 6Q0407365E, 6Q0407365M* 6Q0407365M, 8Z0407365A*
	SK2003 ROTBAŞI SAĞ RC7314	Ağırlık : 0,377 kg / 0.831 lb Uzunluk : 93,5 mm / 3.68 inch Gövde Dış Çapı : M14X1,5 Aşık Dış Çapı : M12X1,5 Aşık Konik Çapı : Ø13,5	5Z0423812, 6Q0419812C 6Q0423812, 6Q0423812A 6Q0423812C, 6Q0423812D 6R0423812, 8Z0423811A
	SK2004 ROTBAŞI SOL RC7313	Ağırlık : 0,382 kg / 0.842 lb Uzunluk : 93 mm / 3.66 inch Gövde Dış Çapı : M14X1,5 Aşık Dış Çapı : M12X1,5 Aşık Konik Çapı : Ø13,5	5Z0423811, 6Q0419811C 6Q0423811, 6Q0423811A 6Q0423811C, 6Q0423811D 6R0423811, 8Z0423812A
	SK3004 ROTMİLİ SAĞ-SOL 300 RC7817	Ağırlık : 0,536 kg / 1.182 lb Uzunluk : 300 mm / 11.81 inch Gövde Dış Çapı : M16X1,5 Aşık Dış Çapı : M14X1,5	6Q0423803A, 6Q0423804A 6Q0-423-810-C, 6Q0423821A 6Q0423821C, 6Q0423821G

* Bu sayfada ve katalogdaki tüm araçların adları, markaları, modelleri, sembolleri, logoları, orjinal numaraları (oe) ve diğer üçüncü parti numaraları sadece referans amaçlı kullanılmaktadır.





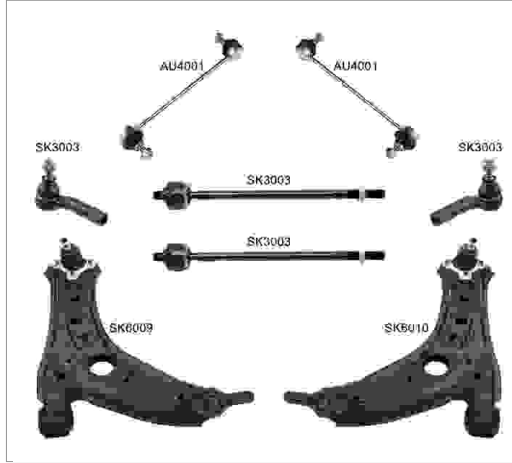





FOX**2003 - 2022**

Resim	Ürün Kodu ve Açıklaması	Detay	OEM
	SK3007 ROTMİLİ SAĞ-SOL	Ağırlık : 0,561 kg / 1.237 lb Uzunluk : 311 mm / 12.24 inch Gövde Diş Çapı : M14X1,5 Aşık Diş Çapı : M14X1,5	6Q0419803B, 6Q0419803D 6Q0419803F, 6Q0419804B 6Q0419804D, 6Q0419804F

SK8001 / Süspansiyon Kit
FOX
2003 - 2022

Kit Parçaları

Resim	Ürün Kodu / Adı	OEM	OEM	Ürün Kodu / Adı	Resim
	AU4001 Z Rot Sol Ve Sağ Metal Rb2911	893407465, 893407465A 8A0407465, 8A0407465B 8A0407465C	5Z0423812, 6Q0419812C 6Q0423812, 6Q0423812A 6Q0423812C, 6Q0423812D 6R0423812, 8Z0423811A	SK2003 Rotbaşı Sağ Rc7314	
	SK2004 Rotbaşı Sol Rc7313	5Z0423811, 6Q0419811C 6Q0423811, 6Q0423811A 6Q0423811C, 6Q0423811D 6R0423811, 8Z0423812A	6Q0 423 821 B, 6Q0423821B 6X0422803, 6X0422804 6X0422807, 6X0422821	SK3003 Rotmili Sağ-sol 297	
	SK6009 Salıncak Ön Alt Sağ Rd1035	6N0407151, 6Q0407151D* 6Q0407151D, 6Q0407151E* 6Q0407151E, 6Q0407151L 6Q0407151Z, 6Q0407366A*	6N040711, 6Q0407151D* 6Q0407151D, 6Q0407151E* 6Q0407151E, 6Q0407151L 6Q0407151Z, 6Q0407365A*	SK6010 Salıncak Ön Alt Sol Rd1036	

FOX
2003 - 2022

Resim	Ürün Kodu ve Açıklaması	Detay	OEM
	SK20033004 ROT TAKIMI ÖN AKS SAĞ RC788117	Ağırlık : 0,915 kg / 2.017 lb Rotbaşı : SK2003 Rotmilii : SK3004	6Q0422804G, 6Q0423804A
	SK20033007 ROT TAKIMI ÖN AKS SAĞ	Ağırlık : 0,96 kg / 2.116 lb Rotbaşı : SK2003 Rotmilii : SK3007	
	SK20043004 ROT TAKIMI ÖN AKS SOL RC788116	Ağırlık : 0,903 kg / 1.991 lb Rotbaşı : SK2004 Rotmilii : SK3004	6Q0422803G, 6Q0423803A
	SK20043007 ROT TAKIMI ÖN AKS SOL	Ağırlık : 0,96 kg / 2.116 lb Rotbaşı : SK2004 Rotmilii : SK3007	
	AU4001A Z ROT ÖN PLASTİK	Ağırlık : 0,295 kg / 0.650 lb Malzeme Türü : Plastik Uzunluk : 317 mm / 12.48 inch	893407465, 893407465A 8A0407465, 8A0407465B 8A0407465C
	AU4028 Z ROT ÖN	Ağırlık : 0,368 kg / 0.811 lb Malzeme Türü : Metal Uzunluk : 270 mm / 10.63 inch Aşık Diş Çapı : M10X1,5	6Q0411315L, 6Q0411315N 8Z0411315D
	SK6009 SALINCAK ÖN ALT SAĞ RD1035	Ağırlık : 2,676 kg / 5.900 lb Malzeme Türü : Sac Metal	6N0407151, 6Q0407151D* 6Q0407151D, 6Q0407151E* 6Q0407151E, 6Q0407151L 6Q0407151Z, 6Q0407366A*
	SK6009J SALINCAK ÖN ALT RD10211	Ağırlık : 2,626 kg / 5.789 lb Malzeme Türü : Sac Metal	6Q0407151D, 6Q0407151E 6Q0407151L
	SK6009K SALINCAK ÖN ALT SAĞ	Ağırlık : 3,13 kg / 6.900 lb Malzeme Türü : Sac Metal	6N0407151, 6Q0407151D 6Q0407151E, 6Q0407151L 6Q0407151Z
	SK6010 SALINCAK ÖN ALT SOL RD1036	Ağırlık : 3,13 kg / 6.900 lb Malzeme Türü : Sac Metal	6N040711, 6Q0407151D* 6Q0407151D, 6Q0407151E* 6Q0407151E, 6Q0407151L 6Q0407151Z, 6Q0407365A*
	SK6010K SALINCAK ÖN ALT SOL	Ağırlık : 3,13 kg / 6.900 lb Malzeme Türü : Sac Metal	6N040711, 6Q0407151D* 6Q0407151D, 6Q0407151E* 6Q0407151E, 6Q0407151L 6Q0407151Z, 6Q0407365A*



* Bu sayfada ve katalogdaki tüm araçların adları, markaları, modelleri, sembolleri, logoları, orjinal numaraları (oe) ve diğer üçüncü parti numaraları sadece referans amaçlı kullanılmaktadır.

FOX
2003 - 2022

Resim	Ürün Kodu ve Açıklaması	Detay	OEM
	VW11051 SALINCAK VE DENGE KOLU BURCU SOL VE SAĞ	Yön : Sol Ve Sağ Ağırlık : 0.121 kg / 0.267 lb	6Q0407183, 6Q0407183A
	VW12010 TORSİYON BURCU SOL VE SAĞ	Yön : Sol Ve Sağ Ağırlık : 0.31 kg / 0.683 lb	1J0500045, 1J0500045A 1J0501541B, 1J0501541C 6R0501541A, 6R0501541B
	VW12024 VİRAJ DEMİR LASTİĞİ SOL VE SAĞ RUBBER	Şasi (Ön / Arka) : ÖN Yön : Sol Ve Sağ Ağırlık : 0.03 kg / 0.066 lb Malzeme Türü : Rubber Not : VİRAJ LASTİĞİ	6Q0411303AA, 6Q0411303AD 6Q0411305H, 6Q0411314M 6Q0411314Q
	VW12024K VİRAJ DEMİR LASTİĞİ SOL VE SAĞ RUBBER	Şasi (Ön / Arka) : ÖN Yön : Sol Ve Sağ Ağırlık : 0.06 kg / 0.132 lb Malzeme Türü : Rubber Not : VİRAJ LASTİĞİ (İKİLİ)	6Q0411303AA*, 6Q0411303AA 6Q0411303AD*, 6Q0411303AD 6Q0411305H*, 6Q0411305H 6Q0411314M*, 6Q0411314M 6Q0411314Q*, 6Q0411314Q
	VW12050 VİRAJ DEMİR LASTİĞİ SOL VE SAĞ RUBBER	Şasi (Ön / Arka) : ÖN Yön : Sol Ve Sağ Ağırlık : 0.04 kg / 0.088 lb Malzeme Türü : Rubber Not : VİRAJ LASTİĞİ	6Q0411314P
	VW12050K VİRAJ DEMİR LASTİĞİ SOL VE SAĞ RUBBER	Şasi (Ön / Arka) : ÖN Yön : Sol Ve Sağ Ağırlık : 0.08 kg / 0.176 lb Malzeme Türü : Rubber Not : VİRAJ LASTİĞİ (İKİLİ)	6Q0411314P*, 6Q0411314P
	SK12002 AMORTİSÖR TAKOZU ARKA SOL VE SAĞ 1.2 / 1.4TSI / 1.6TDI / 1.2TDI	Şasi (Ön / Arka) : ARKA Yön : Sol Ve Sağ Ağırlık : 0.305 kg / 0.672 lb Not : 1.2 / 1.4TSI / 1.6TDI / 1.2TDI	1J0513353A, 1J0513353B 1J0513353C, 1J0513353G 6QE513353, 6R0513353 6R0513353B
	VW12109 AMORTİSÖR TAKOZU SOL VE SAĞ AMORTİSÖR RULMANI	Yön : Sol Ve Sağ Ağırlık : 0.26 kg / 0.573 lb Not : AMORTİSÖR RULMANI	6N0412249C, 6N0412249E
	VW12109K AMORTİSÖR TAKOZU SOL VE SAĞ 2 PCS	Yön : Sol Ve Sağ Ağırlık : 0.52 kg / 1.146 lb Not : 2 PCS	6N0412249C, 6N0412249E
	VW12028 MOTOR TAKOZU SOL VE SAĞ MOTOR TAKOZU	Yön : Sol Ve Sağ Ağırlık : 1.1 kg / 2.425 lb Not : MOTOR TAKOZU	6Q0199851, 6Q0199851AK
	VW12029 MOTOR TAKOZU SOL VE SAĞ MOTOR TAKOZU	Yön : Sol Ve Sağ Ağırlık : 0.585 kg / 1.290 lb Not : Motor takozu	1K0199855AD, 1K0199855BA 1K0199855K

* Bu sayfada ve katalogdaki tüm araçların adları, markaları, modelleri, sembolleri, logoları, orijinal numaraları (oe) ve diğer üçüncü parti numaraları sadece referans amaçlı kullanılmaktadır.

FOX
2003 - 2022

Resim	Ürün Kodu ve Açıklaması	Detay	OEM
	VW12069 MOTOR TAKOZU SOL VE SAĞ MOTOR TAKOZU	Yön : Sol Ve Sağ Ağırlık : 0.83 kg / 1.830 lb Not : MOTOR TAKOZU	6Q0199851AB, 6Q0199851AK
	VW12083 MOTOR TAKOZU SOL VE SAĞ MOTOR TAKOZU	Yön : Sol Ve Sağ Ağırlık : 1.95 kg / 4.299 lb Not : MOTOR TAKOZU	6Q0199167BC, 6Q0199167BN 6Q0199167CH, 6Q0199167CL 6Q0199167DA, 6Q0199167DB 6Q0199167DL, 6Q0199167DM 6R0199167AA
	VW12036 SÜSPANSİYON TAKOZU SOL VE SAĞ ARKA SUSPANSİYON TAKOZU	Yön : Sol Ve Sağ Ağırlık : 1.591 kg / 3.508 lb Not : ARKA SUSPANSİYON TAKOZU	6Q0512131B
	SK12006 EGZOZ TAKOZU	Ağırlık : 0,185 kg / 0.408 lb	6Q0253144B, 6Q0253144D
	VW14009 AKS KÖRÜĞÜ +KELEPÇE+YAĞ. DIŞ	Ağırlık : 0.16 kg / 0.353 lb	1H0407285B
	AU15001 AMORTİSÖR KÖRÜĞÜ ÖN	Şasi (Ön / Arka) : ÖN Ağırlık : 0,110 kg / 0.243 lb	6N0413175A

FOX
2003 -





Resim	Ürün Kodu ve Açıklaması	Detay	OEM
	AU4001 Z ROT SOL VE SAĞ METAL RB2911	Ağırlık : 0,357 kg / 0.787 lb Malzeme Türü : Metal Uzunluk : 270 mm / 10.63 inch Aşık Diş Çapı : M10X1,5	893407465, 893407465A 8A0407465, 8A0407465B 8A0407465C

GOL
1995 - 2001





Resim	Ürün Kodu ve Açıklaması	Detay	OEM
	VW1035 ROTİL SAĞ	Ağırlık : 0,495 kg / 1.091 lb	305407365.5
	VW1036 ROTİL SOL	Ağırlık : 0,495 kg / 1.091 lb	305407366.5

* Bu sayfada ve katalogdaki tüm araçların adları, markaları, modelleri, sembolleri, logoları, orjinal numaraları (oe) ve diğer üçüncü parti numaraları sadece referans amaçlı kullanılmaktadır.

GOL
1995 - 2001

Resim	Ürün Kodu ve Açıklaması	Detay	OEM
	VW1037 ROTİL ÖN ALT SAĞ	Ağırlık : 0,625 kg / 1.378 lb	377407366A
	VW1038 ROTİL ÖN ALT SOL	Ağırlık : 0,609 kg / 1.343 lb	377407365A
	VW2027 ROTBAŞI 60 MM	Ağırlık : 0,282 kg / 0.622 lb Uzunluk : 60 mm / 2.36 inch Gövde Diş Çapı : M14X1,5 Aşık Diş Çapı : M10X1,25 Aşık Konik Çapı : Ø10,8	307419812.1
	VW2028 ROTBAŞI ÖN SAĞ - SOL	Ağırlık : 0,293 kg / 0.646 lb	3054198113

GOL
2001 - 2009

Resim	Ürün Kodu ve Açıklaması	Detay	OEM
	VW2001 ROTBAŞI SAĞ RD0347	Ağırlık : 0,87 kg / 1.918 lb Uzunluk : 180 mm / 7.09 inch Gövde Diş Çapı : M14X2 Aşık Diş Çapı : M12X1,75 Aşık Konik Çapı : Ø13,2	7L0422818B, 7L0422818C 7L0422818D, 95534713220
	VW2002 ROTBAŞI SOL RD0346	Ağırlık : 0,87 kg / 1.918 lb Uzunluk : 93 mm / 3.66 inch Gövde Diş Çapı : M16X1,5 Aşık Diş Çapı : M14X1,5 Aşık Konik Çapı : Ø16,6	7L0422817B, 7L0422817C 7L0422817D, 95534713221
	VW3001 ROTMİLİ SAĞ-SOL 288 RD08226	Ağırlık : 0,692 kg / 1.526 lb Uzunluk : 288 mm / 11.34 inch Gövde Diş Çapı : M16X1,5 Aşık Diş Çapı : M16X1,5	1160310016, 7L0422803B 7L0422803C, 7L0422804B 7L0422804C, 7L0422821 7L0422821B, 7L0422821D
	VW20013001 ROT TAKIMI ÖN AKS SAĞ	Ağırlık : 1,285 kg / 2.833 lb Rotbaşı : VW2001 Rotmilî : VW3001	7L0422804B, 7L0422804C 7L0422804D, 955347032021
	VW20023001 ROT TAKIMI ÖN AKS SOL	Ağırlık : 1,27 kg / 2.800 lb Rotbaşı : VW2002 Rotmilî : VW3001	7L0422803B, 7L0422803C 7L0422803D, 955347032020
	VW4002 Z ROT ARKA SAĞ 201 RD0943	Ağırlık : 0,535 kg / 1.179 lb Malzeme Türü : Metal Uzunluk : 201 mm / 7.91 inch Aşık Diş Çapı : M12X1,5	7L0505466A, 95533307010





* Bu sayfada ve katalogdaki tüm araçların adları, markaları, modelleri, sembolleri, logoları, orjinal numaraları (oe) ve diğer üçüncü parti numaraları sadece referans amaçlı kullanılmaktadır.

GOL
2001 - 2009





Resim	Ürün Kodu ve Açıklaması	Detay	OEM
	VW4003 Z ROT ARKA SOL 201 RD0944	Ağırlık : 0,534 kg / 1.177 lb Malzeme Türü : Metal Uzunluk : 201 mm / 7.91 inch Aşık Diş Çapı : M12X1,5	7L0505465A, 7L0505465B 95533306910, 95533306921 95533307011
	AU9005 SALINCAK ARKA	Ağırlık : 1,36 kg / 2.998 lb Malzeme Türü : Sac Metal	7L8501529, 7L8501529A 95533104530, 95533104531 95533104532
	VW5003 SALINCAK ÖN	Ağırlık : 0,230 kg / 0.507 lb Malzeme Türü : Alüminyum	7L0411317, 95534306900
	VW5004 SALINCAK ARKA ÜST	Ağırlık : 0,860 kg / 1.896 lb Malzeme Türü : Alüminyum	7L0505323A, 95533104710
	VW6027 SALINCAK ÖN ÜST RB3017	Ağırlık : 1,1 kg / 2.425 lb Malzeme Türü : Alüminyum	7L0407021, 7L0407021A 7L0407021B, 95534102701 95534102702
	VW6028 SALINCAK ÖN ALT SAĞ RD1048	Ağırlık : 10,302 kg / 22.712 lb Malzeme Türü : Döküm Çelik	7L0407152C, 7L0407152D 7L0407152E, 7L0407152H 95534101830, 95534101831 95534101832, 95534101833
	VW6029 SALINCAK ÖN ALT SOL RD1049	Ağırlık : 10,302 kg / 22.712 lb Malzeme Türü : Döküm Çelik	7L0407151C, 7L0407151D 7L0407151E, 7L0407151H 95534101730, 95534101731 95534101733
	AU11020 SALINCAK VE DENG KOLU BURCU ÖN ALT SOL VE SAĞ	Şasi (Ön / Arka) : ÖN Yön : Alt Sol Ve Sağ Ağırlık : 0,22 kg / 0.485 lb	7L0407183, 7L0407183A 95534158810
	AU11026 SALINCAK VE DENG KOLU BURCU ÖN ORTA SOL VE SAĞ	Şasi (Ön / Arka) : ÖN Yön : Orta Sol Ve Sağ Ağırlık : 0,272 kg / 0.600 lb	7L0412333A
	AU11037 SALINCAK VE DENG KOLU BURCU ARKA SOL VE SAĞ	Şasi (Ön / Arka) : ARKA Yön : Sol Ve Sağ Ağırlık : 0,222 kg / 0.489 lb Not : DENG KOLU BURCU	7L8501529A-P
	AU11067 SALINCAK VE DENG KOLU BURCU ARKA SOL VE SAĞ	Şasi (Ön / Arka) : ARKA Yön : Sol Ve Sağ Not : DENG KOLU BURCU	7L8501529A-P

* Bu sayfada ve katalogdaki tüm araçların adları, markaları, modelleri, sembolleri, logoları, orjinal numaraları (oe) ve diğer üçüncü parti numaraları sadece referans amaçlı kullanılmaktadır.

GOL
2001 - 2009











Resim	Ürün Kodu ve Açıklaması	Detay	OEM
	VW11026 SALINCAK VE DENGE KOLU BURCU SOL VE SAĞ	Yön : Sol Ve Sağ Ağırlık : 0,25 kg / 0.551 lb	7L0407182C, 7L0407182E 95534124203
	VW11038 SALINCAK VE DENGE KOLU BURCU ÜST SOL VE SAĞ	Yön : Üst Sol Ve Sağ Ağırlık : 0.16 kg / 0.353 lb Not : ARKA DENGE KOL BURCU DÜZ	7L0505323A, 7L0505553
	VW11039 SALINCAK VE DENGE KOLU BURCU ARKA SOL VE SAĞ	Şasi (Ön / Arka) : ARKA Yön : Sol Ve Sağ Ağırlık : 0.12 kg / 0.265 lb Not : ARKA DENGE KOL BURCU 12MM	7L0505554
	VW11048 SALINCAK VE DENGE KOLU BURCU SOL VE SAĞ	Yön : Sol Ve Sağ Ağırlık : 0,262 kg / 0.578 lb	7L0411317 (p), 7L0411317-P
	VW11061 SALINCAK VE DENGE KOLU BURCU ÜST SOL VE SAĞ	Yön : Üst Sol Ve Sağ Ağırlık : 0,178 kg / 0.392 lb	7L0407021A, 7L0407021B 7L0407077

GOL
2009 - 2016









Resim	Ürün Kodu ve Açıklaması	Detay	OEM
	SK1025 ROTİL SAĞ	Ağırlık : 0,59 kg / 1.301 lb Konik Ölçüsü : Ø15 Bağlantı Delik Çapı : Ø10,5 Aşık Diş Çapı : M12X1,5	5U0407366A, 6R0407366 6R0407366A, 6R0407366B
	SK1026 ROTİL ÖN ALT SOL Ø15	Ağırlık : 0,59 kg / 1.301 lb Konik Ölçüsü : Ø15 Bağlantı Delik Çapı : Ø10,5 Aşık Diş Çapı : M12X1,5	5U0407365A, 6R0407365 6R0407365A, 6R0407365B
	SK2003 ROTBAŞI SAĞ RC7314	Ağırlık : 0,377 kg / 0.831 lb Uzunluk : 93,5 mm / 3.68 inch Gövde Diş Çapı : M14X1,5 Aşık Diş Çapı : M12X1,5 Aşık Konik Çapı : Ø13,5	5Z0423812, 6Q0419812C 6Q0423812, 6Q0423812A 6Q0423812C, 6Q0423812D 6R0423812, 8Z0423811A
	SK2004 ROTBAŞI SOL RC7313	Ağırlık : 0,382 kg / 0.842 lb Uzunluk : 93 mm / 3.66 inch Gövde Diş Çapı : M14X1,5 Aşık Diş Çapı : M12X1,5 Aşık Konik Çapı : Ø13,5	5Z0423811, 6Q0419811C 6Q0423811, 6Q0423811A 6Q0423811C, 6Q0423811D 6R0423811, 8Z0423812A
	SK3004 ROTMİLİ SAĞ-SOL 300 RC7817	Ağırlık : 0,536 kg / 1.182 lb Uzunluk : 300 mm / 11.81 inch Gövde Diş Çapı : M16X1,5 Aşık Diş Çapı : M14X1,5	6Q0423803A, 6Q0423804A 6Q0-423-810-C, 6Q0423821A 6Q0423821C, 6Q0423821G

* Bu sayfada ve katalogdaki tüm araçların adları, markaları, modelleri, sembolleri, logoları, orjinal numaraları (oe) ve diğer üçüncü parti numaraları sadece referans amaçlı kullanılmaktadır.

GOL
2009 - 2016

Resim	Ürün Kodu ve Açıklaması	Detay	OEM
	SK20033003 ROT TAKIMI ÖN AKS SAĞ RC788115	Ağırlık : 1,021 kg / 2.251 lb Rotbaşı : SK2003 Rotmilii : SK3003	6Q0422804B, 6Q0423804B
	SK20033004 ROT TAKIMI ÖN AKS SAĞ RC788117	Ağırlık : 0,915 kg / 2.017 lb Rotbaşı : SK2003 Rotmilii : SK3004	6Q0422804G, 6Q0423804A
	AU4028 Z ROT ÖN	Ağırlık : 0,368 kg / 0.811 lb Malzeme Türü : Metal Uzunluk : 270 mm / 10.63 inch Aşık Diş Çapı : M10X1,5	6Q0411315L, 6Q0411315N 8Z0411315D
	SK6013 SALINCAK ÖN ALT SAĞ	Ağırlık : 3,445 kg / 7.595 lb Malzeme Türü : Sac Metal	6R0407152, 6R0407152E
	SK6013J SALINCAK ÖN ALT SAĞ	Ağırlık : 2,88 kg / 6.349 lb Malzeme Türü : Sac Metal	6R0407152
	SK6014 SALINCAK ÖN ALT SOL	Ağırlık : 3,445 kg / 7.595 lb Malzeme Türü : Sac Metal	6R0407151, 6R0407151E
	SK6014J SALINCAK ÖN ALT SOL	Ağırlık : 2,88 kg / 6.349 lb Malzeme Türü : Sac Metal	6R0407151, 6R0407151E
	AU11002 SALINCAK VE DENGE KOLU BURCU ÖN SOL VE SAĞ B22117	Şasi (Ön / Arka) : ÖN Yön : Sol Ve Sağ Ağırlık : 0,108 kg / 0.238 lb	1J0407181, 1J0407181A
	AU11005 SALINCAK VE DENGE KOLU BURCU ÖN ORTA SOL VE SAĞ B40115	Şasi (Ön / Arka) : ÖN Yön : Orta Sol Ve Sağ Ağırlık : 0,111 kg / 0.245 lb Not : VW6014 - VW60614J	191407182, 357407182 357407182F
	SE12005 MOTOR TAKOZU ARKA	Şasi (Ön / Arka) : ARKA Ağırlık : 1,115 kg / 2.458 lb	6Q0199851AS, 6Q0199851T

GOLF
I MK1, A1
1974 - 1984

Resim	Ürün Kodu ve Açıklaması	Detay	OEM
	VW1005 ROTİL ALT SOL VE SAĞ RD0512	Ağırlık : 0,346 kg / 0.763 lb Bağlantı Delik Çapı : Ø7,5	171407365C, 171407365D
	VW1006 ROTİL SAĞ RD0513	Ağırlık : 0,35 kg / 0.772 lb Bağlantı Delik Çapı : Ø7,5	171407365F, 171407365G
	VW2003 ROTBAŞI SAĞ-SOL RD0339	Ağırlık : 0,3 kg / 0.661 lb Uzunluk : 79 mm / 3.11 inch Gövde Diş Çapı : M14X1,5 Aşık Diş Çapı : M12X1,5 Aşık Konik Çapı : Ø12,3	171419811, 171419811A 171419812, 251419811 32111116463, 477419811 477419815, 94434733300
	VW3002 ROTMİLİ RD0811	Ağırlık : 0,665 kg / 1.466 lb Uzunluk : 342 mm / 13.46 inch Gövde Diş Çapı : M22X1,5 Aşık Diş Çapı : M14X1,5	171419821, 171419821A
	VW3019 ROTMİLİ ÖN SAĞ - SOL	Ağırlık : 0.55 kg / 1.213 lb Gövde Diş Çapı : M14X1,5 RHT	175422821
	VW20033002 ROT TAKIMI SOL VE SAĞ	Ağırlık : 0,963 kg / 2.123 lb Rotbaşı : VW2003 Rotmili : VW3002	171 419 804, 171419804
	VW20033019 ROT TAKIMI ÖN AKS RD088145	Ağırlık : 0.85 kg / 1.874 lb Rotbaşı : VW2003 Rotmili : VW3019	155422803, 155422803A 175422803
	VW6001 SALINCAĞ ÖN ALT SAĞ	Ağırlık : 3,652 kg / 8.051 lb Malzeme Türü : Sac Metal	171407153D
	VW6001J SALINCAĞ ÖN ALT	Ağırlık : 2,236 kg / 4.930 lb Malzeme Türü : Sac Metal	171407153D
	VW6002 SALINCAĞ ÖN ALT SOL RD1047	Ağırlık : 2,668 kg / 5.882 lb Malzeme Türü : Sac Metal	171407153D
	VW11004 SALINCAĞ VE DENGE KOLU BURCU SOL VE SAĞ B40112	Yön : Sol Ve Sağ Ağırlık : 0,121 kg / 0.267 lb	171407181, 171407181A

* Bu sayfada ve katalogdaki tüm araçların adları, markaları, modelleri, sembolleri, logoları, orjinal numaraları (oe) ve diğer üçüncü parti numaraları sadece referans amaçlı kullanılmaktadır.

GOLF
I MK1, A1
1974 - 1984



Resim	Ürün Kodu ve Açıklaması	Detay	OEM
	VW11005 SALINCAK VE DENGE KOLU BURCU ORTA SOL VE SAĞ B40113	Yön : Orta Sol Ve Sağ Ağırlık : 0,087 kg / 0.192 lb	171407182D, 171407182E
	VW12004 AMORTİSÖR TAKOZU SOL VE SAĞ AMORTİSOR TABLASI	Yön : Sol Ve Sağ Ağırlık : 0.786 kg / 1.733 lb Not : AMORTİSOR TABLASI	171412329, 171412329A
	VW12009 MOTOR TAKOZU SOL VE SAĞ MOTOR TAKOZU	Yön : Sol Ve Sağ Ağırlık : 0,288 kg / 0.635 lb Not : MOTOR TAKOZU	171199214D, 171399113D
	VW12091 MOTOR TAKOZU SOL VE SAĞ MOTOR TAKOZU	Yön : Sol Ve Sağ Ağırlık : 0,289 kg / 0.637 lb Not : MOTOR TAKOZU	171199214G
	VW12003 SÜSPANSİYON TAKOZU SOL VE SAĞ AMARTİSÖR TAKOZU ARKA	Yön : Sol Ve Sağ Ağırlık : 0,076 kg / 0.168 lb Not : AMARTİSÖR TAKOZU ARKA	171512131B
	VW12089 SÜSPANSİYON TAKOZU SOL VE SAĞ SÜSPANSİYON TAKOZU	Yön : Sol Ve Sağ Ağırlık : 0.15 kg / 0.331 lb Not : SÜSPANSİYON TAKOZU	191412303A, 357412303E
	AU12012 EGSOZ TAKOZU ÖN SOL VE SAĞ EGSOZ LASTİĞİ	Şasi (Ön / Arka) : ÖN Yön : Sol Ve Sağ Ağırlık : 0.034 kg / 0.075 lb Not : EGSOZ LASTİĞİ	191253147B, 4A0253147A
	VW13008 DİREKSİYON KÖRÜĞÜ	Ağırlık : 0.225 kg / 0.496 lb	1H0422831B
	VW13010 DİREKSİYON KÖRÜĞÜ ÖN	Ağırlık : 0,124 kg / 0.273 lb	191422831
	OP14003 AKS KÖRÜĞÜ +KELEPÇE+YAĞ. AKS KÖRÜĞÜ DIŞ	Ağırlık : 0.2 kg / 0.441 lb	1603180
	RN14006 AKS KÖRÜĞÜ +KELEPÇE+YAĞ. DIŞ	Ağırlık : 0.2 kg / 0.441 lb	1603180, 1603204 16410170470106*, 16500170470106* 1H0498203, 271648 271649, 321498203A 431498203C, 443498203D

* Bu sayfada ve katalogdaki tüm araçların adları, markaları, modelleri, sembolleri, logoları, orijinal numaraları (oe) ve diğer üçüncü parti numaraları sadece referans amaçlı kullanılmaktadır.

GOLF
I MK1, A1
1974 - 1984

Resim	Ürün Kodu ve Açıklaması	Detay	OEM
	VW14013 AKS KÖRÜĞÜ +KELEPÇE+YAĞ. YAĞ+KELEPÇE	Ağırlık : 0.156 kg / 0.344 lb	113501149, 171407283A
	VW14014 AKS KÖRÜĞÜ +KELEPÇE+YAĞ. YAĞ+KELEPÇE	Ağırlık : 0.28 kg / 0.617 lb	191498203C, 71498203

GOLF
II MK2, A2
1983 - 1992

Resim	Ürün Kodu ve Açıklaması	Detay	OEM
	VW1011 ROTİL D= Ø17	Ağırlık : 0,39 kg / 0.860 lb Bağlantı Delik Çapı : Ø8,5	191407365, 191407365B
	VW1011K ROTİL ALT SAĞ-SOL Ø17 RD0514	Ağırlık : 0,435 kg / 0.959 lb Bağlantı Delik Çapı : Ø8,5	191.407.365F, 191407365 191407365B*, 191407365F
	VW1012 ROTİL ALT SOL VE SAĞ	Ağırlık : 0,353 kg / 0.778 lb Bağlantı Delik Çapı : Ø8,5	357407365, 357407365A
	VW1012K ROTİL ALT SAĞ-SOL 19 RD0515	Ağırlık : 0,445 kg / 0.981 lb Bağlantı Delik Çapı : Ø8,5	357407365, 357407365A* 357407365A, 357407365S 357407365-S1
	VW2006 ROTBAŞI SAĞ RD0312	Ağırlık : 0,3 kg / 0.661 lb Uzunluk : 76 mm / 2.99 inch Gövde Diş Çapı : M14X1,5 Aşık Diş Çapı : M12X1,5 Aşık Konik Çapı : Ø12,7	191419812, 22190091617 6N0419812, 6N0422812 XA2087
	VW2007 ROTBAŞI SOL RD0311	Ağırlık : 0,3 kg / 0.661 lb Uzunluk : 76 mm / 2.99 inch Gövde Diş Çapı : M14X1,5 Aşık Diş Çapı : M12X1,5 Aşık Konik Çapı : Ø12,7	191419811, 22190090617 6N0419811, 6N0422811 XA2084
	VW3003 ROTMİLİ SAĞ-SOL RD0817	Ağırlık : 0,678 kg / 1.495 lb Uzunluk : 340 mm / 13.39 inch Gövde Diş Çapı : M22X1,5 Aşık Diş Çapı : M14X1,5	191419721, 191419803 191419803-PART, 191419804* 191419804, 191419807A 191419821
	VW3004 ROTMİLİ ÖN SAĞ - SOL 338 RD0887	Ağırlık : 0,605 kg / 1.334 lb Uzunluk : 338 mm / 13.31 inch Gövde Diş Çapı : M14X1,5 Aşık Diş Çapı : M14X1,5	191407153, 191422721 191422803A, 191422804A 191422807, 191422807A 191422821, 191422821A 6K0422821







* Bu sayfada ve katalogdaki tüm araçların adları, markaları, modelleri, sembolleri, logoları, orjinal numaraları (oe) ve diğer üçüncü parti numaraları sadece referans amaçlı kullanılmaktadır.

GOLF
II MK2, A2
1983 - 1992

Resim	Ürün Kodu ve Açıklaması	Detay	OEM
	VW20063003 ROT TAKIMI SAĞ RD088116	Ağırlık : 0,984 kg / 2.169 lb Rotbaşı : VW2006 Rotmilii : VW3003	191419804, 191419804A
	VW20063004 ROT TAKIMI ÖN AKS SAĞ	Ağırlık : 0,991 kg / 2.185 lb Rotbaşı : VW2006 Rotmilii : VW3004	191422804A
	VW20073003 ROT TAKIMI SOL RD088115	Ağırlık : 0,978 kg / 2.156 lb Rotbaşı : VW2007 Rotmilii : VW3003	191419803, 191419803A
	VW20073004 ROT TAKIMI SOL RD088118	Ağırlık : 0,991 kg / 2.185 lb Rotbaşı : VW2007 Rotmilii : VW3004	191422803, 191422803A
	VW4004 Z ROT ÖN SAĞ - SOL KOMPLE RD0942	Ağırlık : 0,189 kg / 0.417 lb Malzeme Türü : Komple Uzunluk : 75 mm / 2.95 inch	191411315, 191411315B 191411315BKIT, 191411315BS
	VW4029 Z ROT ÖN SAĞ - SOL	Ağırlık : 0,166 kg / 0.366 lb Uzunluk : 77 mm / 3.03 inch	191411315B
	VW6004 SALINCAK ÖN SAĞ	Ağırlık : 3,21 kg / 7.077 lb Malzeme Türü : Sac Metal	191407151A
	VW60046005K SALINCAK ÖN	Ağırlık : 3.8 kg / 8.378 lb Malzeme Türü : Sac Metal	
	VW6004J SALINCAK ÖN RD1103	Ağırlık : 2,605 kg / 5.743 lb Malzeme Türü : Sac Metal	191.407.151B, 191407151A 191407151B
	VW6005 SALINCAK ÖN SOL	Ağırlık : 3,21 kg / 7.077 lb Malzeme Türü : Sac Metal	192407151A
	VW6006 SALINCAK ÖN SAĞ RD1019	Ağırlık : 3,166 kg / 6.980 lb Malzeme Türü : Sac Metal	191407151B, 191407175 191411315B, 191411331 357407365A, 6N0411329 N0111849, N10127702



* Bu sayfada ve katalogdaki tüm araçların adları, markaları, modelleri, sembolleri, logoları, orjinal numaraları (oe) ve diğer üçüncü parti numaraları sadece referans amaçlı kullanılmaktadır.

GOLF
II MK2, A2
1983 - 1992

Resim	Ürün Kodu ve Açıklaması	Detay	OEM
	VW60066007K SALINCAK ÖN	Ağırlık : 3.3 kg / 7.275 lb Malzeme Türü : Sac Metal	
	VW600674008K SALINCAK ÖN	Ağırlık : 3.466 kg / 7.641 lb Malzeme Türü : Sac Metal	
	VW6007 SALINCAK ÖN SOL RD1029	Ağırlık : 3,088 kg / 6.808 lb Malzeme Türü : Sac Metal	191407151A
	AU11005 SALINCAK VE DENGE KOLU BURCU ÖN ORTA SOL VE SAĞ B40115	Şasi (Ön / Arka) : ÖN Yön : Orta Sol Ve Sağ Ağırlık : 0,111 kg / 0.245 lb Not : VW6014 - VW60614J	191407182, 357407182 357407182F
	VW11001 SALINCAK VE DENGE KOLU BURCU SOL VE SAĞ B40114	Yön : Sol Ve Sağ Ağırlık : 0.141 kg / 0.311 lb	191407181D, 191407181E 357407181
	VW11024 SALINCAK VE DENGE KOLU BURCU SOL VE SAĞ	Yön : Sol Ve Sağ Ağırlık : 0,204 kg / 0.450 lb	191407181A, 191407181B
	VW11840 BURÇ	Yön : Sol Ve Sağ Ağırlık : 0,149 kg / 0.328 lb	357407181
	VW12060 TORSİYON BURCU SOL VE SAĞ	Yön : Sol Ve Sağ Ağırlık : 0,459 kg / 1.012 lb	191501541
	VW12037 VİRAJ DEMİR LASTİĞİ SOL VE SAĞ RUBBER	Şasi (Ön / Arka) : ÖN Yön : Sol Ve Sağ Ağırlık : 0.11 kg / 0.243 lb Malzeme Türü : Rubber Not : VİRAJ DEMİR LASTİĞİ ÖN	191411314
	VW12037K VİRAJ DEMİR LASTİĞİ SOL VE SAĞ RUBBER	Şasi (Ön / Arka) : ÖN Yön : Sol Ve Sağ Ağırlık : 0.22 kg / 0.485 lb Malzeme Türü : Rubber	191411314*
	VW12053 VİRAJ DEMİR LASTİĞİ SOL VE SAĞ RUBBER	Şasi (Ön / Arka) : ÖN Yön : Sol Ve Sağ Ağırlık : 0.06 kg / 0.132 lb Malzeme Türü : Rubber Not : VİRAJ LASTİĞİ	1H0411314

* Bu sayfada ve katalogdaki tüm araçların adları, markaları, modelleri, sembolleri, logoları, orjinal numaraları (oe) ve diğer üçüncü parti numaraları sadece referans amaçlı kullanılmaktadır.

GOLF
II MK2, A2
1983 - 1992

Resim	Ürün Kodu ve Açıklaması	Detay	OEM
	VW12053K VİRAJ DEMİR LASTİĞİ SOL VE SAĞ RUBBER	Şasi (Ön / Arka) : ÖN Yön : Sol Ve Sağ Ağırlık : 0.12 kg / 0.265 lb Malzeme Türü : Rubber	1H0411314*
	VW12111 VİRAJ DEMİR LASTİĞİ SOL VE SAĞ RUBBER	Şasi (Ön / Arka) : ÖN Yön : Sol Ve Sağ Ağırlık : 0.015 kg / 0.033 lb Malzeme Türü : Rubber Not : VİRAJ LASTİĞİ	191411329, 6N0411329
	VW12111K VİRAJ DEMİR LASTİĞİ SOL VE SAĞ RUBBER	Şasi (Ön / Arka) : ÖN Yön : Sol Ve Sağ Ağırlık : 0.03 kg / 0.066 lb Malzeme Türü : Rubber	191411329*, 6N0411329*
	VW12001 AMORTİSÖR TAKOZU SOL VE SAĞ AMORTİSÖR TAKOZU	Yön : Sol Ve Sağ Ağırlık : 0.644 kg / 1.420 lb Not : AMORTİSÖR TAKOZU	176412329, 191412329 191412331
	VW12005 AMORTİSÖR TAKOZU SOL VE SAĞ AMORTİSÖR ÜST TAKOZU	Yön : Sol Ve Sağ Ağırlık : 0.1 kg / 0.220 lb Not : AMORTİSÖR ÜST TAKOZU	191512333
	VW12058 AMORTİSÖR TAKOZU SOL VE SAĞ	Yön : Sol Ve Sağ Ağırlık : 0.654 kg / 1.442 lb	357412329
	VW12065 AMORTİSÖR TAKOZU SOL VE SAĞ AMORTİSÖR KEPİ	Yön : Sol Ve Sağ Ağırlık : 0.377 kg / 0.831 lb Not : AMORTİSÖR KEPİ	191 512 113, 191512113
	VW12065K AMORTİSÖR TAKOZU ÖN SOL VE SAĞ 2 PCS	Şasi (Ön / Arka) : ÖN Yön : Sol Ve Sağ Ağırlık : 0.758 kg / 1.671 lb Not : 2 PCS	191512113
	VW12002 MOTOR TAKOZU SOL VE SAĞ ŞANZUMAN TAKOZU	Yön : Sol Ve Sağ Ağırlık : 0.68 kg / 1.499 lb Not : ŞANZUMAN TAKOZU	191199402, 191199402A 191199402AC, 191199402B 191199402C
	VW12007 MOTOR TAKOZU SAĞ MOTOR TAKOZU SAĞ	Yön : Sağ Ağırlık : 1,193 kg / 2.630 lb Not : MOTOR TAKOZU SAĞ	91199262A
	VW12095 MOTOR TAKOZU SOL VE SAĞ MOTOR TAKOZU	Yön : Sol Ve Sağ Ağırlık : 1,389 kg / 3.062 lb Not : MOTOR TAKOZU	191199272, 191199272A 191199273, 191199279B 191199279C, 191199279D 357199279C

* Bu sayfada ve katalogdaki tüm araçların adları, markaları, modelleri, sembolleri, logoları, orjinal numaraları (oe) ve diğer üçüncü parti numaraları sadece referans amaçlı kullanılmaktadır.

GOLF
II MK2, A2
1983 - 1992

Resim	Ürün Kodu ve Açıklaması	Detay	OEM
	VW12088 SÜSPANSİYON TAKOZU SOL VE SAĞ SÜSPANSİYON TAKOZU ARKA	Yön : Sol Ve Sağ Ağırlık : 0.11 kg / 0.243 lb Not : SÜSPANSİYON TAKOZU ARKA	191512131B
	VW12089 SÜSPANSİYON TAKOZU SOL VE SAĞ SÜSPANSİYON TAKOZU	Yön : Sol Ve Sağ Ağırlık : 0.15 kg / 0.331 lb Not : SÜSPANSİYON TAKOZU	191412303A, 357412303E
	AU12012 EGZOZ TAKOZU ÖN SOL VE SAĞ EGZOZ LASTİĞİ	Şasi (Ön / Arka) : ÖN Yön : Sol Ve Sağ Ağırlık : 0.034 kg / 0.075 lb Not : EGZOZ LASTİĞİ	191253147B, 4A0253147A
	VW13008 DİREKSİYON KÖRÜĞÜ	Ağırlık : 0.225 kg / 0.496 lb	1H0422831B
	VW13010 DİREKSİYON KÖRÜĞÜ ÖN	Ağırlık : 0,124 kg / 0.273 lb	191422831
	OP14003 AKS KÖRÜĞÜ +KELEPÇE+YAĞ. AKS KÖRÜĞÜ DIŞ	Ağırlık : 0.2 kg / 0.441 lb	1603180
	RN14006 AKS KÖRÜĞÜ +KELEPÇE+YAĞ. DIŞ	Ağırlık : 0.2 kg / 0.441 lb	1603180, 1603204 16410170470106*, 16500170470106* 1H0498203, 271648 271649, 321498203A 431498203C, 443498203D
	VW14013 AKS KÖRÜĞÜ +KELEPÇE+YAĞ. YAĞ+KELEPÇE	Ağırlık : 0.156 kg / 0.344 lb	113501149, 171407283A
	VW14014 AKS KÖRÜĞÜ +KELEPÇE+YAĞ. YAĞ+KELEPÇE	Ağırlık : 0.28 kg / 0.617 lb	191498203C, 71498203

GOLF
III MK3, A3
1991 - 1998

Resim	Ürün Kodu ve Açıklaması	Detay	OEM
	VW1012 ROTİL ALT SOL VE SAĞ	Ağırlık : 0,353 kg / 0.778 lb Bağlantı Delik Çapı : Ø8,5	357407365, 357407365A











* Bu sayfada ve katalogdaki tüm araçların adları, markaları, modelleri, sembolleri, logoları, orjinal numaraları (oe) ve diğer üçüncü parti numaraları sadece referans amaçlı kullanılmaktadır.

GOLF
III MK3, A3
1991 - 1998

Resim	Ürün Kodu ve Açıklaması	Detay	OEM
	VW1012K ROTİL ALT SAĞ-SOL 19 RD0515	Ağırlık : 0,445 kg / 0.981 lb Bağlantı Delik Çapı : Ø8,5	357407365, 357407365A* 357407365A, 357407365S 357407365-S1
	VW1013 ROTİL ÖN ALT Ø16,5 RD0519	Ağırlık : 0,415 kg / 0.915 lb Konik Ölçüsü : Ø16,5 Bağlantı Delik Çapı : Ø8,5 Aşık Diş Çapı : M12X1,5	1H0407365
	VW1013K ROTİL	Ağırlık : 0,495 kg / 1.091 lb Konik Ölçüsü : Ø16,5 Bağlantı Delik Çapı : Ø8,5 Aşık Diş Çapı : M12X1,5	1H0407365*, 1H0407365
	VW2006 ROTBAŞI SAĞ RD0312	Ağırlık : 0,3 kg / 0.661 lb Uzunluk : 76 mm / 2.99 inch Gövde Diş Çapı : M14X1,5 Aşık Diş Çapı : M12X1,5 Aşık Konik Çapı : Ø12,7	191419812, 22190091617 6N0419812, 6N0422812 XA2087
	VW2007 ROTBAŞI SOL RD0311	Ağırlık : 0,3 kg / 0.661 lb Uzunluk : 76 mm / 2.99 inch Gövde Diş Çapı : M14X1,5 Aşık Diş Çapı : M12X1,5 Aşık Konik Çapı : Ø12,7	191419811, 22190090617 6N0419811, 6N0422811 XA2084
	VW3007 ROTMİLİ ÖN SAĞ - SOL 369 RD0823	Ağırlık : 0,703 kg / 1.550 lb Uzunluk : 369 mm / 14.53 inch Gövde Diş Çapı : M22X1,5 Aşık Diş Çapı : M14X1,5	1H0419821
	VW3008 ROTMİLİ SAĞ-SOL 371 RD0826	Ağırlık : 0,652 kg / 1.437 lb Uzunluk : 371 mm / 14.61 inch Gövde Diş Çapı : M14X1,5 Aşık Diş Çapı : M14X1,5	1H0422803, 1H0422804 1H0422821, 803419811
	VW20063007 ROT TAKIMI ÖN AKS SAĞ RD088121	Ağırlık : 1,003 kg / 2.211 lb Rotbaşı : VW2006 Rotmilî : VW3007	1H0419804, 1H0419804A
	VW20063008 ROT TAKIMI ÖN AKS SAĞ RD088125	Ağırlık : 0,947 kg / 2.088 lb Rotbaşı : VW2006 Rotmilî : VW3008	1H0422804, 1H0422804A
	VW20073007 ROT TAKIMI ÖN AKS SOL RD088122	Ağırlık : 1,006 kg / 2.218 lb Rotbaşı : VW2007 Rotmilî : VW3007	1H0419803, 357419803A
	VW20073008 ROT TAKIMI SOL RD088124	Ağırlık : 0,956 kg / 2.108 lb Rotbaşı : VW2007 Rotmilî : VW3008	1H0422803

* Bu sayfada ve katalogdaki tüm araçların adları, markaları, modelleri, sembolleri, logoları, orijinal numaraları (oe) ve diğer üçüncü parti numaraları sadece referans amaçlı kullanılmaktadır.

GOLF
III MK3, A3
1991 - 1998

Resim	Ürün Kodu ve Açıklaması	Detay	OEM
	VW4008 Z ROT ÖN SAĞ - SOL METAL RD0923	Ağırlık : 0,166 kg / 0.366 lb Malzeme Türü : Metal Uzunluk : 77 mm / 3.03 inch Aşık Diş Çapı : M8X1,25	191411315A, 191411315B 191411315BK
	VW4009 Z ROT ÖN SAĞ-SOL METAL 51 RD0911	Ağırlık : 0,15 kg / 0.331 lb Malzeme Türü : Metal Uzunluk : 51 mm / 2.01 inch Aşık Diş Çapı : M10X1,5	535411315
	VW4023 Z ROT ÖN SAĞ - SOL	Ağırlık : 0,195 kg / 0.430 lb Uzunluk : 78 mm / 3.07 inch Aşık Diş Çapı : M12X1,5	191411315A, 191411327
	VW6012 SALINCAK ALT SAĞ S725	Ağırlık : 2,754 kg / 6.072 lb Malzeme Türü : Sac Metal	191407153, 1H0407151
	VW60126013K SALINCAK ÖN	Ağırlık : 3,15 kg / 6.945 lb Malzeme Türü : Sac Metal	
	VW6012J SALINCAK ÖN SAĞ - SOL RD1104	Ağırlık : 2,32 kg / 5.115 lb Malzeme Türü : Sac Metal	1H0407151
	VW6013 SALINCAK ALT SOL S726	Ağırlık : 2,754 kg / 6.072 lb Malzeme Türü : Sac Metal	191407151A, 1H0407151 1H0407152
	VW6014 SALINCAK ÖN SAĞ RD1021	Ağırlık : 3,966 kg / 8.744 lb Malzeme Türü : Sac Metal	1H0407152*
	VW6014J SALINCAK ÖN SAĞ RD1106	Ağırlık : 3,35 kg / 7.385 lb Malzeme Türü : Sac Metal	1H0407152
	VW6015 SALINCAK ÖN SOL RD1022	Ağırlık : 3,674 kg / 8.100 lb Malzeme Türü : Sac Metal	1H0407151A *, 1H0407151A*
	VW6015J SALINCAK ÖN SOL RD1105	Ağırlık : 3,152 kg / 6.949 lb Malzeme Türü : Sac Metal	1H0.407.151A, 1H0407151 1H0407151A

* Bu sayfada ve katalogdaki tüm araçların adları, markaları, modelleri, sembolleri, logoları, orjinal numaraları (oe) ve diğer üçüncü parti numaraları sadece referans amaçlı kullanılmaktadır.

GOLF
III MK3, A3
1991 - 1998

Resim	Ürün Kodu ve Açıklaması	Detay	OEM
	AU11005 SALINCAK VE DENG KOLU BURCU ÖN ORTA SOL VE SAĞ B40115	Şasi (Ön / Arka) : ÖN Yön : Orta Sol Ve Sağ Ağırlık : 0,111 kg / 0.245 lb Not : VW6014 - VW60614J	191407182, 357407182 357407182F
	VW11001 SALINCAK VE DENG KOLU BURCU SOL VE SAĞ B40114	Yön : Sol Ve Sağ Ağırlık : 0.141 kg / 0.311 lb	191407181D, 191407181E 357407181
	VW11036 SALINCAK VE DENG KOLU BURCU SOL VE SAĞ	Yön : Sol Ve Sağ Ağırlık : 0.07 kg / 0.154 lb Not : BORUSU	191411315B, 4A0399413A
	VW11840 BURÇ	Yön : Sol Ve Sağ Ağırlık : 0,149 kg / 0.328 lb	357407181
	VW11069 Z-ROT BURCU ÖN	Şasi (Ön / Arka) : ÖN Ağırlık : 0,035 kg / 0.077 lb Z Rot 1 : VW4009	535411315
	VW12012 BEŞİK (TRAVERS) BURCU ARKA SOL VE SAĞ	Şasi (Ön / Arka) : ARKA Yön : Sol Ve Sağ Ağırlık : 0,63 kg / 1.389 lb	1H0501541A
	VW12012K BEŞİK (TRAVERS) BURCU ARKA SOL VE SAĞ	Şasi (Ön / Arka) : ARKA Yön : Sol Ve Sağ Ağırlık : 1,260 kg / 2.778 lb	1H0501541A
	VW12013 BEŞİK (TRAVERS) BURCU ARKA SOL VE SAĞ	Şasi (Ön / Arka) : ARKA Yön : Sol Ve Sağ Ağırlık : 1,380 kg / 3.042 lb	1H0501541A
	VW12056 BEŞİK (TRAVERS) BURCU ARKA SOL VE SAĞ	Şasi (Ön / Arka) : ARKA Yön : Sol Ve Sağ	1H9501541
	VW12056K BEŞİK (TRAVERS) BURCU ARKA SOL VE SAĞ	Şasi (Ön / Arka) : ARKA Yön : Sol Ve Sağ	1H9501541
	VW12053 VİRAJ DEMİR LASTİĞİ SOL VE SAĞ RUBBER	Şasi (Ön / Arka) : ÖN Yön : Sol Ve Sağ Ağırlık : 0.06 kg / 0.132 lb Malzeme Türü : Rubber Not : VİRAJ LASTİĞİ	1H0411314









* Bu sayfada ve katalogdaki tüm araçların adları, markaları, modelleri, sembolleri, logoları, orjinal numaraları (oe) ve diğer üçüncü parti numaraları sadece referans amaçlı kullanılmaktadır.

GOLF
III MK3, A3
1991 - 1998

Resim	Ürün Kodu ve Açıklaması	Detay	OEM
	VW12053K VİRAJ DEMİR LASTİĞİ SOL VE SAĞ RUBBER	Şasi (Ön / Arka) : ÖN Yön : Sol Ve Sağ Ağırlık : 0.12 kg / 0.265 lb Malzeme Türü : Rubber	1H0411314*
	VW12111 VİRAJ DEMİR LASTİĞİ SOL VE SAĞ RUBBER	Şasi (Ön / Arka) : ÖN Yön : Sol Ve Sağ Ağırlık : 0.015 kg / 0.033 lb Malzeme Türü : Rubber Not : VİRAJ LASTİĞİ	191411329, 6N0411329
	VW12111K VİRAJ DEMİR LASTİĞİ SOL VE SAĞ RUBBER	Şasi (Ön / Arka) : ÖN Yön : Sol Ve Sağ Ağırlık : 0.03 kg / 0.066 lb Malzeme Türü : Rubber	191411329*, 6N0411329*
	VW12001 AMORTİSÖR TAKOZU SOL VE SAĞ AMORTİSÖR TAKOZU	Yön : Sol Ve Sağ Ağırlık : 0.644 kg / 1.420 lb Not : AMORTİSÖR TAKOZU	176412329, 191412329 191412331
	VW12005 AMORTİSÖR TAKOZU SOL VE SAĞ AMORTİSÖR ÜST TAKOZU	Yön : Sol Ve Sağ Ağırlık : 0.1 kg / 0.220 lb Not : AMORTİSÖR ÜST TAKOZU	191512333
	VW12058 AMORTİSÖR TAKOZU SOL VE SAĞ	Yön : Sol Ve Sağ Ağırlık : 0.654 kg / 1.442 lb	357412329
	VW12065 AMORTİSÖR TAKOZU SOL VE SAĞ AMORTİSÖR KEPİ	Yön : Sol Ve Sağ Ağırlık : 0.377 kg / 0.831 lb Not : AMORTİSÖR KEPİ	191 512 113, 191512113
	VW12065K AMORTİSÖR TAKOZU ÖN SOL VE SAĞ 2 PCS	Şasi (Ön / Arka) : ÖN Yön : Sol Ve Sağ Ağırlık : 0.758 kg / 1.671 lb Not : 2 PCS	191512113
	VW12008 MOTOR TAKOZU SOL VE SAĞ MOTOR TAKOZU	Yön : Sol Ve Sağ Ağırlık : 0.574 kg / 1.265 lb Not : MOTOR TAKOZU	357199381C, 357199402B 3A0199402
	VW12074 MOTOR TAKOZU SOL VE SAĞ MOTOR TAKOZU	Yön : Sol Ve Sağ Ağırlık : 1.08 kg / 2.381 lb Not : MOTOR TAKOZU	1H0199609B, 1H0199609F 1H0199609G, 1H0199609J
	VW12092 MOTOR TAKOZU SAĞ MOTOR TAKOZU ARKA SAĞ	Yön : Sağ Ağırlık : 1.745 kg / 3.847 lb Not : MOTOR TAKOZU ARKA SAĞ	1H0199262B, 1H0199262G 1H0199262H

* Bu sayfada ve katalogdaki tüm araçların adları, markaları, modelleri, sembolleri, logoları, orjinal numaraları (oe) ve diğer üçüncü parti numaraları sadece referans amaçlı kullanılmaktadır.

GOLF
III MK3, A3
1991 - 1998

Resim	Ürün Kodu ve Açıklaması	Detay	OEM
	VW12098 MOTOR TAKOZU SOL VE SAĞ MOTOR TAKOZU	Yön : Sol Ve Sağ Ağırlık : 1,565 kg / 3.450 lb Not : MOTOR TAKOZU	1H0199262E
	VW12088 SÜSPANSİYON TAKOZU SOL VE SAĞ SÜSPANSİYON TAKOZU ARKA	Yön : Sol Ve Sağ Ağırlık : 0.11 kg / 0.243 lb Not : SÜSPANSİYON TAKOZU ARKA	191512131B
	VW12089 SÜSPANSİYON TAKOZU SOL VE SAĞ SÜSPANSİYON TAKOZU	Yön : Sol Ve Sağ Ağırlık : 0.15 kg / 0.331 lb Not : SÜSPANSİYON TAKOZU	191412303A, 357412303E
	VW12135 EGZOZ TAKOZU	Ağırlık : 0,155 kg / 0.342 lb	1H0253144, 1H0253144A 1H0253144C, 1H0253409C 6N0253144
	VW13008 DİREKSİYON KÖRÜĞÜ	Ağırlık : 0.225 kg / 0.496 lb	1H0422831B
	VW13010 DİREKSİYON KÖRÜĞÜ ÖN	Ağırlık : 0,124 kg / 0.273 lb	191422831
	AU14001 AKS KÖRÜĞÜ +KELEPÇE+YAĞ.	Ağırlık : 0.233 kg / 0.514 lb	6Q0498203A
	F114009 AKS KÖRÜĞÜ +KELEPÇE+YAĞ. DIŞ	Ağırlık : 0.207 kg / 0.456 lb	46307716
	OP14003 AKS KÖRÜĞÜ +KELEPÇE+YAĞ. AKS KÖRÜĞÜ DIŞ	Ağırlık : 0.2 kg / 0.441 lb	1603180
	OP14017 AKS KÖRÜĞÜ +KELEPÇE+YAĞ. DIŞ	Ağırlık : 0.17 kg / 0.375 lb	1603277
	RN14006 AKS KÖRÜĞÜ +KELEPÇE+YAĞ. DIŞ	Ağırlık : 0.2 kg / 0.441 lb	1603180, 1603204 16410170470106*, 16500170470106* 1H0498203, 271648 271649, 321498203A 431498203C, 443498203D

* Bu sayfada ve katalogdaki tüm araçların adları, markaları, modelleri, sembolleri, logoları, orjinal numaraları (oe) ve diğer üçüncü parti numaraları sadece referans amaçlı kullanılmaktadır.

GOLF III MK3, A3 1991 - 1998

Resim	Ürün Kodu ve Açıklaması	Detay	OEM
	VW14013 AKS KÖRÜĞÜ +KELEPÇE+YAĞ. YAĞ+KELEPÇE	Ağırlık : 0.156 kg / 0.344 lb	113501149, 171407283A
	VW14014 AKS KÖRÜĞÜ +KELEPÇE+YAĞ. YAĞ+KELEPÇE	Ağırlık : 0.28 kg / 0.617 lb	191498203C, 71498203

GOLF IV MK4, A4 1998 - 2003





Resim	Ürün Kodu ve Açıklaması	Detay	OEM
	AU1013 ROTİL ÖN ALT SAĞ - SOL Ø15,5 RB2535	Ağırlık : 0,555 kg / 1.224 lb Konik Ölçüsü : Ø15,5 Bağlantı Delik Çapı : Ø10,7 Aşık Dış Çapı : M12X1,5	8N0.407.365A, 8N0.407.365B 8N0.407.365C, 8N0407365A 8N0407365B, 8N0407365C
	AU1014 ROTİL ALT SAĞ Ø15	Ağırlık : 0,35 kg / 0.772 lb Konik Ölçüsü : Ø15 Bağlantı Delik Çapı : Ø8,5 Aşık Dış Çapı : M12X1,25	1J0407366A, 1J0407366AS 1J0407366B, 1J0407366C 1J0407366D, 1J0407366H
	AU1014K ROTİL ÖN SAĞ Ø15 RB2530	Ağırlık : 0,5 kg / 1.102 lb Konik Ölçüsü : Ø15 Bağlantı Delik Çapı : Ø8,5 Aşık Dış Çapı : M12X1,25	1J0407366, 1J0407366A 1J0407366AS, 1J0407366B 1J0407366C, 1J0407366CS 1J0407366D*, 1J0407366D 1J0407366H, 8Z0407366A
	AU1015 ROTİL SOL	Ağırlık : 0,35 kg / 0.772 lb Konik Ölçüsü : Ø15 Bağlantı Delik Çapı : Ø8,5 Aşık Dış Çapı : M12X1,25	1J0407365A, 1J0407365B 1J0407365C, 1J0407365D
	AU1015K ROTİL ÖN SOL Ø15 RB2529	Ağırlık : 0,5 kg / 1.102 lb Konik Ölçüsü : Ø15 Bağlantı Delik Çapı : Ø8,5 Aşık Dış Çapı : M12X1,25	1J0407365, 1J0407365A* 1J0407365A, 1J0407365AS 1J0407365B*, 1J0407365B 1J0407365C*, 1J0407365C 1J0407365CS, 1J0407365D*
	AU2009 ROTBAŞI SAĞ UZUN RD0332	Ağırlık : 0,37 kg / 0.816 lb Uzunluk : 92 mm / 3.62 inch Gövde Dış Çapı : M14X1,5 Aşık Dış Çapı : M12X1,5 Aşık Konik Çapı : Ø13,3	1J0422812B, 3A0422812B 6R0423812A
	AU2010 ROTBAŞI SOL RD0331	Ağırlık : 0,375 kg / 0.827 lb Uzunluk : 92 mm / 3.62 inch Gövde Dış Çapı : M14X1,5 Aşık Dış Çapı : M12X1,5 Aşık Konik Çapı : Ø13,2	1J0422811B, 1JD422811 3A0422811B, 6R0423811A
	AU2318 ROTBAŞI SOL KISA RB2318	Ağırlık : 0,312 kg / 0.688 lb Uzunluk : 76 mm / 2.99 inch Gövde Dış Çapı : M14X1,5 Aşık Dış Çapı : M12X1,5 Aşık Konik Çapı : Ø13,4	1J0422811, 1J0422811A

* Bu sayfada ve katalogdaki tüm araçların adları, markaları, modelleri, sembolleri, logoları, orjinal numaraları (oe) ve diğer üçüncü parti numaraları sadece referans amaçlı kullanılmaktadır.

GOLF

IV MK4, A4

1998 - 2003

Resim	Ürün Kodu ve Açıklaması	Detay	OEM
	AU2319 ROTBAŞI SAĞ KISA RB2319	Ağırlık : 0,315 kg / 0.694 lb Uzunluk : 76 mm / 2.99 inch Gövde Diş Çapı : M14X1,5 Aşık Diş Çapı : M12X1,5 Aşık Konik Çapı : Ø13,4	1J0422812, 1J0422812A
	AU3001 ROTMİLİ SOL VE SAĞ 318 RD0908	Ağırlık : 0,622 kg / 1.371 lb Uzunluk : 318 mm / 12.52 inch Gövde Diş Çapı : M16X1,5 Aşık Diş Çapı : M14X1,5	1J0422803B, 1J0422804B 1J0422804E, 1J0422807 1J0422807B, 1J0422821B
	AU3003 ROTMİLİ SAĞ-SOL UZUN L 360 MM RB2811	Ağırlık : 0,629 kg / 1.387 lb Uzunluk : 341 mm / 13.43 inch Gövde Diş Çapı : M16X1,5 Aşık Diş Çapı : M14X1,5	1J0422803A, 1J0422804A 1J0422807A, 1J0422807C 1J0422821, 1J0422821A 1J0822807B
	AU3004 ROTMİLİ	Ağırlık : 0.35 kg / 0.772 lb Uzunluk : 320 mm / 12.60 inch	1J0422810B

VW8001 / Süspansiyon Kit Ön
GOLF
IV MK4, A4
1998 - 2003

Kit Parçaları

Resim	Ürün Kodu / Adı	OEM	OEM	Ürün Kodu / Adı	Resim
	AU2009 Rotbaşı Sağ Uzun Rd0332	1J0422812B, 3A0422812B 6R0423812A	1J0422811B, 1JD422811 3A0422811B, 6R0423811A	AU2010 Rotbaşı Sol Rd0331	
	AU3001 Rotmili Sol Ve Sağ 318 Rd0908	1J0422803B, 1J0422804B 1J0422804E, 1J0422807 1J0422807B, 1J0422821B	1J0411315E, 1J0411315G 1J0422315G	VW4011 Z Rot Ön Sağ-sol Metal 105 Rd0916	
	AU6008 Salıncak Ön Sağ Rb3011	1J0407151B	1J0407151A	AU6009 Salıncak Ön Sol Rb3012	

VW8003 / Süspansiyon Kit Ön

GOLF

IV MK4, A4











1998 - 2003



Kit Parçaları

Resim	Ürün Kodu / Adı	OEM	OEM	Ürün Kodu / Adı	Resim
	AU1014 Rotil Alt Sağ Ø15	1J0407366A, 1J0407366AS 1J0407366B, 1J0407366C 1J0407366D, 1J0407366H	1J0407365A, 1J0407365B 1J0407365C, 1J0407365D	AU1015 Rotil Sol	
	AU11002 Salıncak Ve Denge Kolu Burcu Ön Sol Ve Sağ B22117	1J0407181, 1J0407181A	191407182, 357407182 357407182F	AU11005 Salıncak Ve Denge Kolu Burcu Ön Orta Sol Ve Sağ B40115	
	VW4011 Z Rot Ön Sağ-sol Metal 105 Rd0916	1J0411315E, 1J0411315G 1J0422315G			

GOLF
IV MK4, A4
1998 - 2003

Resim	Ürün Kodu ve Açıklaması	Detay	OEM
	AU20093001 ROT TAKIMI SAĞ	Ağırlık : 0,951 kg / 2.097 lb Rotbaşı : AU2009 Rotmili : AU3001	1H0422804B
	AU20093004 ROT TAKIMI SAĞ KOMPLE	Ağırlık : 1.1 kg / 2.425 lb Rotbaşı : AU2009 Rotmili : AU3004	1J0422804B, 1J0422804C
	AU20103001 ROT TAKIMI SOL	Ağırlık : 0,952 kg / 2.099 lb Rotbaşı : AU2010 Rotmili : AU3001	1H0422803B
	AU20103004 ROT TAKIMI SOL KOMPLE	Ağırlık : 1.1 kg / 2.425 lb Rotbaşı : AU2010 Rotmili : AU3004	1J0422803B, 1J0422803C
	AU23183003 ROT TAKIMI SAĞ RB288113	Ağırlık : 0,945 kg / 2.083 lb Rotbaşı : AU2318 Rotmili : AU3003	1J0422804, 1J0422804A 1J0422804C
	AU23183004 ROT TAKIMI SOL RD088206	Ağırlık : 1.075 kg / 2.370 lb Rotbaşı : AU2318 Rotmili : AU3004	1J0422803B
	AU23193003 ROT TAKIMI SOL RB288112	Ağırlık : 0,94 kg / 2.072 lb Rotbaşı : AU2319 Rotmili : AU3003	1J0422803, 1J0422803A 1J0422803C
	AU23193004 ROT TAKIMI SAĞ RD088207	Ağırlık : 1.1 kg / 2.425 lb Rotbaşı : AU2319 Rotmili : AU3004	1J0422804B
	AU4005 Z ROT ÖN SOL METAL RB2924	Ağırlık : 0,602 kg / 1.327 lb Malzeme Türü : Metal Uzunluk : 335 mm / 13.19 inch Aşık Diş Çapı : M12X1,5	1J0411315D, 1J0411615D
	AU4006 Z ROT ÖN SAĞ METAL RB2923	Ağırlık : 0,282 kg / 0.622 lb Malzeme Türü : Metal Uzunluk : 335 mm / 13.19 inch Aşık Diş Çapı : M12X1,5	1J0411316D
	AU4021 Z ROT SOL VE SAĞ METAL RB2940	Ağırlık : 0,26 kg / 0.573 lb Malzeme Türü : Metal Uzunluk : 175 mm / 6.89 inch Aşık Diş Çapı : M10X1,5	1J0505466, 1J0505466B 1J0505466C







* Bu sayfada ve katalogdaki tüm araçların adları, markaları, modelleri, sembolleri, logoları, orijinal numaraları (oe) ve diğer üçüncü parti numaraları sadece referans amaçlı kullanılmaktadır.

GOLF
IV MK4, A4
1998 - 2003

Resim	Ürün Kodu ve Açıklaması	Detay	OEM
	VW4010 Z ROT SOL VE SAĞ PLASTİK RD0924	Ağırlık : 0,18 kg / 0.397 lb Malzeme Türü : Plastik Uzunluk : 106 mm / 4.17 inch Aşık Diş Çapı : M10X1,5	1J0411315C, 1J0411315J
	VW4011 Z ROT ÖN SAĞ-SOL METAL 105 RD0916	Ağırlık : 0,258 kg / 0.569 lb Malzeme Türü : Metal Uzunluk : 106 mm / 4.17 inch Aşık Diş Çapı : M10X1,5	1J0411315E, 1J0411315G 1J0422315G
	VW4012 Z ROT ÖN SAĞ METAL RD0937	Ağırlık : 0,437 kg / 0.963 lb Malzeme Türü : Metal Uzunluk : 340 mm / 13.39 inch Aşık Diş Çapı : M12X1,5	68510018
	VW4013 Z ROT ÖN SOL METAL 340 RD0938	Ağırlık : 0,437 kg / 0.963 lb Malzeme Türü : Metal Uzunluk : 340 mm / 13.39 inch Aşık Diş Çapı : M12X1,5	68510017
	VW4020 Z ROT ÖN SAĞ-SOL PLASTİK 105,5	Ağırlık : 0,151 kg / 0.333 lb Malzeme Türü : Plastik Uzunluk : 105 mm / 4.13 inch	1J0411315B, 1J0411315H 1J0411315K
	AU6008 SALINCAK ÖN SAĞ RB3011	Ağırlık : 3,495 kg / 7.705 lb Malzeme Türü : Sac Metal	1J0407151B
	AU6008J SALINCAK ÖN SAĞ RB3101	Ağırlık : 3,212 kg / 7.081 lb Malzeme Türü : Sac Metal	1J0407151C
	AU6009 SALINCAK ÖN SOL RB3012	Ağırlık : 3,495 kg / 7.705 lb Malzeme Türü : Sac Metal	1J0407151A
	SE9003 SALINCAK ALT VE ÜST SOL VE SAĞ	Ağırlık : 1,080 kg / 2.381 lb Malzeme Türü : Sac Metal	1J0505323H, 1J0505323J 1J0505323L, 1J0505323M 1J0505323N
	AU11002 SALINCAK VE DENGİ KOLU BURCU ÖN SOL VE SAĞ B22117	Şasi (Ön / Arka) : ÖN Yön : Sol Ve Sağ Ağırlık : 0,108 kg / 0.238 lb	1J0407181, 1J0407181A
	AU11005 SALINCAK VE DENGİ KOLU BURCU ÖN ORTA SOL VE SAĞ B40115	Şasi (Ön / Arka) : ÖN Yön : Orta Sol Ve Sağ Ağırlık : 0,111 kg / 0.245 lb Not : VW6014 - VW60614J	191407182, 357407182 357407182F

* Bu sayfada ve katalogdaki tüm araçların adları, markaları, modelleri, sembolleri, logoları, orjinal numaraları (oe) ve diğer üçüncü parti numaraları sadece referans amaçlı kullanılmaktadır.

GOLF
IV MK4, A4
1998 - 2003

Resim	Ürün Kodu ve Açıklaması	Detay	OEM
	VW11036 SALINCAK VE DENGE KOLU BURCU SOL VE SAĞ	Yön : Sol Ve Sağ Ağırlık : 0.07 kg / 0.154 lb Not : BORUSU	191411315B, 4A0399413A
	AU11023 Z-ROT BURCU ARKA	Şasi (Ön / Arka) : ARKA Ağırlık : 0.26 kg / 0.573 lb Uzunluk : AU4021 mm / 0.00 inch Aşık Diş Çapı : VW4017	1J0505466B*
	VW11090 Z-ROT BURCU ÖN	Şasi (Ön / Arka) : ÖN Ağırlık : 0,045 kg / 0.099 lb	1J0411315*, 1J0411315B* 1J0411315C*, 1J0411315E* 1J0411315G*, 1J0411315J*
	VW12012 BEŞİK (TRAVERS) BURCU ARKA SOL VE SAĞ	Şasi (Ön / Arka) : ARKA Yön : Sol Ve Sağ Ağırlık : 0,63 kg / 1.389 lb	1H0501541A
	VW12012K BEŞİK (TRAVERS) BURCU ARKA SOL VE SAĞ	Şasi (Ön / Arka) : ARKA Yön : Sol Ve Sağ Ağırlık : 1,260 kg / 2.778 lb	1H0501541A
	VW12013 BEŞİK (TRAVERS) BURCU ARKA SOL VE SAĞ	Şasi (Ön / Arka) : ARKA Yön : Sol Ve Sağ Ağırlık : 1,380 kg / 3.042 lb	1H0501541A
	VW12056 BEŞİK (TRAVERS) BURCU ARKA SOL VE SAĞ	Şasi (Ön / Arka) : ARKA Yön : Sol Ve Sağ	1H9501541
	VW12056K BEŞİK (TRAVERS) BURCU ARKA SOL VE SAĞ	Şasi (Ön / Arka) : ARKA Yön : Sol Ve Sağ	1H9501541
	VW11008 TAŞIYICI DESTEK BURÇLARI SOL VE SAĞ	Yön : Sol Ve Sağ Ağırlık : 0.24 kg / 0.529 lb	1J0505203, 1J0505365D 1J0505365F, 1J0505365G 1J0505365J, 1J0505365K 1J0505365M, 1J0505365N
	VW12010 TORSİYON BURCU SOL VE SAĞ	Yön : Sol Ve Sağ Ağırlık : 0.31 kg / 0.683 lb	1J0500045, 1J0500045A 1J0501541B, 1J0501541C 6R0501541A, 6R0501541B
	VW12066 TORSİYON BURCU SOL VE SAĞ	Yön : Sol Ve Sağ Ağırlık : 0.6 kg / 1.323 lb	1J0 501 541 D, 1J0501541D



* Bu sayfada ve katalogdaki tüm araçların adları, markaları, modelleri, sembolleri, logoları, orjinal numaraları (oe) ve diğer üçüncü parti numaraları sadece referans amaçlı kullanılmaktadır.

GOLF
IV MK4, A4
1998 - 2003

Resim	Ürün Kodu ve Açıklaması	Detay	OEM
	VW12016 VİRAJ DEMİR LASTİĞİ SOL VE SAĞ RUBBER	Şasi (Ön / Arka) : ÖN Yön : Sol Ve Sağ Ağırlık : 0.03 kg / 0.066 lb Malzeme Türü : Rubber	1J0411314G, 1J0411314T 8N0411303G, 8N0411303H
	VW12016K VİRAJ DEMİR LASTİĞİ SOL VE SAĞ RUBBER	Şasi (Ön / Arka) : ÖN Yön : Sol Ve Sağ Ağırlık : 0.06 kg / 0.132 lb Malzeme Türü : Rubber Not : İKLİ	1J0411314G, 1J0411314T 8N0411303G, 8N0411303H
	VW12020 VİRAJ DEMİR LASTİĞİ SOL VE SAĞ RUBBER	Şasi (Ön / Arka) : ÖN Yön : Sol Ve Sağ Ağırlık : 0.07 kg / 0.154 lb Malzeme Türü : Rubber Not : VİRAJ ORTA LASTİĞİ	8D0511327C
	VW12020K VİRAJ DEMİR LASTİĞİ SOL VE SAĞ RUBBER	Şasi (Ön / Arka) : ÖN Yön : Sol Ve Sağ Ağırlık : 0.14 kg / 0.309 lb Malzeme Türü : Rubber	8D0511327C*
	VW12047 VİRAJ DEMİR LASTİĞİ SOL VE SAĞ RUBBER	Şasi (Ön / Arka) : ÖN Yön : Sol Ve Sağ Ağırlık : 0.14 kg / 0.309 lb Malzeme Türü : Rubber Not : VİRAJ LASTİĞİ	1J0411314B, 1J0411314S
	VW12047K VİRAJ DEMİR LASTİĞİ SOL VE SAĞ RUBBER	Şasi (Ön / Arka) : ÖN Yön : Sol Ve Sağ Ağırlık : 0.28 kg / 0.617 lb Malzeme Türü : Rubber Not : VİRAJ LASTİĞİ (2 ADET)	1J0411314B*, 1J0411314B 1J0411314S*, 1J0411314S
	VW12048 VİRAJ DEMİR LASTİĞİ SOL VE SAĞ RUBBER	Şasi (Ön / Arka) : ÖN Yön : Sol Ve Sağ Ağırlık : 0.03 kg / 0.066 lb Malzeme Türü : Rubber Not : VİRAJ LASTİĞİ	1J0411314P
	VW12048K VİRAJ DEMİR LASTİĞİ SOL VE SAĞ RUBBER	Şasi (Ön / Arka) : ÖN Yön : Sol Ve Sağ Ağırlık : 0.06 kg / 0.132 lb Malzeme Türü : Rubber	1J0411314P*
	VW12052 VİRAJ DEMİR LASTİĞİ SOL VE SAĞ RUBBER	Şasi (Ön / Arka) : ÖN Yön : Sol Ve Sağ Ağırlık : 0.06 kg / 0.132 lb Malzeme Türü : Rubber Not : VİRAJ LASTİĞİ	1J0411314R
	VW12052K VİRAJ DEMİR LASTİĞİ SOL VE SAĞ RUBBER	Şasi (Ön / Arka) : ÖN Yön : Sol Ve Sağ Ağırlık : 0.12 kg / 0.265 lb Malzeme Türü : Rubber	1J0411314R*
	VW12064 VİRAJ DEMİR LASTİĞİ SOL VE SAĞ RUBBER	Şasi (Ön / Arka) : ÖN Yön : Sol Ve Sağ Ağırlık : 0,023 kg / 0.051 lb Malzeme Türü : Rubber Not : D=Ø21mm	1J0411314C, 1J0411314R

* Bu sayfada ve katalogdaki tüm araçların adları, markaları, modelleri, sembolleri, logoları, orjinal numaraları (oe) ve diğer üçüncü parti numaraları sadece referans amaçlı kullanılmaktadır.

GOLF
IV MK4, A4
1998 - 2003

Resim	Ürün Kodu ve Açıklaması	Detay	OEM
	VW12064K VİRAJ DEMİR LASTİĞİ SOL VE SAĞ RUBBER	Şasi (Ön / Arka) : ÖN Yön : Sol Ve Sağ Ağırlık : 0.046 kg / 0.101 lb Malzeme Türü : Rubber	1J0411314C*
	VW12117 VİRAJ DEMİR LASTİĞİ SOL VE SAĞ RUBBER	Şasi (Ön / Arka) : ÖN Yön : Sol Ve Sağ Ağırlık : 0.08 kg / 0.176 lb Malzeme Türü : Rubber	1J0411327
	VW12117K VİRAJ DEMİR LASTİĞİ SOL VE SAĞ RUBBER	Şasi (Ön / Arka) : ÖN Yön : Sol Ve Sağ Ağırlık : 0.16 kg / 0.353 lb Malzeme Türü : Rubber	1J0411327
	SK12002 AMORTİSÖR TAKOZU ARKA SOL VE SAĞ 1.2 / 1.4TSI / 1.6TDI / 1.2TDI	Şasi (Ön / Arka) : ARKA Yön : Sol Ve Sağ Ağırlık : 0.305 kg / 0.672 lb Not : 1.2 / 1.4TSI / 1.6TDI / 1.2TDI	1J0513353A, 1J0513353B 1J0513353C, 1J0513353G 6QE513353, 6R0513353 6R0513353B
	VW12061 AMORTİSÖR TAKOZU SOL VE SAĞ AMORTİSÖR TAKOZU	Yön : Sol Ve Sağ Ağırlık : 0.27 kg / 0.595 lb Not : AMORTİSÖR TAKOZU	1H0412365A, 1J0412249 1J0412331BS, 1J0412331C
	VW12061A AMORTİSÖR TAKOZU SOL VE SAĞ AMORTİSOR RULMANI	Yön : Sol Ve Sağ Ağırlık : 0.08 kg / 0.176 lb Not : AMORTİSOR RULMANI	1J0412249, 1J0412249C 357412249, 357412249A 4503300051, 7201688 7201848, 95VW3K031AA
	VW12061K AMORTİSÖR TAKOZU SOL VE SAĞ 2 PCS	Yön : Sol Ve Sağ Ağırlık : 0.7 kg / 1.543 lb Not : 2 PCS	1H0412365A, 1J0412249 1J0412331BS, 1J0412331C
	VW12065 AMORTİSÖR TAKOZU SOL VE SAĞ AMORTİSÖR KEPİ	Yön : Sol Ve Sağ Ağırlık : 0.377 kg / 0.831 lb Not : AMORTİSÖR KEPİ	191 512 113, 191512113
	VW12065K AMORTİSÖR TAKOZU ÖN SOL VE SAĞ 2 PCS	Şasi (Ön / Arka) : ÖN Yön : Sol Ve Sağ Ağırlık : 0.758 kg / 1.671 lb Not : 2 PCS	191512113
	VW12103 AMORTİSÖR TAKOZU SOL VE SAĞ AMORTİSÖR ÜST TAKOZU	Yön : Sol Ve Sağ Ağırlık : 0.23 kg / 0.507 lb Not : AMORTİSÖR ÜST TAKOZU	1J0412331B, 1J0412331C
	VW12030 MOTOR TAKOZU SOL VE SAĞ MOTOR TAKOZU ARKA	Yön : Sol Ve Sağ Ağırlık : 1.15 kg / 2.535 lb Not : MOTOR TAKOZU ARKA	1J0199851, 1J0199851AK

* Bu sayfada ve katalogdaki tüm araçların adları, markaları, modelleri, sembolleri, logoları, orjinal numaraları (oe) ve diğer üçüncü parti numaraları sadece referans amaçlı kullanılmaktadır.

GOLF
IV MK4, A4
1998 - 2003

Resim	Ürün Kodu ve Açıklaması	Detay	OEM
	VW12040 MOTOR TAKOZU SOL VE SAĞ MOTOR TAKOZU	Yön : Sol Ve Sağ Ağırlık : 1.641 kg / 3.618 lb Not : MOTOR TAKOZU	1J0199555AA, 1J0199555AK
	VW12070 MOTOR TAKOZU SOL VE SAĞ MOTOR TAKOZU	Yön : Sol Ve Sağ Ağırlık : 1.64 kg / 3.616 lb Not : MOTOR TAKOZU	1J0199555AH
	VW12075 MOTOR TAKOZU SOL VE SAĞ MOTOR TAKOZU	Yön : Sol Ve Sağ Ağırlık : 2.2 kg / 4.850 lb Not : MOTOR TAKOZU	1J0199262BF
	VW12081 MOTOR TAKOZU SOL VE SAĞ MOTOR TAKOZU	Yön : Sol Ve Sağ Ağırlık : 2.04 kg / 4.497 lb Not : MOTOR TAKOZU	1J0199262BK
	VW12084 MOTOR TAKOZU SOL VE SAĞ MOTOR TAKOZU	Yön : Sol Ve Sağ Ağırlık : 2.034 kg / 4.484 lb Not : MOTOR TAKOZU	1J0199262BE
	VW12085 MOTOR TAKOZU SOL VE SAĞ EGZOS TAKOZU	Yön : Sol Ve Sağ Ağırlık : 0.1 kg / 0.220 lb Not : EGZOS TAKOZU	1J0253144G, 1J0802117
	VW12092 MOTOR TAKOZU SAĞ MOTOR TAKOZU ARKA SAĞ	Yön : Sağ Ağırlık : 1,745 kg / 3.847 lb Not : MOTOR TAKOZU ARKA SAĞ	1H0199262B, 1H0199262G 1H0199262H
	VW12100 MOTOR TAKOZU SOL VE SAĞ MOTOR TAKOZU ARKA	Yön : Sol Ve Sağ Ağırlık : 1.12 kg / 2.469 lb Not : MOTOR TAKOZU ARKA	1J0199851AA, 1J0199851AK 1J0199851M, 1J0199851N
	VW12102 MOTOR TAKOZU SOL VE SAĞ MOTOR TAKOZU	Yön : Sol Ve Sağ Ağırlık : 1.64 kg / 3.616 lb Not : MOTOR TAKOZU	1J0199555AJ, 1J0199555AM 1J0199555AQ, 1J0199555BH
	VW12096 SÜSPANSİYON TAKOZU SOL VE SAĞ SÜSPANSİYON TAKOZU	Yön : Sol Ve Sağ Ağırlık : 0.035 kg / 0.077 lb Not : SÜSPANSİYON TAKOZU	1J0412303
	VW12135 EGZOZ TAKOZU	Ağırlık : 0,155 kg / 0.342 lb	1H0253144, 1H0253144A 1H0253144C, 1H0253409C 6N0253144

* Bu sayfada ve katalogdaki tüm araçların adları, markaları, modelleri, sembolleri, logoları, orjinal numaraları (oe) ve diğer üçüncü parti numaraları sadece referans amaçlı kullanılmaktadır.

GOLF
IV MK4, A4
1998 - 2003

Resim	Ürün Kodu ve Açıklaması	Detay	OEM
	VW13002 RIW DİREKSİYON KÖRÜĞÜ	Ağırlık : 0.1 kg / 0.220 lb	1J0422831, 1J0422831B 8N0422831
	VW13002K DİREKSİYON KÖRÜĞÜ SOL VE SAĞ 2 PİECES	Ağırlık : 0.2 kg / 0.441 lb	1J0422831, 1J0422831B 8N0422831
	VW13008 DİREKSİYON KÖRÜĞÜ	Ağırlık : 0.225 kg / 0.496 lb	1H0422831B
	VW13010 DİREKSİYON KÖRÜĞÜ ÖN	Ağırlık : 0,124 kg / 0.273 lb	191422831
	F114014 AKS KÖRÜĞÜ +KELEPÇE+YAĞ. DIŞ	Ağırlık : 0.211 kg / 0.465 lb	46307841
	RN14006 AKS KÖRÜĞÜ +KELEPÇE+YAĞ. DIŞ	Ağırlık : 0.2 kg / 0.441 lb	1603180, 1603204 16410170470106*, 16500170470106* 1H0498203, 271648 271649, 321498203A 431498203C, 443498203D
	VW14003 AKS KÖRÜĞÜ +KELEPÇE+YAĞ. DIŞ	Ağırlık : 0.25 kg / 0.551 lb	1K0 498 203, 1K0498203
	VW15002 AMORTİSÖR KÖRÜĞÜ ARKA	Şasi (Ön / Arka) : ARKA	900064

GOLF
V MK5, A5
2003 - 2009

Resim	Ürün Kodu ve Açıklaması	Detay	OEM
	VW1014 ROTİL ÖN ALT SAĞ Ø15,6 RB2536	Ağırlık : 0,565 kg / 1.246 lb Konik Ölçüsü : Ø15,6 Bağlantı Delik Çapı : Ø10,5 Aşık Diş Çapı : M12X1,5	1K0407366B, 1K0407366C 1K0407366E, 5Q0407366A
	VW1015 ROTİL ÖN ALT SOL Ø15,6 RB2537	Ağırlık : 0,565 kg / 1.246 lb Konik Ölçüsü : Ø15,6 Bağlantı Delik Çapı : Ø10,5 Aşık Diş Çapı : M12X1,5	1K0407365B, 1K0407365C 1K0407365E, 5Q0407365A











* Bu sayfada ve katalogdaki tüm araçların adları, markaları, modelleri, sembolleri, logoları, orjinal numaraları (oe) ve diğer üçüncü parti numaraları sadece referans amaçlı kullanılmaktadır.

GOLF
V MK5, A5
2003 - 2009

Resim	Ürün Kodu ve Açıklaması	Detay	OEM
	VW2008 ROTBAŞI ÖN SAĞ RD0342	Ağırlık : 0,412 kg / 0.908 lb Uzunluk : 95 mm / 3.74 inch Gövde Diş Çapı : M16X1,5 Aşık Diş Çapı : M12X1,5 Aşık Konik Çapı : Ø12,7	1K0423812A, 1K0423812C 1K0423812E, 1K0423812G 1K0423812J, 1K0423812K 1KD423812A
	VW2009 ROTBAŞI ÖN SOL RD0343	Ağırlık : 0,412 kg / 0.908 lb Uzunluk : 95 mm / 3.74 inch Gövde Diş Çapı : M16X1,5 Aşık Diş Çapı : M12X1,5 Aşık Konik Çapı : Ø13,5	1K0423811A, 1K0423811C 1K0423811E, 1K0423811G 1K0423811J, 1K0423811K 1KD423811A
	VW3009 ROTMİLİ SAĞ-SOL 310 RB2838	Ağırlık : 0,665 kg / 1.466 lb Uzunluk : 311 mm / 12.24 inch Gövde Diş Çapı : M16X1,5 Aşık Diş Çapı : M16X1,5	1K0423810A
	VW20083009 ROT TAKIMI ÖN AKS SAĞ RB288137	Ağırlık : 1,078 kg / 2.377 lb Rotbaşı : VW2008 Rotmilî : VW3009	
	VW20093009 ROT TAKIMI ÖN SOL RB288138	Ağırlık : 1,077 kg / 2.374 lb Rotbaşı : VW2009 Rotmilî : VW3009	
	SK4005 Z ROT ÖM SAĞ-SOL L=335MM	Ağırlık : 0,322 kg / 0.710 lb Malzeme Türü : Metal Uzunluk : 335 mm / 13.19 inch Aşık Diş Çapı : M12X1,5	5Q0411315B
	VW4014 Z ROT ÖN SAĞ-SOL METAL 335 RB2935	Ağırlık : 0,46 kg / 1.014 lb Malzeme Türü : Metal Uzunluk : 335 mm / 13.19 inch Aşık Diş Çapı : M12X1,5	1K0411315B, 1K0411315D 1K0411315J, 1K0411315K 1K0411315R, 5Q0411315A 5Q0411315B
	VW4015 Z ROT SOL VE SAĞ METAL RB2937	Ağırlık : 0,373 kg / 0.822 lb Malzeme Türü : Metal Uzunluk : 95,5 mm / 3.76 inch Aşık Diş Çapı : M10X1,5	1K0505465C, 1K0505465D 1K0505465H, 1K0505465J 1K0505465K
	VW4015K Z ROT SOL VE SAĞ METAL	Ağırlık : 0,373 kg / 0.822 lb Malzeme Türü : Metal Uzunluk : 95,5 mm / 3.76 inch Aşık Diş Çapı : M10X1,5	1K0505465C, 1K0505465D 1K0505465H, 1K0505465J 1K0505465K
	VW4016 Z ROT ARKA METAL 243 RD0945	Ağırlık : 0,384 kg / 0.847 lb Malzeme Türü : Metal Uzunluk : 241 mm / 9.49 inch Aşık Diş Çapı : M12X1,5	2K0505465B, 2K0505465C 2K0505465E
	AU6010 SALINCAK ÜST SOL VE SAĞ RA5155	Ağırlık : 1,298 kg / 2.862 lb Malzeme Türü : Sac Metal	1K0505323H, 1K0505323N



* Bu sayfada ve katalogdaki tüm araçların adları, markaları, modelleri, sembolleri, logoları, orjinal numaraları (oe) ve diğer üçüncü parti numaraları sadece referans amaçlı kullanılmaktadır.

GOLF
V MK5, A5
2003 - 2009

Resim	Ürün Kodu ve Açıklaması	Detay	OEM
	SE9001 SALINCAK ALT SAĞ RA5150	Ağırlık : 1 kg / 2.205 lb Malzeme Türü : Sac Metal	1K0501530C
	SE9002 SALINCAK ALT SOL RA5151	Ağırlık : 1 kg / 2.205 lb Malzeme Türü : Sac Metal	1K0501529F
	SK9001 SALINCAK ARKA ALT	Ağırlık : 0,701 kg / 1.545 lb Malzeme Türü : Sac Metal	1K0501529J
	VW6016 SALINCAK ÖN SAĞ RD10227	Ağırlık : 4,543 kg / 10.016 lb Malzeme Türü : Sac Metal	1K0407152P, 1K0407152Q* 1K0407152Q
	VW6016J SALINCAK ÖN ALT SAĞ S737	Ağırlık : 4,015 kg / 8.852 lb Malzeme Türü : Sac Metal	1K0407151P, 1K0407151Q 1K0407152P, 1K0407152Q
	VW6017 SALINCAK ÖN SOL RD10226	Ağırlık : 4,543 kg / 10.016 lb Malzeme Türü : Sac Metal	1K0407151M*, 1K0407151P 1K0407151Q*, 1K0407151Q
	VW6017J SALINCAK ÖN ALT SOL S738	Ağırlık : 4,015 kg / 8.852 lb Malzeme Türü : Sac Metal	1K0407151P, 1K0407151Q 1K0407152P, 1K0407152Q
	VW6018J SALINCAK ÖN SAĞ RB30211	Ağırlık : 4,232 kg / 9.330 lb Malzeme Türü : Döküm Çelik	1K0407152AC, 1K0407152M 1K0407152R
	VW6019J SALINCAK ÖN SOL RB30212	Ağırlık : 4,232 kg / 9.330 lb Malzeme Türü : Döküm Çelik	1K0407151AC, 1K0407151M 1K0407151R
	AU11014 SALINCAK VE DENGE KOLU BURCU ARKA SOL VE SAĞ	Şasi (Ön / Arka) : ARKA Yön : Sol Ve Sağ Ağırlık : 0.192 kg / 0.423 lb	1K0505543A
	AU11052 SALINCAK VE DENGE KOLU BURCU SOL VE SAĞ	Yön : Sol Ve Sağ Ağırlık : 0,178 kg / 0.392 lb	1K0505541B, 1K0505541C 1K0505541D

* Bu sayfada ve katalogdaki tüm araçların adları, markaları, modelleri, sembolleri, logoları, orijinal numaraları (oe) ve diğer üçüncü parti numaraları sadece referans amaçlı kullanılmaktadır.

GOLF
V MK5, A5
2003 - 2009

Resim	Ürün Kodu ve Açıklaması	Detay	OEM
	SK11009 SALINCAK VE DENGE KOLU BURCU ARKA SOL VE SAĞ	Şasi (Ön / Arka) : ARKA Yön : Sol Ve Sağ Ağırlık : 0,176 kg / 0.388 lb	1K0501529J*
	SK11010 SALINCAK VE DENGE KOLU BURCU ARKA SOL VE SAĞ	Şasi (Ön / Arka) : ARKA Yön : Sol Ve Sağ Ağırlık : 0,196 kg / 0.432 lb Not : BÜYÜK	1K0501529J*
	VW11037 SALINCAK VE DENGE KOLU BURCU SOL VE SAĞ	Yön : Sol Ve Sağ Ağırlık : 0.11 kg / 0.243 lb	1K0505279A
	VW11042 SALINCAK VE DENGE KOLU BURCU ORTA SOL VE SAĞ	Yön : Orta Sol Ve Sağ Ağırlık : 0,182 kg / 0.401 lb	1K0407182, 5Q0407182
	VW11043 SALINCAK VE DENGE KOLU BURCU SAĞ B22141	Yön : Sağ Diğer Taraf : VW11044 Ağırlık : 0,659 kg / 1.453 lb	1K0199232G, 1K0199232H 1K0199232J
	VW11043B SALINCAK VE DENGE KOLU BURCU SAĞ	Yön : Sağ Diğer Taraf : VW11044B Ağırlık : 0,659 kg / 1.453 lb Not : İÇ BURÇSUZ	1K0199232G, 1K0199232H 1K0199232J
	VW11044 SALINCAK VE DENGE KOLU BURCU SOL B22142	Yön : Sol Diğer Taraf : VW11043 Ağırlık : 0,678 kg / 1.495 lb	1K0199231G, 1K0199231H 1K0199231J
	VW11044B SALINCAK VE DENGE KOLU BURCU SOL	Yön : Sol Diğer Taraf : VW11043B Ağırlık : 0,678 kg / 1.495 lb Not : İÇ BURÇSUZ	1K0199231G, 1K0199231H 1K0199231J
	VW11047 SALINCAK VE DENGE KOLU BURCU İÇ SOL VE SAĞ B37117	Yön : İç Sol Ve Sağ Ağırlık : 0,121 kg / 0.267 lb	1K0199231J, 1K0199231J-P 1K0407183E
	VW11051 SALINCAK VE DENGE KOLU BURCU SOL VE SAĞ	Yön : Sol Ve Sağ Ağırlık : 0.121 kg / 0.267 lb	6Q0407183, 6Q0407183A
	VW11055 SALINCAK VE DENGE KOLU BURCU İÇ SOL VE SAĞ	Yön : İç Sol Ve Sağ Ağırlık : 0.121 kg / 0.267 lb	1K0407183E, 8J0407183

* Bu sayfada ve katalogdaki tüm araçların adları, markaları, modelleri, sembolleri, logoları, orjinal numaraları (oe) ve diğer üçüncü parti numaraları sadece referans amaçlı kullanılmaktadır.

GOLF
V MK5, A5
2003 - 2009

Resim	Ürün Kodu ve Açıklaması	Detay	OEM
	VW11056 SALINCAK VE DENGE KOLU BURCU ARKA SOL VE SAĐ	Şasi (Ön / Arka) : ARKA Yön : Sol Ve SaĐ Ağırlık : 0.13 kg / 0.287 lb	1K0505203A, 1K0505323D 1K0505323G, 1K0505323H 1K0505323N, 5Q0505323C
	VW11180 Z-ROT BURCU ARKA	Şasi (Ön / Arka) : ARKA Ağırlık : 0.069 kg / 0.152 lb Uzunluk : VW4015 mm / 0.00 inch Aşık Diş Çapı : VW4015K	1K0505465C*, 1K0505465D* 1K0505465H*, 1K0505465J* 1K0505465K*
	VW12131 Z-ROT BURCU ARKA	Şasi (Ön / Arka) : ARKA Ağırlık : 0.084 kg / 0.185 lb	2K0505465B*, 2K0505465C* 2K0505465E*, 2K5505465A*
	VW12131K Z-ROT BURCU ARKA	Şasi (Ön / Arka) : ARKA Ağırlık : 0.168 kg / 0.370 lb	2K0505465B*, 2K0505465C* 2K0505465E*, 2K5505465A*
	VW12159 TAŞIYICI DESTEK BURÇLARI ARKA SOL VE SAĐ	Şasi (Ön / Arka) : ARKA Yön : Sol Ve SaĐ Ağırlık : 0,130 kg / 0.287 lb	1K0505553, 1K0505553A
	AU12024 TORSİYON BURCU ARKA SOL VE SAĐ	Şasi (Ön / Arka) : ARKA Yön : Sol Ve SaĐ Ağırlık : 0.557 kg / 1.228 lb	1K0505145F, 1K0505145H 1K0505145K
	SK12003 VİRAJ DEMİR LASTİĐİ SOL VE SAĐ RUBBER	Şasi (Ön / Arka) : ÖN Yön : Sol Ve SaĐ Ağırlık : 0,075 kg / 0.165 lb Malzeme Türü : Rubber	1K0411303, 1K0411303AL* 1K0411303BK, 1K0411314 3C0411303AA*, 3C0411303T*
	SK12003K VİRAJ DEMİR LASTİĐİ SOL VE SAĐ RUBBER	Şasi (Ön / Arka) : ÖN Yön : Sol Ve SaĐ Ağırlık : 0,150 kg / 0.331 lb Malzeme Türü : Rubber	1K0411303, 1K0411303AL* 1K0411303BK, 1K0411314 3C0411303AA*, 3C0411303T*
	VW12020 VİRAJ DEMİR LASTİĐİ SOL VE SAĐ RUBBER	Şasi (Ön / Arka) : ÖN Yön : Sol Ve SaĐ Ağırlık : 0.07 kg / 0.154 lb Malzeme Türü : Rubber Not : VİRAJ ORTA LASTİĐİ	8D0511327C
	VW12020K VİRAJ DEMİR LASTİĐİ SOL VE SAĐ RUBBER	Şasi (Ön / Arka) : ÖN Yön : Sol Ve SaĐ Ağırlık : 0.14 kg / 0.309 lb Malzeme Türü : Rubber	8D0511327C*
	VW12017 AMORTİSÖR TAKOZU SOL VE SAĐ AMORTİSÖR TAKOZU	Yön : Sol Ve SaĐ Ağırlık : 0.847 kg / 1.867 lb Not : AMORTİSÖR TAKOZU	1K0412331B, 1K0412331C

* Bu sayfada ve katalogdaki tüm araçların adları, markaları, modelleri, sembolleri, logoları, orjinal numaraları (oe) ve diĐer üçüncü parti numaraları sadece referans amaçlı kullanılmaktadır.

GOLF
V MK5, A5
2003 - 2009

Resim	Ürün Kodu ve Açıklaması	Detay	OEM
	VW12109 AMORTİSÖR TAKOZU SOL VE SAĞ AMORTİSÖR RULMANI	Yön : Sol Ve Sağ Ağırlık : 0.26 kg / 0.573 lb Not : AMORTİSÖR RULMANI	6N0412249C, 6N0412249E
	VW12109K AMORTİSÖR TAKOZU SOL VE SAĞ 2 PCS	Yön : Sol Ve Sağ Ağırlık : 0.52 kg / 1.146 lb Not : 2 PCS	6N0412249C, 6N0412249E
	VW12025 MOTOR TAKOZU ALT SOL VE SAĞ MOTOR TAKOZU ALT	Yön : Alt Sol Ve Sağ Ağırlık : 0.25 kg / 0.551 lb Not : MOTOR TAKOZU ALT	1K0199867A, 1K0199867B 1K0199867Q
	VW12027 MOTOR TAKOZU SOL VE SAĞ MOTOR KULAĞI	Yön : Sol Ve Sağ Ağırlık : 2.02 kg / 4.453 lb Not : MOTOR KULAĞI	1K0199262, 1K0199262CN
	VW12029 MOTOR TAKOZU SOL VE SAĞ MOTOR TAKOZU	Yön : Sol Ve Sağ Ağırlık : 0.585 kg / 1.290 lb Not : Motor takozu	1K0199855AD, 1K0199855BA 1K0199855K
	VW12032 MOTOR TAKOZU SOL VE SAĞ MOTOR TAKOZU	Yön : Sol Ve Sağ Ağırlık : 0.64 kg / 1.411 lb Not : Motor takozu	1K0199855BB, 1K0199855L
	VW12033 MOTOR TAKOZU SOL VE SAĞ MOTOR TAKOZU	Yön : Sol Ve Sağ Ağırlık : 1.84 kg / 4.057 lb Not : Motor takozu	1K0199555AQ, 1K0199555AR 1K0199555Q, 1K0199555R 3C0199555AA, 3C0199555R
	VW12034 MOTOR TAKOZU SOL VE SAĞ MOTOR TAKOZU	Yön : Sol Ve Sağ Ağırlık : 1.9 kg / 4.189 lb Not : Motor takozu	1K0199555BA, 1K0199555BB 1K0199555L, 1K0199555M 1L0199555L
	VW12073 MOTOR TAKOZU SOL VE SAĞ MOTOR TAKOZU	Yön : Sol Ve Sağ Ağırlık : 1.643 kg / 3.622 lb Not : MOTOR TAKOZU	1K0199262AC, 1K0199262AL 1K0199262L
	VW12076 MOTOR TAKOZU SOL VE SAĞ MOTOR TAKOZU	Yön : Sol Ve Sağ Ağırlık : 1.97 kg / 4.343 lb Not : MOTOR TAKOZU	1K0199262AF, 1K0199262AT 1K0199262BB
	VW12077 MOTOR TAKOZU SOL VE SAĞ MOTOR TAKOZU	Yön : Sol Ve Sağ Ağırlık : 1.95 kg / 4.299 lb Not : MOTOR TAKOZU	1K0199262CG, 1K0199262CP





* Bu sayfada ve katalogdaki tüm araçların adları, markaları, modelleri, sembolleri, logoları, orjinal numaraları (oe) ve diğer üçüncü parti numaraları sadece referans amaçlı kullanılmaktadır.

GOLF
V MK5, A5
2003 - 2009

Resim	Ürün Kodu ve Açıklaması	Detay	OEM
	VW12082 MOTOR TAKOZU SOL VE SAĞ MOTOR TAKOZU	Yön : Sol Ve Sağ Ağırlık : 2.05 kg / 4.519 lb Not : MOTOR TAKOZU	1K0199262AK, 1K0199262K
	VW12094 MOTOR TAKOZU SOL VE SAĞ MOTOR TAKOZU	Yön : Sol Ve Sağ Ağırlık : 1.872 kg / 4.127 lb Not : MOTOR TAKOZU	1K0199555N
	VW12097 MOTOR TAKOZU SOL VE SAĞ MOTOR TAKOZU	Yön : Sol Ve Sağ Ağırlık : 0.251 kg / 0.553 lb Not : MOTOR TAKOZU	1K0199868, 1K0199868A 1K0199868C, 1K0199868P 1K0199868Q
	VW12110 MOTOR TAKOZU SOL VE SAĞ MOTOR TAKOZU	Yön : Sol Ve Sağ Ağırlık : 1.918 kg / 4.228 lb Not : MOTOR TAKOZU	1K0199262AB, 1K0199262AM 1K0199262M
	VW12124 MOTOR TAKOZU SOL VE SAĞ	Yön : Sol Ve Sağ Ağırlık : 1.927 kg / 4.248 lb	1K0199262A, 1K0199262AA 1K0199262AS
	VW12106 ŞANZIMAN TAKOZU SOL ŞANZUMAN TAKOZU SOL	Yön : Sol Ağırlık : 1.95 kg / 4.299 lb Not : ŞANZUMAN TAKOZU SOL	1K0199555AT, 1K0199555T
	VW12038 SÜSPANSİYON TAKOZU SOL VE SAĞ SUS. ARA YATAK TAKOZ ARKA	Yön : Sol Ve Sağ Ağırlık : 0.12 kg / 0.265 lb Not : SUS. ARA YATAK TAKOZ ARKA	3C0 511 359, 3C0511359
	VW12051 SÜSPANSİYON TAKOZU SOL VE SAĞ LASTİK DAYANAK SÜSPANSİYON	Yön : Sol Ve Sağ Ağırlık : 0.045 kg / 0.099 lb Not : LASTİK DAYANAK SÜSPANSİYON	1K0412303B
	VW12086 RADYATÖR TAKOZU SOL VE SAĞ RADYATÖR ÜST LASTİĞİ	Yön : Sol Ve Sağ Ağırlık : 0.024 kg / 0.053 lb Not : RADYATÖR ÜST LASTİĞİ	1K0121367F
	VW13006 DİREKSİYON KÖRÜĞÜ	Ağırlık : 0.145 kg / 0.320 lb	1K0423831A, 5C0423831
	VW13006K DİREKSİYON KÖRÜĞÜ SOL VE SAĞ 2 PİECES	Ağırlık : 0.29 kg / 0.639 lb	1K0423831A, 5C0423831

* Bu sayfada ve katalogdaki tüm araçların adları, markaları, modelleri, sembolleri, logoları, orijinal numaraları (oe) ve diğer üçüncü parti numaraları sadece referans amaçlı kullanılmaktadır.

GOLF
V MK5, A5
2003 - 2009







Resim	Ürün Kodu ve Açıklaması	Detay	OEM
	VW14003 AKS KÖRÜĞÜ +KELEPÇE+YAĞ. DIŞ	Ağırlık : 0.25 kg / 0.551 lb	1K0 498 203, 1K0498203
	VW14011 AKS KÖRÜĞÜ +KELEPÇE+YAĞ. İÇ	Ağırlık : 0.236 kg / 0.520 lb	1K0498201D
	AU15001 AMORTİSÖR KÖRÜĞÜ ÖN	Şasi (Ön / Arka) : ÖN Ağırlık : 0,110 kg / 0.243 lb	6N0413175A
	VW15002 AMORTİSÖR KÖRÜĞÜ ARKA	Şasi (Ön / Arka) : ARKA	900064

GOLF
VI MK6, A6
2009 - 2012

Resim	Ürün Kodu ve Açıklaması	Detay	OEM
	VW1014 ROTİL ÖN ALT SAĞ Ø15,6 RB2536	Ağırlık : 0,565 kg / 1.246 lb Konik Ölçüsü : Ø15,6 Bağlantı Delik Çapı : Ø10,5 Aşık Diş Çapı : M12X1,5	1K0407366B, 1K0407366C 1K0407366E, 5Q0407366A
	VW1015 ROTİL ÖN ALT SOL Ø15,6 RB2537	Ağırlık : 0,565 kg / 1.246 lb Konik Ölçüsü : Ø15,6 Bağlantı Delik Çapı : Ø10,5 Aşık Diş Çapı : M12X1,5	1K0407365B, 1K0407365C 1K0407365E, 5Q0407365A
	VW2008 ROTBAŞI ÖN SAĞ RD0342	Ağırlık : 0,412 kg / 0.908 lb Uzunluk : 95 mm / 3.74 inch Gövde Diş Çapı : M16X1,5 Aşık Diş Çapı : M12X1,5 Aşık Konik Çapı : Ø12,7	1K0423812A, 1K0423812C 1K0423812E, 1K0423812G 1K0423812J, 1K0423812K 1KD423812A
	VW2009 ROTBAŞI ÖN SOL RD0343	Ağırlık : 0,412 kg / 0.908 lb Uzunluk : 95 mm / 3.74 inch Gövde Diş Çapı : M16X1,5 Aşık Diş Çapı : M12X1,5 Aşık Konik Çapı : Ø13,5	1K0423811A, 1K0423811C 1K0423811E, 1K0423811G 1K0423811J, 1K0423811K 1KD423811A
	VW3009 ROTMİLİ SAĞ-SOL 310 RB2838	Ağırlık : 0,665 kg / 1.466 lb Uzunluk : 311 mm / 12.24 inch Gövde Diş Çapı : M16X1,5 Aşık Diş Çapı : M16X1,5	1K0423810A
	VW20083009 ROT TAKIMI ÖN AKS SAĞ RB288137	Ağırlık : 1,078 kg / 2.377 lb Rotbaşı : VW2008 Rotmili : VW3009	











* Bu sayfada ve katalogdaki tüm araçların adları, markaları, modelleri, sembolleri, logoları, orjinal numaraları (oe) ve diğer üçüncü parti numaraları sadece referans amaçlı kullanılmaktadır.

GOLF
VI MK6, A6
2009 - 2012

Resim	Ürün Kodu ve Açıklaması	Detay	OEM
	VW20093009 ROT TAKIMI ÖN SOL RB288138	Ağırlık : 1,077 kg / 2.374 lb Rotbaşı : VW2009 Rotmili : VW3009	
	SK4005 Z ROT ÖM SAĞ-SOL L=335MM	Ağırlık : 0,322 kg / 0.710 lb Malzeme Türü : Metal Uzunluk : 335 mm / 13.19 inch Aşık Diş Çapı : M12X1,5	5Q0411315B
	VW4014 Z ROT ÖN SAĞ-SOL METAL 335 RB2935	Ağırlık : 0,46 kg / 1.014 lb Malzeme Türü : Metal Uzunluk : 335 mm / 13.19 inch Aşık Diş Çapı : M12X1,5	1K0411315B, 1K0411315D 1K0411315J, 1K0411315K 1K0411315R, 5Q0411315A 5Q0411315B
	VW4015 Z ROT SOL VE SAĞ METAL RB2937	Ağırlık : 0,373 kg / 0.822 lb Malzeme Türü : Metal Uzunluk : 95,5 mm / 3.76 inch Aşık Diş Çapı : M10X1,5	1K0505465C, 1K0505465D 1K0505465H, 1K0505465J 1K0505465K
	VW4015K Z ROT SOL VE SAĞ METAL	Ağırlık : 0,373 kg / 0.822 lb Malzeme Türü : Metal Uzunluk : 95,5 mm / 3.76 inch Aşık Diş Çapı : M10X1,5	1K0505465C, 1K0505465D 1K0505465H, 1K0505465J 1K0505465K
	SK6011 SALINCAK ÖN ALT SAĞ RD10230	Ağırlık : 4,264 kg / 9.401 lb Malzeme Türü : Sac Metal	1K0407152B**, 1K0407152BC**
	SK6011J SALINCAK ÖN ALT SAĞ RD10232	Ağırlık : 3,691 kg / 8.137 lb Malzeme Türü : Sac Metal	1K0407152B, 1K0407152BC
	SK6012 SALINCAK ÖN ALT SOL RD10231	Ağırlık : 4,264 kg / 9.401 lb Malzeme Türü : Sac Metal	1K0407151BC**, 1K0407151H**
	SK6012J SALINCAK ÖN ALT SOL RD10233	Ağırlık : 3,691 kg / 8.137 lb Malzeme Türü : Sac Metal	1K0407151BC, 1K0407151H
	SK9001 SALINCAK ARKA ALT	Ağırlık : 0,701 kg / 1.545 lb Malzeme Türü : Sac Metal	1K0501529J
	VW9001 SALINCAK ARKA	Ağırlık : 2,55 kg / 5.622 lb Malzeme Türü : Sac Metal	1K0505311AA, 1K0505311AB 1K0505311H, 1K0505311S 1K0505311T

* Bu sayfada ve katalogdaki tüm araçların adları, markaları, modelleri, sembolleri, logoları, orjinal numaraları (oe) ve diğer üçüncü parti numaraları sadece referans amaçlı kullanılmaktadır.

GOLF
VI MK6, A6
2009 - 2012

Resim	Ürün Kodu ve Açıklaması	Detay	OEM
	AU11014 SALINCAK VE DENGELER KOLU BURCU ARKA SOL VE SAĞ	Şasi (Ön / Arka) : ARKA Yön : Sol Ve Sağ Ağırlık : 0,192 kg / 0,423 lb	1K0505543A
	AU11035 SALINCAK VE DENGELER KOLU BURCU ARKA SOL VE SAĞ	Şasi (Ön / Arka) : ARKA Yön : Sol Ve Sağ Ağırlık : 0,25 kg / 0,551 lb	1K0505171C
	SK11009 SALINCAK VE DENGELER KOLU BURCU ARKA SOL VE SAĞ	Şasi (Ön / Arka) : ARKA Yön : Sol Ve Sağ Ağırlık : 0,176 kg / 0,388 lb	1K0501529J*
	SK11010 SALINCAK VE DENGELER KOLU BURCU ARKA SOL VE SAĞ	Şasi (Ön / Arka) : ARKA Yön : Sol Ve Sağ Ağırlık : 0,196 kg / 0,432 lb Not : BÜYÜK	1K0501529J*
	VW11037 SALINCAK VE DENGELER KOLU BURCU SOL VE SAĞ	Yön : Sol Ve Sağ Ağırlık : 0,11 kg / 0,243 lb	1K0505279A
	VW11042 SALINCAK VE DENGELER KOLU BURCU ORTA SOL VE SAĞ	Yön : Orta Sol Ve Sağ Ağırlık : 0,182 kg / 0,401 lb	1K0407182, 5Q0407182
	VW11043 SALINCAK VE DENGELER KOLU BURCU SAĞ B22141	Yön : Sağ Diğer Taraf : VW11044 Ağırlık : 0,659 kg / 1,453 lb	1K0199232G, 1K0199232H 1K0199232J
	VW11043B SALINCAK VE DENGELER KOLU BURCU SAĞ	Yön : Sağ Diğer Taraf : VW11044B Ağırlık : 0,659 kg / 1,453 lb Not : İÇ BURÇSUZ	1K0199232G, 1K0199232H 1K0199232J
	VW11044 SALINCAK VE DENGELER KOLU BURCU SOL B22142	Yön : Sol Diğer Taraf : VW11043 Ağırlık : 0,678 kg / 1,495 lb	1K0199231G, 1K0199231H 1K0199231J
	VW11044B SALINCAK VE DENGELER KOLU BURCU SOL	Yön : Sol Diğer Taraf : VW11043B Ağırlık : 0,678 kg / 1,495 lb Not : İÇ BURÇSUZ	1K0199231G, 1K0199231H 1K0199231J
	VW11047 SALINCAK VE DENGELER KOLU BURCU İÇ SOL VE SAĞ B37117	Yön : İç Sol Ve Sağ Ağırlık : 0,121 kg / 0,267 lb	1K0199231J, 1K0199231J-P 1K0407183E

* Bu sayfada ve katalogdaki tüm araçların adları, markaları, modelleri, sembolleri, logoları, orijinal numaraları (oe) ve diğer üçüncü parti numaraları sadece referans amaçlı kullanılmaktadır.

GOLF
VI MK6, A6
2009 - 2012

Resim	Ürün Kodu ve Açıklaması	Detay	OEM
	VW11051 SALINCAK VE DENGİ KOLU BURCU SOL VE SAĞ	Yön : Sol Ve Sağ Ağırlık : 0.121 kg / 0.267 lb	6Q0407183, 6Q0407183A
	VW11055 SALINCAK VE DENGİ KOLU BURCU İÇ SOL VE SAĞ	Yön : İç Sol Ve Sağ Ağırlık : 0.121 kg / 0.267 lb	1K0407183E, 8J0407183
	VW11056 SALINCAK VE DENGİ KOLU BURCU ARKA SOL VE SAĞ	Şasi (Ön / Arka) : ARKA Yön : Sol Ve Sağ Ağırlık : 0.13 kg / 0.287 lb	1K0505203A, 1K0505323D 1K0505323G, 1K0505323H 1K0505323N, 5Q0505323C
	VW11180 Z-ROT BURCU ARKA	Şasi (Ön / Arka) : ARKA Ağırlık : 0.069 kg / 0.152 lb Uzunluk : VW4015 mm / 0.00 inch Aşık Dış Çapı : VW4015K	1K0505465C*, 1K0505465D* 1K0505465H*, 1K0505465J* 1K0505465K*
	VW12159 TAŞIYICI DESTEK BURÇLARI ARKA SOL VE SAĞ	Şasi (Ön / Arka) : ARKA Yön : Sol Ve Sağ Ağırlık : 0,130 kg / 0.287 lb	1K0505553, 1K0505553A
	AU12024 TORSİYON BURCU ARKA SOL VE SAĞ	Şasi (Ön / Arka) : ARKA Yön : Sol Ve Sağ Ağırlık : 0.557 kg / 1.228 lb	1K0505145F, 1K0505145H 1K0505145K
	SK12003 VİRAJ DEMİR LASTİĞİ SOL VE SAĞ RUBBER	Şasi (Ön / Arka) : ÖN Yön : Sol Ve Sağ Ağırlık : 0,075 kg / 0.165 lb Malzeme Türü : Rubber	1K0411303, 1K0411303AL* 1K0411303BK, 1K0411314 3C0411303AA*, 3C0411303T*
	SK12003K VİRAJ DEMİR LASTİĞİ SOL VE SAĞ RUBBER	Şasi (Ön / Arka) : ÖN Yön : Sol Ve Sağ Ağırlık : 0,150 kg / 0.331 lb Malzeme Türü : Rubber	1K0411303, 1K0411303AL* 1K0411303BK, 1K0411314 3C0411303AA*, 3C0411303T*
	VW12137 VİRAJ DEMİR LASTİĞİ	Şasi (Ön / Arka) : ARKA Ağırlık : 0,070 kg / 0.154 lb Not : Ø17mm	1K0511327AQ
	VW12137K VİRAJ DEMİR LASTİĞİ	Şasi (Ön / Arka) : ARKA Ağırlık : 0,140 kg / 0.309 lb Not : KIT	1K0511327AQ
	VW12109 AMORTİSÖR TAKOZU SOL VE SAĞ AMORTİSÖR RULMANI	Yön : Sol Ve Sağ Ağırlık : 0.26 kg / 0.573 lb Not : AMORTİSÖR RULMANI	6N0412249C, 6N0412249E





* Bu sayfada ve katalogdaki tüm araçların adları, markaları, modelleri, sembolleri, logoları, orijinal numaraları (oe) ve diğer üçüncü parti numaraları sadece referans amaçlı kullanılmaktadır.

GOLF
VI MK6, A6
2009 - 2012





Resim	Ürün Kodu ve Açıklaması	Detay	OEM
	VW12109K AMORTİSÖR TAKOZU SOL VE SAĞ 2 PCS	Yön : Sol Ve Sağ Ağırlık : 0.52 kg / 1.146 lb Not : 2 PCS	6N0412249C, 6N0412249E
	VW12025 MOTOR TAKOZU ALT SOL VE SAĞ MOTOR TAKOZU ALT	Yön : Alt Sol Ve Sağ Ağırlık : 0.25 kg / 0.551 lb Not : MOTOR TAKOZU ALT	1K0199867A, 1K0199867B 1K0199867Q
	VW12027 MOTOR TAKOZU SOL VE SAĞ MOTOR KULAĞI	Yön : Sol Ve Sağ Ağırlık : 2.02 kg / 4.453 lb Not : MOTOR KULAĞI	1K0199262, 1K0199262CN
	VW12029 MOTOR TAKOZU SOL VE SAĞ MOTOR TAKOZU	Yön : Sol Ve Sağ Ağırlık : 0.585 kg / 1.290 lb Not : Motor takozu	1K0199855AD, 1K0199855BA 1K0199855K
	VW12073 MOTOR TAKOZU SOL VE SAĞ MOTOR TAKOZU	Yön : Sol Ve Sağ Ağırlık : 1.643 kg / 3.622 lb Not : MOTOR TAKOZU	1K0199262AC, 1K0199262AL 1K0199262L
	VW12078 MOTOR TAKOZU SOL VE SAĞ ŞANZUMAN TAKOZU	Yön : Sol Ve Sağ Ağırlık : 1.78 kg / 3.924 lb Not : ŞANZUMAN TAKOZU	1K0199555AC
	VW12082 MOTOR TAKOZU SOL VE SAĞ MOTOR TAKOZU	Yön : Sol Ve Sağ Ağırlık : 2.05 kg / 4.519 lb Not : MOTOR TAKOZU	1K0199262AK, 1K0199262K
	VW12097 MOTOR TAKOZU SOL VE SAĞ MOTOR TAKOZU	Yön : Sol Ve Sağ Ağırlık : 0.251 kg / 0.553 lb Not : MOTOR TAKOZU	1K0199868, 1K0199868A 1K0199868C, 1K0199868P 1K0199868Q
	VW12038 SÜSPANSİYON TAKOZU SOL VE SAĞ SUS. ARA YATAK TAKOZ ARKA	Yön : Sol Ve Sağ Ağırlık : 0.12 kg / 0.265 lb Not : SUS. ARA YATAK TAKOZ ARKA	3C0 511 359, 3C0511359
	VW12051 SÜSPANSİYON TAKOZU SOL VE SAĞ LASTİK DAYANAK SÜSPANSİYON	Yön : Sol Ve Sağ Ağırlık : 0.045 kg / 0.099 lb Not : LASTİK DAYANAK SÜSPANSİYON	1K0412303B
	VW12086 RADYATÖR TAKOZU SOL VE SAĞ RADYATÖR ÜST LASTİĞİ	Yön : Sol Ve Sağ Ağırlık : 0.024 kg / 0.053 lb Not : RADYATÖR ÜST LASTİĞİ	1K0121367F

* Bu sayfada ve katalogdaki tüm araçların adları, markaları, modelleri, sembolleri, logoları, orijinal numaraları (oe) ve diğer üçüncü parti numaraları sadece referans amaçlı kullanılmaktadır.

GOLF VI MK6, A6 2009 - 2012











Resim	Ürün Kodu ve Açıklaması	Detay	OEM
	VW13006 DİREKSİYON KÖRÜĞÜ	Ağırlık : 0.145 kg / 0.320 lb	1K0423831A, 5C0423831
	VW13006K DİREKSİYON KÖRÜĞÜ SOL VE SAĞ 2 PİECES	Ağırlık : 0.29 kg / 0.639 lb	1K0423831A, 5C0423831
	VW14003 AKS KÖRÜĞÜ +KELEPÇE+YAĞ. DIŞ	Ağırlık : 0.25 kg / 0.551 lb	1K0 498 203, 1K0498203
	AU15001 AMORTİSÖR KÖRÜĞÜ ÖN	Şasi (Ön / Arka) : ÖN Ağırlık : 0,110 kg / 0.243 lb	6N0413175A
	VW15002 AMORTİSÖR KÖRÜĞÜ ARKA	Şasi (Ön / Arka) : ARKA	900064

GOLF VII MK7, MQB 2012 - 2020

Resim	Ürün Kodu ve Açıklaması	Detay	OEM
	VW1031 ROTİL ÖN ALT SAĞ Ø15,2	Ağırlık : 0,59 kg / 1.301 lb Konik Ölçüsü : Ø15,2 Aşık Diş Çapı : M12X1,5	3C0407366B
	VW1032 ROTİL ÖN ALT SOL Ø15,2	Ağırlık : 0,59 kg / 1.301 lb Konik Ölçüsü : Ø15,2 Aşık Diş Çapı : M12X1,5	3C0407365B
	VW2008 ROTBAŞI ÖN SAĞ RD0342	Ağırlık : 0,412 kg / 0.908 lb Uzunluk : 95 mm / 3.74 inch Gövde Diş Çapı : M16X1,5 Aşık Diş Çapı : M12X1,5 Aşık Konik Çapı : Ø12,7	1K0423812A, 1K0423812C 1K0423812E, 1K0423812G 1K0423812J, 1K0423812K 1KD423812A
	VW2009 ROTBAŞI ÖN SOL RD0343	Ağırlık : 0,412 kg / 0.908 lb Uzunluk : 95 mm / 3.74 inch Gövde Diş Çapı : M16X1,5 Aşık Diş Çapı : M12X1,5 Aşık Konik Çapı : Ø13,5	1K0423811A, 1K0423811C 1K0423811E, 1K0423811G 1K0423811J, 1K0423811K 1KD423811A
	VW3009 ROTMİLİ SAĞ-SOL 310 RB2838	Ağırlık : 0,665 kg / 1.466 lb Uzunluk : 311 mm / 12.24 inch Gövde Diş Çapı : M16X1,5 Aşık Diş Çapı : M16X1,5	1K0423810A











* Bu sayfada ve katalogdaki tüm araçların adları, markaları, modelleri, sembolleri, logoları, orjinal numaraları (oe) ve diğer üçüncü parti numaraları sadece referans amaçlı kullanılmaktadır.

GOLF
VII MK7, MQB
2012 - 2020

Resim	Ürün Kodu ve Açıklaması	Detay	OEM
	VW20083009 ROT TAKIMI ÖN AKS SAĞ RB288137	Ağırlık : 1,078 kg / 2.377 lb Rotbaşı : VW2008 Rotmilii : VW3009	
	VW20093009 ROT TAKIMI ÖN SOL RB288138	Ağırlık : 1,077 kg / 2.374 lb Rotbaşı : VW2009 Rotmilii : VW3009	
	SK4005 Z ROT ÖM SAĞ-SOL L=335MM	Ağırlık : 0,322 kg / 0.710 lb Malzeme Türü : Metal Uzunluk : 335 mm / 13.19 inch Aşık Diş Çapı : M12X1,5	5Q0411315B
	VW4014 Z ROT ÖN SAĞ-SOL METAL 335 RB2935	Ağırlık : 0,46 kg / 1.014 lb Malzeme Türü : Metal Uzunluk : 335 mm / 13.19 inch Aşık Diş Çapı : M12X1,5	1K0411315B, 1K0411315D 1K0411315J, 1K0411315K 1K0411315R, 5Q0411315A 5Q0411315B
	VW4031 Z ROT ARKA PLASTİK	Ağırlık : 0,15 kg / 0.331 lb Malzeme Türü : Plastik Uzunluk : 70 mm / 2.76 inch Aşık Diş Çapı : M10X1,5	5Q0505465A, 5Q0505465C
	AU9009 SALINCAK ALT SOL VE SAĞ	Ağırlık : 2,910 kg / 6.415 lb Malzeme Türü : Sac Metal	5Q0505311C, 5Q0505311D
	AU9012 SALINCAK ARKA ALT SAĞ	Ağırlık : 1,640 kg / 3.616 lb Malzeme Türü : Sac Metal	5Q0505224D
	AU9013 SALINCAK ARKA ALT SOL	Ağırlık : 1,640 kg / 3.616 lb Malzeme Türü : Sac Metal	5Q0505223D
	VW6079 SALINCAK VE DENGE KOLU ÖN ALT SAĞ SAC LEVHA	Ağırlık : 3,624 kg / 7.990 lb Malzeme Türü : Sac Metal	5Q0407152T, 81A407152C 81A407152E, 81A407152F
	VW6079J SALINCAK VE DENGE KOLU ÖN ALT SAĞ SAC LEVHA	Ağırlık : 3,202 kg / 7.059 lb Malzeme Türü : Sac Metal	5Q0407154E, 5WA407151A 5WA407152A
	VW6080 SALINCAK VE DENGE KOLU ÖN ALT SOL SAC LEVHA	Ağırlık : 3,624 kg / 7.990 lb Malzeme Türü : Sac Metal	5Q0407151T, 81A407151C 81A407151E, 81A407151F

* Bu sayfada ve katalogdaki tüm araçların adları, markaları, modelleri, sembolleri, logoları, orjinal numaraları (oe) ve diğer üçüncü parti numaraları sadece referans amaçlı kullanılmaktadır.

GOLF
VII MK7, MQB
2012 - 2020

Resim	Ürün Kodu ve Açıklaması	Detay	OEM
	VW6080J SALINCAK VE DENGE KOLU ÖN ALT SOL SAC LEVHA	Ağırlık : 3,202 kg / 7.059 lb Malzeme Türü : Sac Metal	5Q0407153E, 5WA407151A 5WA407152A
	VW9001 SALINCAK ARKA	Ağırlık : 2,55 kg / 5.622 lb Malzeme Türü : Sac Metal	1K0505311AA, 1K0505311ABÂ 1K0505311H, 1K0505311S 1K0505311T
	VW9002 SALINCAK ÖN TARAF SAĞ	Ağırlık : 1,79 kg / 3.946 lb Malzeme Türü : Sac Metal	1K0505224E, 1K0505224H 1K0505224K
	VW9003 SALINCAK ÖN TARAF SOL	Ağırlık : 1,79 kg / 3.946 lb Malzeme Türü : Sac Metal	1K0505223E, 1K0505223H 1K0505223K
	VW9004 SALINCAK ARKA	Ağırlık : 1,3 kg / 2.866 lb Malzeme Türü : Sac Metal	5Q0505323C, 5Q0505323D
	VW9005 SALINCAK ARKA ALT ÖNDEN	Ağırlık : 0,566 kg / 1.248 lb Malzeme Türü : Sac Metal	5Q0501529C, 5Q0501529D 5Q0501529E, 5Q0501529F
	AU11035 SALINCAK VE DENGE KOLU BURCU ARKA SOL VE SAĞ	Şasi (Ön / Arka) : ARKA Yön : Sol Ve Sağ Ağırlık : 0,25 kg / 0.551 lb	1K0505171C
	AU11068 SALINCAK VE DENGE KOLU BURCU ARKA ALT SOL VE SAĞ METAL	Şasi (Ön / Arka) : ARKA Yön : Alt Sol Ve Sağ Ağırlık : 0,201 kg / 0.443 lb Malzeme Türü : Metal	PART OF 5Q0505223D, PART OF 5Q0505224D
	AU11070 SALINCAK VE DENGE KOLU BURCU ARKA ALT	Şasi (Ön / Arka) : ARKA Yön : Alt Ağırlık : 0,100 kg / 0.220 lb	5Q0505171, 5Q0505311C 5Q0505311CSK, 5Q0505311D 5Q0505311DSK
	AU11088 SALINCAK VE DENGE KOLU BURCU ARKA	Şasi (Ön / Arka) : ARKA Ağırlık : 0,165 kg / 0.364 lb	1K0505541C, 1K0505541D 3C0505541
	VW11037 SALINCAK VE DENGE KOLU BURCU SOL VE SAĞ	Yön : Sol Ve Sağ Ağırlık : 0.11 kg / 0.243 lb	1K0505279A











* Bu sayfada ve katalogdaki tüm araçların adları, markaları, modelleri, sembolleri, logoları, orjinal numaraları (oe) ve diğer üçüncü parti numaraları sadece referans amaçlı kullanılmaktadır.

GOLF
VII MK7, MQB
2012 - 2020

Resim	Ürün Kodu ve Açıklaması	Detay	OEM
	VW11042 SALINCAK VE DENGE KOLU BURCU ORTA SOL VE SAĞ	Yön : Orta Sol Ve Sağ Ağırlık : 0,182 kg / 0.401 lb	1K0407182, 5Q0407182
	VW11063 SALINCAK VE DENGE KOLU BURCU SOL VE SAĞ	Yön : Sol Ve Sağ Ağırlık : 0.34 kg / 0.750 lb	5Q0407183D, 5Q0407183E
	VW11075 SALINCAK VE DENGE KOLU BURCU ARKA SOL VE SAĞ	Şasi (Ön / Arka) : ARKA Yön : Sol Ve Sağ Ağırlık : 0,870 kg / 1.918 lb Not : FORWARD and INNER	Part of 5Q0501529C, Part of 5Q0501529D Part of 5Q0501529E, Part of 5Q0501529F
	VW11076 SALINCAK VE DENGE KOLU BURCU ARKA SOL VE SAĞ	Şasi (Ön / Arka) : ARKA Yön : Sol Ve Sağ Ağırlık : 0,870 kg / 1.918 lb Not : FORWARD and OUTER	Part of 5Q0501529C, Part of 5Q0501529D Part of 5Q0501529E, Part of 5Q0501529F
	VW11183 SALINCAK VE DENGE KOLU BURCU ÖN ALT	Şasi (Ön / Arka) : ÖN Yön : Alt Ağırlık : 0,322 kg / 0.710 lb	5Q0407182F, 5Q0407183D 5Q0407183E, 5Q0407183J 5Q0407183L
	VW12159 TAŞIYICI DESTEK BURÇLARI ARKA SOL VE SAĞ	Şasi (Ön / Arka) : ARKA Yön : Sol Ve Sağ Ağırlık : 0,130 kg / 0.287 lb	1K0505553, 1K0505553A
	AU12027 AMORTİSÖR TAKOZU ARKA ÜST SAĞ	Şasi (Ön / Arka) : ARKA Yön : Üst Sağ Ağırlık : 0,415 kg / 0.915 lb	5Q0513353H
	VW12109 AMORTİSÖR TAKOZU SOL VE SAĞ AMORTİSÖR RULMANI	Yön : Sol Ve Sağ Ağırlık : 0.26 kg / 0.573 lb Not : AMORTİSÖR RULMANI	6N0412249C, 6N0412249E
	VW12109K AMORTİSÖR TAKOZU SOL VE SAĞ 2 PCS	Yön : Sol Ve Sağ Ağırlık : 0.52 kg / 1.146 lb Not : 2 PCS	6N0412249C, 6N0412249E
	AU12019 MOTOR TAKOZU SOL VE SAĞ MOTOR TAKOZU	Yön : Sol Ve Sağ Ağırlık : 0.204 kg / 0.450 lb Malzeme Türü : Motor Takoğu	5Q0198037, 5QD199867
	AU12019K MOTOR TAKOZU SOL VE SAĞ MOTOR TAKOZU TAKIM	Yön : Sol Ve Sağ Ağırlık : 0.408 kg / 0.899 lb Malzeme Türü : Motor Takoğu Takım	5Q0198037

* Bu sayfada ve katalogdaki tüm araçların adları, markaları, modelleri, sembolleri, logoları, orjinal numaraları (oe) ve diğer üçüncü parti numaraları sadece referans amaçlı kullanılmaktadır.

GOLF
VII MK7, MQB
2012 - 2020

Resim	Ürün Kodu ve Açıklaması	Detay	OEM
	AU12020 MOTOR TAKOZU SOL VE SAĞ MOTOR TAKOZU	Yön : Sol Ve Sağ Ağırlık : 0.21 kg / 0.463 lb Malzeme Türü : Motor Takozu	5Q0198037, 5Q0199868 5QD199868
	AU12022 MOTOR TAKOZU SOL VE SAĞ MOTOR TAKOZU	Yön : Sol Ve Sağ Ağırlık : 1.58 kg / 3.483 lb Malzeme Türü : Motor Takozu	5Q0199262, 5Q0199262BH 5Q0199262DE
	AU12023 MOTOR TAKOZU SOL VE SAĞ MOTOR TAKOZU 7 İLERİ	Yön : Sol Ve Sağ Ağırlık : 1.58 kg / 3.483 lb Malzeme Türü : Motor Takozu Not : 7 İLERİ	5Q0199262BE, 5Q0199262BF
	AU12026 MOTOR TAKOZU ÖN SOL VE SAĞ	Şasi (Ön / Arka) : ÖN Yön : Sol Ve Sağ Ağırlık : 0,850 kg / 1.874 lb	5Q0199855AD, 5Q0199855J 5Q0199855P, 5Q0199855Q
	SK12005 MOTOR TAKOZU ÖN SAĞ	Şasi (Ön / Arka) : ÖN Yön : Sağ Ağırlık : 1,575 kg / 3.472 lb	5Q0199262CK
	VW12157 MOTOR TAKOZU ÖN SOL VE SAĞ	Şasi (Ön / Arka) : ÖN Yön : Sol Ve Sağ Ağırlık : 2.2 kg / 4.850 lb	5Q0199555AF, 5Q0199555T 5Q01999555AP
	AU12042 SÜSPANSİYON TAKOZU ARKA	Şasi (Ön / Arka) : ARKA Ağırlık : 0,095 kg / 0.209 lb	5N0412303C
	VW12051 SÜSPANSİYON TAKOZU SOL VE SAĞ LASTİK DAYANAK SÜSPANSİYON	Yön : Sol Ve Sağ Ağırlık : 0.045 kg / 0.099 lb Not : LASTİK DAYANAK SÜSPANSİYON	1K0412303B
	VW12086 RADYATÖR TAKOZU SOL VE SAĞ RADYATÖR ÜST LASTİĞİ	Yön : Sol Ve Sağ Ağırlık : 0.024 kg / 0.053 lb Not : RADYATÖR ÜST LASTİĞİ	1K0121367F
	VW13006 DİREKSİYON KÖRÜĞÜ	Ağırlık : 0.145 kg / 0.320 lb	1K0423831A, 5C0423831
	VW13006K DİREKSİYON KÖRÜĞÜ SOL VE SAĞ 2 PİECES	Ağırlık : 0.29 kg / 0.639 lb	1K0423831A, 5C0423831



* Bu sayfada ve katalogdaki tüm araçların adları, markaları, modelleri, sembolleri, logoları, orjinal numaraları (oe) ve diğer üçüncü parti numaraları sadece referans amaçlı kullanılmaktadır.

GOLF
VIII MK8
2020 -

Resim	Ürün Kodu ve Açıklaması	Detay	OEM
	VW1051 ROTİL ALT SAĞ	Ağırlık : 0,630 kg / 1.389 lb	5Q0407366A, 5Q0407366E
	VW1052 ROTİL ALT SOL	Ağırlık : 0,630 kg / 1.389 lb	5Q0407366E
	VW2031 ROTBAŞI SAĞ	Ağırlık : 0,515 kg / 1.135 lb	5WA423812B, 5WA423812C 5WA423812D
	VW2032 ROTBAŞI SOL	Ağırlık : 0,515 kg / 1.135 lb	5WA423811B, 5WA423811C 5WA423811D
	VW3030 ROTMİLİ ÖN	Ağırlık : 0,655 kg / 1.444 lb Uzunluk : 310 mm / 12.20 inch Gövde Diş Çapı : M16X1,5 Aşık Diş Çapı : M16X1,5	5WA423810C
	VW4014 Z ROT ÖN SAĞ-SOL METAL 335 RB2935	Ağırlık : 0,46 kg / 1.014 lb Malzeme Türü : Metal Uzunluk : 335 mm / 13.19 inch Aşık Diş Çapı : M12X1,5	1K0411315B, 1K0411315D 1K0411315J, 1K0411315K 1K0411315R, 5Q0411315A 5Q0411315B
	VW4035 Z ROT ARKA PLASTİK	Ağırlık : 0,165 kg / 0.364 lb Malzeme Türü : Plastik Uzunluk : 111 mm / 4.37 inch	5WA505465A
	VW6079J SALINCAĞ VE DENGE KOLU ÖN ALT SAĞ SAC LEVHA	Ağırlık : 3,202 kg / 7.059 lb Malzeme Türü : Sac Metal	5Q0407154E, 5WA407151A 5WA407152A
	VW6080J SALINCAĞ VE DENGE KOLU ÖN ALT SOL SAC LEVHA	Ağırlık : 3,202 kg / 7.059 lb Malzeme Türü : Sac Metal	5Q0407153E, 5WA407151A 5WA407152A
	VW6089 SALINCAĞ VE DENGE KOLU ÖN ALT SAĞ SAC LEVHA	Ağırlık : 3,624 kg / 7.990 lb Malzeme Türü : Sac Metal	5WA407152A
	VW6090 SALINCAĞ VE DENGE KOLU ÖN ALT SOL SAC LEVHA	Ağırlık : 3,624 kg / 7.990 lb Malzeme Türü : Sac Metal	5WA407151A

* Bu sayfada ve katalogdaki tüm araçların adları, markaları, modelleri, sembolleri, logoları, orjinal numaraları (oe) ve diğer üçüncü parti numaraları sadece referans amaçlı kullanılmaktadır.











GOLF VIII MK8 2020 -

Resim	Ürün Kodu ve Açıklaması	Detay	OEM
	VW9012 SALINCAK VE DENG KOLU ARKA ALT ÖNDEN SAC LEVHA	Ağırlık : 0,675 kg / 1.488 lb Malzeme Türü : Sac Metal	5Q0501529G
	VW11042 SALINCAK VE DENG KOLU BURCU ORTA SOL VE SAĞ	Yön : Orta Sol Ve Sağ Ağırlık : 0,182 kg / 0.401 lb	1K0407182, 5Q0407182
	VW11183 SALINCAK VE DENG KOLU BURCU ÖN ALT	Şasi (Ön / Arka) : ÖN Yön : Alt Ağırlık : 0,322 kg / 0.710 lb	5Q0407182F, 5Q0407183D 5Q0407183E, 5Q0407183J 5Q0407183L
	SK12005 MOTOR TAKOZU ÖN SAĞ	Şasi (Ön / Arka) : ÖN Yön : Sağ Ağırlık : 1,575 kg / 3.472 lb	5Q0199262CK

GTI MK5, A5 2006 - 2009

Resim	Ürün Kodu ve Açıklaması	Detay	OEM
	VW1014 ROTİL ÖN ALT SAĞ Ø15,6 RB2536	Ağırlık : 0,565 kg / 1.246 lb Konik Ölçüsü : Ø15,6 Bağlantı Delik Çapı : Ø10,5 Aşık Dış Çapı : M12X1,5	1K0407366B, 1K0407366C 1K0407366E, 5Q0407366A
	VW1015 ROTİL ÖN ALT SOL Ø15,6 RB2537	Ağırlık : 0,565 kg / 1.246 lb Konik Ölçüsü : Ø15,6 Bağlantı Delik Çapı : Ø10,5 Aşık Dış Çapı : M12X1,5	1K0407365B, 1K0407365C 1K0407365E, 5Q0407365A
	VW2008 ROTBAŞI ÖN SAĞ RD0342	Ağırlık : 0,412 kg / 0.908 lb Uzunluk : 95 mm / 3.74 inch Gövde Dış Çapı : M16X1,5 Aşık Dış Çapı : M12X1,5 Aşık Konik Çapı : Ø12,7	1K0423812A, 1K0423812C 1K0423812E, 1K0423812G 1K0423812J, 1K0423812K 1KD423812A
	VW2009 ROTBAŞI ÖN SOL RD0343	Ağırlık : 0,412 kg / 0.908 lb Uzunluk : 95 mm / 3.74 inch Gövde Dış Çapı : M16X1,5 Aşık Dış Çapı : M12X1,5 Aşık Konik Çapı : Ø13,5	1K0423811A, 1K0423811C 1K0423811E, 1K0423811G 1K0423811J, 1K0423811K 1KD423811A
	VW3009 ROTMİLİ SAĞ-SOL 310 RB2838	Ağırlık : 0,665 kg / 1.466 lb Uzunluk : 311 mm / 12.24 inch Gövde Dış Çapı : M16X1,5 Aşık Dış Çapı : M16X1,5	1K0423810A
	VW20083009 ROT TAKIMI ÖN AKS SAĞ RB288137	Ağırlık : 1,078 kg / 2.377 lb Rotbaşı : VW2008 Rotmilî : VW3009	

* Bu sayfada ve katalogdaki tüm araçların adları, markaları, modelleri, sembolleri, logoları, orijinal numaraları (oe) ve diğer üçüncü parti numaraları sadece referans amaçlı kullanılmaktadır.

GTI	MK5, A5		2006 - 2009
Resim	Ürün Kodu ve Açıklaması	Detay	OEM
	VW20093009 ROT TAKIMI ÖN SOL RB288138	Ağırlık : 1,077 kg / 2.374 lb Rotbaşı : VW2009 Rotmili : VW3009	
	SK4005 Z ROT ÖM SAĞ-SOL L=335MM	Ağırlık : 0,322 kg / 0.710 lb Malzeme Türü : Metal Uzunluk : 335 mm / 13.19 inch Aşık Diş Çapı : M12X1,5	5Q0411315B
	VW4014 Z ROT ÖN SAĞ-SOL METAL 335 RB2935	Ağırlık : 0,46 kg / 1.014 lb Malzeme Türü : Metal Uzunluk : 335 mm / 13.19 inch Aşık Diş Çapı : M12X1,5	1K0411315B, 1K0411315D 1K0411315J, 1K0411315K 1K0411315R, 5Q0411315A 5Q0411315B
	VW4015 Z ROT SOL VE SAĞ METAL RB2937	Ağırlık : 0,373 kg / 0.822 lb Malzeme Türü : Metal Uzunluk : 95,5 mm / 3.76 inch Aşık Diş Çapı : M10X1,5	1K0505465C, 1K0505465D 1K0505465H, 1K0505465J 1K0505465K
	VW4015K Z ROT SOL VE SAĞ METAL	Ağırlık : 0,373 kg / 0.822 lb Malzeme Türü : Metal Uzunluk : 95,5 mm / 3.76 inch Aşık Diş Çapı : M10X1,5	1K0505465C, 1K0505465D 1K0505465H, 1K0505465J 1K0505465K
	VW4016 Z ROT ARKA METAL 243 RD0945	Ağırlık : 0,384 kg / 0.847 lb Malzeme Türü : Metal Uzunluk : 241 mm / 9.49 inch Aşık Diş Çapı : M12X1,5	2K0505465B, 2K0505465C 2K0505465E
	AU6010 SALINCAK ÜST SOL VE SAĞ RA5155	Ağırlık : 1,298 kg / 2.862 lb Malzeme Türü : Sac Metal	1K0505323H, 1K0505323N
	SE9001 SALINCAK ALT SAĞ RA5150	Ağırlık : 1 kg / 2.205 lb Malzeme Türü : Sac Metal	1K0501530C
	SE9002 SALINCAK ALT SOL RA5151	Ağırlık : 1 kg / 2.205 lb Malzeme Türü : Sac Metal	1K0501529F
	SK9001 SALINCAK ARKA ALT	Ağırlık : 0,701 kg / 1.545 lb Malzeme Türü : Sac Metal	1K0501529J
	VW6016 SALINCAK ÖN SAĞ RD10227	Ağırlık : 4,543 kg / 10.016 lb Malzeme Türü : Sac Metal	1K0407152P, 1K0407152Q* 1K0407152Q











* Bu sayfada ve katalogdaki tüm araçların adları, markaları, modelleri, sembolleri, logoları, orjinal numaraları (oe) ve diğer üçüncü parti numaraları sadece referans amaçlı kullanılmaktadır.

GTI	MK5, A5		2006 - 2009
Resim	Ürün Kodu ve Açıklaması	Detay	OEM
	VW6016J SALINCAK ÖN ALT SAĞ S737	Ağırlık : 4,015 kg / 8.852 lb Malzeme Türü : Sac Metal	1K0407151P, 1K0407151Q 1K0407152P, 1K0407152Q
	VW6017 SALINCAK ÖN SOL RD10226	Ağırlık : 4,543 kg / 10.016 lb Malzeme Türü : Sac Metal	1K0407151M*, 1K0407151P 1K0407151Q*, 1K0407151Q
	VW6017J SALINCAK ÖN ALT SOL S738	Ağırlık : 4,015 kg / 8.852 lb Malzeme Türü : Sac Metal	1K0407151P, 1K0407151Q 1K0407152P, 1K0407152Q
	VW6018J SALINCAK ÖN SAĞ RB30211	Ağırlık : 4,232 kg / 9.330 lb Malzeme Türü : Döküm Çelik	1K0407152AC, 1K0407152M 1K0407152R
	VW6019J SALINCAK ÖN SOL RB30212	Ağırlık : 4,232 kg / 9.330 lb Malzeme Türü : Döküm Çelik	1K0407151AC, 1K0407151M 1K0407151R
	AU11014 SALINCAK VE DENGE KOLU BURCU ARKA SOL VE SAĞ	Şasi (Ön / Arka) : ARKA Yön : Sol Ve Sağ Ağırlık : 0.192 kg / 0.423 lb	1K0505543A
	AU11052 SALINCAK VE DENGE KOLU BURCU SOL VE SAĞ	Yön : Sol Ve Sağ Ağırlık : 0,178 kg / 0.392 lb	1K0505541B, 1K0505541C 1K0505541D
	SK11009 SALINCAK VE DENGE KOLU BURCU ARKA SOL VE SAĞ	Şasi (Ön / Arka) : ARKA Yön : Sol Ve Sağ Ağırlık : 0,176 kg / 0.388 lb	1K0501529J*
	SK11010 SALINCAK VE DENGE KOLU BURCU ARKA SOL VE SAĞ	Şasi (Ön / Arka) : ARKA Yön : Sol Ve Sağ Ağırlık : 0,196 kg / 0.432 lb Not : BÜYÜK	1K0501529J*
	VW11037 SALINCAK VE DENGE KOLU BURCU SOL VE SAĞ	Yön : Sol Ve Sağ Ağırlık : 0.11 kg / 0.243 lb	1K0505279A
	VW11042 SALINCAK VE DENGE KOLU BURCU ORTA SOL VE SAĞ	Yön : Orta Sol Ve Sağ Ağırlık : 0,182 kg / 0.401 lb	1K0407182, 5Q0407182



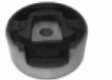

* Bu sayfada ve katalogdaki tüm araçların adları, markaları, modelleri, sembolleri, logoları, orjinal numaraları (oe) ve diğer üçüncü parti numaraları sadece referans amaçlı kullanılmaktadır.

GTI	MK5, A5		2006 - 2009
Resim	Ürün Kodu ve Açıklaması	Detay	OEM
	VW11043 SALINCAK VE DENGE KOLU BURCU SAĞ B22141	Yön : Sağ Diğer Taraf : VW11044 Ağırlık : 0,659 kg / 1.453 lb	1K0199232G, 1K0199232H 1K0199232J
	VW11043B SALINCAK VE DENGE KOLU BURCU SAĞ	Yön : Sağ Diğer Taraf : VW11044B Ağırlık : 0,659 kg / 1.453 lb Not : İÇ BURÇSUZ	1K0199232G, 1K0199232H 1K0199232J
	VW11044 SALINCAK VE DENGE KOLU BURCU SOL B22142	Yön : Sol Diğer Taraf : VW11043 Ağırlık : 0,678 kg / 1.495 lb	1K0199231G, 1K0199231H 1K0199231J
	VW11044B SALINCAK VE DENGE KOLU BURCU SOL	Yön : Sol Diğer Taraf : VW11043B Ağırlık : 0,678 kg / 1.495 lb Not : İÇ BURÇSUZ	1K0199231G, 1K0199231H 1K0199231J
	VW11047 SALINCAK VE DENGE KOLU BURCU İÇ SOL VE SAĞ B37117	Yön : İç Sol Ve Sağ Ağırlık : 0,121 kg / 0.267 lb	1K0199231J, 1K0199231J-P 1K0407183E
	VW11051 SALINCAK VE DENGE KOLU BURCU SOL VE SAĞ	Yön : Sol Ve Sağ Ağırlık : 0.121 kg / 0.267 lb	6Q0407183, 6Q0407183A
	VW11055 SALINCAK VE DENGE KOLU BURCU İÇ SOL VE SAĞ	Yön : İç Sol Ve Sağ Ağırlık : 0.121 kg / 0.267 lb	1K0407183E, 8J0407183
	VW11056 SALINCAK VE DENGE KOLU BURCU ARKA SOL VE SAĞ	Şasi (Ön / Arka) : ARKA Yön : Sol Ve Sağ Ağırlık : 0.13 kg / 0.287 lb	1K0505203A, 1K0505323D 1K0505323G, 1K0505323H 1K0505323N, 5Q0505323C
	VW11180 Z-ROT BURCU ARKA	Şasi (Ön / Arka) : ARKA Ağırlık : 0.069 kg / 0.152 lb Uzunluk : VW4015 mm / 0.00 inch Aşık Diş Çapı : VW4015K	1K0505465C*, 1K0505465D* 1K0505465H*, 1K0505465J* 1K0505465K*
	VW12131 Z-ROT BURCU ARKA	Şasi (Ön / Arka) : ARKA Ağırlık : 0.084 kg / 0.185 lb	2K0505465B*, 2K0505465C* 2K0505465E*, 2K5505465A*
	VW12131K Z-ROT BURCU ARKA	Şasi (Ön / Arka) : ARKA Ağırlık : 0.168 kg / 0.370 lb	2K0505465B*, 2K0505465C* 2K0505465E*, 2K5505465A*

* Bu sayfada ve katalogdaki tüm araçların adları, markaları, modelleri, sembolleri, logoları, orjinal numaraları (oe) ve diğer üçüncü parti numaraları sadece referans amaçlı kullanılmaktadır.

GTI	MK5, A5		2006 - 2009
Resim	Ürün Kodu ve Açıklaması	Detay	OEM
	VW12020 VİRAJ DEMİR LASTİĞİ SOL VE SAĞ RUBBER	Şasi (Ön / Arka) : ÖN Yön : Sol Ve Sağ Ağırlık : 0.07 kg / 0.154 lb Malzeme Türü : Rubber Not : VİRAJ ORTA LASTİĞİ	8D0511327C
	VW12020K VİRAJ DEMİR LASTİĞİ SOL VE SAĞ RUBBER	Şasi (Ön / Arka) : ÖN Yön : Sol Ve Sağ Ağırlık : 0.14 kg / 0.309 lb Malzeme Türü : Rubber	8D0511327C*
	VW12137 VİRAJ DEMİR LASTİĞİ	Şasi (Ön / Arka) : ARKA Ağırlık : 0,070 kg / 0.154 lb Not : Ø17mm	1K0511327AQ
	VW12137K VİRAJ DEMİR LASTİĞİ	Şasi (Ön / Arka) : ARKA Ağırlık : 0,140 kg / 0.309 lb Not : KIT	1K0511327AQ
	VW12017 AMORTİSÖR TAKOZU SOL VE SAĞ AMORTİSÖR TAKOZU	Yön : Sol Ve Sağ Ağırlık : 0.847 kg / 1.867 lb Not : AMORTİSÖR TAKOZU	1K0412331B, 1K0412331C
	VW12109 AMORTİSÖR TAKOZU SOL VE SAĞ AMORTİSÖR RULMANI	Yön : Sol Ve Sağ Ağırlık : 0.26 kg / 0.573 lb Not : AMORTİSÖR RULMANI	6N0412249C, 6N0412249E
	VW12109K AMORTİSÖR TAKOZU SOL VE SAĞ 2 PCS	Yön : Sol Ve Sağ Ağırlık : 0.52 kg / 1.146 lb Not : 2 PCS	6N0412249C, 6N0412249E
	VW12025 MOTOR TAKOZU ALT SOL VE SAĞ MOTOR TAKOZU ALT	Yön : Alt Sol Ve Sağ Ağırlık : 0.25 kg / 0.551 lb Not : MOTOR TAKOZU ALT	1K0199867A, 1K0199867B 1K0199867Q
	VW12027 MOTOR TAKOZU SOL VE SAĞ MOTOR KULAĞI	Yön : Sol Ve Sağ Ağırlık : 2.02 kg / 4.453 lb Not : MOTOR KULAĞI	1K0199262, 1K0199262CN
	VW12029 MOTOR TAKOZU SOL VE SAĞ MOTOR TAKOZU	Yön : Sol Ve Sağ Ağırlık : 0.585 kg / 1.290 lb Not : Motor takozu	1K0199855AD, 1K0199855BA 1K0199855K
	VW12032 MOTOR TAKOZU SOL VE SAĞ MOTOR TAKOZU	Yön : Sol Ve Sağ Ağırlık : 0.64 kg / 1.411 lb Not : Motor takozu	1K0199855BB, 1K0199855L

* Bu sayfada ve katalogdaki tüm araçların adları, markaları, modelleri, sembolleri, logoları, orjinal numaraları (oe) ve diğer üçüncü parti numaraları sadece referans amaçlı kullanılmaktadır.





GTI	MK5, A5		2006 - 2009
Resim	Ürün Kodu ve Açıklaması	Detay	OEM
	VW12033 MOTOR TAKOZU SOL VE SAĞ MOTOR TAKOZU	Yön : Sol Ve Sağ Ağırlık : 1.84 kg / 4.057 lb Not : Motor takozu	1K0199555AQ, 1K0199555AR 1K0199555Q, 1K0199555R 3C0199555AA, 3C0199555R
	VW12034 MOTOR TAKOZU SOL VE SAĞ MOTOR TAKOZU	Yön : Sol Ve Sağ Ağırlık : 1.9 kg / 4.189 lb Not : Motor takozu	1K0199555BA, 1K0199555BB 1K0199555L, 1K0199555M 1L0199555L
	VW12073 MOTOR TAKOZU SOL VE SAĞ MOTOR TAKOZU	Yön : Sol Ve Sağ Ağırlık : 1.643 kg / 3.622 lb Not : MOTOR TAKOZU	1K0199262AC, 1K0199262AL 1K0199262L
	VW12076 MOTOR TAKOZU SOL VE SAĞ MOTOR TAKOZU	Yön : Sol Ve Sağ Ağırlık : 1.97 kg / 4.343 lb Not : MOTOR TAKOZU	1K0199262AF, 1K0199262AT 1K0199262BB
	VW12077 MOTOR TAKOZU SOL VE SAĞ MOTOR TAKOZU	Yön : Sol Ve Sağ Ağırlık : 1.95 kg / 4.299 lb Not : MOTOR TAKOZU	1K0199262CG, 1K0199262CP
	VW12082 MOTOR TAKOZU SOL VE SAĞ MOTOR TAKOZU	Yön : Sol Ve Sağ Ağırlık : 2.05 kg / 4.519 lb Not : MOTOR TAKOZU	1K0199262AK, 1K0199262K
	VW12094 MOTOR TAKOZU SOL VE SAĞ MOTOR TAKOZU	Yön : Sol Ve Sağ Ağırlık : 1.872 kg / 4.127 lb Not : MOTOR TAKOZU	1K0199555N
	VW12097 MOTOR TAKOZU SOL VE SAĞ MOTOR TAKOZU	Yön : Sol Ve Sağ Ağırlık : 0.251 kg / 0.553 lb Not : MOTOR TAKOZU	1K0199868, 1K0199868A 1K0199868C, 1K0199868P 1K0199868Q
	VW12110 MOTOR TAKOZU SOL VE SAĞ MOTOR TAKOZU	Yön : Sol Ve Sağ Ağırlık : 1.918 kg / 4.228 lb Not : MOTOR TAKOZU	1K0199262AB, 1K0199262AM 1K0199262M
	VW12106 ŞANZUMAN TAKOZU SOL ŞANZUMAN TAKOZU SOL	Yön : Sol Ağırlık : 1.95 kg / 4.299 lb Not : ŞANZUMAN TAKOZU SOL	1K0199555AT, 1K0199555T
	VW12038 SÜSPANSİYON TAKOZU SOL VE SAĞ SUS. ARA YATAK TAKOZ ARKA	Yön : Sol Ve Sağ Ağırlık : 0.12 kg / 0.265 lb Not : SUS. ARA YATAK TAKOZ ARKA	3C0 511 359, 3C0511359

* Bu sayfada ve katalogdaki tüm araçların adları, markaları, modelleri, sembolleri, logoları, orjinal numaraları (oe) ve diğer üçüncü parti numaraları sadece referans amaçlı kullanılmaktadır.

GTI MK5, A5 2006 - 2009

Resim	Ürün Kodu ve Açıklaması	Detay	OEM
	VW12051 SÜSPANSİYON TAKOZU SOL VE SAĞ LASTİK DAYANAK SUSPENSİYON	Yön : Sol Ve Sağ Ağırlık : 0.045 kg / 0.099 lb Not : LASTİK DAYANAK SUSPENSİYON	1K0412303B
	VW12086 RADYATÖR TAKOZU SOL VE SAĞ RADYATÖR ÜST LASTİĞİ	Yön : Sol Ve Sağ Ağırlık : 0.024 kg / 0.053 lb Not : RADYATÖR ÜST LASTİĞİ	1K0121367F
	VW13006 DİREKSİYON KÖRÜĞÜ	Ağırlık : 0.145 kg / 0.320 lb	1K0423831A, 5C0423831
	VW13006K DİREKSİYON KÖRÜĞÜ SOL VE SAĞ 2 PİECES	Ağırlık : 0.29 kg / 0.639 lb	1K0423831A, 5C0423831
	VW14003 AKS KÖRÜĞÜ +KELEPÇE+YAĞ. DIŞ	Ağırlık : 0.25 kg / 0.551 lb	1K0 498 203, 1K0498203
	VW14011 AKS KÖRÜĞÜ +KELEPÇE+YAĞ. İÇ	Ağırlık : 0.236 kg / 0.520 lb	1K0498201D

ID.3 I E11 2020 -

Resim	Ürün Kodu ve Açıklaması	Detay	OEM
	VW1046 ROTİL ALT	Ağırlık : 0,615 kg / 1.356 lb	1EA407365A
	VW2037 ROTBAŞI SOL VE SAĞ 124	Ağırlık : 0,525 kg / 1.157 lb Uzunluk : 124 mm / 4.88 inch	1EA423811B
	VW3028 ROTMİLİ ÖN	Ağırlık : 0,875 kg / 1.929 lb Uzunluk : 405 mm / 15.94 inch	1EA423810B
	VW4040 Z ROT ÖN	Ağırlık : 0,475 kg / 1.047 lb Uzunluk : 338 mm / 13.31 inch	1EA411315C

* Bu sayfada ve katalogdaki tüm araçların adları, markaları, modelleri, sembolleri, logoları, orjinal numaraları (oe) ve diğer üçüncü parti numaraları sadece referans amaçlı kullanılmaktadır.

ID.3 **I E11** **2020 -**





Resim	Ürün Kodu ve Açıklaması	Detay	OEM
	VW4041 Z ROT ARKA SAĞ PLASTİK	Ağırlık : 0,245 kg / 0.540 lb Malzeme Türü : Plastik Uzunluk : 214 mm / 8.43 inch	1EA505466
	VW4042 Z ROT ARKA SOL PLASTİK	Ağırlık : 0,245 kg / 0.540 lb Malzeme Türü : Plastik Uzunluk : 214 mm / 8.43 inch	1EA505465
	VW6075 SALINCAK VE DENG KOLU ÖN ALT SAĞ SAC LEVHA	Ağırlık : 3,835 kg / 8.455 lb Malzeme Türü : Sac Metal	1EA407152B
	VW6075J SALINCAK VE DENG KOLU ÖN ALT SAĞ SAC LEVHA	Ağırlık : 3,195 kg / 7.044 lb Malzeme Türü : Sac Metal	1EA407152B*
	VW6076 SALINCAK VE DENG KOLU ÖN ALT SOL SAC LEVHA	Ağırlık : 3,835 kg / 8.455 lb Malzeme Türü : Sac Metal	1EA407151B
	VW6076J SALINCAK VE DENG KOLU ÖN ALT SOL SAC LEVHA	Ağırlık : 3,195 kg / 7.044 lb Malzeme Türü : Sac Metal	1EA407151B*
	VW11059 SALINCAK VE DENG KOLU BURCU ÖN ALT İÇ	Şasi (Ön / Arka) : ÖN Yön : Alt İç Ağırlık : 0,325 kg / 0.717 lb	1EA407151B*, 1EA407152B*
	VW11060 SALINCAK VE DENG KOLU BURCU ÖN ALT DIŞ	Şasi (Ön / Arka) : ÖN Yön : Alt Dış Ağırlık : 0,365 kg / 0.805 lb	1EA407151B*, 1EA407152B*

ID.4 **I E21** **2021 -**



Resim	Ürün Kodu ve Açıklaması	Detay	OEM
	VW1046 ROTİL ALT	Ağırlık : 0,615 kg / 1.356 lb	1EA407365A
	VW2037 ROTBAŞI SOL VE SAĞ 124	Ağırlık : 0,525 kg / 1.157 lb Uzunluk : 124 mm / 4.88 inch	1EA423811B

* Bu sayfada ve katalogdaki tüm araçların adları, markaları, modelleri, sembolleri, logoları, orjinal numaraları (oe) ve diğer üçüncü parti numaraları sadece referans amaçlı kullanılmaktadır.

ID.4 I E21 2021 -

Resim	Ürün Kodu ve Açıklaması	Detay	OEM
	VW3029 ROTMİLİ ÖN	Ağırlık : 0,915 kg / 2.017 lb Uzunluk : 433 mm / 17.05 inch	1EA423810C
	VW4040 Z ROT ÖN	Ağırlık : 0,475 kg / 1.047 lb Uzunluk : 338 mm / 13.31 inch	1EA411315C
	VW4041 Z ROT ARKA SAĞ PLASTİK	Ağırlık : 0,245 kg / 0.540 lb Malzeme Türü : Plastik Uzunluk : 214 mm / 8.43 inch	1EA505466
	VW4042 Z ROT ARKA SOL PLASTİK	Ağırlık : 0,245 kg / 0.540 lb Malzeme Türü : Plastik Uzunluk : 214 mm / 8.43 inch	1EA505465

ID.5 I E39 2022 -



Resim	Ürün Kodu ve Açıklaması	Detay	OEM
	VW3029 ROTMİLİ ÖN	Ağırlık : 0,915 kg / 2.017 lb Uzunluk : 433 mm / 17.05 inch	1EA423810C
	VW4041 Z ROT ARKA SAĞ PLASTİK	Ağırlık : 0,245 kg / 0.540 lb Malzeme Türü : Plastik Uzunluk : 214 mm / 8.43 inch	1EA505466
	VW4042 Z ROT ARKA SOL PLASTİK	Ağırlık : 0,245 kg / 0.540 lb Malzeme Türü : Plastik Uzunluk : 214 mm / 8.43 inch	1EA505465

JETTA MK1, A1 1974 - 1984

Resim	Ürün Kodu ve Açıklaması	Detay	OEM
	VW1005 ROTİL ALT SOL VE SAĞ RD0512	Ağırlık : 0,346 kg / 0.763 lb Bağlantı Delik Çapı : Ø7,5	171407365C, 171407365D
	VW1006 ROTİL SAĞ RD0513	Ağırlık : 0,35 kg / 0.772 lb Bağlantı Delik Çapı : Ø7,5	171407365F, 171407365G









* Bu sayfada ve katalogdaki tüm araçların adları, markaları, modelleri, sembolleri, logoları, orjinal numaraları (oe) ve diğer üçüncü parti numaraları sadece referans amaçlı kullanılmaktadır.

JETTA
MK1, A1
1974 - 1984

Resim	Ürün Kodu ve Açıklaması	Detay	OEM
	VW2003 ROTBAŞI SAĞ-SOL RD0339	Ağırlık : 0,3 kg / 0.661 lb Uzunluk : 79 mm / 3.11 inch Gövde Diş Çapı : M14X1,5 Aşık Diş Çapı : M12X1,5 Aşık Konik Çapı : Ø12,3	171419811, 171419811A 171419812, 251419811 32111116463, 477419811 477419815, 94434733300
	VW3002 ROTMİLİ RD0811	Ağırlık : 0,665 kg / 1.466 lb Uzunluk : 342 mm / 13.46 inch Gövde Diş Çapı : M22X1,5 Aşık Diş Çapı : M14X1,5	171419821, 171419821A
	VW3019 ROTMİLİ ÖN SAĞ - SOL	Ağırlık : 0,55 kg / 1.213 lb Gövde Diş Çapı : M14X1,5 RHT	175422821
	VW20033002 ROT TAKIMI SOL VE SAĞ	Ağırlık : 0,963 kg / 2.123 lb Rotbaşı : VW2003 Rotmilî : VW3002	171 419 804, 171419804
	VW20033019 ROT TAKIMI ÖN AKS RD088145	Ağırlık : 0,85 kg / 1.874 lb Rotbaşı : VW2003 Rotmilî : VW3019	155422803, 155422803A 175422803
	VW6001 SALINCAK ÖN ALT SAĞ	Ağırlık : 3,652 kg / 8.051 lb Malzeme Türü : Sac Metal	171407153D
	VW6001J SALINCAK ÖN ALT	Ağırlık : 2,236 kg / 4.930 lb Malzeme Türü : Sac Metal	171407153D
	VW6002 SALINCAK ÖN ALT SOL RD1047	Ağırlık : 2,668 kg / 5.882 lb Malzeme Türü : Sac Metal	171407153D
	VW11004 SALINCAK VE DENGE KOLU BURCU SOL VE SAĞ B40112	Yön : Sol Ve Sağ Ağırlık : 0,121 kg / 0.267 lb	171407181, 171407181A
	VW11005 SALINCAK VE DENGE KOLU BURCU ORTA SOL VE SAĞ B40113	Yön : Orta Sol Ve Sağ Ağırlık : 0,087 kg / 0.192 lb	171407182D, 171407182E
	VW12004 AMORTİSÖR TAKOĞU SOL VE SAĞ AMORTİSOR TABLASI	Yön : Sol Ve Sağ Ağırlık : 0,786 kg / 1.733 lb Not : AMORTİSOR TABLASI	171412329, 171412329A

* Bu sayfada ve katalogdaki tüm araçların adları, markaları, modelleri, sembolleri, logoları, orijinal numaraları (oe) ve diğer üçüncü parti numaraları sadece referans amaçlı kullanılmaktadır.

JETTA
MK1, A1
1974 - 1984











Resim	Ürün Kodu ve Açıklaması	Detay	OEM
	VW12009 MOTOR TAKOZU SOL VE SAĞ MOTOR TAKOZU	Yön : Sol Ve Sağ Ağırlık : 0,288 kg / 0.635 lb Not : MOTOR TAKOZU	171199214D, 171399113D
	VW12091 MOTOR TAKOZU SOL VE SAĞ MOTOR TAKOZU	Yön : Sol Ve Sağ Ağırlık : 0,289 kg / 0.637 lb Not : MOTOR TAKOZU	171199214G
	VW12003 SÜSPANSİYON TAKOZU SOL VE SAĞ AMARTİSÖR TAKOZU ARKA	Yön : Sol Ve Sağ Ağırlık : 0,076 kg / 0.168 lb Not : AMARTİSÖR TAKOZU ARKA	171512131B
	VW12089 SÜSPANSİYON TAKOZU SOL VE SAĞ SÜSPANSİYON TAKOZU	Yön : Sol Ve Sağ Ağırlık : 0.15 kg / 0.331 lb Not : SÜSPANSİYON TAKOZU	191412303A, 357412303E
	AU12012 EGSOZ TAKOZU ÖN SOL VE SAĞ EGSOZ LASTİĞİ	Şasi (Ön / Arka) : ÖN Yön : Sol Ve Sağ Ağırlık : 0.034 kg / 0.075 lb Not : EGSOZ LASTİĞİ	191253147B, 4A0253147A
	VW13008 DİREKSİYON KÖRÜĞÜ	Ağırlık : 0.225 kg / 0.496 lb	1H0422831B
	VW13010 DİREKSİYON KÖRÜĞÜ ÖN	Ağırlık : 0,124 kg / 0.273 lb	191422831
	VW14013 AKS KÖRÜĞÜ +KELEPÇE+YAĞ. YAĞ+KELEPÇE	Ağırlık : 0.156 kg / 0.344 lb	113501149, 171407283A
	VW14014 AKS KÖRÜĞÜ +KELEPÇE+YAĞ. YAĞ+KELEPÇE	Ağırlık : 0.28 kg / 0.617 lb	191498203C, 71498203

JETTA
MK2, A2
1983 - 1992

Resim	Ürün Kodu ve Açıklaması	Detay	OEM
	VW1011 ROTİL D= Ø17	Ağırlık : 0,39 kg / 0.860 lb Bağlantı Delik Çapı : Ø8,5	191407365, 191407365B

* Bu sayfada ve katalogdaki tüm araçların adları, markaları, modelleri, sembolleri, logoları, orjinal numaraları (oe) ve diğer üçüncü parti numaraları sadece referans amaçlı kullanılmaktadır.

JETTA
MK2, A2
1983 - 1992

Resim	Ürün Kodu ve Açıklaması	Detay	OEM
	VW1011K ROTİL ALT SAĞ-SOL Ø17 RD0514	Ağırlık : 0,435 kg / 0.959 lb Bağlantı Delik Çapı : Ø8,5	191.407.365F, 191407365 191407365B*, 191407365F
	VW1012 ROTİL ALT SOL VE SAĞ	Ağırlık : 0,353 kg / 0.778 lb Bağlantı Delik Çapı : Ø8,5	357407365, 357407365A
	VW1012K ROTİL ALT SAĞ-SOL 19 RD0515	Ağırlık : 0,445 kg / 0.981 lb Bağlantı Delik Çapı : Ø8,5	357407365, 357407365A* 357407365A, 357407365S 357407365-S1
	VW2006 ROTBAŞI SAĞ RD0312	Ağırlık : 0,3 kg / 0.661 lb Uzunluk : 76 mm / 2.99 inch Gövde Diş Çapı : M14X1,5 Aşık Diş Çapı : M12X1,5 Aşık Konik Çapı : Ø12,7	191419812, 22190091617 6N0419812, 6N0422812 XA2087
	VW2007 ROTBAŞI SOL RD0311	Ağırlık : 0,3 kg / 0.661 lb Uzunluk : 76 mm / 2.99 inch Gövde Diş Çapı : M14X1,5 Aşık Diş Çapı : M12X1,5 Aşık Konik Çapı : Ø12,7	191419811, 22190090617 6N0419811, 6N0422811 XA2084
	VW3003 ROTMİLİ SAĞ-SOL RD0817	Ağırlık : 0,678 kg / 1.495 lb Uzunluk : 340 mm / 13.39 inch Gövde Diş Çapı : M22X1,5 Aşık Diş Çapı : M14X1,5	191419721, 191419803 191419803-PART, 191419804* 191419804, 191419807A 191419821
	VW3004 ROTMİLİ ÖN SAĞ - SOL 338 RD0887	Ağırlık : 0,605 kg / 1.334 lb Uzunluk : 338 mm / 13.31 inch Gövde Diş Çapı : M14X1,5 Aşık Diş Çapı : M14X1,5	191407153, 191422721 191422803A, 191422804A 191422807, 191422807A 191422821, 191422821A 6K0422821
	VW20063003 ROT TAKIMI SAĞ RD088116	Ağırlık : 0,984 kg / 2.169 lb Rotbaşı : VW2006 Rotmilî : VW3003	191419804, 191419804A
	VW20063004 ROT TAKIMI ÖN AKS SAĞ	Ağırlık : 0,991 kg / 2.185 lb Rotbaşı : VW2006 Rotmilî : VW3004	191422804A
	VW20073003 ROT TAKIMI SOL RD088115	Ağırlık : 0,978 kg / 2.156 lb Rotbaşı : VW2007 Rotmilî : VW3003	191419803, 191419803A
	VW20073004 ROT TAKIMI SOL RD088118	Ağırlık : 0,991 kg / 2.185 lb Rotbaşı : VW2007 Rotmilî : VW3004	191422803, 191422803A

* Bu sayfada ve katalogdaki tüm araçların adları, markaları, modelleri, sembolleri, logoları, orijinal numaraları (oe) ve diğer üçüncü parti numaraları sadece referans amaçlı kullanılmaktadır.

JETTA
MK2, A2
1983 - 1992

Resim	Ürün Kodu ve Açıklaması	Detay	OEM
	VW4004 Z ROT ÖN SAĞ - SOL KOMPLE RD0942	Ağırlık : 0,189 kg / 0.417 lb Malzeme Türü : Komple Uzunluk : 75 mm / 2.95 inch	191411315, 191411315B 191411315BKIT, 191411315BS
	VW4029 Z ROT ÖN SAĞ - SOL	Ağırlık : 0,166 kg / 0.366 lb Uzunluk : 77 mm / 3.03 inch	191411315B
	VW6004 SALINCAK ÖN SAĞ	Ağırlık : 3,21 kg / 7.077 lb Malzeme Türü : Sac Metal	191407151A
	VW60046005K SALINCAK ÖN	Ağırlık : 3,8 kg / 8.378 lb Malzeme Türü : Sac Metal	
	VW6004J SALINCAK ÖN RD1103	Ağırlık : 2,605 kg / 5.743 lb Malzeme Türü : Sac Metal	191.407.151B, 191407151A 191407151B
	VW6005 SALINCAK ÖN SOL	Ağırlık : 3,21 kg / 7.077 lb Malzeme Türü : Sac Metal	192407151A
	VW6006 SALINCAK ÖN SAĞ RD1019	Ağırlık : 3,166 kg / 6.980 lb Malzeme Türü : Sac Metal	191407151B, 191407175 191411315B, 191411331 357407365A, 6N0411329 N0111849, N10127702
	VW60066007K SALINCAK ÖN	Ağırlık : 3,3 kg / 7.275 lb Malzeme Türü : Sac Metal	
	VW600674008K SALINCAK ÖN	Ağırlık : 3,466 kg / 7.641 lb Malzeme Türü : Sac Metal	
	VW6007 SALINCAK ÖN SOL RD1029	Ağırlık : 3,088 kg / 6.808 lb Malzeme Türü : Sac Metal	191407151A
	AU11005 SALINCAK VE DENGE KOLU BURCU ÖN ORTA SOL VE SAĞ B40115	Şasi (Ön / Arka) : ÖN Yön : Orta Sol Ve Sağ Ağırlık : 0,111 kg / 0.245 lb Not : VW6014 - VW60614J	191407182, 357407182 357407182F

* Bu sayfada ve katalogdaki tüm araçların adları, markaları, modelleri, sembolleri, logoları, orjinal numaraları (oe) ve diğer üçüncü parti numaraları sadece referans amaçlı kullanılmaktadır.

JETTA
MK2, A2
1983 - 1992

Resim	Ürün Kodu ve Açıklaması	Detay	OEM
	VW11001 SALINCAK VE DENGE KOLU BURCU SOL VE SAĐ B40114	Yön : Sol Ve SaĐ Ağırlık : 0.141 kg / 0.311 lb	191407181D, 191407181E 357407181
	VW11024 SALINCAK VE DENGE KOLU BURCU SOL VE SAĐ	Yön : Sol Ve SaĐ Ağırlık : 0,204 kg / 0.450 lb	191407181A, 191407181B
	VW11840 BURÇ	Yön : Sol Ve SaĐ Ağırlık : 0,149 kg / 0.328 lb	357407181
	VW12060 TORSİYON BURCU SOL VE SAĐ	Yön : Sol Ve SaĐ Ağırlık : 0,459 kg / 1.012 lb	191501541
	VW12037 VİRAJ DEMİR LASTİĐİ SOL VE SAĐ RUBBER	Şasi (Ön / Arka) : ÖN Yön : Sol Ve SaĐ Ağırlık : 0.11 kg / 0.243 lb Malzeme Türü : Rubber Not : VİRAJ DEMİR LASTİĐİ ÖN	191411314
	VW12037K VİRAJ DEMİR LASTİĐİ SOL VE SAĐ RUBBER	Şasi (Ön / Arka) : ÖN Yön : Sol Ve SaĐ Ağırlık : 0.22 kg / 0.485 lb Malzeme Türü : Rubber	191411314*
	VW12053 VİRAJ DEMİR LASTİĐİ SOL VE SAĐ RUBBER	Şasi (Ön / Arka) : ÖN Yön : Sol Ve SaĐ Ağırlık : 0.06 kg / 0.132 lb Malzeme Türü : Rubber Not : VİRAJ LASTİĐİ	1H0411314
	VW12053K VİRAJ DEMİR LASTİĐİ SOL VE SAĐ RUBBER	Şasi (Ön / Arka) : ÖN Yön : Sol Ve SaĐ Ağırlık : 0.12 kg / 0.265 lb Malzeme Türü : Rubber	1H0411314*
	VW12111 VİRAJ DEMİR LASTİĐİ SOL VE SAĐ RUBBER	Şasi (Ön / Arka) : ÖN Yön : Sol Ve SaĐ Ağırlık : 0.015 kg / 0.033 lb Malzeme Türü : Rubber Not : VİRAJ LASTİĐİ	191411329, 6N0411329
	VW12111K VİRAJ DEMİR LASTİĐİ SOL VE SAĐ RUBBER	Şasi (Ön / Arka) : ÖN Yön : Sol Ve SaĐ Ağırlık : 0.03 kg / 0.066 lb Malzeme Türü : Rubber	191411329*, 6N0411329*
	VW12001 AMORTİSÖR TAKOZU SOL VE SAĐ AMARTİSÖR TAKOZU	Yön : Sol Ve SaĐ Ağırlık : 0.644 kg / 1.420 lb Not : AMARTİSÖR TAKOZU	176412329, 191412329 191412331

* Bu sayfada ve katalogdaki tüm araçların adları, markaları, modelleri, sembolleri, logoları, orjinal numaraları (oe) ve diĐer üçüncü parti numaraları sadece referans amaçlı kullanılmaktadır.

JETTA
MK2, A2
1983 - 1992

Resim	Ürün Kodu ve Açıklaması	Detay	OEM
	VW12005 AMORTİSÖR TAKOZU SOL VE SAĞ AMORTİSÖR ÜST TAKOZU	Yön : Sol Ve Sağ Ağırlık : 0.1 kg / 0.220 lb Not : AMORTİSÖR ÜST TAKOZU	191512333
	VW12065 AMORTİSÖR TAKOZU SOL VE SAĞ AMORTİSÖR KEPİ	Yön : Sol Ve Sağ Ağırlık : 0.377 kg / 0.831 lb Not : AMORTİSÖR KEPİ	191 512 113, 191512113
	VW12065K AMORTİSÖR TAKOZU ÖN SOL VE SAĞ 2 PCS	Şasi (Ön / Arka) : ÖN Yön : Sol Ve Sağ Ağırlık : 0.758 kg / 1.671 lb Not : 2 PCS	191512113
	VW12002 MOTOR TAKOZU SOL VE SAĞ ŞANZUMAN TAKOZU	Yön : Sol Ve Sağ Ağırlık : 0.68 kg / 1.499 lb Not : ŞANZUMAN TAKOZU	191199402, 191199402A 191199402AC, 191199402B 191199402C
	VW12007 MOTOR TAKOZU SAĞ MOTOR TAKOZU SAĞ	Yön : Sağ Ağırlık : 1,193 kg / 2.630 lb Not : MOTOR TAKOZU SAĞ	91199262A
	VW12095 MOTOR TAKOZU SOL VE SAĞ MOTOR TAKOZU	Yön : Sol Ve Sağ Ağırlık : 1,389 kg / 3.062 lb Not : MOTOR TAKOZU	191199272, 191199272A 191199273, 191199279B 191199279C, 191199279D 357199279C
	VW12088 SÜSPANSİYON TAKOZU SOL VE SAĞ SÜSPANSİYON TAKOZU ARKA	Yön : Sol Ve Sağ Ağırlık : 0.11 kg / 0.243 lb Not : SÜSPANSİYON TAKOZU ARKA	191512131B
	VW12089 SÜSPANSİYON TAKOZU SOL VE SAĞ SÜSPANSİYON TAKOZU	Yön : Sol Ve Sağ Ağırlık : 0.15 kg / 0.331 lb Not : SÜSPANSİYON TAKOZU	191412303A, 357412303E
	AU12012 EGSOZ TAKOZU ÖN SOL VE SAĞ EGSOZ LASTİĞİ	Şasi (Ön / Arka) : ÖN Yön : Sol Ve Sağ Ağırlık : 0.034 kg / 0.075 lb Not : EGSOZ LASTİĞİ	191253147B, 4A0253147A
	VW13008 DİREKSİYON KÖRÜĞÜ	Ağırlık : 0.225 kg / 0.496 lb	1H0422831B
	VW13010 DİREKSİYON KÖRÜĞÜ ÖN	Ağırlık : 0,124 kg / 0.273 lb	191422831

* Bu sayfada ve katalogdaki tüm araçların adları, markaları, modelleri, sembolleri, logoları, orjinal numaraları (oe) ve diğer üçüncü parti numaraları sadece referans amaçlı kullanılmaktadır.

JETTA MK2, A2 1983 - 1992











Resim	Ürün Kodu ve Açıklaması	Detay	OEM
	OP14003 AKS KÖRÜĞÜ +KELEPÇE+YAĞ. AKS KÖRÜĞÜ DIŞ	Ağırlık : 0.2 kg / 0.441 lb	1603180
	RN14006 AKS KÖRÜĞÜ +KELEPÇE+YAĞ. DIŞ	Ağırlık : 0.2 kg / 0.441 lb	1603180, 1603204 16410170470106*, 16500170470106* 1H0498203, 271648 271649, 321498203A 431498203C, 443498203D
	VW14013 AKS KÖRÜĞÜ +KELEPÇE+YAĞ. YAĞ+KELEPÇE	Ağırlık : 0.156 kg / 0.344 lb	113501149, 171407283A
	VW14014 AKS KÖRÜĞÜ +KELEPÇE+YAĞ. YAĞ+KELEPÇE	Ağırlık : 0.28 kg / 0.617 lb	191498203C, 71498203

JETTA MK3, A3 1991 - 1998

Resim	Ürün Kodu ve Açıklaması	Detay	OEM
	VW1012 ROTİL ALT SOL VE SAĞ	Ağırlık : 0,353 kg / 0.778 lb Bağlantı Delik Çapı : Ø8,5	357407365, 357407365A
	VW1012K ROTİL ALT SAĞ-SOL 19 RD0515	Ağırlık : 0,445 kg / 0.981 lb Bağlantı Delik Çapı : Ø8,5	357407365, 357407365A* 357407365A, 357407365S 357407365-S1
	VW1013 ROTİL ÖN ALT Ø16,5 RD0519	Ağırlık : 0,415 kg / 0.915 lb Konik Ölçüsü : Ø16,5 Bağlantı Delik Çapı : Ø8,5 Aşık Diş Çapı : M12X1,5	1H0407365
	VW1013K ROTİL	Ağırlık : 0,495 kg / 1.091 lb Konik Ölçüsü : Ø16,5 Bağlantı Delik Çapı : Ø8,5 Aşık Diş Çapı : M12X1,5	1H0407365*, 1H0407365
	VW2006 ROTBAŞI SAĞ RD0312	Ağırlık : 0,3 kg / 0.661 lb Uzunluk : 76 mm / 2.99 inch Gövde Diş Çapı : M14X1,5 Aşık Diş Çapı : M12X1,5 Aşık Konik Çapı : Ø12,7	191419812, 22190091617 6N0419812, 6N0422812 XA2087
	VW2007 ROTBAŞI SOL RD0311	Ağırlık : 0,3 kg / 0.661 lb Uzunluk : 76 mm / 2.99 inch Gövde Diş Çapı : M14X1,5 Aşık Diş Çapı : M12X1,5 Aşık Konik Çapı : Ø12,7	191419811, 22190090617 6N0419811, 6N0422811 XA2084

* Bu sayfada ve katalogdaki tüm araçların adları, markaları, modelleri, sembolleri, logoları, orjinal numaraları (oe) ve diğer üçüncü parti numaraları sadece referans amaçlı kullanılmaktadır.

JETTA
MK3, A3
1991 - 1998

Resim	Ürün Kodu ve Açıklaması	Detay	OEM
	VW3007 ROTMİLİ ÖN SAĞ - SOL 369 RD0823	Ağırlık : 0,703 kg / 1.550 lb Uzunluk : 369 mm / 14.53 inch Gövde Diş Çapı : M22X1,5 Aşık Diş Çapı : M14X1,5	1H0419821
	VW3008 ROTMİLİ SAĞ-SOL 371 RD0826	Ağırlık : 0,652 kg / 1.437 lb Uzunluk : 371 mm / 14.61 inch Gövde Diş Çapı : M14X1,5 Aşık Diş Çapı : M14X1,5	1H0422803, 1H0422804 1H0422821, 803419811
	VW20063007 ROT TAKIMI ÖN AKS SAĞ RD088121	Ağırlık : 1,003 kg / 2.211 lb Rotbaşı : VW2006 Rotmili : VW3007	1H0419804, 1H0419804A
	VW20063008 ROT TAKIMI ÖN AKS SAĞ RD088125	Ağırlık : 0,947 kg / 2.088 lb Rotbaşı : VW2006 Rotmili : VW3008	1H0422804, 1H0422804A
	VW20073007 ROT TAKIMI ÖN AKS SOL RD088122	Ağırlık : 1,006 kg / 2.218 lb Rotbaşı : VW2007 Rotmili : VW3007	1H0419803, 357419803A
	VW20073008 ROT TAKIMI SOL RD088124	Ağırlık : 0,956 kg / 2.108 lb Rotbaşı : VW2007 Rotmili : VW3008	1H0422803
	VW4008 Z ROT ÖN SAĞ - SOL METAL RD0923	Ağırlık : 0,166 kg / 0.366 lb Malzeme Türü : Metal Uzunluk : 77 mm / 3.03 inch Aşık Diş Çapı : M8X1,25	191411315A, 191411315B 191411315BK
	VW4009 Z ROT ÖN SAĞ-SOL METAL 51 RD0911	Ağırlık : 0,15 kg / 0.331 lb Malzeme Türü : Metal Uzunluk : 51 mm / 2.01 inch Aşık Diş Çapı : M10X1,5	535411315
	VW4023 Z ROT ÖN SAĞ - SOL	Ağırlık : 0,195 kg / 0.430 lb Uzunluk : 78 mm / 3.07 inch Aşık Diş Çapı : M12X1,5	191411315A, 191411327
	VW6012 SALINCAK ALT SAĞ S725	Ağırlık : 2,754 kg / 6.072 lb Malzeme Türü : Sac Metal	191407153, 1H0407151
	VW60126013K SALINCAK ÖN	Ağırlık : 3.15 kg / 6.945 lb Malzeme Türü : Sac Metal	

* Bu sayfada ve katalogdaki tüm araçların adları, markaları, modelleri, sembolleri, logoları, orjinal numaraları (oe) ve diğer üçüncü parti numaraları sadece referans amaçlı kullanılmaktadır.

JETTA
MK3, A3
1991 - 1998

Resim	Ürün Kodu ve Açıklaması	Detay	OEM
	VW6012J SALINCAK ÖN SAĞ - SOL RD1104	Ağırlık : 2,32 kg / 5.115 lb Malzeme Türü : Sac Metal	1H0407151
	VW6013 SALINCAK ALT SOL S726	Ağırlık : 2,754 kg / 6.072 lb Malzeme Türü : Sac Metal	191407151A, 1H0407151 1H0407152
	VW6014 SALINCAK ÖN SAĞ RD1021	Ağırlık : 3,966 kg / 8.744 lb Malzeme Türü : Sac Metal	1H0407152*
	VW6014J SALINCAK ÖN SAĞ RD1106	Ağırlık : 3,35 kg / 7.385 lb Malzeme Türü : Sac Metal	1H0407152
	VW6015 SALINCAK ÖN SOL RD1022	Ağırlık : 3,674 kg / 8.100 lb Malzeme Türü : Sac Metal	1H0407151A *, 1H0407151A*
	VW6015J SALINCAK ÖN SOL RD1105	Ağırlık : 3,152 kg / 6.949 lb Malzeme Türü : Sac Metal	1H0.407.151A, 1H0407151 1H0407151A
	AU11005 SALINCAK VE DENGE KOLU BURCU ÖN ORTA SOL VE SAĞ B40115	Şasi (Ön / Arka) : ÖN Yön : Orta Sol Ve Sağ Ağırlık : 0,111 kg / 0.245 lb Not : VW6014 - VW60614J	191407182, 357407182 357407182F
	VW11001 SALINCAK VE DENGE KOLU BURCU SOL VE SAĞ B40114	Yön : Sol Ve Sağ Ağırlık : 0.141 kg / 0.311 lb	191407181D, 191407181E 357407181
	VW11036 SALINCAK VE DENGE KOLU BURCU SOL VE SAĞ	Yön : Sol Ve Sağ Ağırlık : 0.07 kg / 0.154 lb Not : BORUSU	191411315B, 4A0399413A
	VW11069 Z-ROT BURCU ÖN	Şasi (Ön / Arka) : ÖN Ağırlık : 0,035 kg / 0.077 lb Z Rot 1 : VW4009	535411315

* Bu sayfada ve katalogdaki tüm araçların adları, markaları, modelleri, sembolleri, logoları, orjinal numaraları (oe) ve diğer üçüncü parti numaraları sadece referans amaçlı kullanılmaktadır.

JETTA
MK4, A4
1999 - 2004

Resim	Ürün Kodu ve Açıklaması	Detay	OEM
	AU1013 ROTİL ÖN ALT SAĞ - SOL Ø15,5 RB2535	Ağırlık : 0,555 kg / 1.224 lb Konik Ölçüsü : Ø15,5 Bağlantı Delik Çapı : Ø10,7 Aşık Diş Çapı : M12X1,5	8N0.407.365A, 8N0.407.365B 8N0.407.365C, 8N0407365A 8N0407365B, 8N0407365C
	AU1014 ROTİL ALT SAĞ Ø15	Ağırlık : 0,35 kg / 0.772 lb Konik Ölçüsü : Ø15 Bağlantı Delik Çapı : Ø8,5 Aşık Diş Çapı : M12X1,25	1J0407366A, 1J0407366AS 1J0407366B, 1J0407366C 1J0407366D, 1J0407366H
	AU1014K ROTİL ÖN SAĞ Ø15 RB2530	Ağırlık : 0,5 kg / 1.102 lb Konik Ölçüsü : Ø15 Bağlantı Delik Çapı : Ø8,5 Aşık Diş Çapı : M12X1,25	1J0407366, 1J0407366A 1J0407366AS, 1J0407366B 1J0407366C, 1J0407366CS 1J0407366D*, 1J0407366D 1J0407366H, 8Z0407366A
	AU1015 ROTİL SOL	Ağırlık : 0,35 kg / 0.772 lb Konik Ölçüsü : Ø15 Bağlantı Delik Çapı : Ø8,5 Aşık Diş Çapı : M12X1,25	1J0407365A, 1J0407365B 1J0407365C, 1J0407365D
	AU1015K ROTİL ÖN SOL Ø15 RB2529	Ağırlık : 0,5 kg / 1.102 lb Konik Ölçüsü : Ø15 Bağlantı Delik Çapı : Ø8,5 Aşık Diş Çapı : M12X1,25	1J0407365, 1J0407365A* 1J0407365A, 1J0407365AS 1J0407365B*, 1J0407365B 1J0407365C*, 1J0407365C 1J0407365CS, 1J0407365D*
	AU2009 ROTBAŞI SAĞ UZUN RD0332	Ağırlık : 0,37 kg / 0.816 lb Uzunluk : 92 mm / 3.62 inch Gövde Diş Çapı : M14X1,5 Aşık Diş Çapı : M12X1,5 Aşık Konik Çapı : Ø13,3	1J0422812B, 3A0422812B 6R0423812A
	AU2010 ROTBAŞI SOL RD0331	Ağırlık : 0,375 kg / 0.827 lb Uzunluk : 92 mm / 3.62 inch Gövde Diş Çapı : M14X1,5 Aşık Diş Çapı : M12X1,5 Aşık Konik Çapı : Ø13,2	1J0422811B, 1JD422811 3A0422811B, 6R0423811A
	AU2318 ROTBAŞI SOL KISA RB2318	Ağırlık : 0,312 kg / 0.688 lb Uzunluk : 76 mm / 2.99 inch Gövde Diş Çapı : M14X1,5 Aşık Diş Çapı : M12X1,5 Aşık Konik Çapı : Ø13,4	1J0422811, 1J0422811A
	AU2319 ROTBAŞI SAĞ KISA RB2319	Ağırlık : 0,315 kg / 0.694 lb Uzunluk : 76 mm / 2.99 inch Gövde Diş Çapı : M14X1,5 Aşık Diş Çapı : M12X1,5 Aşık Konik Çapı : Ø13,4	1J0422812, 1J0422812A
	AU3001 ROTMİLİ SOL VE SAĞ 318 RD0908	Ağırlık : 0,622 kg / 1.371 lb Uzunluk : 318 mm / 12.52 inch Gövde Diş Çapı : M16X1,5 Aşık Diş Çapı : M14X1,5	1J0422803B, 1J0422804B 1J0422804E, 1J0422807 1J0422807B, 1J0422821B
	AU3003 ROTMİLİ SAĞ-SOL UZUN L 360 MM RB2811	Ağırlık : 0,629 kg / 1.387 lb Uzunluk : 341 mm / 13.43 inch Gövde Diş Çapı : M16X1,5 Aşık Diş Çapı : M14X1,5	1J0422803A, 1J0422804A 1J0422807A, 1J0422807C 1J0422821, 1J0422821A 1J0822807B

* Bu sayfada ve katalogdaki tüm araçların adları, markaları, modelleri, sembolleri, logoları, orjinal numaraları (oe) ve diğer üçüncü parti numaraları sadece referans amaçlı kullanılmaktadır.

VW8001 / Süspansiyon Kit Ön

JETTA

MK4, A4

1999 - 2004

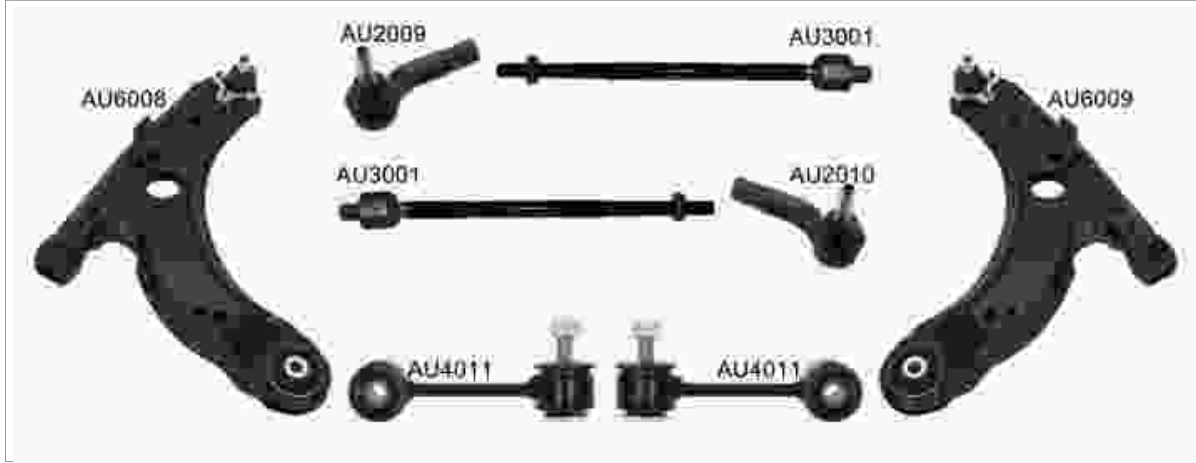

Kit Parçaları

Resim	Ürün Kodu / Adı	OEM	OEM	Ürün Kodu / Adı	Resim
	AU2009 Rotbaşı Sağ Uzun Rd0332	1J0422812B, 3A0422812B 6R0423812A	1J0422811B, 1JD422811 3A0422811B, 6R0423811A	AU2010 Rotbaşı Sol Rd0331	
	AU3001 Rotmili Sol Ve Sağ 318 Rd0908	1J0422803B, 1J0422804B 1J0422804E, 1J0422807 1J0422807B, 1J0422821B	1J0411315E, 1J0411315G 1J0422315G	VW4011 Z Rot Ön Sağ-sol Metal 105 Rd0916	
	AU6008 Salıncak Ön Sağ Rb3011	1J0407151B	1J0407151A	AU6009 Salıncak Ön Sol Rb3012	

VW8003 / Süspansiyon Kit Ön
JETTA
MK4, A4
1999 - 2004

Kit Parçaları



Resim	Ürün Kodu / Adı	OEM	OEM	Ürün Kodu / Adı	Resim
	AU1014 Rotil Alt Sağ Ø15	1J0407366A, 1J0407366AS 1J0407366B, 1J0407366C 1J0407366D, 1J0407366H	1J0407365A, 1J0407365B 1J0407365C, 1J0407365D	AU1015 Rotil Sol	
	AU11002 Salıncak Ve Denge Kolu Burcu Ön Sol Ve Sağ B22117	1J0407181, 1J0407181A	191407182, 357407182 357407182F	AU11005 Salıncak Ve Denge Kolu Burcu Ön Orta Sol Ve Sağ B40115	
	VW4011 Z Rot Ön Sağ-sol Metal 105 Rd0916	1J0411315E, 1J0411315G 1J0422315G			

JETTA
MK4, A4
1999 - 2004





Resim	Ürün Kodu ve Açıklaması	Detay	OEM
	AU20093001 ROT TAKIMI SAĞ	Ağırlık : 0,951 kg / 2.097 lb Rotbaşı : AU2009 Rotmili : AU3001	1H0422804B
	AU20103001 ROT TAKIMI SOL	Ağırlık : 0,952 kg / 2.099 lb Rotbaşı : AU2010 Rotmili : AU3001	1H0422803B
	AU23183003 ROT TAKIMI SAĞ RB288113	Ağırlık : 0,945 kg / 2.083 lb Rotbaşı : AU2318 Rotmili : AU3003	1J0422804, 1J0422804A 1J0422804C
	AU23193003 ROT TAKIMI SOL RB288112	Ağırlık : 0,94 kg / 2.072 lb Rotbaşı : AU2319 Rotmili : AU3003	1J0422803, 1J0422803A 1J0422803C
	AU4005 Z ROT ÖN SOL METAL RB2924	Ağırlık : 0,602 kg / 1.327 lb Malzeme Türü : Metal Uzunluk : 335 mm / 13.19 inch Aşık Diş Çapı : M12X1,5	1J0411315D, 1J0411615D
	AU4006 Z ROT ÖN SAĞ METAL RB2923	Ağırlık : 0,282 kg / 0.622 lb Malzeme Türü : Metal Uzunluk : 335 mm / 13.19 inch Aşık Diş Çapı : M12X1,5	1J0411316D
	AU4021 Z ROT SOL VE SAĞ METAL RB2940	Ağırlık : 0,26 kg / 0.573 lb Malzeme Türü : Metal Uzunluk : 175 mm / 6.89 inch Aşık Diş Çapı : M10X1,5	1J0505466, 1J0505466B 1J0505466C
	VW4010 Z ROT SOL VE SAĞ PLASTİK RD0924	Ağırlık : 0,18 kg / 0.397 lb Malzeme Türü : Plastik Uzunluk : 106 mm / 4.17 inch Aşık Diş Çapı : M10X1,5	1J0411315C, 1J0411315J
	VW4011 Z ROT ÖN SAĞ-SOL METAL 105 RD0916	Ağırlık : 0,258 kg / 0.569 lb Malzeme Türü : Metal Uzunluk : 106 mm / 4.17 inch Aşık Diş Çapı : M10X1,5	1J0411315E, 1J0411315G 1J0422315G
	VW4020 Z ROT ÖN SAĞ-SOL PLASTİK 105,5	Ağırlık : 0,151 kg / 0.333 lb Malzeme Türü : Plastik Uzunluk : 105 mm / 4.13 inch	1J0411315B, 1J0411315H 1J0411315K
	AU6008 SALINCAK ÖN SAĞ RB3011	Ağırlık : 3,495 kg / 7.705 lb Malzeme Türü : Sac Metal	1J0407151B

* Bu sayfada ve katalogdaki tüm araçların adları, markaları, modelleri, sembolleri, logoları, orijinal numaraları (oe) ve diğer üçüncü parti numaraları sadece referans amaçlı kullanılmaktadır.

JETTA
MK4, A4
1999 - 2004







Resim	Ürün Kodu ve Açıklaması	Detay	OEM
	AU6008J SALINCAK ÖN SAĞ RB3101	Ağırlık : 3,212 kg / 7.081 lb Malzeme Türü : Sac Metal	1J0407151C
	AU6009 SALINCAK ÖN SOL RB3012	Ağırlık : 3,495 kg / 7.705 lb Malzeme Türü : Sac Metal	1J0407151A
	AU11002 SALINCAK VE DENGE KOLU BURCU ÖN SOL VE SAĞ B22117	Şasi (Ön / Arka) : ÖN Yön : Sol Ve Sağ Ağırlık : 0,108 kg / 0.238 lb	1J0407181, 1J0407181A
	AU11005 SALINCAK VE DENGE KOLU BURCU ÖN ORTA SOL VE SAĞ B40115	Şasi (Ön / Arka) : ÖN Yön : Orta Sol Ve Sağ Ağırlık : 0,111 kg / 0.245 lb Not : VW6014 - VW60614J	191407182, 357407182 357407182F
	AU11023 Z-ROT BURCU ARKA	Şasi (Ön / Arka) : ARKA Ağırlık : 0.26 kg / 0.573 lb Uzunluk : AU4021 mm / 0.00 inch Aşık Dış Çapı : VW4017	1J0505466B*
	VW11090 Z-ROT BURCU ÖN	Şasi (Ön / Arka) : ÖN Ağırlık : 0,045 kg / 0.099 lb	1J0411315*, 1J0411315B* 1J0411315C*, 1J0411315E* 1J0411315G*, 1J0411315J*

JETTA
MK5, A5 III 1K2
2005 - 2010

Resim	Ürün Kodu ve Açıklaması	Detay	OEM
	VW1014 ROTİL ÖN ALT SAĞ Ø15,6 RB2536	Ağırlık : 0,565 kg / 1.246 lb Konik Ölçüsü : Ø15,6 Bağlantı Delik Çapı : Ø10,5 Aşık Dış Çapı : M12X1,5	1K0407366B, 1K0407366C 1K0407366E, 5Q0407366A
	VW1015 ROTİL ÖN ALT SOL Ø15,6 RB2537	Ağırlık : 0,565 kg / 1.246 lb Konik Ölçüsü : Ø15,6 Bağlantı Delik Çapı : Ø10,5 Aşık Dış Çapı : M12X1,5	1K0407365B, 1K0407365C 1K0407365E, 5Q0407365A
	VW2008 ROTBAŞI ÖN SAĞ RD0342	Ağırlık : 0,412 kg / 0.908 lb Uzunluk : 95 mm / 3.74 inch Gövde Dış Çapı : M16X1,5 Aşık Dış Çapı : M12X1,5 Aşık Konik Çapı : Ø12,7	1K0423812A, 1K0423812C 1K0423812E, 1K0423812G 1K0423812J, 1K0423812K 1KD423812A
	VW2009 ROTBAŞI ÖN SOL RD0343	Ağırlık : 0,412 kg / 0.908 lb Uzunluk : 95 mm / 3.74 inch Gövde Dış Çapı : M16X1,5 Aşık Dış Çapı : M12X1,5 Aşık Konik Çapı : Ø13,5	1K0423811A, 1K0423811C 1K0423811E, 1K0423811G 1K0423811J, 1K0423811K 1KD423811A











* Bu sayfada ve katalogdaki tüm araçların adları, markaları, modelleri, sembolleri, logoları, orijinal numaraları (oe) ve diğer üçüncü parti numaraları sadece referans amaçlı kullanılmaktadır.

JETTA
MK5, A5 III 1K2
2005 - 2010

Resim	Ürün Kodu ve Açıklaması	Detay	OEM
	VW3009 ROTMİLİ SAĞ-SOL 310 RB2838	Ağırlık : 0,665 kg / 1.466 lb Uzunluk : 311 mm / 12.24 inch Gövde Diş Çapı : M16X1,5 Aşık Diş Çapı : M16X1,5	1K0423810A
	VW20083009 ROT TAKIMI ÖN AKS SAĞ RB288137	Ağırlık : 1,078 kg / 2.377 lb Rotbaşı : VW2008 Rotmili : VW3009	
	VW20093009 ROT TAKIMI ÖN SOL RB288138	Ağırlık : 1,077 kg / 2.374 lb Rotbaşı : VW2009 Rotmili : VW3009	
	SK4005 Z ROT ÖM SAĞ-SOL L=335MM	Ağırlık : 0,322 kg / 0.710 lb Malzeme Türü : Metal Uzunluk : 335 mm / 13.19 inch Aşık Diş Çapı : M12X1,5	5Q0411315B
	VW4014 Z ROT ÖN SAĞ-SOL METAL 335 RB2935	Ağırlık : 0,46 kg / 1.014 lb Malzeme Türü : Metal Uzunluk : 335 mm / 13.19 inch Aşık Diş Çapı : M12X1,5	1K0411315B, 1K0411315D 1K0411315J, 1K0411315K 1K0411315R, 5Q0411315A 5Q0411315B
	VW4015 Z ROT SOL VE SAĞ METAL RB2937	Ağırlık : 0,373 kg / 0.822 lb Malzeme Türü : Metal Uzunluk : 95,5 mm / 3.76 inch Aşık Diş Çapı : M10X1,5	1K0505465C, 1K0505465D 1K0505465H, 1K0505465J 1K0505465K
	VW4015K Z ROT SOL VE SAĞ METAL	Ağırlık : 0,373 kg / 0.822 lb Malzeme Türü : Metal Uzunluk : 95,5 mm / 3.76 inch Aşık Diş Çapı : M10X1,5	1K0505465C, 1K0505465D 1K0505465H, 1K0505465J 1K0505465K
	AU6010 SALINCAK ÜST SOL VE SAĞ RA5155	Ağırlık : 1,298 kg / 2.862 lb Malzeme Türü : Sac Metal	1K0505323H, 1K0505323N
	VW6016 SALINCAK ÖN SAĞ RD10227	Ağırlık : 4,543 kg / 10.016 lb Malzeme Türü : Sac Metal	1K0407152P, 1K0407152Q* 1K0407152Q
	VW6016J SALINCAK ÖN ALT SAĞ S737	Ağırlık : 4,015 kg / 8.852 lb Malzeme Türü : Sac Metal	1K0407151P, 1K0407151Q 1K0407152P, 1K0407152Q
	VW6017 SALINCAK ÖN SOL RD10226	Ağırlık : 4,543 kg / 10.016 lb Malzeme Türü : Sac Metal	1K0407151M*, 1K0407151P 1K0407151Q*, 1K0407151Q

* Bu sayfada ve katalogdaki tüm araçların adları, markaları, modelleri, sembolleri, logoları, orjinal numaraları (oe) ve diğer üçüncü parti numaraları sadece referans amaçlı kullanılmaktadır.

JETTA
MK5, A5 III 1K2
2005 - 2010

Resim	Ürün Kodu ve Açıklaması	Detay	OEM
	VW6017J SALINCAK ÖN ALT SOL S738	Ağırlık : 4,015 kg / 8.852 lb Malzeme Türü : Sac Metal	1K0407151P, 1K0407151Q 1K0407152P, 1K0407152Q
	VW9001 SALINCAK ARKA	Ağırlık : 2,55 kg / 5.622 lb Malzeme Türü : Sac Metal	1K0505311AA, 1K0505311ABÂ 1K0505311H, 1K0505311S 1K0505311T
	AU11014 SALINCAK VE DENGE KOLU BURCU ARKA SOL VE SAĞ	Şasi (Ön / Arka) : ARKA Yön : Sol Ve Sağ Ağırlık : 0.192 kg / 0.423 lb	1K0505543A
	AU11035 SALINCAK VE DENGE KOLU BURCU ARKA SOL VE SAĞ	Şasi (Ön / Arka) : ARKA Yön : Sol Ve Sağ Ağırlık : 0,25 kg / 0.551 lb	1K0505171C
	VW11037 SALINCAK VE DENGE KOLU BURCU SOL VE SAĞ	Yön : Sol Ve Sağ Ağırlık : 0.11 kg / 0.243 lb	1K0505279A
	VW11042 SALINCAK VE DENGE KOLU BURCU ORTA SOL VE SAĞ	Yön : Orta Sol Ve Sağ Ağırlık : 0,182 kg / 0.401 lb	1K0407182, 5Q0407182
	VW11043 SALINCAK VE DENGE KOLU BURCU SAĞ B22141	Yön : Sağ Diğer Taraf : VW11044 Ağırlık : 0,659 kg / 1.453 lb	1K0199232G, 1K0199232H 1K0199232J
	VW11043B SALINCAK VE DENGE KOLU BURCU SAĞ	Yön : Sağ Diğer Taraf : VW11044B Ağırlık : 0,659 kg / 1.453 lb Not : İÇ BURÇSUZ	1K0199232G, 1K0199232H 1K0199232J
	VW11044 SALINCAK VE DENGE KOLU BURCU SOL B22142	Yön : Sol Diğer Taraf : VW11043 Ağırlık : 0,678 kg / 1.495 lb	1K0199231G, 1K0199231H 1K0199231J
	VW11044B SALINCAK VE DENGE KOLU BURCU SOL	Yön : Sol Diğer Taraf : VW11043B Ağırlık : 0,678 kg / 1.495 lb Not : İÇ BURÇSUZ	1K0199231G, 1K0199231H 1K0199231J
	VW11051 SALINCAK VE DENGE KOLU BURCU SOL VE SAĞ	Yön : Sol Ve Sağ Ağırlık : 0.121 kg / 0.267 lb	6Q0407183, 6Q0407183A











* Bu sayfada ve katalogdaki tüm araçların adları, markaları, modelleri, sembolleri, logoları, orjinal numaraları (oe) ve diğer üçüncü parti numaraları sadece referans amaçlı kullanılmaktadır.

JETTA
MK5, A5 III 1K2
2005 - 2010

Resim	Ürün Kodu ve Açıklaması	Detay	OEM
	VW11056 SALINCAK VE DENG KOLU BURCU ARKA SOL VE SAĞ	Şasi (Ön / Arka) : ARKA Yön : Sol Ve Sağ Ağırlık : 0.13 kg / 0.287 lb	1K0505203A, 1K0505323D 1K0505323G, 1K0505323H 1K0505323N, 5Q0505323C
	VW11180 Z-ROT BURCU ARKA	Şasi (Ön / Arka) : ARKA Ağırlık : 0.069 kg / 0.152 lb Uzunluk : VW4015 mm / 0.00 inch Aşık Diş Çapı : VW4015K	1K0505465C*, 1K0505465D* 1K0505465H*, 1K0505465J* 1K0505465K*
	VW12159 TAŞIYICI DESTEK BURÇLARI ARKA SOL VE SAĞ	Şasi (Ön / Arka) : ARKA Yön : Sol Ve Sağ Ağırlık : 0,130 kg / 0.287 lb	1K0505553, 1K0505553A
	VW12017 AMORTİSÖR TAKOZU SOL VE SAĞ AMORTİSÖR TAKOZU	Yön : Sol Ve Sağ Ağırlık : 0.847 kg / 1.867 lb Not : AMORTİSÖR TAKOZU	1K0412331B, 1K0412331C
	VW12109 AMORTİSÖR TAKOZU SOL VE SAĞ AMORTİSÖR RULMANI	Yön : Sol Ve Sağ Ağırlık : 0.26 kg / 0.573 lb Not : AMORTİSÖR RULMANI	6N0412249C, 6N0412249E
	VW12109K AMORTİSÖR TAKOZU SOL VE SAĞ 2 PCS	Yön : Sol Ve Sağ Ağırlık : 0.52 kg / 1.146 lb Not : 2 PCS	6N0412249C, 6N0412249E
	VW12025 MOTOR TAKOZU ALT SOL VE SAĞ MOTOR TAKOZU ALT	Yön : Alt Sol Ve Sağ Ağırlık : 0.25 kg / 0.551 lb Not : MOTOR TAKOZU ALT	1K0199867A, 1K0199867B 1K0199867Q
	VW12027 MOTOR TAKOZU SOL VE SAĞ MOTOR KULAĞI	Yön : Sol Ve Sağ Ağırlık : 2.02 kg / 4.453 lb Not : MOTOR KULAĞI	1K0199262, 1K0199262CN
	VW12029 MOTOR TAKOZU SOL VE SAĞ MOTOR TAKOZU	Yön : Sol Ve Sağ Ağırlık : 0.585 kg / 1.290 lb Not : Motor takoZu	1K0199855AD, 1K0199855BA 1K0199855K
	VW12032 MOTOR TAKOZU SOL VE SAĞ MOTOR TAKOZU	Yön : Sol Ve Sağ Ağırlık : 0.64 kg / 1.411 lb Not : Motor takoZu	1K0199855BB, 1K0199855L
	VW12033 MOTOR TAKOZU SOL VE SAĞ MOTOR TAKOZU	Yön : Sol Ve Sağ Ağırlık : 1.84 kg / 4.057 lb Not : Motor takoZu	1K0199555AQ, 1K0199555AR 1K0199555Q, 1K0199555R 3C0199555AA, 3C0199555R







* Bu sayfada ve katalogdaki tüm araçların adları, markaları, modelleri, sembolleri, logoları, orjinal numaraları (oe) ve diğer üçüncü parti numaraları sadece referans amaçlı kullanılmaktadır.

JETTA
MK5, A5 III 1K2
2005 - 2010



Resim	Ürün Kodu ve Açıklaması	Detay	OEM
	VW12034 MOTOR TAKOZU SOL VE SAĞ MOTOR TAKOZU	Yön : Sol Ve Sağ Ağırlık : 1.9 kg / 4.189 lb Not : Motor takozu	1K0199555BA, 1K0199555BB 1K0199555L, 1K0199555M 1L0199555L
	VW12073 MOTOR TAKOZU SOL VE SAĞ MOTOR TAKOZU	Yön : Sol Ve Sağ Ağırlık : 1.643 kg / 3.622 lb Not : MOTOR TAKOZU	1K0199262AC, 1K0199262AL 1K0199262L
	VW12076 MOTOR TAKOZU SOL VE SAĞ MOTOR TAKOZU	Yön : Sol Ve Sağ Ağırlık : 1.97 kg / 4.343 lb Not : MOTOR TAKOZU	1K0199262AF, 1K0199262AT 1K0199262BB
	VW12077 MOTOR TAKOZU SOL VE SAĞ MOTOR TAKOZU	Yön : Sol Ve Sağ Ağırlık : 1.95 kg / 4.299 lb Not : MOTOR TAKOZU	1K0199262CG, 1K0199262CP
	VW12078 MOTOR TAKOZU SOL VE SAĞ ŞANZUMAN TAKOZU	Yön : Sol Ve Sağ Ağırlık : 1.78 kg / 3.924 lb Not : ŞANZUMAN TAKOZU	1K0199555AC
	VW12082 MOTOR TAKOZU SOL VE SAĞ MOTOR TAKOZU	Yön : Sol Ve Sağ Ağırlık : 2.05 kg / 4.519 lb Not : MOTOR TAKOZU	1K0199262AK, 1K0199262K
	VW12094 MOTOR TAKOZU SOL VE SAĞ MOTOR TAKOZU	Yön : Sol Ve Sağ Ağırlık : 1.872 kg / 4.127 lb Not : MOTOR TAKOZU	1K0199555N
	VW12097 MOTOR TAKOZU SOL VE SAĞ MOTOR TAKOZU	Yön : Sol Ve Sağ Ağırlık : 0.251 kg / 0.553 lb Not : MOTOR TAKOZU	1K0199868, 1K0199868A 1K0199868C, 1K0199868P 1K0199868Q
	VW12110 MOTOR TAKOZU SOL VE SAĞ MOTOR TAKOZU	Yön : Sol Ve Sağ Ağırlık : 1.918 kg / 4.228 lb Not : MOTOR TAKOZU	1K0199262AB, 1K0199262AM 1K0199262M
	VW12124 MOTOR TAKOZU SOL VE SAĞ	Yön : Sol Ve Sağ Ağırlık : 1.927 kg / 4.248 lb	1K0199262A, 1K0199262AA 1K0199262AS
	VW12106 ŞANZIMAN TAKOZU SOL ŞANZUMAN TAKOZU SOL	Yön : Sol Ağırlık : 1.95 kg / 4.299 lb Not : ŞANZUMAN TAKOZU SOL	1K0199555AT, 1K0199555T

* Bu sayfada ve katalogdaki tüm araçların adları, markaları, modelleri, sembolleri, logoları, orjinal numaraları (oe) ve diğer üçüncü parti numaraları sadece referans amaçlı kullanılmaktadır.

JETTA
MK5, A5 III 1K2
2005 - 2010

Resim	Ürün Kodu ve Açıklaması	Detay	OEM
	VW12051 SÜSPANSİYON TAKOZU SOL VE SAĞ LASTİK DAYANAK SUSPENSİYON	Yön : Sol Ve Sağ Ağırlık : 0.045 kg / 0.099 lb Not : LASTİK DAYANAK SUSPENSİYON	1K0412303B
	VW12086 RADYATÖR TAKOZU SOL VE SAĞ RADYATÖR ÜST LASTİĞİ	Yön : Sol Ve Sağ Ağırlık : 0.024 kg / 0.053 lb Not : RADYATÖR ÜST LASTİĞİ	1K0121367F
	VW13006 DİREKSİYON KÖRÜĞÜ	Ağırlık : 0.145 kg / 0.320 lb	1K0423831A, 5C0423831
	VW13006K DİREKSİYON KÖRÜĞÜ SOL VE SAĞ 2 PİECES	Ağırlık : 0.29 kg / 0.639 lb	1K0423831A, 5C0423831
	VW14003 AKS KÖRÜĞÜ +KELEPÇE+YAĞ. DIŞ	Ağırlık : 0.25 kg / 0.551 lb	1K0 498 203, 1K0498203
	AU15001 AMORTİSÖR KÖRÜĞÜ ÖN	Şasi (Ön / Arka) : ÖN Ağırlık : 0,110 kg / 0.243 lb	6N0413175A
	VW15002 AMORTİSÖR KÖRÜĞÜ ARKA	Şasi (Ön / Arka) : ARKA	900064

JETTA
MK6, A6 IV 162
2010 - 2017

Resim	Ürün Kodu ve Açıklaması	Detay	OEM
	VW1014 ROTİL ÖN ALT SAĞ Ø15,6 RB2536	Ağırlık : 0,565 kg / 1.246 lb Konik Ölçüsü : Ø15,6 Bağlantı Delik Çapı : Ø10,5 Aşık Diş Çapı : M12X1,5	1K0407366B, 1K0407366C 1K0407366E, 5Q0407366A
	VW1015 ROTİL ÖN ALT SOL Ø15,6 RB2537	Ağırlık : 0,565 kg / 1.246 lb Konik Ölçüsü : Ø15,6 Bağlantı Delik Çapı : Ø10,5 Aşık Diş Çapı : M12X1,5	1K0407365B, 1K0407365C 1K0407365E, 5Q0407365A
	VW2008 ROTBAŞI ÖN SAĞ RD0342	Ağırlık : 0,412 kg / 0.908 lb Uzunluk : 95 mm / 3.74 inch Gövde Diş Çapı : M16X1,5 Aşık Diş Çapı : M12X1,5 Aşık Konik Çapı : Ø12,7	1K0423812A, 1K0423812C 1K0423812E, 1K0423812G 1K0423812J, 1K0423812K 1KD423812A











* Bu sayfada ve katalogdaki tüm araçların adları, markaları, modelleri, sembolleri, logoları, orjinal numaraları (oe) ve diğer üçüncü parti numaraları sadece referans amaçlı kullanılmaktadır.

JETTA
MK6, A6 IV 162
2010 - 2017

Resim	Ürün Kodu ve Açıklaması	Detay	OEM
	VW2009 ROTBAŞI ÖN SOL RD0343	Ağırlık : 0,412 kg / 0.908 lb Uzunluk : 95 mm / 3.74 inch Gövde Diş Çapı : M16X1,5 Aşık Diş Çapı : M12X1,5 Aşık Konik Çapı : Ø13,5	1K0423811A, 1K0423811C 1K0423811E, 1K0423811G 1K0423811J, 1K0423811K 1KD423811A
	VW3009 ROTMİLİ SAĞ-SOL 310 RB2838	Ağırlık : 0,665 kg / 1.466 lb Uzunluk : 311 mm / 12.24 inch Gövde Diş Çapı : M16X1,5 Aşık Diş Çapı : M16X1,5	1K0423810A
	VW20083009 ROT TAKIMI ÖN AKS SAĞ RB288137	Ağırlık : 1,078 kg / 2.377 lb Rotbaşı : VW2008 Rotmilî : VW3009	
	VW20093009 ROT TAKIMI ÖN SOL RB288138	Ağırlık : 1,077 kg / 2.374 lb Rotbaşı : VW2009 Rotmilî : VW3009	
	SK4005 Z ROT ÖM SAĞ-SOL L=335MM	Ağırlık : 0,322 kg / 0.710 lb Malzeme Türü : Metal Uzunluk : 335 mm / 13.19 inch Aşık Diş Çapı : M12X1,5	5Q0411315B
	VW4014 Z ROT ÖN SAĞ-SOL METAL 335 RB2935	Ağırlık : 0,46 kg / 1.014 lb Malzeme Türü : Metal Uzunluk : 335 mm / 13.19 inch Aşık Diş Çapı : M12X1,5	1K0411315B, 1K0411315D 1K0411315J, 1K0411315K 1K0411315R, 5Q0411315A 5Q0411315B
	AU6010 SALINCAK ÜST SOL VE SAĞ RA5155	Ağırlık : 1,298 kg / 2.862 lb Malzeme Türü : Sac Metal	1K0505323H, 1K0505323N
	SK9001 SALINCAK ARKA ALT	Ağırlık : 0,701 kg / 1.545 lb Malzeme Türü : Sac Metal	1K0501529J
	VW6041 SALINCAK ÖN SAĞ	Ağırlık : 3,88 kg / 8.554 lb Malzeme Türü : Sac Metal	1K0407152B*, 5C0407152B
	VW6041J SALINCAK ÖN SAĞ	Ağırlık : 3,33 kg / 7.341 lb Malzeme Türü : Sac Metal	5C0407152B*
	VW6042 SALINCAK ÖN SOL	Ağırlık : 3,88 kg / 8.554 lb Malzeme Türü : Sac Metal	1K0407151B*, 1K0407151B











* Bu sayfada ve katalogdaki tüm araçların adları, markaları, modelleri, sembolleri, logoları, orjinal numaraları (oe) ve diğer üçüncü parti numaraları sadece referans amaçlı kullanılmaktadır.

JETTA
MK6, A6 IV 162
2010 - 2017

Resim	Ürün Kodu ve Açıklaması	Detay	OEM
	VW6042J SALINCAK ÖN SOL	Ağırlık : 3,33 kg / 7.341 lb Malzeme Türü : Sac Metal	1K0407151B, 5C0407151B* 5C0407151B
	VW9001 SALINCAK ARKA	Ağırlık : 2,55 kg / 5.622 lb Malzeme Türü : Sac Metal	1K0505311AA, 1K0505311ABÂ 1K0505311H, 1K0505311S 1K0505311T
	AU11014 SALINCAK VE DENGİ KOLU BURCU ARKA SOL VE SAĞ	Şasi (Ön / Arka) : ARKA Yön : Sol Ve Sağ Ağırlık : 0.192 kg / 0.423 lb	1K0505543A
	AU11035 SALINCAK VE DENGİ KOLU BURCU ARKA SOL VE SAĞ	Şasi (Ön / Arka) : ARKA Yön : Sol Ve Sağ Ağırlık : 0,25 kg / 0.551 lb	1K0505171C
	AU11052 SALINCAK VE DENGİ KOLU BURCU SOL VE SAĞ	Yön : Sol Ve Sağ Ağırlık : 0,178 kg / 0.392 lb	1K0505541B, 1K0505541C 1K0505541D
	SK11009 SALINCAK VE DENGİ KOLU BURCU ARKA SOL VE SAĞ	Şasi (Ön / Arka) : ARKA Yön : Sol Ve Sağ Ağırlık : 0,176 kg / 0.388 lb	1K0501529J*
	SK11010 SALINCAK VE DENGİ KOLU BURCU ARKA SOL VE SAĞ	Şasi (Ön / Arka) : ARKA Yön : Sol Ve Sağ Ağırlık : 0,196 kg / 0.432 lb Not : BÜYÜK	1K0501529J*
	VW11037 SALINCAK VE DENGİ KOLU BURCU SOL VE SAĞ	Yön : Sol Ve Sağ Ağırlık : 0.11 kg / 0.243 lb	1K0505279A
	VW11042 SALINCAK VE DENGİ KOLU BURCU ORTA SOL VE SAĞ	Yön : Orta Sol Ve Sağ Ağırlık : 0,182 kg / 0.401 lb	1K0407182, 5Q0407182
	VW11056 SALINCAK VE DENGİ KOLU BURCU ARKA SOL VE SAĞ	Şasi (Ön / Arka) : ARKA Yön : Sol Ve Sağ Ağırlık : 0.13 kg / 0.287 lb	1K0505203A, 1K0505323D 1K0505323G, 1K0505323H 1K0505323N, 5Q0505323C
	VW11065 SALINCAK VE DENGİ KOLU BURCU ÖN SOL VE SAĞ	Şasi (Ön / Arka) : ÖN Yön : Sol Ve Sağ Ağırlık : 0.22 kg / 0.485 lb	1K0407183M*, 1K0407183M 1K0407183P*, 1K0407183P 5C0407183A*, 5C0407183A





* Bu sayfada ve katalogdaki tüm araçların adları, markaları, modelleri, sembolleri, logoları, orijinal numaraları (oe) ve diğer üçüncü parti numaraları sadece referans amaçlı kullanılmaktadır.

JETTA
MK6, A6 IV 162
2010 - 2017

Resim	Ürün Kodu ve Açıklaması	Detay	OEM
	VW12159 TAŞIYICI DESTEK BURÇLARI ARKA SOL VE SAĞ	Şasi (Ön / Arka) : ARKA Yön : Sol Ve Sağ Ağırlık : 0,130 kg / 0.287 lb	1K0505553, 1K0505553A
	VW12137 VİRAJ DEMİR LASTİĞİ	Şasi (Ön / Arka) : ARKA Ağırlık : 0,070 kg / 0.154 lb Not : Ø17mm	1K0511327AQ
	VW12137K VİRAJ DEMİR LASTİĞİ	Şasi (Ön / Arka) : ARKA Ağırlık : 0,140 kg / 0.309 lb Not : KIT	1K0511327AQ
	VW12017 AMORTİSÖR TAKOZU SOL VE SAĞ AMORTİSÖR TAKOZU	Yön : Sol Ve Sağ Ağırlık : 0.847 kg / 1.867 lb Not : AMORTİSÖR TAKOZU	1K0412331B, 1K0412331C
	VW12109 AMORTİSÖR TAKOZU SOL VE SAĞ AMORTİSÖR RULMANI	Yön : Sol Ve Sağ Ağırlık : 0.26 kg / 0.573 lb Not : AMORTİSÖR RULMANI	6N0412249C, 6N0412249E
	VW12109K AMORTİSÖR TAKOZU SOL VE SAĞ 2 PCS	Yön : Sol Ve Sağ Ağırlık : 0.52 kg / 1.146 lb Not : 2 PCS	6N0412249C, 6N0412249E
	VW12027 MOTOR TAKOZU SOL VE SAĞ MOTOR KULAĞI	Yön : Sol Ve Sağ Ağırlık : 2.02 kg / 4.453 lb Not : MOTOR KULAĞI	1K0199262, 1K0199262CN
	VW12038 SÜSPANSİYON TAKOZU SOL VE SAĞ SUS. ARA YATAK TAKOZ ARKA	Yön : Sol Ve Sağ Ağırlık : 0.12 kg / 0.265 lb Not : SUS. ARA YATAK TAKOZ ARKA	3C0 511 359, 3C0511359
	VW12051 SÜSPANSİYON TAKOZU SOL VE SAĞ LASTİK DAYANAK SÜSPANSİYON	Yön : Sol Ve Sağ Ağırlık : 0.045 kg / 0.099 lb Not : LASTİK DAYANAK SÜSPANSİYON	1K0412303B
	VW12086 RADYATÖR TAKOZU SOL VE SAĞ RADYATÖR ÜST LASTİĞİ	Yön : Sol Ve Sağ Ağırlık : 0.024 kg / 0.053 lb Not : RADYATÖR ÜST LASTİĞİ	1K0121367F
	VW13006 DİREKSİYON KÖRÜĞÜ	Ağırlık : 0.145 kg / 0.320 lb	1K0423831A, 5C0423831

* Bu sayfada ve katalogdaki tüm araçların adları, markaları, modelleri, sembolleri, logoları, orjinal numaraları (oe) ve diğer üçüncü parti numaraları sadece referans amaçlı kullanılmaktadır.

JETTA
MK6, A6 IV 162
2010 - 2017

Resim	Ürün Kodu ve Açıklaması	Detay	OEM
	VW13006K DİREKSİYON KÖRÜĞÜ SOL VE SAĞ 2 PİECES	Ağırlık : 0.29 kg / 0.639 lb	1K0423831A, 5C0423831
	VW14003 AKS KÖRÜĞÜ +KELEPÇE+YAĞ. DIŞ	Ağırlık : 0.25 kg / 0.551 lb	1K0 498 203, 1K0498203
	AU15001 AMORTİSÖR KÖRÜĞÜ ÖN	Şasi (Ön / Arka) : ÖN Ağırlık : 0,110 kg / 0.243 lb	6N0413175A
	VW15002 AMORTİSÖR KÖRÜĞÜ ARKA	Şasi (Ön / Arka) : ARKA	900064

LT
I
1975 - 1996



Resim	Ürün Kodu ve Açıklaması	Detay	OEM
	VW1026 ROTİL ÜST RD0520	Ağırlık : 0,75 kg / 1.653 lb Konik Ölçüsü : Ø19,8 Bağlantı Delik Çapı : M10X1,5 Aşık Diş Çapı : M18X1,5	281407361
	VW1027 ROTİL ALT RD0518	Ağırlık : 1,635 kg / 3.605 lb Konik Ölçüsü : Ø23,7 Bağlantı Delik Çapı : Ø10,5 Aşık Diş Çapı : M20X1,5	281407187, 281407187B
	VW2020 ROTBAŞI M16X1,5 RHT RD0215	Ağırlık : 0,38 kg / 0.838 lb Uzunluk : 79,5 mm / 3.13 inch Gövde Diş Çapı : M16X1,5 Aşık Diş Çapı : M12X1,5 Aşık Konik Çapı : Ø14,5	281415801D, 281415801DRH
	VW2021 ROTBAŞI M16X1,5 LHT RD0216	Ağırlık : 0,376 kg / 0.829 lb Uzunluk : 79,5 mm / 3.13 inch Gövde Diş Çapı : M16X1,5 Aşık Diş Çapı : M12X1,5 Aşık Konik Çapı : Ø14,5	281415801D, 281415801DLH
	VW7001 ARA ROT ÖN AKS	Şasi (Ön / Arka) : ÖN Yön : Sol Ve Sağ Ağırlık : 3.39 kg / 7.474 lb Uzunluk : 806 mm / 31.73 inch	281415303B
	VW7002 ARA ROT ÖN AKS RD0711	Şasi (Ön / Arka) : ÖN Yön : Sol Ve Sağ Ağırlık : 0,94 kg / 2.072 lb Uzunluk : 362 mm / 14.25 inch	281415802, 281415802A

* Bu sayfada ve katalogdaki tüm araçların adları, markaları, modelleri, sembolleri, logoları, orjinal numaraları (oe) ve diğer üçüncü parti numaraları sadece referans amaçlı kullanılmaktadır.

LT I 1975 - 1996

Resim	Ürün Kodu ve Açıklaması	Detay	OEM
	VW7003 ARA ROT ÖN AKS	Şasi (Ön / Arka) : ÖN Yön : Sol Ve Sağ Ağırlık : 1,288 kg / 2.840 lb	281415801D
	VW11030 SALINCAK VE DENGE KOLU BURCU ÖN ÜST SOL VE SAĞ	Şasi (Ön / Arka) : ÖN Yön : Üst Sol Ve Sağ Ağırlık : 0,379 kg / 0.836 lb	281407077

LT II 1996 - 2006

Resim	Ürün Kodu ve Açıklaması	Detay	OEM
	ME1012 ROTİL ALT SAĞ-SOL RC0416	Ağırlık : 0,69 kg / 1.521 lb Konik Ölçüsü : Ø23,5 Aşık Diş Çapı : M20X1,5 Rotil Gövde Çapı : Ø45,2	2D0407361A, 2D0407361B 9013330627, 9013330727 9013331127, 9013331227 9014600348
	ME2023 ROTBAŞI SAĞ-SOL RC0327	Ağırlık : 0,43 kg / 0.948 lb Uzunluk : 77 mm / 3.03 inch Gövde Diş Çapı : M16X1,5 Aşık Diş Çapı : M16X1,5 Aşık Konik Çapı : Ø18,1	2D0422811, 9014600048 9014600148
	ME3008 ROTMİLİ ÖN SAĞ - SOL 384 RC0813	Ağırlık : 0,818 kg / 1.803 lb Uzunluk : 384 mm / 15.12 inch Gövde Diş Çapı : M16X1,5 Aşık Diş Çapı : M16X1,5	2D0422803, 9014600155 9014600255, 9014600455

ME8005 / Süspansiyon Kit Ön
LT
II
1996 - 2006



Kit Parçaları

Resim	Ürün Kodu / Adı	OEM	OEM	Ürün Kodu / Adı	Resim
	ME2023 Rotbaşı Sağ-sol Rc0327	2D0422811, 9014600048 9014600148	2D0422803, 9014600155 9014600255, 9014600455	ME3008 Rotmili Ön Sağ - Sol 384 Rc0813	
	ME4022 Z Rot Ön Sağ Metal 115 Rc0947	2D0411052, 9013200389	2D0411051, 9013200289	ME4023 Z Rot Sol 115 Rc0948	
	ME6025 Salıncak Ön Alt Sağ Rc1039	2D0407022, 2D0407022B 9013301707, 9013301907 9013302507	2D0407021, 9013301807	ME6026 Salıncak Ön Alt Sol Rc1038	

LT	II		1996 - 2006
Resim	Ürün Kodu ve Açıklaması	Detay	OEM
	ME20233008 ROT TAKIMI ÖN AKS RC088113	Ağırlık : 1,25 kg / 2.756 lb Rotbaşı : ME2023 Rotmilili : ME3008	2D0422803, 9014600205 A9014600205
	ME4022 Z ROT ÖN SAĞ METAL 115 RC0947	Ağırlık : 0,171 kg / 0.377 lb Malzeme Türü : Metal Uzunluk : 115 mm / 4.53 inch	2D0411052, 9013200389
	ME4023 Z ROT SOL 115 RC0948	Ağırlık : 0,171 kg / 0.377 lb Uzunluk : 115 mm / 4.53 inch	2D0411051, 9013200289
	ME4024 Z ROT SOL VE SAĞ METAL RC0987	Ağırlık : 0,23 kg / 0.507 lb Malzeme Türü : Metal Uzunluk : 93 mm / 3.66 inch	2D0511329, 9013200089
	ME6025 SALINCAK ÖN ALT SAĞ RC1039	Ağırlık : 7,5 kg / 16.535 lb Malzeme Türü : Sac Metal	2D0407022, 2D0407022B 9013301707, 9013301907 9013302507
	ME6026 SALINCAK ÖN ALT SOL RC1038	Ağırlık : 7,5 kg / 16.535 lb Malzeme Türü : Sac Metal	2D0407021, 9013301807
	VW11029 SALINCAK VE DENGE KOLU BURCU ORTA SOL VE SAĞ B30135	Yön : Orta Sol Ve Sağ Ağırlık : 0,261 kg / 0.575 lb	2D0407140, 9013330214 A9013330214
	VW11030 SALINCAK VE DENGE KOLU BURCU ÖN ÜST SOL VE SAĞ	Şasi (Ön / Arka) : ÖN Yön : Üst Sol Ve Sağ Ağırlık : 0,379 kg / 0.836 lb	281407077
	ME11125 Z-ROT BURCU ARKA	Şasi (Ön / Arka) : ARKA Ağırlık : 0.1 kg / 0.220 lb Uzunluk : ME4024 mm / 0.00 inch	05103955AA, 2D0511413 6013210250, 6013210350 6013210450, 9013230285
	ME12035 Z-ROT BURCU ÖN SOL VE SAĞ KAUÇUK	Şasi (Ön / Arka) : ÖN Yön : Sol Ve Sağ Ağırlık : 0.12 kg / 0.265 lb Malzeme Türü : Kauçuk	2013521046, 2023520446 2D0411041A, 6013210350 9013230285, A2013521046 A2023520446, A9013230285
	ME12035K Z-ROT BURCU ÖN KAUÇUK	Şasi (Ön / Arka) : ÖN Ağırlık : 0.24 kg / 0.529 lb Malzeme Türü : Kauçuk	2D0411041A*, 2D0411041A 6013210350, 9013230285* 9013230285, A9013230285* A9013230285





* Bu sayfada ve katalogdaki tüm araçların adları, markaları, modelleri, sembolleri, logoları, orjinal numaraları (oe) ve diğer üçüncü parti numaraları sadece referans amaçlı kullanılmaktadır.

LT
II
1996 - 2006







Resim	Ürün Kodu ve Açıklaması	Detay	OEM
	ME11014 YAY BURCU ORTA SOL VE SAĞ	Yön : Orta Sol Ve Sağ Ağırlık : 0,204 kg / 0.450 lb	2D0511171, 9013240150
	ME12005 VİRAJ DEMİR LASTİĞİ SOL VE SAĞ RUBBER	Şasi (Ön / Arka) : ÖN Yön : Sol Ve Sağ Ağırlık : 0.102 kg / 0.225 lb Malzeme Türü : Rubber Not : VİRAJ LASTİĞİ	2D0511413B, 5118800AA 9043260881, A9043260881
	ME12005K VİRAJ DEMİR LASTİĞİ SOL VE SAĞ RUBBER	Şasi (Ön / Arka) : ÖN Yön : Sol Ve Sağ Ağırlık : 0.204 kg / 0.450 lb Malzeme Türü : Rubber	2D0511413B*, 5118800AA* 9043260881*, A9043260881*
	ME12007 VİRAJ DEMİR LASTİĞİ SOL VE SAĞ RUBBER	Şasi (Ön / Arka) : ÖN Yön : Sol Ve Sağ Ağırlık : 0.23 kg / 0.507 lb Malzeme Türü : Rubber Not : VİRAJ LASTİĞİ ÖN	2D0411041B, 9043230085
	ME12007K VİRAJ DEMİR LASTİĞİ SOL VE SAĞ RUBBER	Şasi (Ön / Arka) : ÖN Yön : Sol Ve Sağ Ağırlık : 0.46 kg / 1.014 lb Malzeme Türü : Rubber Not : VİRAJ LASTİĞİ ÖN İKİLİ	2D0411041B, 9043230085
	ME12008 VİRAJ DEMİR LASTİĞİ SOL VE SAĞ RUBBER	Şasi (Ön / Arka) : ÖN Yön : Sol Ve Sağ Ağırlık : 0.04 kg / 0.088 lb Malzeme Türü : Rubber Not : VİRAJ LASTİĞİ ARKA	2D0511413A, 5104073AA 9013260081
	ME12008K VİRAJ DEMİR LASTİĞİ SOL VE SAĞ RUBBER	Şasi (Ön / Arka) : ÖN Yön : Sol Ve Sağ Ağırlık : 0.08 kg / 0.176 lb Malzeme Türü : Rubber	2D0511413A*, 5104073AA* 9013260081*
	ME12060 VİRAJ DEMİR LASTİĞİ RUBBER	Şasi (Ön / Arka) : ARKA Ağırlık : 0.1 kg / 0.220 lb Malzeme Türü : Rubber	2D0511413, 6013210350
	ME12060K VİRAJ DEMİR LASTİĞİ RUBBER	Şasi (Ön / Arka) : ARKA Ağırlık : 0.2 kg / 0.441 lb Malzeme Türü : Rubber Not : 2 Pieces	2D0511413, 6013210350
	ME12022 MOTOR TAKOZU SOL VE SAĞ MOTOR TAKOZU	Yön : Sol Ve Sağ Ağırlık : 0.87 kg / 1.918 lb Not : MOTOR TAKOZU	9012412413
	ME12081 MOTOR TAKOZU ÖN SOL VE SAĞ	Şasi (Ön / Arka) : ÖN Yön : Sol Ve Sağ Ağırlık : 0,870 kg / 1.918 lb	2D0199379A, 2D0199379D 9012412513, 9012412713

* Bu sayfada ve katalogdaki tüm araçların adları, markaları, modelleri, sembolleri, logoları, orjinal numaraları (oe) ve diğer üçüncü parti numaraları sadece referans amaçlı kullanılmaktadır.

LT II 1996 - 2006



Resim	Ürün Kodu ve Açıklaması	Detay	OEM
	ME11015 ŞANZIMAN TAKOZU SOL VE SAĞ	Yön : Sol Ve Sağ Ağırlık : 0.628 kg / 1.385 lb	2D0199379B, 2D0399201 5104038AA, 9012421413 9012421513
	ME12033 ŞAFT TAKOZU SOL VE SAĞ ŞAFT ASKISI	Yön : Sol Ve Sağ Ağırlık : 1.012 kg / 2.231 lb Not : ŞAFT ASKISI	1683230744, 2D0598351 9014110312, 9014110412
	PE13000 DİREKSİYON KÖRÜĞÜ	Ağırlık : 0.098 kg / 0.216 lb	4066.57, 4066.73 406657
	ME15002 AMORTİSÖR KÖRÜĞÜ ÖN	Şasi (Ön / Arka) : ÖN Ağırlık : 0,085 kg / 0.187 lb	2D0412135, 9013230198 A9013230198

LUPO 5Z1 2004 - 2009

Resim	Ürün Kodu ve Açıklaması	Detay	OEM
	SK1023 ROTİL SAĞ RD0530	Ağırlık : 0,46 kg / 1.014 lb Konik Ölçüsü : Ø15 Bağlantı Delik Çapı : Ø8,5 Aşık Dış Çapı : M12X1,5	6Q0407366A, 6Q0407366B 6Q0407366E, 6Q0407366M 8Z0407366A
	SK1023K ROTİL ÖN ALT SAĞ Ø15 KIT	Ağırlık : 0,5 kg / 1.102 lb Konik Ölçüsü : Ø15 Bağlantı Delik Çapı : Ø8,5 Aşık Dış Çapı : M12X1,5	6Q0407366A*, 6Q0407366A 6Q0407366B*, 6Q0407366E* 6Q0407366M*, 6Q0407366M 8Z0407366A*
	SK1024 ROTİL SOL RD0531	Ağırlık : 0,46 kg / 1.014 lb Konik Ölçüsü : Ø15 Bağlantı Delik Çapı : Ø8,5 Aşık Dış Çapı : M12X1,5	6Q0407365A, 6Q0407365B 6Q0407365E, 6Q0407365M 8Z0407365A
	SK1024K ROTİL SOL	Ağırlık : 0,5 kg / 1.102 lb Konik Ölçüsü : Ø15 Bağlantı Delik Çapı : Ø8,5 Aşık Dış Çapı : M12X1,5	6Q0407365A*, 6Q0407365A 6Q0407365B*, 6Q0407365E* 6Q0407365E, 6Q0407365M* 6Q0407365M, 8Z0407365A*
	SK2003 ROTBAŞI SAĞ RC7314	Ağırlık : 0,377 kg / 0.831 lb Uzunluk : 93,5 mm / 3.68 inch Gövde Dış Çapı : M14X1,5 Aşık Dış Çapı : M12X1,5 Aşık Konik Çapı : Ø13,5	5Z0423812, 6Q0419812C 6Q0423812, 6Q0423812A 6Q0423812C, 6Q0423812D 6R0423812, 8Z0423811A
	SK2004 ROTBAŞI SOL RC7313	Ağırlık : 0,382 kg / 0.842 lb Uzunluk : 93 mm / 3.66 inch Gövde Dış Çapı : M14X1,5 Aşık Dış Çapı : M12X1,5 Aşık Konik Çapı : Ø13,5	5Z0423811, 6Q0419811C 6Q0423811, 6Q0423811A 6Q0423811C, 6Q0423811D 6R0423811, 8Z0423812A

* Bu sayfada ve katalogdaki tüm araçların adları, markaları, modelleri, sembolleri, logoları, orjinal numaraları (oe) ve diğer üçüncü parti numaraları sadece referans amaçlı kullanılmaktadır.

LUPO
SZ1
2004 - 2009









Resim	Ürün Kodu ve Açıklaması	Detay	OEM
	SK3003 ROTMİLİ SAĞ-SOL 297	Ağırlık : 0,552 kg / 1.217 lb Uzunluk : 297 mm / 11.69 inch Gövde Diş Çapı : M14X1,5 Aşık Diş Çapı : M14X1,5	6Q0 423 821 B, 6Q0423821B 6X0422803, 6X0422804 6X0422807, 6X0422821
	SK3004 ROTMİLİ SAĞ-SOL 300 RC7817	Ağırlık : 0,536 kg / 1.182 lb Uzunluk : 300 mm / 11.81 inch Gövde Diş Çapı : M16X1,5 Aşık Diş Çapı : M14X1,5	6Q0423803A, 6Q0423804A 6Q0-423-810-C, 6Q0423821A 6Q0423821C, 6Q0423821G
	VW3018 ROTMİLİ ÖN SAĞ-SOL	Ağırlık : 0,552 kg / 1.217 lb Uzunluk : 297 mm / 11.69 inch Gövde Diş Çapı : M14X1,5 Aşık Diş Çapı : M14X1,5	6X0422803, 6X0422804 6X0422807, 6X0422821
	SK20033003 ROT TAKIMI ÖN AKS SAĞ RC788115	Ağırlık : 1,021 kg / 2.251 lb Rotbaşı : SK2003 Rotmili : SK3003	6Q0422804B, 6Q0423804B
	SK20043003 ROT TAKIMI SOL RC788114	Ağırlık : 0,932 kg / 2.055 lb Rotbaşı : SK2004 Rotmili : SK3003	6Q0422803B, 6Q0423803B
	AU4028 Z ROT ÖN	Ağırlık : 0,368 kg / 0.811 lb Malzeme Türü : Metal Uzunluk : 270 mm / 10.63 inch Aşık Diş Çapı : M10X1,5	6Q0411315L, 6Q0411315N 8Z0411315D
	SK6009J SALINCAK ÖN ALT RD10211	Ağırlık : 2,626 kg / 5.789 lb Malzeme Türü : Sac Metal	6Q0407151D, 6Q0407151E 6Q0407151L
	VW11045 SALINCAK VE DENGİ KOLU BURCU ORTA SOL VE SAĞ B40128	Yön : Orta Sol Ve Sağ Ağırlık : 0,145 kg / 0.320 lb	6Q0407182A
	VW11047 SALINCAK VE DENGİ KOLU BURCU İÇ SOL VE SAĞ B37117	Yön : İç Sol Ve Sağ Ağırlık : 0,121 kg / 0.267 lb	1K0199231J, 1K0199231J-P 1K0407183E
	VW11055 SALINCAK VE DENGİ KOLU BURCU İÇ SOL VE SAĞ	Yön : İç Sol Ve Sağ Ağırlık : 0.121 kg / 0.267 lb	1K0407183E, 8J0407183
	VW12024 VİRAJ DEMİR LASTİĞİ SOL VE SAĞ RUBBER	Şasi (Ön / Arka) : ÖN Yön : Sol Ve Sağ Ağırlık : 0.03 kg / 0.066 lb Malzeme Türü : Rubber Not : VİRAJ LASTİĞİ	6Q0411303AA, 6Q0411303AD 6Q0411305H, 6Q0411314M 6Q0411314Q

* Bu sayfada ve katalogdaki tüm araçların adları, markaları, modelleri, sembolleri, logoları, orijinal numaraları (oe) ve diğer üçüncü parti numaraları sadece referans amaçlı kullanılmaktadır.

LUPO
5Z1
2004 - 2009











Resim	Ürün Kodu ve Açıklaması	Detay	OEM
	VW12024K VİRAJ DEMİR LASTİĞİ SOL VE SAĞ RUBBER	Şasi (Ön / Arka) : ÖN Yön : Sol Ve Sağ Ağırlık : 0.06 kg / 0.132 lb Malzeme Türü : Rubber Not : VİRAJ LASTİĞİ (İKİLİ)	6Q0411303AA*, 6Q0411303AA 6Q0411303AD*, 6Q0411303AD 6Q0411305H*, 6Q0411305H 6Q0411314M*, 6Q0411314M 6Q0411314Q*, 6Q0411314Q
	VW12036 SÜSPANSİYON TAKOZU SOL VE SAĞ ARKA SUSPANSİYON TAKOZU	Yön : Sol Ve Sağ Ağırlık : 1.591 kg / 3.508 lb Not : ARKA SUSPANSİYON TAKOZU	6Q0512131B

LUPO
6X1, 6E1
1998 - 2005

Resim	Ürün Kodu ve Açıklaması	Detay	OEM
	VW1028 ROTİL ÖN SAĞ Ø14,7	Ağırlık : 0,39 kg / 0.860 lb Konik Ölçüsü : Ø14,7 Bağlantı Delik Çapı : Ø8,5 Aşık Diş Çapı : M10X1	6N0407366
	VW1028K ROTİL ALT SAĞ RD0523	Ağırlık : 0,455 kg / 1.003 lb Konik Ölçüsü : Ø14,7 Bağlantı Delik Çapı : Ø8,5 Aşık Diş Çapı : M10X1	6E0307366, 6N0407366* 6N0407366A
	VW1029 ROTİL ÖN SOL Ø14,7	Ağırlık : 0,39 kg / 0.860 lb Konik Ölçüsü : Ø14,7 Bağlantı Delik Çapı : Ø8,5 Aşık Diş Çapı : M10X1	6N0407365, 6N0407365A
	VW1029K ROTİL ALT SOL RD0524	Ağırlık : 0,455 kg / 1.003 lb Konik Ölçüsü : Ø14,7 Bağlantı Delik Çapı : Ø8,5 Aşık Diş Çapı : M10X1	6N0407365*, 6N0407365 6N0407365A
	VW2006 ROTBAŞI SAĞ RD0312	Ağırlık : 0,3 kg / 0.661 lb Uzunluk : 76 mm / 2.99 inch Gövde Diş Çapı : M14X1,5 Aşık Diş Çapı : M12X1,5 Aşık Konik Çapı : Ø12,7	191419812, 22190091617 6N0419812, 6N0422812 XA2087
	VW2007 ROTBAŞI SOL RD0311	Ağırlık : 0,3 kg / 0.661 lb Uzunluk : 76 mm / 2.99 inch Gövde Diş Çapı : M14X1,5 Aşık Diş Çapı : M12X1,5 Aşık Konik Çapı : Ø12,7	191419811, 22190090617 6N0419811, 6N0422811 XA2084
	VW2022 ROTBAŞI SAĞ RD0336	Ağırlık : 0,357 kg / 0.787 lb Uzunluk : 93,5 mm / 3.68 inch Gövde Diş Çapı : M14X1,5 Aşık Diş Çapı : M12X1,5 Aşık Konik Çapı : Ø12,6	6E0419812, 6K0422812 6X0422812, 8Z0419812A
	VW2023 ROTBAŞI SOL RD0335	Ağırlık : 0,354 kg / 0.780 lb Uzunluk : 93,5 mm / 3.68 inch Gövde Diş Çapı : M14X1,5 Aşık Diş Çapı : M12X1,5 Aşık Konik Çapı : Ø12,6	6E0419811, 6K0422811 6X0422811, 8Z0419811A











* Bu sayfada ve katalogdaki tüm araçların adları, markaları, modelleri, sembolleri, logoları, orjinal numaraları (oe) ve diğer üçüncü parti numaraları sadece referans amaçlı kullanılmaktadır.

LUPO
6X1, 6E1
1998 - 2005

Resim	Ürün Kodu ve Açıklaması	Detay	OEM
	SK3003 ROTMİLİ SAĞ-SOL 297	Ağırlık : 0,552 kg / 1.217 lb Uzunluk : 297 mm / 11.69 inch Gövde Diş Çapı : M14X1,5 Aşık Diş Çapı : M14X1,5	6Q0 423 821 B, 6Q0423821B 6X0422803, 6X0422804 6X0422807, 6X0422821
	SK3007 ROTMİLİ SAĞ-SOL	Ağırlık : 0,561 kg / 1.237 lb Uzunluk : 311 mm / 12.24 inch Gövde Diş Çapı : M14X1,5 Aşık Diş Çapı : M14X1,5	6Q0419803B, 6Q0419803D 6Q0419803F, 6Q0419804B 6Q0419804D, 6Q0419804F
	VW3015 ROTMİLİ SAĞ-SOL HİDROLİK 309 RD0867	Ağırlık : 0,592 kg / 1.305 lb Uzunluk : 313 mm / 12.32 inch Gövde Diş Çapı : M14X1,5 Aşık Diş Çapı : M14X1,5	6N0422803A, 6N0422804A 6N0422807A, 6N0422821A 6X0422821
	VW3016 ROTMİLİ SAĞ-SOL MANUEL 321 RD0864	Ağırlık : 0,602 kg / 1.327 lb Uzunluk : 296 mm / 11.65 inch Gövde Diş Çapı : M22X1,5 Aşık Diş Çapı : M14X1,5	6N0419803, 6N0419804 6N0419821
	VW3018 ROTMİLİ ÖN SAĞ-SOL	Ağırlık : 0,552 kg / 1.217 lb Uzunluk : 297 mm / 11.69 inch Gövde Diş Çapı : M14X1,5 Aşık Diş Çapı : M14X1,5	6X0422803, 6X0422804 6X0422807, 6X0422821
	VW3022 ROTMİLİ SAĞ-SOL L=292MM	Ağırlık : 0,57 kg / 1.257 lb Uzunluk : 292 mm / 11.50 inch Gövde Diş Çapı : M14X1,5 Aşık Diş Çapı : M14X1,5	6N0422803C*, 6N0422803C 6N0422804C*, 6N0422804C
	SK20033007 ROT TAKIMI ÖN AKS SAĞ	Ağırlık : 0,96 kg / 2.116 lb Rotbaşı : SK2003 Rotmili : SK3007	
	SK20043007 ROT TAKIMI ÖN AKS SOL	Ağırlık : 0,96 kg / 2.116 lb Rotbaşı : SK2004 Rotmili : SK3007	
	VW20063015 ROT TAKIMI ÖN AKS SAĞ RD088165	Ağırlık : 0,89 kg / 1.962 lb Rotbaşı : VW2006 Rotmili : VW3015	6N0422804A
	VW20063016 ROT TAKIMI ÖN AKS SAĞ RD088163	Ağırlık : 0,91 kg / 2.006 lb Rotbaşı : VW2006 Rotmili : VW3016	3A0419804, 6N0419804 6N0419804A, 6X0419804A
	VW20073015 ROT TAKIMI ÖN AKS SOL RD088166	Ağırlık : 0,893 kg / 1.969 lb Rotbaşı : VW2007 Rotmili : VW3015	6N0422803A

* Bu sayfada ve katalogdaki tüm araçların adları, markaları, modelleri, sembolleri, logoları, orijinal numaraları (oe) ve diğer üçüncü parti numaraları sadece referans amaçlı kullanılmaktadır.

LUPO
6X1, 6E1
1998 - 2005

Resim	Ürün Kodu ve Açıklaması	Detay	OEM
	VW20073016 ROT TAKIMI ÖN AKS SOL RD088145	Ağırlık : 0,916 kg / 2.019 lb Rotbaşı : VW2007 Rotmili : VW3016	155422803, 175422803 55422803A, 6N0419803A 6X0419803A
	VW20223022 ROT TAKIMI ÖN AKS SAĞ	Ağırlık : 0,94 kg / 2.072 lb Rotbaşı : VW2022 Rotmili : VW3022	6N0422804C
	VW2022SK3003 ROT TAKIMI ÖN SAĞ	Ağırlık : 0,89 kg / 1.962 lb Rotbaşı : VW2022 Rotmili : SK3003	6N0422804
	VW20233022 ROT TAKIMI SOL	Ağırlık : 0,94 kg / 2.072 lb Rotbaşı : VW2023 Rotmili : VW3022	6N0422803C
	VW2023SK3003 ROT TAKIMI ÖN SOL	Ağırlık : 0,89 kg / 1.962 lb Rotbaşı : VW2023 Rotmili : SK3003	6N0422803
	VW4022 Z ROT ÖN SAĞ-SOL 18MM 75 RD0931	Ağırlık : 0,166 kg / 0.366 lb Malzeme Türü : Metal Uzunluk : 76 mm / 2.99 inch Aşık Dış Çapı : M8X1,25	6N0411315A, 6N0411315D
	VW4025 Z ROT ÖN SAĞ-SOL 15MM 75 RD0925	Ağırlık : 0,173 kg / 0.381 lb Uzunluk : 30 mm / 1.18 inch	6N0411315
	VW4028 Z ROT ÖN PLASTİK D = 18 MM	Ağırlık : 0,1 kg / 0.220 lb Malzeme Türü : Plastik Uzunluk : 51,5 mm / 2.03 inch Not : D = 18 mm	6E0411315
	VW6025 SALINCAK ÖN SAĞ	Ağırlık : 2,484 kg / 5.476 lb Malzeme Türü : Sac Metal	
	VW6025J SALINCAK ÖN	Ağırlık : 1,932 kg / 4.259 lb Malzeme Türü : Sac Metal	6N0407151, 6N0407151A 6X0407151, 6X0407151A
	VW6026 SALINCAK ÖN SOL	Ağırlık : 2,484 kg / 5.476 lb Malzeme Türü : Sac Metal	

* Bu sayfada ve katalogdaki tüm araçların adları, markaları, modelleri, sembolleri, logoları, orjinal numaraları (oe) ve diğer üçüncü parti numaraları sadece referans amaçlı kullanılmaktadır.

LUPO
6X1, 6E1
1998 - 2005

Resim	Ürün Kodu ve Açıklaması	Detay	OEM
	VW11022 SALINCAK VE DENGE KOLU BURCU ORTA SOL VE SAĞ B40122	Yön : Orta Sol Ve Sağ Ağırlık : 0,081 kg / 0.179 lb	6N0407182
	VW11041 SALINCAK VE DENGE KOLU BURCU SOL VE SAĞ B40121	Yön : Sol Ve Sağ Ağırlık : 0,156 kg / 0.344 lb	, 6N0407181
	VW12068 TORSİYON BURCU ARKA SOL VE SAĞ	Şasi (Ön / Arka) : ARKA Yön : Sol Ve Sağ Ağırlık : 0.166 kg / 0.366 lb	6N0501541, 6N0501541D
	VW12068K TORSİYON BURCU ARKA SOL VE SAĞ	Şasi (Ön / Arka) : ARKA Yön : Sol Ve Sağ Ağırlık : 0.332 kg / 0.732 lb	6N0501541, 6N0501541D
	VW12111 VİRAJ DEMİR LASTİĞİ SOL VE SAĞ RUBBER	Şasi (Ön / Arka) : ÖN Yön : Sol Ve Sağ Ağırlık : 0.015 kg / 0.033 lb Malzeme Türü : Rubber Not : VİRAJ LASTİĞİ	191411329, 6N0411329
	VW12111K VİRAJ DEMİR LASTİĞİ SOL VE SAĞ RUBBER	Şasi (Ön / Arka) : ÖN Yön : Sol Ve Sağ Ağırlık : 0.03 kg / 0.066 lb Malzeme Türü : Rubber	191411329*, 6N0411329*
	VW12072 MOTOR TAKOZU SOL VE SAĞ ŞANZİMAN TAKOZU	Yön : Sol Ve Sağ Ağırlık : 1.628 kg / 3.589 lb Not : ŞANZİMAN TAKOZU	6N0199555H
	VW12079 MOTOR TAKOZU SOL VE SAĞ ŞANZUMAN TAKOZU	Yön : Sol Ve Sağ Ağırlık : 1.44 kg / 3.175 lb Not : ŞANZUMAN TAKOZU	6N0199555AA, 6N0199555E 6N0199555F, 6N0199555G
	VW13007 DİREKSİYON KÖRÜĞÜ	Ağırlık : 0.128 kg / 0.282 lb	6N0422831
	F114014 AKS KÖRÜĞÜ +KELEPÇE+YAĞ. DIŞ	Ağırlık : 0.211 kg / 0.465 lb	46307841

MULTIVAN
V 7HM, 7HN, 7HF, 7EF, 7EM, 7E
2003 - 2015

Resim	Ürün Kodu ve Açıklaması	Detay	OEM
	VW1024 ROTİL ALT SAĞ-SOL RD0534	Ağırlık : 0,611 kg / 1.347 lb Konik Ölçüsü : Ø18,3 Aşık Diş Çapı : M14X1,5	7E0407361, 7H0407361 7H0407361A
	VW1030 ROTİL ALT	Ağırlık : 0,552 kg / 1.217 lb Konik Ölçüsü : Ø18,3 Bağlantı Delik Çapı : Ø13 Aşık Diş Çapı : M14X1,5	7H8407361, 7H8407361A
	VW1030K ROTİL ÖN ALT Ø18,3	Ağırlık : 0,600 kg / 1.323 lb Konik Ölçüsü : Ø18,3 Bağlantı Delik Çapı : Ø13 Aşık Diş Çapı : M14X1,5	7H8407361, 7H8407361A
	VW2016 ROTBAŞI SAĞ RD0345	Ağırlık : 1,071 kg / 2.361 lb Uzunluk : 235 mm / 9.25 inch Gövde Diş Çapı : M16X1,5 Aşık Diş Çapı : M14X1,5 Aşık Konik Çapı : Ø16,6	1H0422818E, 7H0422818B 7H0422818C
	VW2017 ROTBAŞI SOL RD0344	Ağırlık : 1,062 kg / 2.341 lb Uzunluk : 235 mm / 9.25 inch Gövde Diş Çapı : M16X1,5 Aşık Diş Çapı : M14X1,5 Aşık Konik Çapı : Ø16,6	7H0422817, 7H0422817A 7H0422817B, 7H0422817C
	VW3013 ROTMİLİ SAĞ- SOL M16X1,5 RHT , L= 190 MM	Ağırlık : 0,57 kg / 1.257 lb Uzunluk : 177 mm / 6.97 inch Gövde Diş Çapı : M16X1,5 Aşık Diş Çapı : M16X1,5	7H0419 821D, 7H0419803C* 7H0419803D, 7H0419804C* 7H0422 817C
	VW20163013 ROT TAKIMI ÖN AKS SAĞ RD088221	Ağırlık : 1,543 kg / 3.402 lb Rotbaşı : VW2016 Rotmilî : VW3013	7H0419804 D, 7H0419804C 7H0419804D, 7H0419804F
	VW20173013 ROT TAKIMI ÖN AKS SOL RD088222	Ağırlık : 1,668 kg / 3.677 lb Rotbaşı : VW2017 Rotmilî : VW3013	7H0419803 D, 7H0419803D 7H0419804C
	VW4019 Z ROT SAĞ-SOL METAL RD0934	Ağırlık : 0,39 kg / 0.860 lb Malzeme Türü : Metal Uzunluk : 261 mm / 10.28 inch Aşık Diş Çapı : M12X1,5	1H0411317, 7H0411317 7H5411317, 7H5411317A 7H5411317B
	VW6037 SALINCAĞ ALT SAĞ RD1037	Ağırlık : 8,6 kg / 18.960 lb Malzeme Türü : Döküm Çelik	7H0407152E
	VW6038 SALINCAĞ ALT SOL RD1038	Ağırlık : 8,6 kg / 18.960 lb Malzeme Türü : Döküm Çelik	7H0407151E







* Bu sayfada ve katalogdaki tüm araçların adları, markaları, modelleri, sembolleri, logoları, orjinal numaraları (oe) ve diğer üçüncü parti numaraları sadece referans amaçlı kullanılmaktadır.

MULTIVAN
V 7HM, 7HN, 7HF, 7EF, 7EM, 7E
2003 - 2015



Resim	Ürün Kodu ve Açıklaması	Detay	OEM
	VW6061 SALINCAK ALT SAĞ	Ağırlık : 8,026 kg / 17.694 lb Malzeme Türü : Döküm Çelik	7E0407152B
	VW6062 SALINCAK ALT SOL	Ağırlık : 8,026 kg / 17.694 lb Malzeme Türü : Döküm Çelik	7E0407151C
	VW11062 SALINCAK VE DENGE KOLU BURCU SOL VE SAĞ	Yön : Sol Ve Sağ Ağırlık : 0,294 kg / 0.648 lb	7H0407182A
	VW11064 SALINCAK VE DENGE KOLU BURCU ORTA SOL VE SAĞ B40130	Yön : Orta Sol Ve Sağ Ağırlık : 0.31 kg / 0.683 lb	2H0407183A, 7H0407183
	VW12042 VİRAJ DEMİR LASTİĞİ SOL VE SAĞ RUBBER	Şasi (Ön / Arka) : ÖN Yön : Sol Ve Sağ Ağırlık : 0.05 kg / 0.110 lb Malzeme Türü : Rubber Not : VİRAJ LASTİĞİ	7H5411313A, 7H5411313B
	VW12042K VİRAJ DEMİR LASTİĞİ SOL VE SAĞ RUBBER	Şasi (Ön / Arka) : ÖN Yön : Sol Ve Sağ Ağırlık : 0.1 kg / 0.220 lb Malzeme Türü : Rubber	7H5411313A*
	VW12063 VİRAJ DEMİR LASTİĞİ SOL VE SAĞ RUBBER	Şasi (Ön / Arka) : ÖN Yön : Sol Ve Sağ Ağırlık : 0.054 kg / 0.119 lb Malzeme Türü : Rubber Not : VİRAJ LASTİĞİ	7H0411313
	VW12063K VİRAJ DEMİR LASTİĞİ SOL VE SAĞ RUBBER	Şasi (Ön / Arka) : ÖN Yön : Sol Ve Sağ Ağırlık : 0.108 kg / 0.238 lb Malzeme Türü : Rubber	7H0411313*
	VW12090 VİRAJ DEMİR LASTİĞİ SOL VE SAĞ RUBBER	Şasi (Ön / Arka) : ÖN Yön : Sol Ve Sağ Ağırlık : 0.04 kg / 0.088 lb Malzeme Türü : Rubber Not : VİRAJ LASTİĞİ ARKA Ø27	7H5511414A
	VW12090K VİRAJ DEMİR LASTİĞİ SOL VE SAĞ RUBBER	Şasi (Ön / Arka) : ÖN Yön : Sol Ve Sağ Ağırlık : 0.08 kg / 0.176 lb Malzeme Türü : Rubber	7H5511414A*
	VW12018 AMORTİSÖR TAKOZU SOL VE SAĞ AMORTİSÖR TAKOZU	Yön : Sol Ve Sağ Ağırlık : 0.556 kg / 1.226 lb Not : AMORTİSÖR TAKOZU	7E0412331

* Bu sayfada ve katalogdaki tüm araçların adları, markaları, modelleri, sembolleri, logoları, orijinal numaraları (oe) ve diğer üçüncü parti numaraları sadece referans amaçlı kullanılmaktadır.

MULTIVAN
V 7HM, 7HN, 7HF, 7EF, 7EM, 7E
2003 - 2015







Resim	Ürün Kodu ve Açıklaması	Detay	OEM
	VW12018K AMORTİSÖR TAKOZU SOL VE SAĞ AMORTİSÖR TAKOZU ÖN RULMANLI	Yön : Sol Ve Sağ Ağırlık : 0.815 kg / 1.797 lb Not : AMORTİSÖR TAKOZU ÖN RULMANLI	7E0412331, 7E0412331S1 7H0412249A
	VW12018R AMORTİSÖR TAKOZU SOL VE SAĞ AMORTİSÖR TAKOZU RULMANI	Yön : Sol Ve Sağ Ağırlık : 0.259 kg / 0.571 lb Not : AMORTİSÖR TAKOZU RULMANI	7E0412249, 7H0412249 7H0412249A
	VW12023 ŞANZIMAN TAKOZU SOL VE SAĞ ŞANZUMAN TAKOZU ARKA	Yön : Sol Ve Sağ Ağırlık : 1.25 kg / 2.756 lb Not : ŞANZUMAN TAKOZU ARKA	7H0199849, 7H0199849AT
	SK12006 EGZOZ TAKOZU	Ağırlık : 0,185 kg / 0.408 lb	6Q0253144B, 6Q0253144D
	VW13004 RIW DİREKSİYON KÖRÜĞÜ	Ağırlık : 0.16 kg / 0.353 lb	7H0422831
	RN14016 AKS KÖRÜĞÜ +KELEPÇE+YAĞ. DIŞ	Ağırlık : 0.26 kg / 0.573 lb	7701209568, 7H0498103E 7H0498202A
	VW15001 AMORTİSÖR KÖRÜĞÜ ÖN	Şasi (Ön / Arka) : ÖN Ağırlık : 0,095 kg / 0.209 lb	7H0412137

MULTIVAN
VI SGF, SGM, SGN
2011 -





Resim	Ürün Kodu ve Açıklaması	Detay	OEM
	VW2016 ROTBAŞI SAĞ RD0345	Ağırlık : 1,071 kg / 2.361 lb Uzunluk : 235 mm / 9.25 inch Gövde Diş Çapı : M16X1,5 Aşık Diş Çapı : M14X1,5 Aşık Konik Çapı : Ø16,6	1H0422818E, 7H0422818B 7H0422818C
	VW2017 ROTBAŞI SOL RD0344	Ağırlık : 1,062 kg / 2.341 lb Uzunluk : 235 mm / 9.25 inch Gövde Diş Çapı : M16X1,5 Aşık Diş Çapı : M14X1,5 Aşık Konik Çapı : Ø16,6	7H0422817, 7H0422817A 7H0422817B, 7H0422817C
	VW3013 ROTMİLİ SAĞ- SOL M16X1,5 RHT , L= 190 MM	Ağırlık : 0,57 kg / 1.257 lb Uzunluk : 177 mm / 6.97 inch Gövde Diş Çapı : M16X1,5 Aşık Diş Çapı : M16X1,5	7H0419 821D, 7H0419803C* 7H0419803D, 7H0419804C* 7H0422 817C

* Bu sayfada ve katalogdaki tüm araçların adları, markaları, modelleri, sembolleri, logoları, orjinal numaraları (oe) ve diğer üçüncü parti numaraları sadece referans amaçlı kullanılmaktadır.

MULTIVAN
VI SGF, SGM, SGN
2011 -











Resim	Ürün Kodu ve Açıklaması	Detay	OEM
	VW20163013 ROT TAKIMI ÖN AKS SAĞ RD088221	Ağırlık : 1,543 kg / 3.402 lb Rotbaşı : VW2016 Rotmilii : VW3013	7H0419804 D, 7H0419804C 7H0419804D, 7H0419804F
	VW20173013 ROT TAKIMI ÖN AKS SOL RD088222	Ağırlık : 1,668 kg / 3.677 lb Rotbaşı : VW2017 Rotmilii : VW3013	7H0419803 D, 7H0419803D 7H0419804C
	VW4019 Z ROT SAĞ-SOL METAL RD0934	Ağırlık : 0,39 kg / 0.860 lb Malzeme Türü : Metal Uzunluk : 261 mm / 10.28 inch Aşık Diş Çapı : M12X1,5	1H0411317, 7H0411317 7H5411317, 7H5411317A 7H5411317B
	VW12090 VİRAJ DEMİR LASTİĞİ SOL VE SAĞ RUBBER	Şasi (Ön / Arka) : ÖN Yön : Sol Ve Sağ Ağırlık : 0.04 kg / 0.088 lb Malzeme Türü : Rubber Not : VİRAJ LASTİĞİ ARKA Ø27	7H5511414A
	VW12090K VİRAJ DEMİR LASTİĞİ SOL VE SAĞ RUBBER	Şasi (Ön / Arka) : ÖN Yön : Sol Ve Sağ Ağırlık : 0.08 kg / 0.176 lb Malzeme Türü : Rubber	7H5511414A*
	VW15001 AMORTİSÖR KÖRÜĞÜ ÖN	Şasi (Ön / Arka) : ÖN Ağırlık : 0,095 kg / 0.209 lb	7H0412137

NOVO FUSCA
5C1, 5C2
2012 - 2019

Resim	Ürün Kodu ve Açıklaması	Detay	OEM
	VW1014 ROTİL ÖN ALT SAĞ Ø15,6 RB2536	Ağırlık : 0,565 kg / 1.246 lb Konik Ölçüsü : Ø15,6 Bağlantı Delik Çapı : Ø10,5 Aşık Diş Çapı : M12X1,5	1K0407366B, 1K0407366C 1K0407366E, 5Q0407366A
	VW1015 ROTİL ÖN ALT SOL Ø15,6 RB2537	Ağırlık : 0,565 kg / 1.246 lb Konik Ölçüsü : Ø15,6 Bağlantı Delik Çapı : Ø10,5 Aşık Diş Çapı : M12X1,5	1K0407365B, 1K0407365C 1K0407365E, 5Q0407365A
	VW2008 ROTBAŞI ÖN SAĞ RD0342	Ağırlık : 0,412 kg / 0.908 lb Uzunluk : 95 mm / 3.74 inch Gövde Diş Çapı : M16X1,5 Aşık Diş Çapı : M12X1,5 Aşık Konik Çapı : Ø12,7	1K0423812A, 1K0423812C 1K0423812E, 1K0423812G 1K0423812J, 1K0423812K 1KD423812A
	VW2009 ROTBAŞI ÖN SOL RD0343	Ağırlık : 0,412 kg / 0.908 lb Uzunluk : 95 mm / 3.74 inch Gövde Diş Çapı : M16X1,5 Aşık Diş Çapı : M12X1,5 Aşık Konik Çapı : Ø13,5	1K0423811A, 1K0423811C 1K0423811E, 1K0423811G 1K0423811J, 1K0423811K 1KD423811A









* Bu sayfada ve katalogdaki tüm araçların adları, markaları, modelleri, sembolleri, logoları, orjinal numaraları (oe) ve diğer üçüncü parti numaraları sadece referans amaçlı kullanılmaktadır.

NOVO FUSCA
5C1, 5C2
2012 - 2019

Resim	Ürün Kodu ve Açıklaması	Detay	OEM
	VW3021 ROTMİLİ SAĞ-SOL	Ağırlık : 0,705 kg / 1.554 lb Uzunluk : 330 mm / 12.99 inch	561423810
	VW20083021 ROT TAKIMI ÖN AKS SAĞ	Ağırlık : 1,2 kg / 2.646 lb Rotbaşı : VW2008 Rotmilî : VW3021	561423810, 561423810S1
	VW20093021 ROT TAKIMI ÖN SOL	Ağırlık : 1,2 kg / 2.646 lb Rotbaşı : VW2009 Rotmilî : VW3021	561423810 S2, 561423810
	VW4014 Z ROT ÖN SAĞ-SOL METAL 335 RB2935	Ağırlık : 0,46 kg / 1.014 lb Malzeme Türü : Metal Uzunluk : 335 mm / 13.19 inch Aşık Diş Çapı : M12X1,5	1K0411315B, 1K0411315D 1K0411315J, 1K0411315K 1K0411315R, 5Q0411315A 5Q0411315B
	VW4015 Z ROT SOL VE SAĞ METAL RB2937	Ağırlık : 0,373 kg / 0.822 lb Malzeme Türü : Metal Uzunluk : 95,5 mm / 3.76 inch Aşık Diş Çapı : M10X1,5	1K0505465C, 1K0505465D 1K0505465H, 1K0505465J 1K0505465K
	VW4015K Z ROT SOL VE SAĞ METAL	Ağırlık : 0,373 kg / 0.822 lb Malzeme Türü : Metal Uzunluk : 95,5 mm / 3.76 inch Aşık Diş Çapı : M10X1,5	1K0505465C, 1K0505465D 1K0505465H, 1K0505465J 1K0505465K
	SK9001 SALINCAK ARKA ALT	Ağırlık : 0,701 kg / 1.545 lb Malzeme Türü : Sac Metal	1K0501529J
	VW6053 SALINCAK ÖN SAĞ	Ağırlık : 3,77 kg / 8.311 lb Malzeme Türü : Sac Metal	561407152A*
	VW6053J SALINCAK ALT SAĞ	Ağırlık : 3,119 kg / 6.876 lb Malzeme Türü : Sac Metal	561407152A
	VW6054 SALINCAK ÖN SOL	Ağırlık : 3,77 kg / 8.311 lb Malzeme Türü : Sac Metal	561407151A*
	VW6054J SALINCAK ÖN SOL	Ağırlık : 3,119 kg / 6.876 lb Malzeme Türü : Sac Metal	561407151, 561407151A

* Bu sayfada ve katalogdaki tüm araçların adları, markaları, modelleri, sembolleri, logoları, orjinal numaraları (oe) ve diğer üçüncü parti numaraları sadece referans amaçlı kullanılmaktadır.

NOVO FUSCA
5C1, 5C2
2012 - 2019

Resim	Ürün Kodu ve Açıklaması	Detay	OEM
	VW9001 SALINCAK ARKA	Ağırlık : 2,55 kg / 5.622 lb Malzeme Türü : Sac Metal	1K0505311AA, 1K0505311ABÂ 1K0505311H, 1K0505311S 1K0505311T
	VW9002 SALINCAK ÖN TARAF SAĞ	Ağırlık : 1,79 kg / 3.946 lb Malzeme Türü : Sac Metal	1K0505224E, 1K0505224H 1K0505224K
	VW9003 SALINCAK ÖN TARAF SOL	Ağırlık : 1,79 kg / 3.946 lb Malzeme Türü : Sac Metal	1K0505223E, 1K0505223H 1K0505223K
	AU11035 SALINCAK VE DENGE KOLU BURCU ARKA SOL VE SAĞ	Şasi (Ön / Arka) : ARKA Yön : Sol Ve Sağ Ağırlık : 0,25 kg / 0.551 lb	1K0505171C
	AU11052 SALINCAK VE DENGE KOLU BURCU SOL VE SAĞ	Yön : Sol Ve Sağ Ağırlık : 0,178 kg / 0.392 lb	1K0505541B, 1K0505541C 1K0505541D
	AU11088 SALINCAK VE DENGE KOLU BURCU ARKA	Şasi (Ön / Arka) : ARKA Ağırlık : 0,165 kg / 0.364 lb	1K0505541C, 1K0505541D 3C0505541
	SK11009 SALINCAK VE DENGE KOLU BURCU ARKA SOL VE SAĞ	Şasi (Ön / Arka) : ARKA Yön : Sol Ve Sağ Ağırlık : 0,176 kg / 0.388 lb	1K0501529J*
	SK11010 SALINCAK VE DENGE KOLU BURCU ARKA SOL VE SAĞ	Şasi (Ön / Arka) : ARKA Yön : Sol Ve Sağ Ağırlık : 0,196 kg / 0.432 lb Not : BÜYÜK	1K0501529J*
	VW11071 SALINCAK VE DENGE KOLU BURCU SOL VE SAĞ	Yön : Sol Ve Sağ Ağırlık : 0,294 kg / 0.648 lb	
	VW11180 Z-ROT BURCU ARKA	Şasi (Ön / Arka) : ARKA Ağırlık : 0.069 kg / 0.152 lb Uzunluk : VW4015 mm / 0.00 inch Aşık Dış Çapı : VW4015K	1K0505465C*, 1K0505465D* 1K0505465H*, 1K0505465J* 1K0505465K*

* Bu sayfada ve katalogdaki tüm araçların adları, markaları, modelleri, sembolleri, logoları, orjinal numaraları (oe) ve diğer üçüncü parti numaraları sadece referans amaçlı kullanılmaktadır.

PASSAT
1988 - 1996

Resim	Ürün Kodu ve Açıklaması	Detay	OEM
	RD0856 ROTMİLİ SAĞ-SOL 369	Uzunluk : 369 mm / 14.53 inch	357422821B





PASSAT
1991 - 1996

Resim	Ürün Kodu ve Açıklaması	Detay	OEM
	RD0856 ROTMİLİ SAĞ-SOL 369	Uzunluk : 369 mm / 14.53 inch	357422821B

PASSAT
1994 - 1997

Resim	Ürün Kodu ve Açıklaması	Detay	OEM
	RD0856 ROTMİLİ SAĞ-SOL 369	Uzunluk : 369 mm / 14.53 inch	357422821B

PASSAT
B2
1980 - 1988

Resim	Ürün Kodu ve Açıklaması	Detay	OEM
	AU1002 ROTİL ÖN SAĞ - SOL RB2512	Ağırlık : 0,46 kg / 1.014 lb Bağlantı Delik Çapı : Ø10,5	321413025B, 321413026B 823407365E
	AU1003 ROTİL ÖN SAĞ RB2515	Ağırlık : 0,58 kg / 1.279 lb Bağlantı Delik Çapı : Ø10,5	855407366A, 855407366B
	AU1004 ROTİL ÖN SOL RB2514	Ağırlık : 0,58 kg / 1.279 lb Bağlantı Delik Çapı : Ø10,5	855407365A, 855407365B
	AU2311 ROTBAŞI ÖN SAĞ - SOL RB2311	Ağırlık : 0,218 kg / 0.481 lb Uzunluk : 75 mm / 2.95 inch Gövde Diş Çapı : M14X1,5 Aşık Diş Çapı : M10X1 Aşık Konik Çapı : Ø11	811419812A, 811419812B 8A0419812
	AU6002 SALINCAK ÖN SAĞ	Ağırlık : 2,816 kg / 6.208 lb Malzeme Türü : Sac Metal	893407148C*

* Bu sayfada ve katalogdaki tüm araçların adları, markaları, modelleri, sembolleri, logoları, orjinal numaraları (oe) ve diğer üçüncü parti numaraları sadece referans amaçlı kullanılmaktadır.

PASSAT
B2
1980 - 1988

Resim	Ürün Kodu ve Açıklaması	Detay	OEM
	AU6002J SALINCAK ÖN SAĞ RB3105	Ağırlık : 2,226 kg / 4.907 lb Malzeme Türü : Sac Metal	893407148C
	AU6003 SALINCAK ÖN SOL	Ağırlık : 2,816 kg / 6.208 lb Malzeme Türü : Sac Metal	893407147C*
	AU6003J SALINCAK ÖN SOL RB3106	Ağırlık : 2,147 kg / 4.733 lb Malzeme Türü : Sac Metal	893407147C, 893407147E
	AU6004J SALINCAK ÖN SAĞ RB3107	Ağırlık : 2,185 kg / 4.817 lb Malzeme Türü : Sac Metal	893407148E
	AU6005J SALINCAK ÖN SOL	Ağırlık : 2,178 kg / 4.802 lb Malzeme Türü : Sac Metal	893407147E
	AU11001 SALINCAK VE DENGE KOLU BURCU ÖN İÇ SOL VE SAĞ B22128	Şasi (Ön / Arka) : ÖN Yön : İç Sol Ve Sağ Ağırlık : 0,158 kg / 0.348 lb Not : L=44mm/İN D=Ø10,2mm/O D=Ø37,1m	857407181, 8A0407181
	VW12158 BEŞİK (TRAVERS) BURCU ARKA SOL VE SAĞ	Şasi (Ön / Arka) : ARKA Yön : Sol Ve Sağ Ağırlık : 0.22 kg / 0.485 lb	321501541
	AU12007 VİRAJ DEMİR LASTİĞİ SOL VE SAĞ RUBBER	Şasi (Ön / Arka) : ÖN Yön : Sol Ve Sağ Ağırlık : 0,02 kg / 0.044 lb Malzeme Türü : Rubber	823411327B
	AU12007K VİRAJ DEMİR LASTİĞİ SOL VE SAĞ RUBBER	Şasi (Ön / Arka) : ÖN Yön : Sol Ve Sağ Ağırlık : 0.04 kg / 0.088 lb Malzeme Türü : Rubber	823411327B*, 823411327B
	AU12008 VİRAJ DEMİR LASTİĞİ SOL VE SAĞ RUBBER	Şasi (Ön / Arka) : ÖN Yön : Sol Ve Sağ Ağırlık : 0,03 kg / 0.066 lb Malzeme Türü : Rubber	823411313A*, 823411313A
	AU12008K VİRAJ DEMİR LASTİĞİ SOL VE SAĞ RUBBER	Şasi (Ön / Arka) : ÖN Yön : Sol Ve Sağ Ağırlık : 0.06 kg / 0.132 lb Malzeme Türü : Rubber	823411313A*



* Bu sayfada ve katalogdaki tüm araçların adları, markaları, modelleri, sembolleri, logoları, orjinal numaraları (oe) ve diğer üçüncü parti numaraları sadece referans amaçlı kullanılmaktadır.

PASSAT
B2
1980 - 1988







Resim	Ürün Kodu ve Açıklaması	Detay	OEM
	VW12104 AMORTİSÖR TAKOZU SOL VE SAĞ AMORTİSOR TABLASI	Yön : Sol Ve Sağ Ağırlık : 0,257 kg / 0.567 lb Not : AMORTİSOR TABLASI	811412323C, 811412323D 8A0412323B, 8A0412323D
	VW12104K AMORTİSÖR TAKOZU SOL VE SAĞ 2 PCS	Yön : Sol Ve Sağ Ağırlık : 0,514 kg / 1.133 lb Not : 2 PCS	811412323C, 811412323D 8A0412323B, 8A0412323D
	AU12009 MOTOR TAKOZU ÖN SOL VE SAĞ	Şasi (Ön / Arka) : ÖN Yön : Sol Ve Sağ Ağırlık : 0,464 kg / 1.023 lb	823199381B, 893199381B
	AU12013 MOTOR TAKOZU ÖN SOL VE SAĞ VERS BURCU	Şasi (Ön / Arka) : ÖN Yön : Sol Ve Sağ Ağırlık : 0,129 kg / 0.284 lb Not : VERS BURCU	811199415A, 893199415
	AU12014 MOTOR TAKOZU ÖN SOL VE SAĞ TRAVERS BURCU ARKA	Şasi (Ön / Arka) : ÖN Yön : Sol Ve Sağ Ağırlık : 0,118 kg / 0.260 lb Not : TRAVERS BURCU ARKA	811199419B, 811199419C 893199419
	AU12011 ŞANZIMAN TAKOZU SOL VE SAĞ ŞANZUMAN TAKOZU	Şasi (Ön / Arka) : ÖN Yön : Sol Ve Sağ Ağırlık : 0,26 kg / 0.573 lb Not : ŞANZUMAN TAKOZU	811399151B
	AU12016 ŞANZIMAN TAKOZU SOL VE SAĞ ŞANZUMAN TAKOZU	Yön : Sol Ve Sağ Ağırlık : 0,267 kg / 0.589 lb Not : ŞANZUMAN TAKOZU	431399151D
	AU12034 ŞANZIMAN TAKOZU	Ağırlık : 0,556 kg / 1.226 lb	811199339A, 811199339B 823199339A
	AU12012 EGSOZ TAKOZU ÖN SOL VE SAĞ EGSOZ LASTİĞİ	Şasi (Ön / Arka) : ÖN Yön : Sol Ve Sağ Ağırlık : 0,034 kg / 0.075 lb Not : EGSOZ LASTİĞİ	191253147B, 4A0253147A
	VW13008 DİREKSİYON KÖRÜĞÜ	Ağırlık : 0,225 kg / 0.496 lb	1H0422831B
	OP14003 AKS KÖRÜĞÜ +KELEPÇE+YAĞ. AKS KÖRÜĞÜ DIŞ	Ağırlık : 0,2 kg / 0.441 lb	1603180

* Bu sayfada ve katalogdaki tüm araçların adları, markaları, modelleri, sembolleri, logoları, orjinal numaraları (oe) ve diğer üçüncü parti numaraları sadece referans amaçlı kullanılmaktadır.

PASSAT
B2
1980 - 1988











Resim	Ürün Kodu ve Açıklaması	Detay	OEM
	RN14006 AKS KÖRÜĞÜ +KELEPÇE+YAĞ. DIŞ	Ağırlık : 0.2 kg / 0.441 lb	1603180, 1603204 16410170470106*, 16500170470106* 1H0498203, 271648 271649, 321498203A 431498203C, 443498203D
	VW14013 AKS KÖRÜĞÜ +KELEPÇE+YAĞ. YAĞ+KELEPÇE	Ağırlık : 0.156 kg / 0.344 lb	113501149, 171407283A
	VW14014 AKS KÖRÜĞÜ +KELEPÇE+YAĞ. YAĞ+KELEPÇE	Ağırlık : 0.28 kg / 0.617 lb	191498203C, 71498203

PASSAT
B3
1988 - 1994

Resim	Ürün Kodu ve Açıklaması	Detay	OEM
	VW1012 ROTİL ALT SOL VE SAĞ	Ağırlık : 0,353 kg / 0.778 lb Bağlantı Delik Çapı : Ø8,5	357407365, 357407365A
	VW1012K ROTİL ALT SAĞ-SOL 19 RD0515	Ağırlık : 0,445 kg / 0.981 lb Bağlantı Delik Çapı : Ø8,5	357407365, 357407365A* 357407365A, 357407365S 357407365-S1
	VW2006 ROTBAŞI SAĞ RD0312	Ağırlık : 0,3 kg / 0.661 lb Uzunluk : 76 mm / 2.99 inch Gövde Diş Çapı : M14X1,5 Aşık Diş Çapı : M12X1,5 Aşık Konik Çapı : Ø12,7	191419812, 22190091617 6N0419812, 6N0422812 XA2087
	VW2007 ROTBAŞI SOL RD0311	Ağırlık : 0,3 kg / 0.661 lb Uzunluk : 76 mm / 2.99 inch Gövde Diş Çapı : M14X1,5 Aşık Diş Çapı : M12X1,5 Aşık Konik Çapı : Ø12,7	191419811, 22190090617 6N0419811, 6N0422811 XA2084
	VW2026 ROTBAŞI DIŞ	Ağırlık : 0.36 kg / 0.794 lb	357422811
	VW3005 ROTMİLİ SAĞ-SOL MANUEL 370 RD0829	Ağırlık : 0,686 kg / 1.512 lb Uzunluk : 387 mm / 15.24 inch Gövde Diş Çapı : M22X1,5 Aşık Diş Çapı : M14X1,5	357419821
	VW3006 ROTMİLİ SAĞ-SOL HİDROLİK 360 RD0832	Ağırlık : 0,714 kg / 1.574 lb Uzunluk : 359 mm / 14.13 inch Gövde Diş Çapı : M14X1,5 Aşık Diş Çapı : M14X1,5	357419823, 357422821

* Bu sayfada ve katalogdaki tüm araçların adları, markaları, modelleri, sembolleri, logoları, orjinal numaraları (oe) ve diğer üçüncü parti numaraları sadece referans amaçlı kullanılmaktadır.

PASSAT
B3
1988 - 1994

Resim	Ürün Kodu ve Açıklaması	Detay	OEM
	VW20063005 ROT TAKIMI ÖN AKS SAĞ RD088128	Ağırlık : 1,081 kg / 2.383 lb Rotbaşı : VW2006 Rotmili : VW3005	357419804
	VW20063006 ROT TAKIMI ÖN AKS SAĞ RD088130	Ağırlık : 1,005 kg / 2.216 lb Rotbaşı : VW2006 Rotmili : VW3006	357422804
	VW20073005 ROT TAKIMI ÖN AKS SOL RD088127	Ağırlık : 0,988 kg / 2.178 lb Rotbaşı : VW2007 Rotmili : VW3005	357419803
	VW20073006 ROT TAKIMI ÖN AKS SOL RD088131	Ağırlık : 1,012 kg / 2.231 lb Rotbaşı : VW2007 Rotmili : VW3006	357422803
	VW4005 Z ROT ÖN SAĞ - SOL 19 MM RD0926	Ağırlık : 0,255 kg / 0.562 lb Malzeme Türü : 19 Mm Uzunluk : 80 mm / 3.15 inch Not : 23,5	357411315C*, 357411415K
	VW4006 Z ROT ÖN SAĞ - SOL 19,8 MM RD0927	Ağırlık : 0,256 kg / 0.564 lb Malzeme Türü : 19,8 Mm Uzunluk : 80 mm / 3.15 inch Aşık Diş Çapı : M10X1,5	357411315D*, 357411315D
	VW4007 Z ROT ÖN SAĞ - SOL METAL 23MM RD0940	Ağırlık : 0,239 kg / 0.527 lb Malzeme Türü : Metal 23Mm Uzunluk : 80 mm / 3.15 inch	357411315*, 357411315
	VW6008 SALINCAK ALT SAĞ RD1032	Ağırlık : 3,267 kg / 7.203 lb Malzeme Türü : Sac Metal	357407151
	VW6008J SALINCAK ÖN RD1109	Ağırlık : 2,802 kg / 6.177 lb Malzeme Türü : Sac Metal	357407151, 357407153
	VW6009 SALINCAK ALT SOL RD1028	Ağırlık : 3,76 kg / 8.289 lb Malzeme Türü : Sac Metal	357407151, 357407152
	AU11005 SALINCAK VE DENGE KOLU BURCU ÖN ORTA SOL VE SAĞ B40115	Şasi (Ön / Arka) : ÖN Yön : Orta Sol Ve Sağ Ağırlık : 0,111 kg / 0.245 lb Not : VW6014 - VW60614J	191407182, 357407182 357407182F

* Bu sayfada ve katalogdaki tüm araçların adları, markaları, modelleri, sembolleri, logoları, orijinal numaraları (oe) ve diğer üçüncü parti numaraları sadece referans amaçlı kullanılmaktadır.

PASSAT
B3
1988 - 1994

Resim	Ürün Kodu ve Açıklaması	Detay	OEM
	VW11001 SALINCAK VE DENGE KOLU BURCU SOL VE SAĞ B40114	Yön : Sol Ve Sağ Ağırlık : 0.141 kg / 0.311 lb	191407181D, 191407181E 357407181
	VW11036 SALINCAK VE DENGE KOLU BURCU SOL VE SAĞ	Yön : Sol Ve Sağ Ağırlık : 0.07 kg / 0.154 lb Not : BORUSU	191411315B, 4A0399413A
	VW11840 BURÇ	Yön : Sol Ve Sağ Ağırlık : 0,149 kg / 0.328 lb	357407181
	VW12130 Z-ROT BURCU ÖN	Şasi (Ön / Arka) : ÖN Ağırlık : 0.04 kg / 0.088 lb	357411315A*, 357411315D*
	VW12130K Z-ROT BURCU ÖN	Şasi (Ön / Arka) : ÖN Ağırlık : 0.08 kg / 0.176 lb	357411315A*, 357411315D*
	VW12011 BEŞİK (TRAVERS) BURCU SOL VE SAĞ	Yön : Sol Ve Sağ Ağırlık : 0.268 kg / 0.591 lb	333501541, 357501541 357501541A, 3A0501541
	VW12011K BEŞİK (TRAVERS) BURCU ARKA SOL VE SAĞ VW12011	Şasi (Ön / Arka) : ARKA Yön : Sol Ve Sağ Ağırlık : 0.536 kg / 1.182 lb	333501541, 357501541 357501541A, 3A0501541
	VW12001 AMORTİSÖR TAKOZU SOL VE SAĞ AMORTİSÖR TAKOZU	Yön : Sol Ve Sağ Ağırlık : 0.644 kg / 1.420 lb Not : AMORTİSÖR TAKOZU	176412329, 191412329 191412331
	VW12006 AMORTİSÖR TAKOZU SOL VE SAĞ AMORTİSÖR ÜST TAKOZU	Yön : Sol Ve Sağ Ağırlık : 0.445 kg / 0.981 lb Not : AMORTİSÖR ÜST TAKOZU	357412331A, 7201848 7M0412331, 95VW3K031AA
	VW12058 AMORTİSÖR TAKOZU SOL VE SAĞ	Yön : Sol Ve Sağ Ağırlık : 0.654 kg / 1.442 lb	357412329
	VW12007 MOTOR TAKOZU SAĞ MOTOR TAKOZU SAĞ	Yön : Sağ Ağırlık : 1,193 kg / 2.630 lb Not : MOTOR TAKOZU SAĞ	91199262A

* Bu sayfada ve katalogdaki tüm araçların adları, markaları, modelleri, sembolleri, logoları, orijinal numaraları (oe) ve diğer üçüncü parti numaraları sadece referans amaçlı kullanılmaktadır.

PASSAT
B3
1988 - 1994

Resim	Ürün Kodu ve Açıklaması	Detay	OEM
	VW12008 MOTOR TAKOZU SOL VE SAĞ MOTOR TAKOZU	Yön : Sol Ve Sağ Ağırlık : 0.574 kg / 1.265 lb Not : MOTOR TAKOZU	357199381C, 357199402B 3A0199402
	VW12074 MOTOR TAKOZU SOL VE SAĞ MOTOR TAKOZU	Yön : Sol Ve Sağ Ağırlık : 1.08 kg / 2.381 lb Not : MOTOR TAKOZU	1H0199609B, 1H0199609F 1H0199609G, 1H0199609J
	VW12092 MOTOR TAKOZU SAĞ MOTOR TAKOZU ARKA SAĞ	Yön : Sağ Ağırlık : 1,745 kg / 3.847 lb Not : MOTOR TAKOZU ARKA SAĞ	1H0199262B, 1H0199262G 1H0199262H
	VW12095 MOTOR TAKOZU SOL VE SAĞ MOTOR TAKOZU	Yön : Sol Ve Sağ Ağırlık : 1,389 kg / 3.062 lb Not : MOTOR TAKOZU	191199272, 191199272A 191199273, 191199279B 191199279C, 191199279D 357199279C
	VW12041 ŞANZIMAN TAKOZU SOL VE SAĞ ŞANZIMAN TAKOZU	Yön : Sol Ve Sağ Ağırlık : 0.307 kg / 0.677 lb Not : ŞANZIMAN TAKOZU	8D0399151J, 8D0399151P
	VW12089 SÜSPANSİYON TAKOZU SOL VE SAĞ SÜSPANSİYON TAKOZU	Yön : Sol Ve Sağ Ağırlık : 0.15 kg / 0.331 lb Not : SÜSPANSİYON TAKOZU	191412303A, 357412303E
	VW13008 DİREKSİYON KÖRÜĞÜ	Ağırlık : 0.225 kg / 0.496 lb	1H0422831B
	VW13010 DİREKSİYON KÖRÜĞÜ ÖN	Ağırlık : 0,124 kg / 0.273 lb	191422831
	OP14003 AKS KÖRÜĞÜ +KELEPÇE+YAĞ. AKS KÖRÜĞÜ DIŞ	Ağırlık : 0.2 kg / 0.441 lb	1603180
	RN14006 AKS KÖRÜĞÜ +KELEPÇE+YAĞ. DIŞ	Ağırlık : 0.2 kg / 0.441 lb	1603180, 1603204 16410170470106*, 16500170470106* 1H0498203, 271648 271649, 321498203A
	VW14008 AKS KÖRÜĞÜ +KELEPÇE+YAĞ. DIŞ		3B0407203A

* Bu sayfada ve katalogdaki tüm araçların adları, markaları, modelleri, sembolleri, logoları, orjinal numaraları (oe) ve diğer üçüncü parti numaraları sadece referans amaçlı kullanılmaktadır.

PASSAT
B3
1988 - 1994











Resim	Ürün Kodu ve Açıklaması	Detay	OEM
	VW14013 AKS KÖRÜĞÜ +KELEPÇE+YAĞ. YAĞ+KELEPÇE	Ağırlık : 0.156 kg / 0.344 lb	113501149, 171407283A
	VW14014 AKS KÖRÜĞÜ +KELEPÇE+YAĞ. YAĞ+KELEPÇE	Ağırlık : 0.28 kg / 0.617 lb	191498203C, 71498203

PASSAT
B4
1994 - 1997

Resim	Ürün Kodu ve Açıklaması	Detay	OEM
	VW1012 ROTİL ALT SOL VE SAĞ	Ağırlık : 0,353 kg / 0.778 lb Bağlantı Delik Çapı : Ø8,5	357407365, 357407365A
	VW1012K ROTİL ALT SAĞ-SOL 19 RD0515	Ağırlık : 0,445 kg / 0.981 lb Bağlantı Delik Çapı : Ø8,5	357407365, 357407365A* 357407365A, 357407365S 357407365-S1
	VW2006 ROTBAŞI SAĞ RD0312	Ağırlık : 0,3 kg / 0.661 lb Uzunluk : 76 mm / 2.99 inch Gövde Diş Çapı : M14X1,5 Aşık Diş Çapı : M12X1,5 Aşık Konik Çapı : Ø12,7	19149812, 22190091617 6N0419812, 6N0422812 XA2087
	VW2007 ROTBAŞI SOL RD0311	Ağırlık : 0,3 kg / 0.661 lb Uzunluk : 76 mm / 2.99 inch Gövde Diş Çapı : M14X1,5 Aşık Diş Çapı : M12X1,5 Aşık Konik Çapı : Ø12,7	19149811, 22190090617 6N0419811, 6N0422811 XA2084
	VW2026 ROTBAŞI DIŞ	Ağırlık : 0.36 kg / 0.794 lb	357422811
	VW3005 ROTMİLİ SAĞ-SOL MANUEL 370 RD0829	Ağırlık : 0,686 kg / 1.512 lb Uzunluk : 387 mm / 15.24 inch Gövde Diş Çapı : M22X1,5 Aşık Diş Çapı : M14X1,5	357419821
	VW3006 ROTMİLİ SAĞ-SOL HİDROLİK 360 RD0832	Ağırlık : 0,714 kg / 1.574 lb Uzunluk : 359 mm / 14.13 inch Gövde Diş Çapı : M14X1,5 Aşık Diş Çapı : M14X1,5	357419823, 357422821
	VW20063005 ROT TAKIMI ÖN AKS SAĞ RD088128	Ağırlık : 1,081 kg / 2.383 lb Rotbaşı : VW2006 Rotmili : VW3005	357419804

* Bu sayfada ve katalogdaki tüm araçların adları, markaları, modelleri, sembolleri, logoları, orijinal numaraları (oe) ve diğer üçüncü parti numaraları sadece referans amaçlı kullanılmaktadır.

PASSAT
B4
1994 - 1997

Resim	Ürün Kodu ve Açıklaması	Detay	OEM
	VW20063006 ROT TAKIMI ÖN AKS SAĞ RD088130	Ağırlık : 1,005 kg / 2.216 lb Rotbaşı : VW2006 Rotmili : VW3006	357422804
	VW20073005 ROT TAKIMI ÖN AKS SOL RD088127	Ağırlık : 0,988 kg / 2.178 lb Rotbaşı : VW2007 Rotmili : VW3005	357419803
	VW20073006 ROT TAKIMI ÖN AKS SOL RD088131	Ağırlık : 1,012 kg / 2.231 lb Rotbaşı : VW2007 Rotmili : VW3006	357422803
	VW4005 Z ROT ÖN SAĞ - SOL 19 MM RD0926	Ağırlık : 0,255 kg / 0.562 lb Malzeme Türü : 19 Mm Uzunluk : 80 mm / 3.15 inch Not : 23,5	357411315C*, 357411415K
	VW4006 Z ROT ÖN SAĞ - SOL 19,8 MM RD0927	Ağırlık : 0,256 kg / 0.564 lb Malzeme Türü : 19,8 Mm Uzunluk : 80 mm / 3.15 inch Aşık Dış Çapı : M10X1,5	357411315D*, 357411315D
	VW4007 Z ROT ÖN SAĞ - SOL METAL 23MM RD0940	Ağırlık : 0,239 kg / 0.527 lb Malzeme Türü : Metal 23Mm Uzunluk : 80 mm / 3.15 inch	357411315*, 357411315
	VW6008 SALINCAK ALT SAĞ RD1032	Ağırlık : 3,267 kg / 7.203 lb Malzeme Türü : Sac Metal	357407151
	VW6008J SALINCAK ÖN RD1109	Ağırlık : 2,802 kg / 6.177 lb Malzeme Türü : Sac Metal	357407151, 357407153
	VW6009 SALINCAK ALT SOL RD1028	Ağırlık : 3,76 kg / 8.289 lb Malzeme Türü : Sac Metal	357407151, 357407152
	AU11005 SALINCAK VE DENGE KOLU BURCU ÖN ORTA SOL VE SAĞ B40115	Şasi (Ön / Arka) : ÖN Yön : Orta Sol Ve Sağ Ağırlık : 0,111 kg / 0.245 lb Not : VW6014 - VW60614J	191407182, 357407182 357407182F
	VW11001 SALINCAK VE DENGE KOLU BURCU SOL VE SAĞ B40114	Yön : Sol Ve Sağ Ağırlık : 0.141 kg / 0.311 lb	191407181D, 191407181E 357407181

* Bu sayfada ve katalogdaki tüm araçların adları, markaları, modelleri, sembolleri, logoları, orijinal numaraları (oe) ve diğer üçüncü parti numaraları sadece referans amaçlı kullanılmaktadır.

PASSAT
B4
1994 - 1997

Resim	Ürün Kodu ve Açıklaması	Detay	OEM
	VW11036 SALINCAK VE DENGE KOLU BURCU SOL VE SAĞ	Yön : Sol Ve Sağ Ağırlık : 0.07 kg / 0.154 lb Not : BORUSU	191411315B, 4A0399413A
	VW11840 BURÇ	Yön : Sol Ve Sağ Ağırlık : 0,149 kg / 0.328 lb	357407181
	VW12130 Z-ROT BURCU ÖN	Şasi (Ön / Arka) : ÖN Ağırlık : 0.04 kg / 0.088 lb	357411315A*, 357411315D*
	VW12130K Z-ROT BURCU ÖN	Şasi (Ön / Arka) : ÖN Ağırlık : 0.08 kg / 0.176 lb	357411315A*, 357411315D*
	VW12011 BEŞİK (TRAVERS) BURCU SOL VE SAĞ	Yön : Sol Ve Sağ Ağırlık : 0.268 kg / 0.591 lb	333501541, 357501541 357501541A, 3A0501541
	VW12011K BEŞİK (TRAVERS) BURCU ARKA SOL VE SAĞ VW12011	Şasi (Ön / Arka) : ARKA Yön : Sol Ve Sağ Ağırlık : 0.536 kg / 1.182 lb	333501541, 357501541 357501541A, 3A0501541
	VW12001 AMORTİSÖR TAKOZU SOL VE SAĞ AMORTİSÖR TAKOZU	Yön : Sol Ve Sağ Ağırlık : 0.644 kg / 1.420 lb Not : AMORTİSÖR TAKOZU	176412329, 191412329 191412331
	VW12006 AMORTİSÖR TAKOZU SOL VE SAĞ AMORTİSÖR ÜST TAKOZU	Yön : Sol Ve Sağ Ağırlık : 0.445 kg / 0.981 lb Not : AMORTİSÖR ÜST TAKOZU	357412331A, 7201848 7M0412331, 95VW3K031AA
	VW12058 AMORTİSÖR TAKOZU SOL VE SAĞ	Yön : Sol Ve Sağ Ağırlık : 0.654 kg / 1.442 lb	357412329
	VW12007 MOTOR TAKOZU SAĞ MOTOR TAKOZU SAĞ	Yön : Sağ Ağırlık : 1,193 kg / 2.630 lb Not : MOTOR TAKOZU SAĞ	91199262A
	VW12008 MOTOR TAKOZU SOL VE SAĞ MOTOR TAKOZU	Yön : Sol Ve Sağ Ağırlık : 0.574 kg / 1.265 lb Not : MOTOR TAKOZU	357199381C, 357199402B 3A0199402

* Bu sayfada ve katalogdaki tüm araçların adları, markaları, modelleri, sembolleri, logoları, orijinal numaraları (oe) ve diğer üçüncü parti numaraları sadece referans amaçlı kullanılmaktadır.

PASSAT
B4
1994 - 1997



Resim	Ürün Kodu ve Açıklaması	Detay	OEM
	VW12074 MOTOR TAKOZU SOL VE SAĞ MOTOR TAKOZU	Yön : Sol Ve Sağ Ağırlık : 1.08 kg / 2.381 lb Not : MOTOR TAKOZU	1H0199609B, 1H0199609F 1H0199609G, 1H0199609J
	VW12092 MOTOR TAKOZU SAĞ MOTOR TAKOZU ARKA SAĞ	Yön : Sağ Ağırlık : 1,745 kg / 3.847 lb Not : MOTOR TAKOZU ARKA SAĞ	1H0199262B, 1H0199262G 1H0199262H
	VW12095 MOTOR TAKOZU SOL VE SAĞ MOTOR TAKOZU	Yön : Sol Ve Sağ Ağırlık : 1,389 kg / 3.062 lb Not : MOTOR TAKOZU	191199272, 191199272A 191199273, 191199279B 191199279C, 191199279D 357199279C
	VW12041 ŞANZIMAN TAKOZU SOL VE SAĞ ŞANZIMAN TAKOZU	Yön : Sol Ve Sağ Ağırlık : 0.307 kg / 0.677 lb Not : ŞANZIMAN TAKOZU	8D0399151J, 8D0399151P
	VW12089 SÜSPANSİYON TAKOZU SOL VE SAĞ SÜSPANSİYON TAKOZU	Yön : Sol Ve Sağ Ağırlık : 0.15 kg / 0.331 lb Not : SÜSPANSİYON TAKOZU	191412303A, 357412303E
	VW13008 DİREKSİYON KÖRÜĞÜ	Ağırlık : 0.225 kg / 0.496 lb	1H0422831B
	VW13010 DİREKSİYON KÖRÜĞÜ ÖN	Ağırlık : 0,124 kg / 0.273 lb	191422831
	OP14003 AKS KÖRÜĞÜ +KELEPÇE+YAĞ. AKS KÖRÜĞÜ DIŞ	Ağırlık : 0.2 kg / 0.441 lb	1603180
	RN14006 AKS KÖRÜĞÜ +KELEPÇE+YAĞ. DIŞ	Ağırlık : 0.2 kg / 0.441 lb	1603180, 1603204 16410170470106*, 16500170470106* 1H0498203, 271648 271649, 321498203A
	VW14008 AKS KÖRÜĞÜ +KELEPÇE+YAĞ. DIŞ		3B0407203A
	VW14013 AKS KÖRÜĞÜ +KELEPÇE+YAĞ. YAĞ+KELEPÇE	Ağırlık : 0.156 kg / 0.344 lb	113501149, 171407283A

* Bu sayfada ve katalogdaki tüm araçların adları, markaları, modelleri, sembolleri, logoları, orjinal numaraları (oe) ve diğer üçüncü parti numaraları sadece referans amaçlı kullanılmaktadır.

PASSAT
B4
1994 - 1997

Resim	Ürün Kodu ve Açıklaması	Detay	OEM
	VW14014 AKS KÖRÜĞÜ +KELEPÇE+YAĞ. YAĞ+KELEPÇE	Ağırlık : 0.28 kg / 0.617 lb	191498203C, 71498203

PASSAT
B5
1997 - 2005

Resim	Ürün Kodu ve Açıklaması	Detay	OEM
	AU2214 ROTBAŞI ÖN SAĞ - SOL RB2214	Ağırlık : 0,594 kg / 1.310 lb Uzunluk : 156 mm / 6.14 inch Gövde Diş Çapı : M14X1,5 Aşık Diş Çapı : M8X1,25 Aşık Konik Çapı : Ø17.5	4B0419811B, 4B0419811C 4B0419811E, 4B0419811F 4D0419811A, 4D0419811B 4D0419811G, 4D0419811H 4F0419811E, 4F0498811
	AU2214A ROTBAŞI SAĞ-SOL (KOMPLE DEMİR) RB2225	Ağırlık : 0,597 kg / 1.316 lb Uzunluk : 156 mm / 6.14 inch Gövde Diş Çapı : M14X1,5 Aşık Diş Çapı : M8X1,25 Aşık Konik Çapı : Ø17,4	4B0419811B, 4D0419811A 4D0419811J, 8E0419811B 8E0419811C
	AU3002 ROTMİLİ SAĞ-SOL 144 MM RB2814	Ağırlık : 0,445 kg / 0.981 lb Uzunluk : 130 mm / 5.12 inch Gövde Diş Çapı : M16X1,5 Aşık Diş Çapı : M14X1,5	4B0422821, 4D0422821 4D0422821A

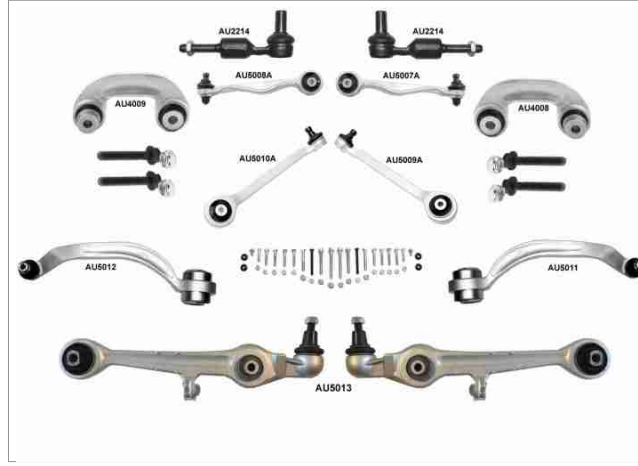
AU8001 / Süspansiyon Kit Ön
PASSAT
B5
1997 - 2005

OEM

8D0498998, 8D0498998-S1

Kit Parçaları











Resim	Ürün Kodu / Adı	OEM	OEM	Ürün Kodu / Adı	Resim
	AU2214 Rotbaşı Ön Sağ - Sol Rb2214	4B0419811B, 4B0419811C 4B0419811E, 4B0419811F 4D0419811A, 4D0419811B 4D0419811G, 4D0419811H 4F0419811E, 4F0498811	4B0419811B, 4B0419811C 4B0419811E, 4B0419811F 4D0419811A, 4D0419811B 4D0419811G, 4D0419811H 4F0419811E, 4F0498811	AU2214 Rotbaşı Ön Sağ - Sol Rb2214	
	AU4008 Z Rot Ön Sağ Alüminyum 90 Rb2921	8D0407318D, 8D0411318D	8D0407317D, 8D0411317D	AU4009 Z Rot Ön Sol Alüminyum 90 Rb2920	
	AU5007A Salıncak Ön Üst Sağ Rb2629	4D0407510B, 4D0407510D 4D0407510F, 4D0407510G 4D0407510H, 4D0407510J 4D0407510K, 8D0407510A 8D0407510C, 8D0407510E	4D0407509F, 4D0407509G 4D0407509J, 4D0407509K 8D0407509C, 8D0407509E 8E0407509A	AU5008A Salıncak Ön Üst Sol Rb2628	
	AU5009A Salıncak Ön Üst Sağ Rb2635	8D0407506A, 8D0407506B 8E0407506A, 8E0407506P	8D0407505A, 8E0407505A 8E0407505P	AU5010A Salıncak Ön Üst Sol Rb2634	
	AU5011 Salıncak Ön Alt Sağ Rb2637	4D0407694AC, 4D0407694AD 4D0407694E, 4D0407694H 4D0407694K, 4D0407694M 4D0407694N, 8E0407694 8E0407694AG, 8E0407694E	4D0407693AC, 4D0407693AD 4D0407693E, 4D0407693H 4D0407693K, 4D0407693M 4D0407693N, 8E0407693 8E0407693AG, 8E0407693E	AU5012 Salıncak Ön Alt Sol Rb2636	
	AU5013 Salıncak Ön Alt Ön Taraf Sol Ve Sağ Alüminyum Rb2616	4B3407151C, 4B3407151E 4D0407151G, 4D0407151H 4D0407151J	4B3407151C, 4B3407151E 4D0407151G, 4D0407151H 4D0407151J	AU5013 Salıncak Ön Alt Ön Taraf Sol Ve Sağ Alüminyum Rb2616	

PASSAT
B5
1997 - 2005

Resim	Ürün Kodu ve Açıklaması	Detay	OEM
	AU22143002 ROT TAKIMI ÖN AKS RB288115	Ağırlık : 1,043 kg / 2.299 lb Rotbaşı : AU2214 Rotmili : AU3002	1J0422812A, 4B0419801B 4B0419801E, 4B0419801M 4D0419801B, 4D0419801C 4D0419801D, 4D0419801L
	AU2214A3002 ROT TAKIMI ÖN AKS RB288136	Ağırlık : 1,026 kg / 2.262 lb Rotbaşı : AU2214 Rotmili : AU3002	4B0419801G, 4B0419801N 4D0419801Q, 8E0419801B
	AU4007 Z ROT ÖN SAĞ-SOL ALİMİNYUM 90 RB2942	Ağırlık : 0,378 kg / 0.833 lb Malzeme Türü : Alüminyum Uzunluk : 86 mm / 3.39 inch Aşık Diş Çapı : M10X1,5	4D0411317G, 4D0411317J 4D0411317K
	AU4008 Z ROT ÖN SAĞ ALİMİNYUM 90 RB2921	Ağırlık : 0,347 kg / 0.765 lb Malzeme Türü : Alüminyum Uzunluk : 90 mm / 3.54 inch	8D0407318D, 8D0411318D
	AU4009 Z ROT ÖN SOL ALİMİNYUM 90 RB2920	Ağırlık : 0,347 kg / 0.765 lb Malzeme Türü : Alüminyum Uzunluk : 90 mm / 3.54 inch	8D0407317D, 8D0411317D
	AU4010 Z ROT ÖN SAĞ-SOL ALİMİNYUM 90 RB2912	Ağırlık : 0,325 kg / 0.717 lb Malzeme Türü : Alüminyum Uzunluk : 90 mm / 3.54 inch	4D0411317J, 4D0411317K
	AU4017 Z ROT ARKA PLASTİK L=62,5	Ağırlık : 0,112 kg / 0.247 lb Uzunluk : 62,5 mm / 2.46 inch Not : PLASTİK	8E0505465D
	VW4015 Z ROT SOL VE SAĞ METAL RB2937	Ağırlık : 0,373 kg / 0.822 lb Malzeme Türü : Metal Uzunluk : 95,5 mm / 3.76 inch Aşık Diş Çapı : M10X1,5	1K0505465C, 1K0505465D 1K0505465H, 1K0505465J 1K0505465K
	VW4015K Z ROT SOL VE SAĞ METAL	Ağırlık : 0,373 kg / 0.822 lb Malzeme Türü : Metal Uzunluk : 95,5 mm / 3.76 inch Aşık Diş Çapı : M10X1,5	1K0505465C, 1K0505465D 1K0505465H, 1K0505465J 1K0505465K
	AU5007 SALINCAK ÖN ÜST SAĞ	Malzeme Türü : Alüminyum	4D0407510B, 4D0407510D
	AU5007A SALINCAK ÖN ÜST SAĞ RB2629	Ağırlık : 0,460 kg / 1.014 lb Malzeme Türü : Alüminyum	4D0407510B, 4D0407510D 4D0407510F, 4D0407510G 4D0407510H, 4D0407510J 4D0407510K, 8D0407510A 8D0407510C, 8D0407510E

* Bu sayfada ve katalogdaki tüm araçların adları, markaları, modelleri, sembolleri, logoları, orijinal numaraları (oe) ve diğer üçüncü parti numaraları sadece referans amaçlı kullanılmaktadır.

PASSAT
B5
1997 - 2005

Resim	Ürün Kodu ve Açıklaması	Detay	OEM
	AU5008 SALINCAK ÖN ÜST SOL	Malzeme Türü : Alüminyum	4D0407509B, 4D0407509D
	AU5008A SALINCAK ÖN ÜST SOL RB2628	Ağırlık : 0,460 kg / 1.014 lb Malzeme Türü : Alüminyum	4D0407509F, 4D0407509G 4D0407509J, 4D0407509K 8D0407509C, 8D0407509E 8E0407509A
	AU5009 SALINCAK ÖN ÜST SAĞ RB2630	Malzeme Türü : Alüminyum	8D0407506B, 8D0407506F 8D0407506H, 8D0407506K
	AU5009A SALINCAK ÖN ÜST SAĞ RB2635	Ağırlık : 0,488 kg / 1.076 lb Malzeme Türü : Alüminyum	8D0407506A, 8D0407506B 8E0407506A, 8E0407506P
	AU5010 SALINCAK ÖN ÜST SOL RB2631	Malzeme Türü : Alüminyum	8D0407505B, 8D0407505F 8D0407505H, 8D0407505K
	AU5010A SALINCAK ÖN ÜST SOL RB2634	Ağırlık : 0,488 kg / 1.076 lb Malzeme Türü : Alüminyum	8D0407505A, 8E0407505A 8E0407505P
	AU5011 SALINCAK ÖN ALT SAĞ RB2637	Ağırlık : 1,750 kg / 3.858 lb Malzeme Türü : Alüminyum	4D0407694AC, 4D0407694AD 4D0407694E, 4D0407694H 4D0407694K, 4D0407694M 4D0407694N, 8E0407694 8E0407694AG, 8E0407694E
	AU5012 SALINCAK ÖN ALT SOL RB2636	Ağırlık : 1,800 kg / 3.968 lb Malzeme Türü : Alüminyum	4D0407693AC, 4D0407693AD 4D0407693E, 4D0407693H 4D0407693K, 4D0407693M 4D0407693N, 8E0407693 8E0407693AG, 8E0407693E
	AU5013 SALINCAK ÖN ALT ÖN TARAF SOL VE SAĞ ALÜMİNYUM RB2616	Ağırlık : 1,520 kg / 3.351 lb Malzeme Türü : Alüminyum	4B3407151C, 4B3407151E 4D0407151G, 4D0407151H 4D0407151J
	AU5013A SALINCAK ÖN ALT ÖN TARAF SOL VE SAĞ ALÜMİNYUM RB2648	Ağırlık : 1,504 kg / 3.316 lb Malzeme Türü : Alüminyum	8E0407151E, 8E0407151K 8E0407151L, 8E0407151M 8E0407151N, 8E0407151R 8E0407151J
	AU5013B SALINCAK ÖN ALT ÖN TARAF SOL VE SAĞ ALÜMİNYUM RB2641	Ağırlık : 1,500 kg / 3.307 lb Malzeme Türü : Alüminyum	4B3407151C, 4B3407151K











* Bu sayfada ve katalogdaki tüm araçların adları, markaları, modelleri, sembolleri, logoları, orjinal numaraları (oe) ve diğer üçüncü parti numaraları sadece referans amaçlı kullanılmaktadır.

PASSAT
B5
1997 - 2005

Resim	Ürün Kodu ve Açıklaması	Detay	OEM
	AU5085 SALINCAK ÖN ÜST ÖNDEN SAĞ	Ağırlık : 0,515 kg / 1.135 lb Malzeme Türü : Alüminyum	8E0407506P
	AU5086 SALINCAK ÖN ÜST ÖNDEN SOL	Ağırlık : 0,515 kg / 1.135 lb Malzeme Türü : Alüminyum	8E0407505P
	AU5087 SALINCAK ÖN ÜST ARKADAN SAĞ	Ağırlık : 248,3 kg / 547.408 lb Malzeme Türü : Alüminyum	8E0407510P
	AU5088 SALINCAK ÖN ÜST ARKADAN SOL	Ağırlık : 248,3 kg / 547.408 lb Malzeme Türü : Alüminyum	8E0407509P
	AU11003 SALINCAK VE DENGE KOLU BURCU ÖN ÜST SOL VE SAĞ B22115	Şasi (Ön / Arka) : ÖN Yön : Üst Sol Ve Sağ Ağırlık : 0,075 kg / 0.165 lb	4B0407515, 4B0407515A 4D0407515C*, 4D0407515C
	AU11004 SALINCAK VE DENGE KOLU BURCU ÖN ORTA SOL VE SAĞ B22112	Şasi (Ön / Arka) : ÖN Yön : Orta Sol Ve Sağ Ağırlık : 0,112 kg / 0.247 lb	4D0407181F, 4D0407181H
	AU11006 SALINCAK VE DENGE KOLU BURCU ÖN SOL VE SAĞ	Şasi (Ön / Arka) : ÖN Yön : Sol Ve Sağ Ağırlık : 0,225 kg / 0.496 lb	4D0407182E, 4D0407182G 8E0407182A, 8E0407182E
	AU11007 SALINCAK VE DENGE KOLU BURCU ÖN ALT SOL VE SAĞ	Şasi (Ön / Arka) : ÖN Yön : Alt Sol Ve Sağ Ağırlık : 0,59 kg / 1.301 lb	4D0407183AB, 4D0407183AC 4D0407183D, 4D0407183M 4D0407183N, 4D0407183P 4D0407183S
	AU11033 SALINCAK VE DENGE KOLU BURCU ÖN ALT SOL VE SAĞ B22135	Şasi (Ön / Arka) : ÖN Yön : Alt Sol Ve Sağ Ağırlık : 0,072 kg / 0.159 lb	8E0407181B, 8E0407181C 8E0407181D
	VW11052 SALINCAK VE DENGE KOLU BURCU ALT SOL VE SAĞ B22130	Yön : Alt Sol Ve Sağ Ağırlık : 0,523 kg / 1.153 lb	4D0407183M, 4D0407183N 4D0407183P, 4D0407183Q 4E0407183M
	VW11180 Z-ROT BURCU ARKA	Şasi (Ön / Arka) : ARKA Ağırlık : 0.069 kg / 0.152 lb Uzunluk : VW4015 mm / 0.00 inch Aşık Dış Çapı : VW4015K	1K0505465C*, 1K0505465D* 1K0505465H*, 1K0505465J* 1K0505465K*

* Bu sayfada ve katalogdaki tüm araçların adları, markaları, modelleri, sembolleri, logoları, orjinal numaraları (oe) ve diğer üçüncü parti numaraları sadece referans amaçlı kullanılmaktadır.

PASSAT
B5
1997 - 2005

Resim	Ürün Kodu ve Açıklaması	Detay	OEM
	AU11091 ROTMİLİ BURCU VE LASTİĞİ		4B0419811E*, 4B0419811F* 4D0419811A*, 4D0419811B* 4F0419811B*, 4F0419811E* 4F0498811*, 8E0419811B*
	AU12029 ROTMİLİ BURCU VE LASTİĞİ ÖN	Şasi (Ön / Arka) : ÖN	171419804*, 171419804A* 175419804*
	AU12029K ROTMİLİ BURCU VE LASTİĞİ ÖN	Şasi (Ön / Arka) : ÖN	171419804*, 171419804A* 175419804*
	VW11053 TAŞIYICI DESTEK BURÇLARI SAĞ	Yön : Sağ Diğer Taraf : VW11054 Ağırlık : 1.49 kg / 3.285 lb	4B0501522D, 4B0501522E 8E0501522C, 8E0501522F 8E0501522J, 8E0501522L 8E0501522N
	VW11054 TAŞIYICI DESTEK BURÇLARI SOL	Yön : Sol Diğer Taraf : VW11053 Ağırlık : 1.49 kg / 3.285 lb	4B0501521D, 4B0501521E 8E0501521C, 8E0501521F 8E0501521J, 8E0501521L 8E0501521N
	AU12005 VİRAJ DEMİR LASTİĞİ SOL VE SAĞ RUBBER	Şasi (Ön / Arka) : ÖN Yön : Sol Ve Sağ Ağırlık : 0.06 kg / 0.132 lb Malzeme Türü : Rubber	4D0411327F, 4D0411327H
	AU12005K VİRAJ DEMİR LASTİĞİ SOL VE SAĞ RUBBER	Şasi (Ön / Arka) : ÖN Yön : Sol Ve Sağ Ağırlık : 0.12 kg / 0.265 lb Malzeme Türü : Rubber	4D0411327F, 4D0411327H
	SK12003 VİRAJ DEMİR LASTİĞİ SOL VE SAĞ RUBBER	Şasi (Ön / Arka) : ÖN Yön : Sol Ve Sağ Ağırlık : 0,075 kg / 0.165 lb Malzeme Türü : Rubber	1K0411303, 1K0411303AL* 1K0411303BK, 1K0411314 3C0411303AA*, 3C0411303T*
	SK12003K VİRAJ DEMİR LASTİĞİ SOL VE SAĞ RUBBER	Şasi (Ön / Arka) : ÖN Yön : Sol Ve Sağ Ağırlık : 0,150 kg / 0.331 lb Malzeme Türü : Rubber	1K0411303, 1K0411303AL* 1K0411303BK, 1K0411314 3C0411303AA*, 3C0411303T*
	VW12087 VİRAJ DEMİR LASTİĞİ SOL VE SAĞ RUBBER	Şasi (Ön / Arka) : ÖN Yön : Sol Ve Sağ Ağırlık : 0.059 kg / 0.130 lb Malzeme Türü : Rubber Not : VİRAJ LASTİĞİ	4D0411327E, 4D0411327G
	VW12087K VİRAJ DEMİR LASTİĞİ SOL VE SAĞ RUBBER	Şasi (Ön / Arka) : ÖN Yön : Sol Ve Sağ Ağırlık : 0.118 kg / 0.260 lb Malzeme Türü : Rubber	4D0411327E*, 4D0411327G*

* Bu sayfada ve katalogdaki tüm araçların adları, markaları, modelleri, sembolleri, logoları, orjinal numaraları (oe) ve diğer üçüncü parti numaraları sadece referans amaçlı kullanılmaktadır.

PASSAT
B5
1997 - 2005

Resim	Ürün Kodu ve Açıklaması	Detay	OEM
	SK12001 AMORTİSÖR TAKOZU ARKA SOL VE SAĞ	Şasi (Ön / Arka) : ARKA Yön : Sol Ve Sağ Ağırlık : 0.55 kg / 1.213 lb	3B0513353
	VW12022 AMORTİSÖR TAKOZU SOL VE SAĞ AMORTİSÖR TAKOZU	Yön : Sol Ve Sağ Ağırlık : 0.44 kg / 0.970 lb Not : AMORTİSÖR TAKOZU	4D0412377F
	AU12033 MOTOR TAKOZU ÖN	Şasi (Ön / Arka) : ÖN Ağırlık : 0,825 kg / 1.819 lb	4B0199379A, 4B0199379E
	VW12031 MOTOR TAKOZU SOL VE SAĞ MOTOR TAKOZU	Yön : Sol Ve Sağ Ağırlık : 0.831 kg / 1.832 lb Not : Motor takozu	8D0199379K
	VW12039 MOTOR TAKOZU SOL VE SAĞ MOTOR TAKOZU	Yön : Sol Ve Sağ Ağırlık : 0.816 kg / 1.799 lb Not : MOTOR TAKOZU	8D0199379C, 8D0199382AC 8D0199382AE, 8D0199382AP 8D0199382AR, 8D0199382C 8D0199382G, 8D0199382K 8D0199382M, 8D0199382S
	VW12071 MOTOR TAKOZU SOL VE SAĞ MOTOR TAKOZU	Yön : Sol Ve Sağ Ağırlık : 0.475 kg / 1.047 lb Not : MOTOR TAKOZU	8D0399151H
	AU12035 ŞANZIMAN TAKOZU	Ağırlık : 0,490 kg / 1.080 lb	4B0399151L, 4B0399151M 8E0399151D
	AU12006 SÜSPANSİYON TAKOZU ARKA SOL VE SAĞ	Şasi (Ön / Arka) : ARKA Yön : Sol Ve Sağ Ağırlık : 0.55 kg / 1.213 lb	1J0 512 131 B, 1J0 513 025 Q 1J0512131B, 1J0513025Q
	VW13001 DİREKSİYON KÖRÜĞÜ	Ağırlık : 0.065 kg / 0.143 lb	4D0419831
	VW13009 DİREKSİYON KÖRÜĞÜ	Ağırlık : 0.19 kg / 0.419 lb	8D0419831J, 8D0419831K
	VW14001 AKS KÖRÜĞÜ +KELEPÇE+YAĞ. DIŞ	Ağırlık : 0.14 kg / 0.309 lb	441 407 203A, 441407203A

* Bu sayfada ve katalogdaki tüm araçların adları, markaları, modelleri, sembolleri, logoları, orjinal numaraları (oe) ve diğer üçüncü parti numaraları sadece referans amaçlı kullanılmaktadır.

PASSAT
B5
1997 - 2005

Resim	Ürün Kodu ve Açıklaması	Detay	OEM
	VW14003 AKS KÖRÜĞÜ +KELEPÇE+YAĞ. DIŞ	Ağırlık : 0.25 kg / 0.551 lb	1K0 498 203, 1K0498203
	VW14008 AKS KÖRÜĞÜ +KELEPÇE+YAĞ. DIŞ		3B0407203A
	VW14012 AKS KÖRÜĞÜ +KELEPÇE+YAĞ. DIŞ	Ağırlık : 0.175 kg / 0.386 lb	3B0498203A, 4A0498203C 8D0498203A

PASSAT
B6
2005 - 2010

Resim	Ürün Kodu ve Açıklaması	Detay	OEM
	VW1019 ROTİL ÖN SAĞ Ø15,3 RB2538	Ağırlık : 0,555 kg / 1.224 lb Konik Ölçüsü : Ø15,3 Bağlantı Delik Çapı : Ø10,5 Aşık Diş Çapı : M12X1,5	3C0407366A
	VW1020 ROTİL ÖN SOL Ø15,3 RB2539	Ağırlık : 0,555 kg / 1.224 lb Konik Ölçüsü : Ø15,3 Bağlantı Delik Çapı : Ø10,5 Aşık Diş Çapı : M12X1,5	3C0407365A
	VW2008 ROTBAŞI ÖN SAĞ RD0342	Ağırlık : 0,412 kg / 0.908 lb Uzunluk : 95 mm / 3.74 inch Gövde Diş Çapı : M16X1,5 Aşık Diş Çapı : M12X1,5 Aşık Konik Çapı : Ø12,7	1K0423812A, 1K0423812C 1K0423812E, 1K0423812G 1K0423812J, 1K0423812K 1KD423812A
	VW2009 ROTBAŞI ÖN SOL RD0343	Ağırlık : 0,412 kg / 0.908 lb Uzunluk : 95 mm / 3.74 inch Gövde Diş Çapı : M16X1,5 Aşık Diş Çapı : M12X1,5 Aşık Konik Çapı : Ø13,5	1K0423811A, 1K0423811C 1K0423811E, 1K0423811G 1K0423811J, 1K0423811K 1KD423811A
	VW3009 ROTMİLİ SAĞ-SOL 310 RB2838	Ağırlık : 0,665 kg / 1.466 lb Uzunluk : 311 mm / 12.24 inch Gövde Diş Çapı : M16X1,5 Aşık Diş Çapı : M16X1,5	1K0423810A

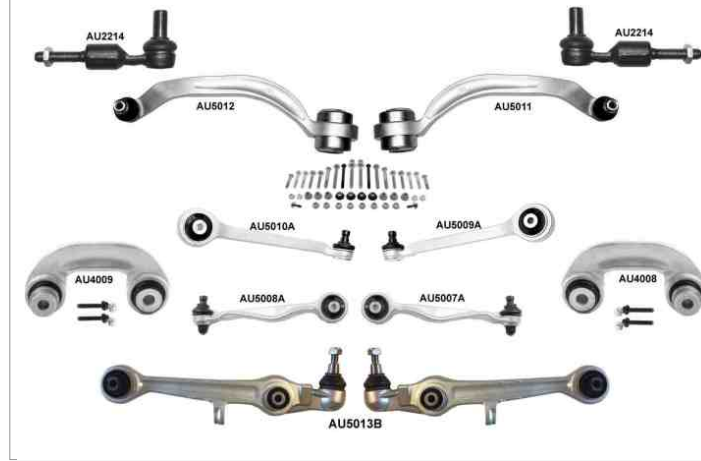
AU8002 / Süspansiyon Kit Ön
PASSAT
B6
2005 - 2010

OEM

4B3498998, 4B3498998-S1, 8B0498998S1

Kit Parçaları











Resim	Ürün Kodu / Adı	OEM	OEM	Ürün Kodu / Adı	Resim
	AU2214 Rotbaşı Ön Sağ - Sol Rb2214	4B0419811B, 4B0419811C 4B0419811E, 4B0419811F 4D0419811A, 4D0419811B 4D0419811G, 4D0419811H 4F0419811E, 4F0498811	4B0419811B, 4B0419811C 4B0419811E, 4B0419811F 4D0419811A, 4D0419811B 4D0419811G, 4D0419811H 4F0419811E, 4F0498811	AU2214 Rotbaşı Ön Sağ - Sol Rb2214	
	AU4008 Z Rot Ön Sağ Alüminyum 90 Rb2921	8D0407318D, 8D0411318D	8D0407317D, 8D0411317D	AU4009 Z Rot Ön Sol Alüminyum 90 Rb2920	
	AU5007A Salıncak Ön Üst Sağ Rb2629	4D0407510B, 4D0407510D 4D0407510F, 4D0407510G 4D0407510H, 4D0407510J 4D0407510K, 8D0407510A 8D0407510C, 8D0407510E	4D0407509F, 4D0407509G 4D0407509J, 4D0407509K 8D0407509C, 8D0407509E 8E0407509A	AU5008A Salıncak Ön Üst Sol Rb2628	
	AU5009A Salıncak Ön Üst Sağ Rb2635	8D0407506A, 8D0407506B 8E0407506A, 8E0407506P	8D0407505A, 8E0407505A 8E0407505P	AU5010A Salıncak Ön Üst Sol Rb2634	
	AU5011 Salıncak Ön Alt Sağ Rb2637	4D0407694AC, 4D0407694AD 4D0407694E, 4D0407694H 4D0407694K, 4D0407694M 4D0407694N, 8E0407694 8E0407694AG, 8E0407694E	4D0407693AC, 4D0407693AD 4D0407693E, 4D0407693H 4D0407693K, 4D0407693M 4D0407693N, 8E0407693 8E0407693AG, 8E0407693E	AU5012 Salıncak Ön Alt Sol Rb2636	
	AU5013B Salıncak Ön Alt Ön Taraf Sol Ve Sağ Alüminyum Rb2641	4B3407151C, 4B3407151K	4B3407151C, 4B3407151K	AU5013B Salıncak Ön Alt Ön Taraf Sol Ve Sağ Alüminyum Rb2641	

VW8002 / Süspansiyon Kit Ön
PASSAT
B6
2005 - 2010

Kit Parçaları

Resim	Ürün Kodu / Adı	OEM	OEM	Ürün Kodu / Adı	Resim
	VW2008 Rotbaşı Ön Sağ Rd0342	1K0423812A, 1K0423812C 1K0423812E, 1K0423812G 1K0423812J, 1K0423812K 1KD423812A	1K0423811A, 1K0423811C 1K0423811E, 1K0423811G 1K0423811J, 1K0423811K 1KD423811A	VW2009 Rotbaşı Ön Sol Rd0343	
	VW3009 Rotmili Sağ-sol 310 Rb2838	1K0423810A	1K0411315B, 1K0411315D 1K0411315J, 1K0411315K 1K0411315R, 5Q0411315A 5Q0411315B	VW4014 Z Rot Ön Sağ-sol Metal 335 Rb2935	
	VW6032 Salıncak Ön Sağ Rd1051	3C0407151A, 3C0407151B 3C0407151E, 3C0407151G*	3C0407151A, 3C0407151B 3C0407151E, 3C0407151H*	VW6033 Salıncak Ön Sol Rd1052	

PASSAT
B6
2005 - 2010

Resim	Ürün Kodu ve Açıklaması	Detay	OEM
	VW20083009 ROT TAKIMI ÖN AKS SAĞ RB288137	Ağırlık : 1,078 kg / 2.377 lb Rotbaşı : VW2008 Rotmili : VW3009	
	VW20093009 ROT TAKIMI ÖN SOL RB288138	Ağırlık : 1,077 kg / 2.374 lb Rotbaşı : VW2009 Rotmili : VW3009	
	SK4005 Z ROT ÖM SAĞ-SOL L=335MM	Ağırlık : 0,322 kg / 0.710 lb Malzeme Türü : Metal Uzunluk : 335 mm / 13.19 inch Aşık Diş Çapı : M12X1,5	5Q0411315B
	VW4014 Z ROT ÖN SAĞ-SOL METAL 335 RB2935	Ağırlık : 0,46 kg / 1.014 lb Malzeme Türü : Metal Uzunluk : 335 mm / 13.19 inch Aşık Diş Çapı : M12X1,5	1K0411315B, 1K0411315D 1K0411315J, 1K0411315K 1K0411315R, 5Q0411315A 5Q0411315B
	VW4015 Z ROT SOL VE SAĞ METAL RB2937	Ağırlık : 0,373 kg / 0.822 lb Malzeme Türü : Metal Uzunluk : 95,5 mm / 3.76 inch Aşık Diş Çapı : M10X1,5	1K0505465C, 1K0505465D 1K0505465H, 1K0505465J 1K0505465K
	VW4015K Z ROT SOL VE SAĞ METAL	Ağırlık : 0,373 kg / 0.822 lb Malzeme Türü : Metal Uzunluk : 95,5 mm / 3.76 inch Aşık Diş Çapı : M10X1,5	1K0505465C, 1K0505465D 1K0505465H, 1K0505465J 1K0505465K
	AU6010 SALINCAK ÜST SOL VE SAĞ RA5155	Ağırlık : 1,298 kg / 2.862 lb Malzeme Türü : Sac Metal	1K0505323H, 1K0505323N
	AU9037 SALINCAK ARKA ALT SAĞ SAC LEVHA	Ağırlık : 1,735 kg / 3.825 lb Malzeme Türü : Sac Metal	3C0505224E
	AU9038 SALINCAK VE DENGE KOLU ARKA ALT SOL SAC LEVHA	Ağırlık : 1,735 kg / 3.825 lb Malzeme Türü : Sac Metal	3C0505223E
	VW6032 SALINCAK ÖN SAĞ RD1051	Ağırlık : 3,441 kg / 7.586 lb Malzeme Türü : Alüminyum	3C0407151A, 3C0407151B 3C0407151E, 3C0407151G*
	VW6032J SALINCAK ÖN RD1050	Ağırlık : 2,9 kg / 6.393 lb Malzeme Türü : Alüminyum	3C0407151A, 3C0407151B 3C0407151E, 3C0407151G 3C0407151H

* Bu sayfada ve katalogdaki tüm araçların adları, markaları, modelleri, sembolleri, logoları, orjinal numaraları (oe) ve diğer üçüncü parti numaraları sadece referans amaçlı kullanılmaktadır.

PASSAT
B6
2005 - 2010

Resim	Ürün Kodu ve Açıklaması	Detay	OEM
	VW6033 SALINCAK ÖN SOL RD1052	Ağırlık : 3,441 kg / 7.586 lb Malzeme Türü : Alüminyum	3C0407151A, 3C0407151B 3C0407151E, 3C0407151H*
	VW6059 SALINCAK ÖN ALT SAĞ	Ağırlık : 3,490 kg / 7.694 lb Malzeme Türü : Alüminyum	3C0407152A, 3C0407152B 3C0407152E
	VW6060 SALINCAK ALT SOL	Ağırlık : 3,490 kg / 7.694 lb Malzeme Türü : Alüminyum	3C0407151A, 3C0407151B 3C0407151E
	VW9001 SALINCAK ARKA	Ağırlık : 2,55 kg / 5.622 lb Malzeme Türü : Sac Metal	1K0505311AA, 1K0505311ABÂ 1K0505311H, 1K0505311S 1K0505311T
	AU11035 SALINCAK VE DENGE KOLU BURCU ARKA SOL VE SAĞ	Şasi (Ön / Arka) : ARKA Yön : Sol Ve Sağ Ağırlık : 0,25 kg / 0.551 lb	1K0505171C
	AU11052 SALINCAK VE DENGE KOLU BURCU SOL VE SAĞ	Yön : Sol Ve Sağ Ağırlık : 0,178 kg / 0.392 lb	1K0505541B, 1K0505541C 1K0505541D
	AU11088 SALINCAK VE DENGE KOLU BURCU ARKA	Şasi (Ön / Arka) : ARKA Ağırlık : 0,165 kg / 0.364 lb	1K0505541C, 1K0505541D 3C0505541
	VW11037 SALINCAK VE DENGE KOLU BURCU SOL VE SAĞ	Yön : Sol Ve Sağ Ağırlık : 0.11 kg / 0.243 lb	1K0505279A
	VW11042 SALINCAK VE DENGE KOLU BURCU ORTA SOL VE SAĞ	Yön : Orta Sol Ve Sağ Ağırlık : 0,182 kg / 0.401 lb	1K0407182, 5Q0407182
	VW11046 SALINCAK VE DENGE KOLU BURCU SAĞ B40133	Yön : Sağ Ağırlık : 0,6 kg / 1.323 lb	3C0199231A, 3C0199231B 3C0199231D
	VW11046B SALINCAK VE DENGE KOLU BURCU SAĞ	Yön : Sağ Ağırlık : 0.445 kg / 0.981 lb Not : BURÇ GÖVDESİ	3C0199231A, 3C0199231B 3C0199231D

* Bu sayfada ve katalogdaki tüm araçların adları, markaları, modelleri, sembolleri, logoları, orjinal numaraları (oe) ve diğer üçüncü parti numaraları sadece referans amaçlı kullanılmaktadır.

PASSAT
B6
2005 - 2010

Resim	Ürün Kodu ve Açıklaması	Detay	OEM
	VW11051 SALINCAK VE DENGE KOLU BURCU SOL VE SAĞ	Yön : Sol Ve Sağ Ağırlık : 0.121 kg / 0.267 lb	6Q0407183, 6Q0407183A
	VW11056 SALINCAK VE DENGE KOLU BURCU ARKA SOL VE SAĞ	Şasi (Ön / Arka) : ARKA Yön : Sol Ve Sağ Ağırlık : 0.13 kg / 0.287 lb	1K0505203A, 1K0505323D 1K0505323G, 1K0505323H 1K0505323N, 5Q0505323C
	VW11180 Z-ROT BURCU ARKA	Şasi (Ön / Arka) : ARKA Ağırlık : 0.069 kg / 0.152 lb Uzunluk : VW4015 mm / 0.00 inch Aşık Diş Çapı : VW4015K	1K0505465C*, 1K0505465D* 1K0505465H*, 1K0505465J* 1K0505465K*
	VW12159 TAŞIYICI DESTEK BURÇLARI ARKA SOL VE SAĞ	Şasi (Ön / Arka) : ARKA Yön : Sol Ve Sağ Ağırlık : 0,130 kg / 0.287 lb	1K0505553, 1K0505553A
	AU12024 TORSİYON BURCU ARKA SOL VE SAĞ	Şasi (Ön / Arka) : ARKA Yön : Sol Ve Sağ Ağırlık : 0.557 kg / 1.228 lb	1K0505145F, 1K0505145H 1K0505145K
	VW12127 TORSİYON BURCU ARKA	Şasi (Ön / Arka) : ARKA Ağırlık : 0,265 kg / 0.584 lb	3C0505145
	VW12128 TORSİYON BURCU ARKA	Şasi (Ön / Arka) : ARKA Ağırlık : 0,200 kg / 0.441 lb	3C0505145A
	SK12003 VİRAJ DEMİR LASTİĞİ SOL VE SAĞ RUBBER	Şasi (Ön / Arka) : ÖN Yön : Sol Ve Sağ Ağırlık : 0,075 kg / 0.165 lb Malzeme Türü : Rubber	1K0411303, 1K0411303AL* 1K0411303BK, 1K0411314 3C0411303AA*, 3C0411303T*
	SK12003K VİRAJ DEMİR LASTİĞİ SOL VE SAĞ RUBBER	Şasi (Ön / Arka) : ÖN Yön : Sol Ve Sağ Ağırlık : 0,150 kg / 0.331 lb Malzeme Türü : Rubber	1K0411303, 1K0411303AL* 1K0411303BK, 1K0411314 3C0411303AA*, 3C0411303T*
	VW12017 AMORTİSÖR TAKOZU SOL VE SAĞ AMORTİSÖR TAKOZU	Yön : Sol Ve Sağ Ağırlık : 0.847 kg / 1.867 lb Not : AMORTİSÖR TAKOZU	1K0412331B, 1K0412331C
	VW12109 AMORTİSÖR TAKOZU SOL VE SAĞ AMORTİSÖR RULMANI	Yön : Sol Ve Sağ Ağırlık : 0.26 kg / 0.573 lb Not : AMORTİSÖR RULMANI	6N0412249C, 6N0412249E







* Bu sayfada ve katalogdaki tüm araçların adları, markaları, modelleri, sembolleri, logoları, orjinal numaraları (oe) ve diğer üçüncü parti numaraları sadece referans amaçlı kullanılmaktadır.

PASSAT
B6
2005 - 2010





Resim	Ürün Kodu ve Açıklaması	Detay	OEM
	VW12109K AMORTİSÖR TAKOZU SOL VE SAĞ 2 PCS	Yön : Sol Ve Sağ Ağırlık : 0.52 kg / 1.146 lb Not : 2 PCS	6N0412249C, 6N0412249E
	VW12029 MOTOR TAKOZU SOL VE SAĞ MOTOR TAKOZU	Yön : Sol Ve Sağ Ağırlık : 0.585 kg / 1.290 lb Not : Motor takozu	1K0199855AD, 1K0199855BA 1K0199855K
	VW12032 MOTOR TAKOZU SOL VE SAĞ MOTOR TAKOZU	Yön : Sol Ve Sağ Ağırlık : 0.64 kg / 1.411 lb Not : Motor takozu	1K0199855BB, 1K0199855L
	VW12073 MOTOR TAKOZU SOL VE SAĞ MOTOR TAKOZU	Yön : Sol Ve Sağ Ağırlık : 1.643 kg / 3.622 lb Not : MOTOR TAKOZU	1K0199262AC, 1K0199262AL 1K0199262L
	VW12077 MOTOR TAKOZU SOL VE SAĞ MOTOR TAKOZU	Yön : Sol Ve Sağ Ağırlık : 1.95 kg / 4.299 lb Not : MOTOR TAKOZU	1K0199262CG, 1K0199262CP
	VW12082 MOTOR TAKOZU SOL VE SAĞ MOTOR TAKOZU	Yön : Sol Ve Sağ Ağırlık : 2.05 kg / 4.519 lb Not : MOTOR TAKOZU	1K0199262AK, 1K0199262K
	VW12097 MOTOR TAKOZU SOL VE SAĞ MOTOR TAKOZU	Yön : Sol Ve Sağ Ağırlık : 0.251 kg / 0.553 lb Not : MOTOR TAKOZU	1K0199868, 1K0199868A 1K0199868C, 1K0199868P 1K0199868Q
	VW12108 MOTOR TAKOZU SOL VE SAĞ MOTOR TAKOZU	Yön : Sol Ve Sağ Ağırlık : 2.1 kg / 4.630 lb Not : MOTOR TAKOZU	1K0199262P
	VW12110 MOTOR TAKOZU SOL VE SAĞ MOTOR TAKOZU	Yön : Sol Ve Sağ Ağırlık : 1.918 kg / 4.228 lb Not : MOTOR TAKOZU	1K0199262AB, 1K0199262AM 1K0199262M
	VW12038 SÜSPANSİYON TAKOZU SOL VE SAĞ SUS. ARA YATAK TAKOZ ARKA	Yön : Sol Ve Sağ Ağırlık : 0.12 kg / 0.265 lb Not : SUS. ARA YATAK TAKOZ ARKA	3C0 511 359, 3C0511359
	VW12051 SÜSPANSİYON TAKOZU SOL VE SAĞ LASTİK DAYANAK SÜSPANSİYON	Yön : Sol Ve Sağ Ağırlık : 0.045 kg / 0.099 lb Not : LASTİK DAYANAK SÜSPANSİYON	1K0412303B

* Bu sayfada ve katalogdaki tüm araçların adları, markaları, modelleri, sembolleri, logoları, orjinal numaraları (oe) ve diğer üçüncü parti numaraları sadece referans amaçlı kullanılmaktadır.

PASSAT
B6
2005 - 2010

Resim	Ürün Kodu ve Açıklaması	Detay	OEM
	VW12086 RADYATÖR TAKOZU SOL VE SAĞ RADYATÖR ÜST LASTİĞİ	Yön : Sol Ve Sağ Ağırlık : 0.024 kg / 0.053 lb Not : RADYATÖR ÜST LASTİĞİ	1K0121367F
	VW13006 DİREKSİYON KÖRÜĞÜ	Ağırlık : 0.145 kg / 0.320 lb	1K0423831A, 5C0423831
	VW13006K DİREKSİYON KÖRÜĞÜ SOL VE SAĞ 2 PİECES	Ağırlık : 0.29 kg / 0.639 lb	1K0423831A, 5C0423831
	VW14003 AKS KÖRÜĞÜ +KELEPÇE+YAĞ. DIŞ	Ağırlık : 0.25 kg / 0.551 lb	1K0 498 203, 1K0498203
	VW14011 AKS KÖRÜĞÜ +KELEPÇE+YAĞ. İÇ	Ağırlık : 0.236 kg / 0.520 lb	1K0498201D
	AU15001 AMORTİSÖR KÖRÜĞÜ ÖN	Şasi (Ön / Arka) : ÖN Ağırlık : 0,110 kg / 0.243 lb	6N0413175A

PASSAT
B7
2010 - 2014

Resim	Ürün Kodu ve Açıklaması	Detay	OEM
	VW1019 ROTİL ÖN SAĞ Ø15,3 RB2538	Ağırlık : 0,555 kg / 1.224 lb Konik Ölçüsü : Ø15,3 Bağlantı Delik Çapı : Ø10,5 Aşık Diş Çapı : M12X1,5	3C0407366A
	VW1020 ROTİL ÖN SOL Ø15,3 RB2539	Ağırlık : 0,555 kg / 1.224 lb Konik Ölçüsü : Ø15,3 Bağlantı Delik Çapı : Ø10,5 Aşık Diş Çapı : M12X1,5	3C0407365A
	VW2008 ROTBAŞI ÖN SAĞ RD0342	Ağırlık : 0,412 kg / 0.908 lb Uzunluk : 95 mm / 3.74 inch Gövde Diş Çapı : M16X1,5 Aşık Diş Çapı : M12X1,5 Aşık Konik Çapı : Ø12,7	1K0423812A, 1K0423812C 1K0423812E, 1K0423812G 1K0423812J, 1K0423812K 1KD423812A
	VW2009 ROTBAŞI ÖN SOL RD0343	Ağırlık : 0,412 kg / 0.908 lb Uzunluk : 95 mm / 3.74 inch Gövde Diş Çapı : M16X1,5 Aşık Diş Çapı : M12X1,5 Aşık Konik Çapı : Ø13,5	1K0423811A, 1K0423811C 1K0423811E, 1K0423811G 1K0423811J, 1K0423811K 1KD423811A

* Bu sayfada ve katalogdaki tüm araçların adları, markaları, modelleri, sembolleri, logoları, orjinal numaraları (oe) ve diğer üçüncü parti numaraları sadece referans amaçlı kullanılmaktadır.

PASSAT**B7****2010 - 2014**

Resim	Ürün Kodu ve Açıklaması	Detay	OEM
	VW3009 ROTMİLİ SAĞ-SOL 310 RB2838	Ağırlık : 0,665 kg / 1.466 lb Uzunluk : 311 mm / 12.24 inch Gövde Diş Çapı : M16X1,5 Aşık Diş Çapı : M16X1,5	1K0423810A

VW8002 / Süspansiyon Kit Ön

PASSAT

B7

2010 - 2014













Kit Parçaları

Resim	Ürün Kodu / Adı	OEM	OEM	Ürün Kodu / Adı	Resim
	VW2008 Rotbaşı Ön Sağ Rd0342	1K0423812A, 1K0423812C 1K0423812E, 1K0423812G 1K0423812J, 1K0423812K 1KD423812A	1K0423811A, 1K0423811C 1K0423811E, 1K0423811G 1K0423811J, 1K0423811K 1KD423811A	VW2009 Rotbaşı Ön Sol Rd0343	
	VW3009 Rotmili Sağ-sol 310 Rb2838	1K0423810A	1K0411315B, 1K0411315D 1K0411315J, 1K0411315K 1K0411315R, 5Q0411315A 5Q0411315B	VW4014 Z Rot Ön Sağ-sol Metal 335 Rb2935	
	VW6032 Salıncak Ön Sağ Rd1051	3C0407151A, 3C0407151B 3C0407151E, 3C0407151G*	3C0407151A, 3C0407151B 3C0407151E, 3C0407151H*	VW6033 Salıncak Ön Sol Rd1052	











* Bu sayfada ve katalogdaki tüm araçların adları, markaları, modelleri, sembolleri, logoları, orjinal numaraları (oe) ve diğer üçüncü parti numaraları sadece referans amaçlı kullanılmaktadır.

PASSAT
B7
2010 - 2014

Resim	Ürün Kodu ve Açıklaması	Detay	OEM
	VW20083009 ROT TAKIMI ÖN AKS SAĞ RB288137	Ağırlık : 1,078 kg / 2.377 lb Rotbaşı : VW2008 Rotmili : VW3009	
	VW20093009 ROT TAKIMI ÖN SOL RB288138	Ağırlık : 1,077 kg / 2.374 lb Rotbaşı : VW2009 Rotmili : VW3009	
	SK4005 Z ROT ÖM SAĞ-SOL L=335MM	Ağırlık : 0,322 kg / 0.710 lb Malzeme Türü : Metal Uzunluk : 335 mm / 13.19 inch Aşık Diş Çapı : M12X1,5	5Q0411315B
	VW4014 Z ROT ÖN SAĞ-SOL METAL 335 RB2935	Ağırlık : 0,46 kg / 1.014 lb Malzeme Türü : Metal Uzunluk : 335 mm / 13.19 inch Aşık Diş Çapı : M12X1,5	1K0411315B, 1K0411315D 1K0411315J, 1K0411315K 1K0411315R, 5Q0411315A 5Q0411315B
	VW4015 Z ROT SOL VE SAĞ METAL RB2937	Ağırlık : 0,373 kg / 0.822 lb Malzeme Türü : Metal Uzunluk : 95,5 mm / 3.76 inch Aşık Diş Çapı : M10X1,5	1K0505465C, 1K0505465D 1K0505465H, 1K0505465J 1K0505465K
	VW4015K Z ROT SOL VE SAĞ METAL	Ağırlık : 0,373 kg / 0.822 lb Malzeme Türü : Metal Uzunluk : 95,5 mm / 3.76 inch Aşık Diş Çapı : M10X1,5	1K0505465C, 1K0505465D 1K0505465H, 1K0505465J 1K0505465K
	AU9037 SALINCAK ARKA ALT SAĞ SAC LEVHA	Ağırlık : 1,735 kg / 3.825 lb Malzeme Türü : Sac Metal	3C0505224E
	AU9038 SALINCAK VE DENG KOLU ARKA ALT SOL SAC LEVHA	Ağırlık : 1,735 kg / 3.825 lb Malzeme Türü : Sac Metal	3C0505223E
	SK9001 SALINCAK ARKA ALT	Ağırlık : 0,701 kg / 1.545 lb Malzeme Türü : Sac Metal	1K0501529J
	VW6032 SALINCAK ÖN SAĞ RD1051	Ağırlık : 3,441 kg / 7.586 lb Malzeme Türü : Alüminyum	3C0407151A, 3C0407151B 3C0407151E, 3C0407151G*
	VW6032J SALINCAK ÖN RD1050	Ağırlık : 2,9 kg / 6.393 lb Malzeme Türü : Alüminyum	3C0407151A, 3C0407151B 3C0407151E, 3C0407151G 3C0407151H











* Bu sayfada ve katalogdaki tüm araçların adları, markaları, modelleri, sembolleri, logoları, orjinal numaraları (oe) ve diğer üçüncü parti numaraları sadece referans amaçlı kullanılmaktadır.

PASSAT
B7
2010 - 2014

Resim	Ürün Kodu ve Açıklaması	Detay	OEM
	VW6033 SALINCAK ÖN SOL RD1052	Ağırlık : 3,441 kg / 7.586 lb Malzeme Türü : Alüminyum	3C0407151A, 3C0407151B 3C0407151E, 3C0407151H*
	VW6051 SALINCAK ÖN SAĞ	Ağırlık : 4,34 kg / 9.568 lb Malzeme Türü : Sac Metal	5N0407152*
	VW6051J SALINCAK ÖN SAĞ	Ağırlık : 3,79 kg / 8.356 lb Malzeme Türü : Sac Metal	5N0407152
	VW6052 SALINCAK ÖN SOL	Ağırlık : 4,34 kg / 9.568 lb Malzeme Türü : Sac Metal	5N0407151*
	VW6052J SALINCAK ÖN SOL	Ağırlık : 3,79 kg / 8.356 lb Malzeme Türü : Sac Metal	5N0407151
	VW6059 SALINCAK ÖN ALT SAĞ	Ağırlık : 3,490 kg / 7.694 lb Malzeme Türü : Alüminyum	3C0407152A, 3C0407152B 3C0407152E
	VW6060 SALINCAK ALT SOL	Ağırlık : 3,490 kg / 7.694 lb Malzeme Türü : Alüminyum	3C0407151A, 3C0407151B 3C0407151E
	VW9001 SALINCAK ARKA	Ağırlık : 2,55 kg / 5.622 lb Malzeme Türü : Sac Metal	1K0505311AA, 1K0505311ABÂ 1K0505311H, 1K0505311S 1K0505311T
	AU11035 SALINCAK VE DENGE KOLU BURCU ARKA SOL VE SAĞ	Şasi (Ön / Arka) : ARKA Yön : Sol Ve Sağ Ağırlık : 0,25 kg / 0.551 lb	1K0505171C
	AU11088 SALINCAK VE DENGE KOLU BURCU ARKA	Şasi (Ön / Arka) : ARKA Ağırlık : 0,165 kg / 0.364 lb	1K0505541C, 1K0505541D 3C0505541
	SK11009 SALINCAK VE DENGE KOLU BURCU ARKA SOL VE SAĞ	Şasi (Ön / Arka) : ARKA Yön : Sol Ve Sağ Ağırlık : 0,176 kg / 0.388 lb	1K0501529J*

* Bu sayfada ve katalogdaki tüm araçların adları, markaları, modelleri, sembolleri, logoları, orjinal numaraları (oe) ve diğer üçüncü parti numaraları sadece referans amaçlı kullanılmaktadır.

PASSAT
B7
2010 - 2014

Resim	Ürün Kodu ve Açıklaması	Detay	OEM
	SK11010 SALINCAK VE DENGE KOLU BURCU ARKA SOL VE SAĞ	Şasi (Ön / Arka) : ARKA Yön : Sol Ve Sağ Ağırlık : 0,196 kg / 0.432 lb Not : BÜYÜK	1K0501529J*
	VW11037 SALINCAK VE DENGE KOLU BURCU SOL VE SAĞ	Yön : Sol Ve Sağ Ağırlık : 0.11 kg / 0.243 lb	1K0505279A
	VW11042 SALINCAK VE DENGE KOLU BURCU ORTA SOL VE SAĞ	Yön : Orta Sol Ve Sağ Ağırlık : 0,182 kg / 0.401 lb	1K0407182, 5Q0407182
	VW11046 SALINCAK VE DENGE KOLU BURCU SAĞ B40133	Yön : Sağ Ağırlık : 0,6 kg / 1.323 lb	3C0199231A, 3C0199231B 3C0199231D
	VW11046B SALINCAK VE DENGE KOLU BURCU SAĞ	Yön : Sağ Ağırlık : 0.445 kg / 0.981 lb Not : BURÇ GÖVDESİ	3C0199231A, 3C0199231B 3C0199231D
	VW11051 SALINCAK VE DENGE KOLU BURCU SOL VE SAĞ	Yön : Sol Ve Sağ Ağırlık : 0.121 kg / 0.267 lb	6Q0407183, 6Q0407183A
	VW11180 Z-ROT BURCU ARKA	Şasi (Ön / Arka) : ARKA Ağırlık : 0.069 kg / 0.152 lb Uzunluk : VW4015 mm / 0.00 inch Aşık Diş Çapı : VW4015K	1K0505465C*, 1K0505465D* 1K0505465H*, 1K0505465J* 1K0505465K*
	VW12159 TAŞIYICI DESTEK BURÇLARI ARKA SOL VE SAĞ	Şasi (Ön / Arka) : ARKA Yön : Sol Ve Sağ Ağırlık : 0,130 kg / 0.287 lb	1K0505553, 1K0505553A
	AU12024 TORSİYON BURCU ARKA SOL VE SAĞ	Şasi (Ön / Arka) : ARKA Yön : Sol Ve Sağ Ağırlık : 0.557 kg / 1.228 lb	1K0505145F, 1K0505145H 1K0505145K
	VW12127 TORSİYON BURCU ARKA	Şasi (Ön / Arka) : ARKA Ağırlık : 0,265 kg / 0.584 lb	3C0505145
	VW12128 TORSİYON BURCU ARKA	Şasi (Ön / Arka) : ARKA Ağırlık : 0,200 kg / 0.441 lb	3C0505145A





* Bu sayfada ve katalogdaki tüm araçların adları, markaları, modelleri, sembolleri, logoları, orjinal numaraları (oe) ve diğer üçüncü parti numaraları sadece referans amaçlı kullanılmaktadır.

PASSAT
B7
2010 - 2014

Resim	Ürün Kodu ve Açıklaması	Detay	OEM
	VW12017 AMORTİSÖR TAKOZU SOL VE SAĞ AMORTİSÖR TAKOZU	Yön : Sol Ve Sağ Ağırlık : 0.847 kg / 1.867 lb Not : AMORTİSÖR TAKOZU	1K0412331B, 1K0412331C
	VW12109 AMORTİSÖR TAKOZU SOL VE SAĞ AMORTİSÖR RULMANI	Yön : Sol Ve Sağ Ağırlık : 0.26 kg / 0.573 lb Not : AMORTİSÖR RULMANI	6N0412249C, 6N0412249E
	VW12109K AMORTİSÖR TAKOZU SOL VE SAĞ 2 PCS	Yön : Sol Ve Sağ Ağırlık : 0.52 kg / 1.146 lb Not : 2 PCS	6N0412249C, 6N0412249E
	VW12027 MOTOR TAKOZU SOL VE SAĞ MOTOR KULAĞI	Yön : Sol Ve Sağ Ağırlık : 2.02 kg / 4.453 lb Not : MOTOR KULAĞI	1K0199262, 1K0199262CN
	VW12038 SÜSPANSİYON TAKOZU SOL VE SAĞ SUS. ARA YATAK TAKOZ ARKA	Yön : Sol Ve Sağ Ağırlık : 0.12 kg / 0.265 lb Not : SUS. ARA YATAK TAKOZ ARKA	3C0 511 359, 3C0511359
	VW12051 SÜSPANSİYON TAKOZU SOL VE SAĞ LASTİK DAYANAK SUSPENSİYON	Yön : Sol Ve Sağ Ağırlık : 0.045 kg / 0.099 lb Not : LASTİK DAYANAK SUSPENSİYON	1K0412303B
	VW12086 RADYATÖR TAKOZU SOL VE SAĞ RADYATÖR ÜST LASTİĞİ	Yön : Sol Ve Sağ Ağırlık : 0.024 kg / 0.053 lb Not : RADYATÖR ÜST LASTİĞİ	1K0121367F
	VW13006 DİREKSİYON KÖRÜĞÜ	Ağırlık : 0.145 kg / 0.320 lb	1K0423831A, 5C0423831
	VW13006K DİREKSİYON KÖRÜĞÜ SOL VE SAĞ 2 PİECES	Ağırlık : 0.29 kg / 0.639 lb	1K0423831A, 5C0423831
	VW14003 AKS KÖRÜĞÜ +KELEPÇE+YAĞ. DIŞ	Ağırlık : 0.25 kg / 0.551 lb	1K0 498 203, 1K0498203
	AU15001 AMORTİSÖR KÖRÜĞÜ ÖN	Şasi (Ön / Arka) : ÖN Ağırlık : 0,110 kg / 0.243 lb	6N0413175A









* Bu sayfada ve katalogdaki tüm araçların adları, markaları, modelleri, sembolleri, logoları, orjinal numaraları (oe) ve diğer üçüncü parti numaraları sadece referans amaçlı kullanılmaktadır.

PASSAT
B8
2015 - 2023

Resim	Ürün Kodu ve Açıklaması	Detay	OEM
	VW1019 ROTİL ÖN SAĞ Ø15,3 RB2538	Ağırlık : 0,555 kg / 1.224 lb Konik Ölçüsü : Ø15,3 Bağlantı Delik Çapı : Ø10,5 Aşık Diş Çapı : M12X1,5	3C0407366A
	VW1020 ROTİL ÖN SOL Ø15,3 RB2539	Ağırlık : 0,555 kg / 1.224 lb Konik Ölçüsü : Ø15,3 Bağlantı Delik Çapı : Ø10,5 Aşık Diş Çapı : M12X1,5	3C0407365A
	VW2008 ROTBAŞI ÖN SAĞ RD0342	Ağırlık : 0,412 kg / 0.908 lb Uzunluk : 95 mm / 3.74 inch Gövde Diş Çapı : M16X1,5 Aşık Diş Çapı : M12X1,5 Aşık Konik Çapı : Ø12,7	1K0423812A, 1K0423812C 1K0423812E, 1K0423812G 1K0423812J, 1K0423812K 1KD423812A
	VW2009 ROTBAŞI ÖN SOL RD0343	Ağırlık : 0,412 kg / 0.908 lb Uzunluk : 95 mm / 3.74 inch Gövde Diş Çapı : M16X1,5 Aşık Diş Çapı : M12X1,5 Aşık Konik Çapı : Ø13,5	1K0423811A, 1K0423811C 1K0423811E, 1K0423811G 1K0423811J, 1K0423811K 1KD423811A
	VW3021 ROTMİLİ SAĞ-SOL	Ağırlık : 0,705 kg / 1.554 lb Uzunluk : 330 mm / 12.99 inch	561423810
	VW20083021 ROT TAKIMI ÖN AKS SAĞ	Ağırlık : 1,2 kg / 2.646 lb Rotbaşı : VW2008 Rotmilî : VW3021	561423810, 561423810S1
	VW20093021 ROT TAKIMI ÖN SOL	Ağırlık : 1,2 kg / 2.646 lb Rotbaşı : VW2009 Rotmilî : VW3021	561423810 S2, 561423810
	SK4005 Z ROT ÖM SAĞ-SOL L=335MM	Ağırlık : 0,322 kg / 0.710 lb Malzeme Türü : Metal Uzunluk : 335 mm / 13.19 inch Aşık Diş Çapı : M12X1,5	5Q0411315B
	VW4014 Z ROT ÖN SAĞ-SOL METAL 335 RB2935	Ağırlık : 0,46 kg / 1.014 lb Malzeme Türü : Metal Uzunluk : 335 mm / 13.19 inch Aşık Diş Çapı : M12X1,5	1K0411315B, 1K0411315D 1K0411315J, 1K0411315K 1K0411315R, 5Q0411315A 5Q0411315B
	AU9012 SALINCAĞ ARKA ALT SAĞ	Ağırlık : 1,640 kg / 3.616 lb Malzeme Türü : Sac Metal	5Q0505224D
	AU9013 SALINCAĞ ARKA ALT SOL	Ağırlık : 1,640 kg / 3.616 lb Malzeme Türü : Sac Metal	5Q0505223D

* Bu sayfada ve katalogdaki tüm araçların adları, markaları, modelleri, sembolleri, logoları, orjinal numaraları (oe) ve diğer üçüncü parti numaraları sadece referans amaçlı kullanılmaktadır.

PASSAT
B8
2015 - 2023

Resim	Ürün Kodu ve Açıklaması	Detay	OEM
	SK9002 SALINCAK ALT SOL VE SAĞ	Ağırlık : 2,914 kg / 6.424 lb Malzeme Türü : Sac Metal	3Q0505311C, 3Q0505311D 3Q0505311E
	VW6055 SALINCAK ÖN ALT SAĞ	Ağırlık : 3,768 kg / 8.307 lb Malzeme Türü : Sac Metal	3Q0407152E*, 3Q0407152E 3Q0407152F*, 3Q0407152F 3Q0407154B*, 3Q0407154B
	VW6055J SALINCAK ÖN ALT SAĞ	Malzeme Türü : Sac Metal	3Q0407152E, 3Q0407152F 3Q0407154B
	VW6056 SALINCAK ÖN ALT SOL	Ağırlık : 3,768 kg / 8.307 lb Malzeme Türü : Sac Metal	3Q0407151E*, 3Q0407151E 3Q0407151F*, 3Q0407151F 3Q0407153B*, 3Q0407153B
	VW6056J SALINCAK ÖN ALT SOL	Malzeme Türü : Sac Metal	3Q0407151E, 3Q0407151F 3Q0407153B
	VW9005 SALINCAK ARKA ALT ÖNDEN	Ağırlık : 0,566 kg / 1.248 lb Malzeme Türü : Sac Metal	5Q0501529C, 5Q0501529D 5Q0501529E, 5Q0501529F
	VW9006 SALINCAK ALT SAĞ	Ağırlık : 1,992 kg / 4.392 lb Malzeme Türü : Sac Metal	3Q0505224
	VW9007 SALINCAK ALT SOL	Ağırlık : 1,992 kg / 4.392 lb Malzeme Türü : Sac Metal	3Q0505223
	AU11068 SALINCAK VE DENGE KOLU BURCU ARKA ALT SOL VE SAĞ METAL	Şasi (Ön / Arka) : ARKA Yön : Alt Sol Ve Sağ Ağırlık : 0,201 kg / 0.443 lb Malzeme Türü : Metal	PART OF 5Q0505223D, PART OF 5Q0505224D
	SK11006 SALINCAK VE DENGE KOLU BURCU ARKA ALT	Şasi (Ön / Arka) : ARKA Yön : Alt Ağırlık : 0,125 kg / 0.276 lb	3Q0505311C*, 3Q0505311D* 3Q0505311E*, 5Q0505171B*
	VW11042 SALINCAK VE DENGE KOLU BURCU ORTA SOL VE SAĞ	Yön : Orta Sol Ve Sağ Ağırlık : 0,182 kg / 0.401 lb	1K0407182, 5Q0407182



* Bu sayfada ve katalogdaki tüm araçların adları, markaları, modelleri, sembolleri, logoları, orjinal numaraları (oe) ve diğer üçüncü parti numaraları sadece referans amaçlı kullanılmaktadır.

PASSAT
B8
2015 - 2023

Resim	Ürün Kodu ve Açıklaması	Detay	OEM
	VW11063 SALINCAK VE DENGE KOLU BURCU SOL VE SAĞ	Yön : Sol Ve Sağ Ağırlık : 0.34 kg / 0.750 lb	5Q0407183D, 5Q0407183E
	VW11075 SALINCAK VE DENGE KOLU BURCU ARKA SOL VE SAĞ	Şasi (Ön / Arka) : ARKA Yön : Sol Ve Sağ Ağırlık : 0,870 kg / 1.918 lb Not : FORWARD and INNER	Part of 5Q0501529C, Part of 5Q0501529D Part of 5Q0501529E, Part of 5Q0501529F
	VW11076 SALINCAK VE DENGE KOLU BURCU ARKA SOL VE SAĞ	Şasi (Ön / Arka) : ARKA Yön : Sol Ve Sağ Ağırlık : 0,870 kg / 1.918 lb Not : FORWARD and OUTER	Part of 5Q0501529C, Part of 5Q0501529D Part of 5Q0501529E, Part of 5Q0501529F
	VW12109 AMORTİSÖR TAKOZU SOL VE SAĞ AMORTİSÖR RULMANI	Yön : Sol Ve Sağ Ağırlık : 0.26 kg / 0.573 lb Not : AMORTİSÖR RULMANI	6N0412249C, 6N0412249E
	VW12109K AMORTİSÖR TAKOZU SOL VE SAĞ 2 PCS	Yön : Sol Ve Sağ Ağırlık : 0.52 kg / 1.146 lb Not : 2 PCS	6N0412249C, 6N0412249E
	AU12022 MOTOR TAKOZU SOL VE SAĞ MOTOR TAKOZU	Yön : Sol Ve Sağ Ağırlık : 1.58 kg / 3.483 lb Malzeme Türü : Motor Takoğu	5Q0199262, 5Q0199262BH 5Q0199262DE
	AU12023 MOTOR TAKOZU SOL VE SAĞ MOTOR TAKOZU 7 İLERİ	Yön : Sol Ve Sağ Ağırlık : 1.58 kg / 3.483 lb Malzeme Türü : Motor Takoğu Not : 7 İLERİ	5Q0199262BE, 5Q0199262BF
	AU12026 MOTOR TAKOZU ÖN SOL VE SAĞ	Şasi (Ön / Arka) : ÖN Yön : Sol Ve Sağ Ağırlık : 0,850 kg / 1.874 lb	5Q0199855AD, 5Q0199855J 5Q0199855P, 5Q0199855Q
	VW12157 MOTOR TAKOZU ÖN SOL VE SAĞ	Şasi (Ön / Arka) : ÖN Yön : Sol Ve Sağ Ağırlık : 2.2 kg / 4.850 lb	5Q0199555AF, 5Q0199555T 5Q0199555AP
	VW12051 SÜSPANSİYON TAKOZU SOL VE SAĞ LASTİK DAYANAK SÜSPANSİYON	Yön : Sol Ve Sağ Ağırlık : 0.045 kg / 0.099 lb Not : LASTİK DAYANAK SÜSPANSİYON	1K0412303B
	VW12086 RADYATÖR TAKOZU SOL VE SAĞ RADYATÖR ÜST LASTİĞİ	Yön : Sol Ve Sağ Ağırlık : 0.024 kg / 0.053 lb Not : RADYATÖR ÜST LASTİĞİ	1K0121367F

* Bu sayfada ve katalogdaki tüm araçların adları, markaları, modelleri, sembolleri, logoları, orijinal numaraları (oe) ve diğer üçüncü parti numaraları sadece referans amaçlı kullanılmaktadır.

PASSAT
B8
2015 - 2023











Resim	Ürün Kodu ve Açıklaması	Detay	OEM
	VW13006 DİREKSİYON KÖRÜĞÜ	Ağırlık : 0.145 kg / 0.320 lb	1K0423831A, 5C0423831
	VW13006K DİREKSİYON KÖRÜĞÜ SOL VE SAĞ 2 PİECES	Ağırlık : 0.29 kg / 0.639 lb	1K0423831A, 5C0423831

PHAETON
3D
2002 - 2016

Resim	Ürün Kodu ve Açıklaması	Detay	OEM
	AU1020 ROTİL ARKA	Ağırlık : 0,141 kg / 0.311 lb	4E0501529C, 4E0501529D* 4E0501529D, 4E0501529G* 4E0501529G
	AU2218 ROTBAŞI ÖN SAĞ - SOL RB2218	Ağırlık : 0,654 kg / 1.442 lb Uzunluk : 161 mm / 6.34 inch Gövde Diş Çapı : M16X1,5 Aşık Diş Çapı : M8X1,25 Aşık Konik Çapı : Ø23	4E0419811B, 4E0419811C 4E0419811D, 4E0419811E
	AU3006 ROTMİLİ SAĞ-SOL RB2839	Ağırlık : 0,455 kg / 1.003 lb Uzunluk : 127 mm / 5.00 inch Gövde Diş Çapı : M16X1,5 Aşık Diş Çapı : M16X1,5	4E0419801C, 4E0419801D 4E0419821, 4E0419821C 4E0419821D
	AU20183006 ROT TAKIMI ÖN AKS RB288133	Ağırlık : 1,102 kg / 2.429 lb Rotbaşı : AU2018 Rotmili : AU3006	4E0419801C, 4E0419801D
	AU4012 Z ROT SAĞ RB2916	Ağırlık : 0,234 kg / 0.516 lb Uzunluk : 61,5 mm / 2.42 inch	4D0505548C, 4E0505548 4E0505548A, 4E0505548L
	AU4013 Z ROT SOL RB2917	Ağırlık : 0,237 kg / 0.522 lb Uzunluk : 61,5 mm / 2.42 inch	4D0505547C, 4E0505547 4E0505547A, 4E0505547L
	AU4019 RB2930 RIW Z ROT ÖN SAĞ-SOL	Ağırlık : 0,353 kg / 0.778 lb Malzeme Türü : Alüminyum Uzunluk : 110 mm / 4.33 inch	, 4E0411317C 4E0411317D, 4E0411317E
	AU4036 Z ROT SOL VE SAĞ METAL	Ağırlık : 0,227 kg / 0.500 lb Malzeme Türü : Metal Uzunluk : 94 mm / 3.70 inch	4E0505465G





* Bu sayfada ve katalogdaki tüm araçların adları, markaları, modelleri, sembolleri, logoları, orjinal numaraları (oe) ve diğer üçüncü parti numaraları sadece referans amaçlı kullanılmaktadır.

PHAETON
3D
2002 - 2016





Resim	Ürün Kodu ve Açıklaması	Detay	OEM
	AU5017 SALINCAK ÖN ÜST SAĞ RB2651	Malzeme Türü : Alüminyum	4E0407510B
	AU5018 SALINCAK ÖN ÜST SOL RB2650	Malzeme Türü : Alüminyum	4E0407509B
	AU5019 SALINCAK ÖN ÜST ÖNDEN SAĞ RB2643	Malzeme Türü : Alüminyum	4E0407506B
	AU5020 SALINCAK ÖN ÜST ÖNDEN SOL RB2642	Malzeme Türü : Alüminyum	4E0407505B
	AU5024 SALINCAK ÖN ALT SAĞ RB2645	Malzeme Türü : Alüminyum	4E0407694C, 4E0407694F 4E0407696B
	AU5025 SALINCAK ÖN ALT SOL RB2644	Malzeme Türü : Alüminyum	4E0407693C, 4E0407693F 4E0407695B
	AU5026 SALINCAK ÖN ALT RB2649	Malzeme Türü : Alüminyum	4E0407151G, 4E0407151L 4E0407155C
	AU5055 SALINCAK ARKA ALT	Malzeme Türü : Alüminyum	4E0501529D, 4E0501529G
	AU11032 SALINCAK VE DENGİ KOLU BURCU ÖN SOL VE SAĞ	Şasi (Ön / Arka) : ÖN Yön : Sol Ve Sağ Ağırlık : 0,17 kg / 0.375 lb Not : DENGİ KOLU BURCU	4D0407183L, 4F0407183A 4F0407183B, 4F0407183E
	AU11036 SALINCAK VE DENGİ KOLU BURCU ÖN SOL VE SAĞ	Şasi (Ön / Arka) : ÖN Yön : Sol Ve Sağ Ağırlık : 0,25 kg / 0.551 lb Not : DENGİ KOLU BURCU	4H0407515, 8D0407515A 8K0407515, 8R0407515
	AU11042 SALINCAK VE DENGİ KOLU BURCU ALT SOL VE SAĞ	Yön : Alt Sol Ve Sağ Ağırlık : 0,16 kg / 0.353 lb	4E0407182C

* Bu sayfada ve katalogdaki tüm araçların adları, markaları, modelleri, sembolleri, logoları, orjinal numaraları (oe) ve diğer üçüncü parti numaraları sadece referans amaçlı kullanılmaktadır.

PHAETON
3D
2002 - 2016

Resim	Ürün Kodu ve Açıklaması	Detay	OEM
	AU11043 SALINCAK VE DENGE KOLU BURCU ÖN ALT ORTA SOL VE SAĞ B22137	Şasi (Ön / Arka) : ÖN Yön : Alt Orta Sol Ve Sağ Ağırlık : 0,1 kg / 0.220 lb	4E0407181B
	AU11044 SALINCAK VE DENGE KOLU BURCU ALT ORTA SOL VE SAĞ	Yön : Alt Orta Sol Ve Sağ Ağırlık : 0,1 kg / 0.220 lb	4E0407183B
	AU11045 SALINCAK VE DENGE KOLU BURCU ÜST SOL VE SAĞ	Yön : Üst Sol Ve Sağ Ağırlık : 0,1 kg / 0.220 lb	4E0407515D, 8D0407515B 8K0407515
	AU11059 SALINCAK VE DENGE KOLU BURCU ARKA ALT SOL VE SAĞ	Şasi (Ön / Arka) : ARKA Yön : Alt Sol Ve Sağ Ağırlık : 0,127 kg / 0.280 lb	4E0501529D*, 4E0501529D-P 4E0501529G*, 4E0501529G-P Part of 4E0501529D, Part of 4E0501529G
	AU11079 Z-ROT BURCU ARKA	Şasi (Ön / Arka) : ARKA Ağırlık : 0,055 kg / 0.121 lb Uzunluk : AU4012 mm / 0.00 inch Aşık Dış Çapı : AU4013	4D0505547C*, 4E0505547L*

POINTER
GOL
1998 - 2008







Resim	Ürün Kodu ve Açıklaması	Detay	OEM
	AU1003 ROTİL ÖN SAĞ RB2515	Ağırlık : 0,58 kg / 1.279 lb Bağlantı Delik Çapı : Ø10,5	855407366A, 855407366B
	AU1004 ROTİL ÖN SOL RB2514	Ağırlık : 0,58 kg / 1.279 lb Bağlantı Delik Çapı : Ø10,5	855407365A, 855407365B
	VW1016 ROTİL ÜST SOL VE SAĞ Ø20 RD0415	Ağırlık : 0,68 kg / 1.499 lb Konik Ölçüsü : Ø20 Aşık Dış Çapı : M18X1,5 Rotil Gövde Çapı : Ø48,4	211405371A, 211405371B
	AU2213 ROTBAŞI ÖN SAĞ - SOL RB2213	Ağırlık : 0,315 kg / 0.694 lb Uzunluk : 100 mm / 3.94 inch Gövde Dış Çapı : M14X1,5 Aşık Dış Çapı : M10X1 Aşık Konik Çapı : Ø10,6	321419811, 811419812 823419811, 861419802 861419812
	VW2027 ROTBAŞI 60 MM	Ağırlık : 0,282 kg / 0.622 lb Uzunluk : 60 mm / 2.36 inch Gövde Dış Çapı : M14X1,5 Aşık Dış Çapı : M10X1,25 Aşık Konik Çapı : Ø10,8	307419812.1

* Bu sayfada ve katalogdaki tüm araçların adları, markaları, modelleri, sembolleri, logoları, orijinal numaraları (oe) ve diğer üçüncü parti numaraları sadece referans amaçlı kullanılmaktadır.

POINTER
GOL
1998 - 2008

Resim	Ürün Kodu ve Açıklaması	Detay	OEM
	AU11046 SALINCAK VE DENGE KOLU BURCU SOL VE SAĞ	Yön : Sol Ve Sağ Ağırlık : 0,118 kg / 0.260 lb	811407181, 811407181A
	AU11046K SALINCAK VE DENGE KOLU BURCU SOL VE SAĞ	Yön : Sol Ve Sağ Ağırlık : 0,236 kg / 0.520 lb	811407181, 811407181A



POINTER
PICKUP
1997 - 2010

Resim	Ürün Kodu ve Açıklaması	Detay	OEM
	AU1003 ROTİL ÖN SAĞ RB2515	Ağırlık : 0,58 kg / 1.279 lb Bağlantı Delik Çapı : Ø10,5	855407366A, 855407366B
	AU1004 ROTİL ÖN SOL RB2514	Ağırlık : 0,58 kg / 1.279 lb Bağlantı Delik Çapı : Ø10,5	855407365A, 855407365B
	VW1016 ROTİL ÜST SOL VE SAĞ Ø20 RD0415	Ağırlık : 0,68 kg / 1.499 lb Konik Ölçüsü : Ø20 Aşık Diş Çapı : M18X1,5 Rotil Gövde Çapı : Ø48,4	211405371A, 211405371B
	AU2213 ROTBAŞI ÖN SAĞ - SOL RB2213	Ağırlık : 0,315 kg / 0.694 lb Uzunluk : 100 mm / 3.94 inch Gövde Diş Çapı : M14X1,5 Aşık Diş Çapı : M10X1 Aşık Konik Çapı : Ø10,6	321419811, 811419812 823419811, 861419802 861419812
	VW2027 ROTBAŞI 60 MM	Ağırlık : 0,282 kg / 0.622 lb Uzunluk : 60 mm / 2.36 inch Gövde Diş Çapı : M14X1,5 Aşık Diş Çapı : M10X1,25 Aşık Konik Çapı : Ø10,8	307419812.1
	AU11046 SALINCAK VE DENGE KOLU BURCU SOL VE SAĞ	Yön : Sol Ve Sağ Ağırlık : 0,118 kg / 0.260 lb	811407181, 811407181A
	AU11046K SALINCAK VE DENGE KOLU BURCU SOL VE SAĞ	Yön : Sol Ve Sağ Ağırlık : 0,236 kg / 0.520 lb	811407181, 811407181A

POLO
2003 - 2007

Resim	Ürün Kodu ve Açıklaması	Detay	OEM
	VW3018 ROTMİLİ ÖN SAĞ-SOL	Ağırlık : 0,552 kg / 1.217 lb Uzunluk : 297 mm / 11.69 inch Gövde Diş Çapı : M14X1,5 Aşık Diş Çapı : M14X1,5	6X0422803, 6X0422804 6X0422807, 6X0422821

POLO
II 86
1974 - 1994

Resim	Ürün Kodu ve Açıklaması	Detay	OEM
	AU2213 ROTBAŞI ÖN SAĞ - SOL RB2213	Ağırlık : 0,315 kg / 0.694 lb Uzunluk : 100 mm / 3.94 inch Gövde Diş Çapı : M14X1,5 Aşık Diş Çapı : M10X1 Aşık Konik Çapı : Ø10,6	321419811, 811419812 823419811, 861419802 861419812
	VW5001 SALINCAK ÖN	Ağırlık : 1,336 kg / 2.945 lb Malzeme Türü : Dövme Çelik	861407151A
	VW5002 SALINCAK ÖN	Ağırlık : 1,370 kg / 3.020 lb Malzeme Türü : Dövme Çelik	861407151B
	VW7004 ARA ROT ÖN AKS	Şasi (Ön / Arka) : ÖN Yön : Sol Ve Sağ Ağırlık : 1.22 kg / 2.690 lb Rotbaşı 1 : VW11028	871419802
	VW7005 ARA ROT ARKA AKS SAĞ BUSH = VW11028	Şasi (Ön / Arka) : ÖN Yön : Sağ Diğer Taraf : VW7006 Ağırlık : 1,167 kg / 2.573 lb Uzunluk : 515 mm / 20.28 inch	871419801A
	VW7006 ARA ROT ARKA AKS SOL BUSH = VW11028	Şasi (Ön / Arka) : ÖN Yön : Sol Diğer Taraf : VW7005 Ağırlık : 1,161 kg / 2.560 lb Uzunluk : 515 mm / 20.28 inch	872419802A
	VW11003 SALINCAK VE DENGİ KOLU BURCU SOL VE SAĞ B22129	Yön : Sol Ve Sağ Ağırlık : 0,126 kg / 0.278 lb	823407181, 861407181
	VW11027 SALINCAK VE DENGİ KOLU BURCU ORTA SOL VE SAĞ B40126	Yön : Orta Sol Ve Sağ Ağırlık : 0,082 kg / 0.181 lb	861407183
	VW11028 SALINCAK VE DENGİ KOLU BURCU ORTA SOL VE SAĞ	Yön : Orta Sol Ve Sağ Ağırlık : 0,056 kg / 0.123 lb	

* Bu sayfada ve katalogdaki tüm araçların adları, markaları, modelleri, sembolleri, logoları, orijinal numaraları (oe) ve diğer üçüncü parti numaraları sadece referans amaçlı kullanılmaktadır.

POLO
II 86
1974 - 1994











Resim	Ürün Kodu ve Açıklaması	Detay	OEM
	AU12012 EGZOZ TAKOZU ÖN SOL VE SAĞ EGSOZ LASTİĞİ	Şasi (Ön / Arka) : ÖN Yön : Sol Ve Sağ Ağırlık : 0.034 kg / 0.075 lb Not : EGSOZ LASTİĞİ	191253147B, 4A0253147A
	VW14014 AKS KÖRÜĞÜ +KELEPÇE+YAĞ. YAĞ+KELEPÇE	Ağırlık : 0.28 kg / 0.617 lb	191498203C, 71498203

POLO
III 6N1
1994 - 2001

Resim	Ürün Kodu ve Açıklaması	Detay	OEM
	VW1028 ROTİL ÖN SAĞ Ø14,7	Ağırlık : 0,39 kg / 0.860 lb Konik Ölçüsü : Ø14,7 Bağlantı Delik Çapı : Ø8,5 Aşık Diş Çapı : M10X1	6N0407366
	VW1028K ROTİL ALT SAĞ RD0523	Ağırlık : 0,455 kg / 1.003 lb Konik Ölçüsü : Ø14,7 Bağlantı Delik Çapı : Ø8,5 Aşık Diş Çapı : M10X1	6E0307366, 6N0407366* 6N0407366A
	VW1029 ROTİL ÖN SOL Ø14,7	Ağırlık : 0,39 kg / 0.860 lb Konik Ölçüsü : Ø14,7 Bağlantı Delik Çapı : Ø8,5 Aşık Diş Çapı : M10X1	6N0407365, 6N0407365A
	VW1029K ROTİL ALT SOL RD0524	Ağırlık : 0,455 kg / 1.003 lb Konik Ölçüsü : Ø14,7 Bağlantı Delik Çapı : Ø8,5 Aşık Diş Çapı : M10X1	6N0407365*, 6N0407365 6N0407365A
	SE2003 ROTBAŞI SAĞ	Ağırlık : 0,37 kg / 0.816 lb Uzunluk : 92 mm / 3.62 inch Gövde Diş Çapı : M14X1,5 Aşık Diş Çapı : M12X1,5 Aşık Konik Çapı : Ø12,6	1J0422812E, 3A0422812 3A0422812A
	SE2004 ROTBAŞI SOL	Ağırlık : 0,37 kg / 0.816 lb Uzunluk : 92 mm / 3.62 inch Gövde Diş Çapı : M14X1,5 Aşık Diş Çapı : M12X1,5 Aşık Konik Çapı : Ø12,6	1J0422811E, 3A0422811 3A0422811A
	VW2006 ROTBAŞI SAĞ RD0312	Ağırlık : 0,3 kg / 0.661 lb Uzunluk : 76 mm / 2.99 inch Gövde Diş Çapı : M14X1,5 Aşık Diş Çapı : M12X1,5 Aşık Konik Çapı : Ø12,7	191419812, 22190091617 6N0419812, 6N0422812 XA2087
	VW2007 ROTBAŞI SOL RD0311	Ağırlık : 0,3 kg / 0.661 lb Uzunluk : 76 mm / 2.99 inch Gövde Diş Çapı : M14X1,5 Aşık Diş Çapı : M12X1,5 Aşık Konik Çapı : Ø12,7	191419811, 22190090617 6N0419811, 6N0422811 XA2084











* Bu sayfada ve katalogdaki tüm araçların adları, markaları, modelleri, sembolleri, logoları, orjinal numaraları (oe) ve diğer üçüncü parti numaraları sadece referans amaçlı kullanılmaktadır.

POLO
III 6N1
1994 - 2001

Resim	Ürün Kodu ve Açıklaması	Detay	OEM
	VW2022 ROTBAŞI SAĞ RD0336	Ağırlık : 0,357 kg / 0.787 lb Uzunluk : 93,5 mm / 3.68 inch Gövde Diş Çapı : M14X1,5 Aşık Diş Çapı : M12X1,5 Aşık Konik Çapı : Ø12,6	6E0419812, 6K0422812 6X0422812, 8Z0419812A
	VW2023 ROTBAŞI SOL RD0335	Ağırlık : 0,354 kg / 0.780 lb Uzunluk : 93,5 mm / 3.68 inch Gövde Diş Çapı : M14X1,5 Aşık Diş Çapı : M12X1,5 Aşık Konik Çapı : Ø12,6	6E0419811, 6K0422811 6X0422811, 8Z0419811A
	SE3002 ROTMİLİ SOL VE SAĞ 318	Ağırlık : 0,578 kg / 1.274 lb Uzunluk : 318 mm / 12.52 inch	6K0422803D, 6K0422804D 6K0422807D
	SK3003 ROTMİLİ SAĞ-SOL 297	Ağırlık : 0,552 kg / 1.217 lb Uzunluk : 297 mm / 11.69 inch Gövde Diş Çapı : M14X1,5 Aşık Diş Çapı : M14X1,5	6Q0 423 821 B, 6Q0423821B 6X0422803, 6X0422804 6X0422807, 6X0422821
	VW3015 ROTMİLİ SAĞ-SOL HİDROLİK 309 RD0867	Ağırlık : 0,592 kg / 1.305 lb Uzunluk : 313 mm / 12.32 inch Gövde Diş Çapı : M14X1,5 Aşık Diş Çapı : M14X1,5	6N0422803A, 6N0422804A 6N0422807A, 6N0422821A 6X0422821
	VW3016 ROTMİLİ SAĞ-SOL MANUEL 321 RD0864	Ağırlık : 0,602 kg / 1.327 lb Uzunluk : 296 mm / 11.65 inch Gövde Diş Çapı : M22X1,5 Aşık Diş Çapı : M14X1,5	6N0419803, 6N0419804 6N0419821
	VW3018 ROTMİLİ ÖN SAĞ-SOL	Ağırlık : 0,552 kg / 1.217 lb Uzunluk : 297 mm / 11.69 inch Gövde Diş Çapı : M14X1,5 Aşık Diş Çapı : M14X1,5	6X0422803, 6X0422804 6X0422807, 6X0422821
	VW3022 ROTMİLİ SAĞ-SOL L=292MM	Ağırlık : 0,57 kg / 1.257 lb Uzunluk : 292 mm / 11.50 inch Gövde Diş Çapı : M14X1,5 Aşık Diş Çapı : M14X1,5	6N0422803C*, 6N0422803C 6N0422804C*, 6N0422804C
	SE20033002 ROT TAKIMI ÖN AKS SAĞ	Ağırlık : 0,96 kg / 2.116 lb Rotbaşı : SE2003 Rotmilî : SE3002	6K0422804A, 6K0422804D
	SE20043002 ROT TAKIMI ÖN AKS SOL	Ağırlık : 0,96 kg / 2.116 lb Rotbaşı : SE2004 Rotmilî : SE3002	6K0422803A, 6K0422803D
	VW20063015 ROT TAKIMI ÖN AKS SAĞ RD088165	Ağırlık : 0,89 kg / 1.962 lb Rotbaşı : VW2006 Rotmilî : VW3015	6N0422804A









* Bu sayfada ve katalogdaki tüm araçların adları, markaları, modelleri, sembolleri, logoları, orjinal numaraları (oe) ve diğer üçüncü parti numaraları sadece referans amaçlı kullanılmaktadır.

POLO
III 6N1
1994 - 2001

Resim	Ürün Kodu ve Açıklaması	Detay	OEM
	VW20063016 ROT TAKIMI ÖN AKS SAĞ RD088163	Ağırlık : 0,91 kg / 2.006 lb Rotbaşı : VW2006 Rotmili : VW3016	3A0419804, 6N0419804 6N0419804A, 6X0419804A
	VW20073015 ROT TAKIMI ÖN AKS SOL RD088166	Ağırlık : 0,893 kg / 1.969 lb Rotbaşı : VW2007 Rotmili : VW3015	6N0422803A
	VW20073016 ROT TAKIMI ÖN AKS SOL RD088145	Ağırlık : 0,916 kg / 2.019 lb Rotbaşı : VW2007 Rotmili : VW3016	155422803, 175422803 55422803A, 6N0419803A 6X0419803A
	VW20223022 ROT TAKIMI ÖN AKS SAĞ	Ağırlık : 0,94 kg / 2.072 lb Rotbaşı : VW2022 Rotmili : VW3022	6N0422804C
	VW20233022 ROT TAKIMI SOL	Ağırlık : 0,94 kg / 2.072 lb Rotbaşı : VW2023 Rotmili : VW3022	6N0422803C
	VW4022 Z ROT ÖN SAĞ-SOL 18MM 75 RD0931	Ağırlık : 0,166 kg / 0.366 lb Malzeme Türü : Metal Uzunluk : 76 mm / 2.99 inch Aşık Dış Çapı : M8X1,25	6N0411315A, 6N0411315D
	VW4025 Z ROT ÖN SAĞ-SOL 15MM 75 RD0925	Ağırlık : 0,173 kg / 0.381 lb Uzunluk : 30 mm / 1.18 inch	6N0411315
	VW6023 SALINCAK ÖN SAĞ RD1023	Ağırlık : 2,49 kg / 5.490 lb Malzeme Türü : Sac Metal	6N0407151*, 6N0407151A 6N0407365A*, 6X0407151A
	VW6023J SALINCAK ÖN RD1107	Ağırlık : 2,05 kg / 4.519 lb Malzeme Türü : Sac Metal	6N0407151, 6N0407151B
	VW6024 SALINCAK ÖN SOL RD1024	Ağırlık : 2,319 kg / 5.113 lb Malzeme Türü : Sac Metal	6N0407151*, 6N0407365*
	VW11022 SALINCAK VE DENGE KOLU BURCU ORTA SOL VE SAĞ B40122	Yön : Orta Sol Ve Sağ Ağırlık : 0,081 kg / 0.179 lb	6N0407182







* Bu sayfada ve katalogdaki tüm araçların adları, markaları, modelleri, sembolleri, logoları, orijinal numaraları (oe) ve diğer üçüncü parti numaraları sadece referans amaçlı kullanılmaktadır.

POLO
III 6N1
1994 - 2001



Resim	Ürün Kodu ve Açıklaması	Detay	OEM
	VW11041 SALINCAK VE DENGE KOLU BURCU SOL VE SAĞ B40121	Yön : Sol Ve Sağ Ağırlık : 0,156 kg / 0.344 lb	, 6N0407181
	VW12068 TORSİYON BURCU ARKA SOL VE SAĞ	Şasi (Ön / Arka) : ARKA Yön : Sol Ve Sağ Ağırlık : 0.166 kg / 0.366 lb	6N0501541, 6N0501541D
	VW12068K TORSİYON BURCU ARKA SOL VE SAĞ	Şasi (Ön / Arka) : ARKA Yön : Sol Ve Sağ Ağırlık : 0.332 kg / 0.732 lb	6N0501541, 6N0501541D
	VW12053 VİRAJ DEMİR LASTİĞİ SOL VE SAĞ RUBBER	Şasi (Ön / Arka) : ÖN Yön : Sol Ve Sağ Ağırlık : 0.06 kg / 0.132 lb Malzeme Türü : Rubber Not : VİRAJ LASTİĞİ	1H0411314
	VW12053K VİRAJ DEMİR LASTİĞİ SOL VE SAĞ RUBBER	Şasi (Ön / Arka) : ÖN Yön : Sol Ve Sağ Ağırlık : 0.12 kg / 0.265 lb Malzeme Türü : Rubber	1H0411314*
	VW12111 VİRAJ DEMİR LASTİĞİ SOL VE SAĞ RUBBER	Şasi (Ön / Arka) : ÖN Yön : Sol Ve Sağ Ağırlık : 0.015 kg / 0.033 lb Malzeme Türü : Rubber Not : VİRAJ LASTİĞİ	191411329, 6N0411329
	VW12111K VİRAJ DEMİR LASTİĞİ SOL VE SAĞ RUBBER	Şasi (Ön / Arka) : ÖN Yön : Sol Ve Sağ Ağırlık : 0.03 kg / 0.066 lb Malzeme Türü : Rubber	191411329*, 6N0411329*
	VW12005 AMORTİSÖR TAKOZU SOL VE SAĞ AMORTİSÖR ÜST TAKOZU	Yön : Sol Ve Sağ Ağırlık : 0.1 kg / 0.220 lb Not : AMORTİSÖR ÜST TAKOZU	191512333
	VW12109 AMORTİSÖR TAKOZU SOL VE SAĞ AMORTİSÖR RULMANI	Yön : Sol Ve Sağ Ağırlık : 0.26 kg / 0.573 lb Not : AMORTİSÖR RULMANI	6N0412249C, 6N0412249E
	VW12109K AMORTİSÖR TAKOZU SOL VE SAĞ 2 PCS	Yön : Sol Ve Sağ Ağırlık : 0.52 kg / 1.146 lb Not : 2 PCS	6N0412249C, 6N0412249E
	VW12115 AMORTİSÖR TAKOZU SOL VE SAĞ AMORTİSÖR TAKOZU	Yön : Sol Ve Sağ Ağırlık : 0.85 kg / 1.874 lb Not : AMORTİSÖR TAKOZU	6N0412331D, 6N0412331E 6Q0412331B

* Bu sayfada ve katalogdaki tüm araçların adları, markaları, modelleri, sembolleri, logoları, orijinal numaraları (oe) ve diğer üçüncü parti numaraları sadece referans amaçlı kullanılmaktadır.

POLO III 6N1 1994 - 2001







Resim	Ürün Kodu ve Açıklaması	Detay	OEM
	VW12801 AMORTİSÖR TAKOZU SOL VE SAĞ KIT = VW12115 AND VW12109	Yön : Sol Ve Sağ Ağırlık : 1.269 kg / 2.798 lb Not : KIT = VW12115 and VW12109	6N0412249C, 6N0412249E 6N0412331D, 6N0412331E 6Q0412331B
	VW12040 MOTOR TAKOZU SOL VE SAĞ MOTOR TAKOZU	Yön : Sol Ve Sağ Ağırlık : 1.641 kg / 3.618 lb Not : MOTOR TAKOZU	1J0199555AA, 1J0199555AK
	VW12072 MOTOR TAKOZU SOL VE SAĞ ŞANZIMAN TAKOZU	Yön : Sol Ve Sağ Ağırlık : 1.628 kg / 3.589 lb Not : ŞANZIMAN TAKOZU	6N0199555H
	VW12079 MOTOR TAKOZU SOL VE SAĞ ŞANZUMAN TAKOZU	Yön : Sol Ve Sağ Ağırlık : 1.44 kg / 3.175 lb Not : ŞANZUMAN TAKOZU	6N0199555AA, 6N0199555E 6N0199555F, 6N0199555G
	VW12135 EGZOZ TAKOZU	Ağırlık : 0,155 kg / 0.342 lb	1H0253144, 1H0253144A 1H0253144C, 1H0253409C 6N0253144
	VW13007 DİREKSİYON KÖRÜĞÜ	Ağırlık : 0.128 kg / 0.282 lb	6N0422831
	OP14003 AKS KÖRÜĞÜ +KELEPÇE+YAĞ. AKS KÖRÜĞÜ DIŞ	Ağırlık : 0.2 kg / 0.441 lb	1603180

POLO IV 9N 2001 - 2009

Resim	Ürün Kodu ve Açıklaması	Detay	OEM
	SK1023 ROTİL SAĞ RD0530	Ağırlık : 0,46 kg / 1.014 lb Konik Ölçüsü : Ø15 Bağlantı Delik Çapı : Ø8,5 Aşık Dış Çapı : M12X1,5	6Q0407366A, 6Q0407366B 6Q0407366E, 6Q0407366M 8Z0407366A
	SK1023K ROTİL ÖN ALT SAĞ Ø15 KIT	Ağırlık : 0,5 kg / 1.102 lb Konik Ölçüsü : Ø15 Bağlantı Delik Çapı : Ø8,5 Aşık Dış Çapı : M12X1,5	6Q0407366A*, 6Q0407366A 6Q0407366B*, 6Q0407366E* 6Q0407366M*, 6Q0407366M 8Z0407366A*
	SK1024 ROTİL SOL RD0531	Ağırlık : 0,46 kg / 1.014 lb Konik Ölçüsü : Ø15 Bağlantı Delik Çapı : Ø8,5 Aşık Dış Çapı : M12X1,5	6Q0407365A, 6Q0407365B 6Q0407365E, 6Q0407365M 8Z0407365A

* Bu sayfada ve katalogdaki tüm araçların adları, markaları, modelleri, sembolleri, logoları, orijinal numaraları (oe) ve diğer üçüncü parti numaraları sadece referans amaçlı kullanılmaktadır.





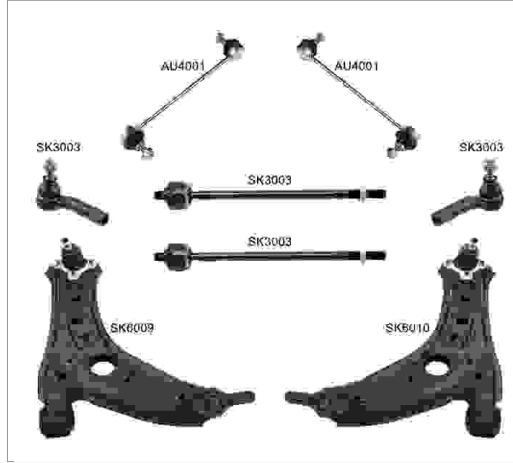





POLO
IV 9N
2001 - 2009

Resim	Ürün Kodu ve Açıklaması	Detay	OEM
	SK1024K ROTİL SOL	Ağırlık : 0,5 kg / 1.102 lb Konik Ölçüsü : Ø15 Bağlantı Delik Çapı : Ø8,5 Aşık Dış Çapı : M12X1,5	6Q0407365A*, 6Q0407365A 6Q0407365B*, 6Q0407365E* 6Q0407365E, 6Q0407365M* 6Q0407365M, 8Z0407365A*
	SK2003 ROTBAŞI SAĞ RC7314	Ağırlık : 0,377 kg / 0.831 lb Uzunluk : 93,5 mm / 3.68 inch Gövde Dış Çapı : M14X1,5 Aşık Dış Çapı : M12X1,5 Aşık Konik Çapı : Ø13,5	5Z0423812, 6Q0419812C 6Q0423812, 6Q0423812A 6Q0423812C, 6Q0423812D 6R0423812, 8Z0423811A
	SK2004 ROTBAŞI SOL RC7313	Ağırlık : 0,382 kg / 0.842 lb Uzunluk : 93 mm / 3.66 inch Gövde Dış Çapı : M14X1,5 Aşık Dış Çapı : M12X1,5 Aşık Konik Çapı : Ø13,5	5Z0423811, 6Q0419811C 6Q0423811, 6Q0423811A 6Q0423811C, 6Q0423811D 6R0423811, 8Z0423812A
	SK3003 ROTMİLİ SAĞ-SOL 297	Ağırlık : 0,552 kg / 1.217 lb Uzunluk : 297 mm / 11.69 inch Gövde Dış Çapı : M14X1,5 Aşık Dış Çapı : M14X1,5	6Q0 423 821 B, 6Q0423821B 6X0422803, 6X0422804 6X0422807, 6X0422821
	SK3004 ROTMİLİ SAĞ-SOL 300 RC7817	Ağırlık : 0,536 kg / 1.182 lb Uzunluk : 300 mm / 11.81 inch Gövde Dış Çapı : M16X1,5 Aşık Dış Çapı : M14X1,5	6Q0423803A, 6Q0423804A 6Q0-423-810-C, 6Q0423821A 6Q0423821C, 6Q0423821G
	SK3007 ROTMİLİ SAĞ-SOL	Ağırlık : 0,561 kg / 1.237 lb Uzunluk : 311 mm / 12.24 inch Gövde Dış Çapı : M14X1,5 Aşık Dış Çapı : M14X1,5	6Q0419803B, 6Q0419803D 6Q0419803F, 6Q0419804B 6Q0419804D, 6Q0419804F
	VW3018 ROTMİLİ ÖN SAĞ-SOL	Ağırlık : 0,552 kg / 1.217 lb Uzunluk : 297 mm / 11.69 inch Gövde Dış Çapı : M14X1,5 Aşık Dış Çapı : M14X1,5	6X0422803, 6X0422804 6X0422807, 6X0422821

SK8001 / Süspansiyon Kit
POLO
IV 9N
2001 - 2009

Kit Parçaları

Resim	Ürün Kodu / Adı	OEM	OEM	Ürün Kodu / Adı	Resim
	AU4001 Z Rot Sol Ve Sağ Metal Rb2911	893407465, 893407465A 8A0407465, 8A0407465B 8A0407465C	5Z0423812, 6Q0419812C 6Q0423812, 6Q0423812A 6Q0423812C, 6Q0423812D 6R0423812, 8Z0423811A	SK2003 Rotbaşı Sağ Rc7314	
	SK2004 Rotbaşı Sol Rc7313	5Z0423811, 6Q0419811C 6Q0423811, 6Q0423811A 6Q0423811C, 6Q0423811D 6R0423811, 8Z0423812A	6Q0 423 821 B, 6Q0423821B 6X0422803, 6X0422804 6X0422807, 6X0422821	SK3003 Rotmili Sağ-sol 297	
	SK6009 Salıncak Ön Alt Sağ Rd1035	6N0407151, 6Q0407151D* 6Q0407151D, 6Q0407151E* 6Q0407151E, 6Q0407151L 6Q0407151Z, 6Q0407366A*	6N040711, 6Q0407151D* 6Q0407151D, 6Q0407151E* 6Q0407151E, 6Q0407151L 6Q0407151Z, 6Q0407365A*	SK6010 Salıncak Ön Alt Sol Rd1036	

POLO
IV 9N
2001 - 2009

Resim	Ürün Kodu ve Açıklaması	Detay	OEM
	SK20033003 ROT TAKIMI ÖN AKS SAĞ RC788115	Ağırlık : 1,021 kg / 2.251 lb Rotbaşı : SK2003 Rotmili : SK3003	6Q0422804B, 6Q0423804B
	SK20033004 ROT TAKIMI ÖN AKS SAĞ RC788117	Ağırlık : 0,915 kg / 2.017 lb Rotbaşı : SK2003 Rotmili : SK3004	6Q0422804G, 6Q0423804A
	SK20033007 ROT TAKIMI ÖN AKS SAĞ	Ağırlık : 0,96 kg / 2.116 lb Rotbaşı : SK2003 Rotmili : SK3007	
	SK20043003 ROT TAKIMI SOL RC788114	Ağırlık : 0,932 kg / 2.055 lb Rotbaşı : SK2004 Rotmili : SK3003	6Q0422803B, 6Q0423803B
	SK20043004 ROT TAKIMI ÖN AKS SOL RC788116	Ağırlık : 0,903 kg / 1.991 lb Rotbaşı : SK2004 Rotmili : SK3004	6Q0422803G, 6Q0423803A
	SK20043007 ROT TAKIMI ÖN AKS SOL	Ağırlık : 0,96 kg / 2.116 lb Rotbaşı : SK2004 Rotmili : SK3007	
	AU4001 Z ROT SOL VE SAĞ METAL RB2911	Ağırlık : 0,357 kg / 0.787 lb Malzeme Türü : Metal Uzunluk : 270 mm / 10.63 inch Aşık Diş Çapı : M10X1,5	893407465, 893407465A 8A0407465, 8A0407465B 8A0407465C
	AU4001A Z ROT ÖN PLASTİK	Ağırlık : 0,295 kg / 0.650 lb Malzeme Türü : Plastik Uzunluk : 317 mm / 12.48 inch	893407465, 893407465A 8A0407465, 8A0407465B 8A0407465C
	AU4028 Z ROT ÖN	Ağırlık : 0,368 kg / 0.811 lb Malzeme Türü : Metal Uzunluk : 270 mm / 10.63 inch Aşık Diş Çapı : M10X1,5	6Q0411315L, 6Q0411315N 8Z0411315D
	VW4024 Z ROT SOL VE SAĞ METAL	Ağırlık : 0,379 kg / 0.836 lb Malzeme Türü : Metal Uzunluk : 270 mm / 10.63 inch Not : RD0946-RB3923-RD0930	6Q0411315B, 6Q0411315C 6Q0411315D, 6Q0411315F 6Q0411315G, 893407465 8A0407465
	SK6009 SALINCAK ÖN ALT SAĞ RD1035	Ağırlık : 2,676 kg / 5.900 lb Malzeme Türü : Sac Metal	6N0407151, 6Q0407151D* 6Q0407151D, 6Q0407151E* 6Q0407151E, 6Q0407151L 6Q0407151Z, 6Q0407366A*

* Bu sayfada ve katalogdaki tüm araçların adları, markaları, modelleri, sembolleri, logoları, orjinal numaraları (oe) ve diğer üçüncü parti numaraları sadece referans amaçlı kullanılmaktadır.

POLO
IV 9N
2001 - 2009

Resim	Ürün Kodu ve Açıklaması	Detay	OEM
	SK6009J SALINCAK ÖN ALT RD10211	Ağırlık : 2,626 kg / 5.789 lb Malzeme Türü : Sac Metal	6Q0407151D, 6Q0407151E 6Q0407151L
	SK6009K SALINCAK ÖN ALT SAĞ	Ağırlık : 3,13 kg / 6.900 lb Malzeme Türü : Sac Metal	6N0407151, 6Q0407151D 6Q0407151E, 6Q0407151L 6Q0407151Z
	SK6010 SALINCAK ÖN ALT SOL RD1036	Ağırlık : 3,13 kg / 6.900 lb Malzeme Türü : Sac Metal	6N040711, 6Q0407151D* 6Q0407151D, 6Q0407151E* 6Q0407151E, 6Q0407151L 6Q0407151Z, 6Q0407365A*
	SK6010K SALINCAK ÖN ALT SOL	Ağırlık : 3,13 kg / 6.900 lb Malzeme Türü : Sac Metal	6N040711, 6Q0407151D* 6Q0407151D, 6Q0407151E* 6Q0407151E, 6Q0407151L 6Q0407151Z, 6Q0407365A*
	VW11045 SALINCAK VE DENGE KOLU BURCU ORTA SOL VE SAĞ B40128	Yön : Orta Sol Ve Sağ Ağırlık : 0,145 kg / 0.320 lb	6Q0407182A
	VW11047 SALINCAK VE DENGE KOLU BURCU İÇ SOL VE SAĞ B37117	Yön : İç Sol Ve Sağ Ağırlık : 0,121 kg / 0.267 lb	1K0199231J, 1K0199231J-P 1K0407183E
	VW11051 SALINCAK VE DENGE KOLU BURCU SOL VE SAĞ	Yön : Sol Ve Sağ Ağırlık : 0.121 kg / 0.267 lb	6Q0407183, 6Q0407183A
	VW11055 SALINCAK VE DENGE KOLU BURCU İÇ SOL VE SAĞ	Yön : İç Sol Ve Sağ Ağırlık : 0.121 kg / 0.267 lb	1K0407183E, 8J0407183
	VW12066 TORSİYON BURCU SOL VE SAĞ	Yön : Sol Ve Sağ Ağırlık : 0.6 kg / 1.323 lb	1J0 501 541 D, 1J0501541D
	VW12015 VİRAJ DEMİR LASTİĞİ SOL VE SAĞ RUBBER	Şasi (Ön / Arka) : ÖN Yön : Sol Ve Sağ Ağırlık : 0.03 kg / 0.066 lb Malzeme Türü : Rubber Not : VİRAJ DEMİR LASTİĞİ	6Q0411303H, 6Q0411314E 6Q0411314N, 6Q0411314R
	VW12015K VİRAJ DEMİR LASTİĞİ SOL VE SAĞ RUBBER	Şasi (Ön / Arka) : ÖN Yön : Sol Ve Sağ Ağırlık : 0.06 kg / 0.132 lb Malzeme Türü : Rubber Not : VİRAJ LASTİĞİ (İKİLİ)	6Q0411303H*, 6Q0411303H 6Q0411314E*, 6Q0411314E 6Q0411314N*, 6Q0411314N 6Q0411314R*, 6Q0411314R











* Bu sayfada ve katalogdaki tüm araçların adları, markaları, modelleri, sembolleri, logoları, orjinal numaraları (oe) ve diğer üçüncü parti numaraları sadece referans amaçlı kullanılmaktadır.

POLO
IV 9N
2001 - 2009

Resim	Ürün Kodu ve Açıklaması	Detay	OEM
	VW12024 VİRAJ DEMİR LASTİĞİ SOL VE SAĞ RUBBER	Şasi (Ön / Arka) : ÖN Yön : Sol Ve Sağ Ağırlık : 0.03 kg / 0.066 lb Malzeme Türü : Rubber Not : VİRAJ LASTİĞİ	6Q0411303AA, 6Q0411303AD 6Q0411305H, 6Q0411314M 6Q0411314Q
	VW12024K VİRAJ DEMİR LASTİĞİ SOL VE SAĞ RUBBER	Şasi (Ön / Arka) : ÖN Yön : Sol Ve Sağ Ağırlık : 0.06 kg / 0.132 lb Malzeme Türü : Rubber Not : VİRAJ LASTİĞİ (İKİLİ)	6Q0411303AA*, 6Q0411303AA 6Q0411303AD*, 6Q0411303AD 6Q0411305H*, 6Q0411305H 6Q0411314M*, 6Q0411314M 6Q0411314Q*, 6Q0411314Q
	VW12049 VİRAJ DEMİR LASTİĞİ SOL VE SAĞ RUBBER	Şasi (Ön / Arka) : ÖN Yön : Sol Ve Sağ Ağırlık : 0.03 kg / 0.066 lb Malzeme Türü : Rubber Not : VİRAJ LASTİĞİ	8Z0411314B
	VW12049K VİRAJ DEMİR LASTİĞİ SOL VE SAĞ RUBBER	Şasi (Ön / Arka) : ÖN Yön : Sol Ve Sağ Ağırlık : 0.06 kg / 0.132 lb Malzeme Türü : Rubber	8Z0411314B*
	VW12050 VİRAJ DEMİR LASTİĞİ SOL VE SAĞ RUBBER	Şasi (Ön / Arka) : ÖN Yön : Sol Ve Sağ Ağırlık : 0.04 kg / 0.088 lb Malzeme Türü : Rubber Not : VİRAJ LASTİĞİ	6Q0411314P
	VW12050K VİRAJ DEMİR LASTİĞİ SOL VE SAĞ RUBBER	Şasi (Ön / Arka) : ÖN Yön : Sol Ve Sağ Ağırlık : 0.08 kg / 0.176 lb Malzeme Türü : Rubber Not : VİRAJ LASTİĞİ (İKİLİ)	6Q0411314P*, 6Q0411314P
	VW12062 VİRAJ DEMİR LASTİĞİ SOL VE SAĞ RUBBER	Şasi (Ön / Arka) : ÖN Yön : Sol Ve Sağ Ağırlık : 0.03 kg / 0.066 lb Malzeme Türü : Rubber Not : VİRAJ LASTİĞİ ÖN	6Q0411314F
	VW12062K VİRAJ DEMİR LASTİĞİ SOL VE SAĞ RUBBER	Şasi (Ön / Arka) : ÖN Yön : Sol Ve Sağ Ağırlık : 0.06 kg / 0.132 lb Malzeme Türü : Rubber	6Q0411314F*
	SK12002 AMORTİSÖR TAKOZU ARKA SOL VE SAĞ 1.2 / 1.4TSI / 1.6TDI / 1.2TDI	Şasi (Ön / Arka) : ARKA Yön : Sol Ve Sağ Ağırlık : 0.305 kg / 0.672 lb Not : 1.2 / 1.4TSI / 1.6TDI / 1.2TDI	1J0513353A, 1J0513353B 1J0513353C, 1J0513353G 6QE513353, 6R0513353 6R0513353B
	VW12109 AMORTİSÖR TAKOZU SOL VE SAĞ AMORTİSÖR RULMANI	Yön : Sol Ve Sağ Ağırlık : 0.26 kg / 0.573 lb Not : AMORTİSÖR RULMANI	6N0412249C, 6N0412249E
	VW12109K AMORTİSÖR TAKOZU SOL VE SAĞ 2 PCS	Yön : Sol Ve Sağ Ağırlık : 0.52 kg / 1.146 lb Not : 2 PCS	6N0412249C, 6N0412249E





* Bu sayfada ve katalogdaki tüm araçların adları, markaları, modelleri, sembolleri, logoları, orijinal numaraları (oe) ve diğer üçüncü parti numaraları sadece referans amaçlı kullanılmaktadır.

POLO
IV 9N
2001 - 2009





Resim	Ürün Kodu ve Açıklaması	Detay	OEM
	VW12115 AMORTİSÖR TAKOZU SOL VE SAĞ AMORTİSÖR TAKOZU	Yön : Sol Ve Sağ Ağırlık : 0.85 kg / 1.874 lb Not : AMORTİSÖR TAKOZU	6N0412331D, 6N0412331E 6Q0412331B
	VW12801 AMORTİSÖR TAKOZU SOL VE SAĞ KIT = VW12115 AND VW12109	Yön : Sol Ve Sağ Ağırlık : 1.269 kg / 2.798 lb Not : KIT = VW12115 and VW12109	6N0412249C, 6N0412249E 6N0412331D, 6N0412331E 6Q0412331B
	SE12005 MOTOR TAKOZU ARKA	Şasi (Ön / Arka) : ARKA Ağırlık : 1,115 kg / 2.458 lb	6Q0199851AS, 6Q0199851T
	VW12028 MOTOR TAKOZU SOL VE SAĞ MOTOR TAKOZU	Yön : Sol Ve Sağ Ağırlık : 1.1 kg / 2.425 lb Not : MOTOR TAKOZU	6Q0199851, 6Q0199851AK
	VW12069 MOTOR TAKOZU SOL VE SAĞ MOTOR TAKOZU	Yön : Sol Ve Sağ Ağırlık : 0.83 kg / 1.830 lb Not : MOTOR TAKOZU	6Q0199851AB, 6Q0199851AK
	VW12080 MOTOR TAKOZU SOL VE SAĞ MOTOR TAKOZU	Yön : Sol Ve Sağ Ağırlık : 2.02 kg / 4.453 lb Not : MOTOR TAKOZU	6Q0199167AQ, 6Q0199167BM 6Q0199167BQ, 6Q0199167BR 6Q0199167CA, 6Q0199167CB 6Q0199167CC, 6Q0199167CE 6Q0199167CJ, 6Q0199167CR
	VW12083 MOTOR TAKOZU SOL VE SAĞ MOTOR TAKOZU	Yön : Sol Ve Sağ Ağırlık : 1.95 kg / 4.299 lb Not : MOTOR TAKOZU	6Q0199167BC, 6Q0199167BN 6Q0199167CH, 6Q0199167CL 6Q0199167DA, 6Q0199167DB 6Q0199167DL, 6Q0199167DM 6R0199167AA
	VW12093 MOTOR TAKOZU SOL VE SAĞ MOTOR TAKOZU	Yön : Sol Ve Sağ Ağırlık : 1.05 kg / 2.315 lb Not : MOTOR TAKOZU	6Q0199851AC, 6Q0199851AL 6Q0199851AR, 6Q0199851E 6Q0199851S
	VW12036 SÜSPANSİYON TAKOZU SOL VE SAĞ ARKA SÜSPANSİYON TAKOZU	Yön : Sol Ve Sağ Ağırlık : 1.591 kg / 3.508 lb Not : ARKA SÜSPANSİYON TAKOZU	6Q0512131B
	VW12101 SÜSPANSİYON TAKOZU SOL VE SAĞ SÜSPANSİYON TAKOZU	Yön : Sol Ve Sağ Ağırlık : 0.07 kg / 0.154 lb Not : SÜSPANSİYON TAKOZU	6Q0512131C
	SK12006 EGZOZ TAKOZU	Ağırlık : 0,185 kg / 0.408 lb	6Q0253144B, 6Q0253144D

* Bu sayfada ve katalogdaki tüm araçların adları, markaları, modelleri, sembolleri, logoları, orjinal numaraları (oe) ve diğer üçüncü parti numaraları sadece referans amaçlı kullanılmaktadır.

POLO IV 9N 2001 - 2009











Resim	Ürün Kodu ve Açıklaması	Detay	OEM
	AU14001 AKS KÖRÜĞÜ +KELEPÇE+YAĞ.	Ağırlık : 0.233 kg / 0.514 lb	6Q0498203A
	FI14014 AKS KÖRÜĞÜ +KELEPÇE+YAĞ. DIŞ	Ağırlık : 0.211 kg / 0.465 lb	46307841
	VW14009 AKS KÖRÜĞÜ +KELEPÇE+YAĞ. DIŞ	Ağırlık : 0.16 kg / 0.353 lb	1H0407285B
	AU15001 AMORTİSÖR KÖRÜĞÜ ÖN	Şasi (Ön / Arka) : ÖN Ağırlık : 0,110 kg / 0.243 lb	6N0413175A
	VW15002 AMORTİSÖR KÖRÜĞÜ ARKA	Şasi (Ön / Arka) : ARKA	900064

POLO V 6R 2009 - 2017

Resim	Ürün Kodu ve Açıklaması	Detay	OEM
	SK1025 ROTİL SAĞ	Ağırlık : 0,59 kg / 1.301 lb Konik Ölçüsü : Ø15 Bağlantı Delik Çapı : Ø10,5 Aşık Diş Çapı : M12X1,5	5U0407366A, 6R0407366 6R0407366A, 6R0407366B
	SK1026 ROTİL ÖN ALT SOL Ø15	Ağırlık : 0,59 kg / 1.301 lb Konik Ölçüsü : Ø15 Bağlantı Delik Çapı : Ø10,5 Aşık Diş Çapı : M12X1,5	5U0407365A, 6R0407365 6R0407365A, 6R0407365B
	SK2003 ROTBAŞI SAĞ RC7314	Ağırlık : 0,377 kg / 0.831 lb Uzunluk : 93,5 mm / 3.68 inch Gövde Diş Çapı : M14X1,5 Aşık Diş Çapı : M12X1,5 Aşık Konik Çapı : Ø13,5	5Z0423812, 6Q0419812C 6Q0423812, 6Q0423812A 6Q0423812C, 6Q0423812D 6R0423812, 8Z0423811A
	SK2004 ROTBAŞI SOL RC7313	Ağırlık : 0,382 kg / 0.842 lb Uzunluk : 93 mm / 3.66 inch Gövde Diş Çapı : M14X1,5 Aşık Diş Çapı : M12X1,5 Aşık Konik Çapı : Ø13,5	5Z0423811, 6Q0419811C 6Q0423811, 6Q0423811A 6Q0423811C, 6Q0423811D 6R0423811, 8Z0423812A
	SK2006 ROTBAŞI SAĞ	Ağırlık : 0,420 kg / 0.926 lb Uzunluk : 94 mm / 3.70 inch Gövde Diş Çapı : M14X1,5 Aşık Diş Çapı : M12X1,5 Aşık Konik Çapı : Ø13,3	6C0423812A

* Bu sayfada ve katalogdaki tüm araçların adları, markaları, modelleri, sembolleri, logoları, orjinal numaraları (oe) ve diğer üçüncü parti numaraları sadece referans amaçlı kullanılmaktadır.

POLO
V 6R
2009 - 2017

Resim	Ürün Kodu ve Açıklaması	Detay	OEM
	SK2007 ROTBAŞI SOL	Ağırlık : 0,420 kg / 0.926 lb Uzunluk : 94 mm / 3.70 inch Gövde Diş Çapı : M14X1,5 Aşık Diş Çapı : M12X1,5 Aşık Konik Çapı : Ø13,3	6C0423811A
	AU3012 ROTMİLİ SAĞ-SOL M14X1,5 L=312MM	Ağırlık : 0,6 kg / 1.323 lb Uzunluk : 312 mm / 12.28 inch Gövde Diş Çapı : M14X1,5 Aşık Diş Çapı : M14X1,5	6C0423810A, 6C0423810B 6C0423810C
	VW3017 ROTMİLİ ÖN M14X1.5 313	Ağırlık : 0,6 kg / 1.323 lb Uzunluk : 313 mm / 12.32 inch Gövde Diş Çapı : M14X1,5 Aşık Diş Çapı : M14X1,5	6R0423803, 6R0423803C 6R0423804, 6R0423804B 6R0423804C, 6R0423810 8Z0419810C, 8Z0423803
	VW3023 ROTMİLİ SAĞ-SOL L=331 MM	Uzunluk : 331 mm / 13.03 inch	6RD423810, 6RU423810
	SK2003VW3017 ROT TAKIMI ÖN AKS SAĞ	Ağırlık : 1,008 kg / 2.222 lb Rotbaşı : SK2003 Rotmilî : VW3017	6R0423804, 6R0423804A 8Z0423804C
	SK2004VW3017 ROT TAKIMI ÖN AKS SOL	Ağırlık : 1,008 kg / 2.222 lb Rotbaşı : SK2004 Rotmilî : VW3017	6R0423803, 6R0423803A 8Z0423803C, SK-402923
	AU4028 Z ROT ÖN	Ağırlık : 0,368 kg / 0.811 lb Malzeme Türü : Metal Uzunluk : 270 mm / 10.63 inch Aşık Diş Çapı : M10X1,5	6Q0411315L, 6Q0411315N 8Z0411315D
	SK4001 Z ROT ÖN METAL	Ağırlık : 0,357 kg / 0.787 lb Malzeme Türü : Metal Uzunluk : 270 mm / 10.63 inch Aşık Diş Çapı : M10X1,5	2Q0411315, 2Q0411315A 6Q0411315A, 6Q0411315E 6Q0411315F, 6Q0411315H 6Q0411315J, 6Q0411315M 6Q0411315P
	VW6034 SALINCAK ÖN SAĞ	Ağırlık : 3,495 kg / 7.705 lb Malzeme Türü : Sac Metal	6R0407152A**, 6R0407152A 6R0407152B**, 6R0407152C** 6R0407152C, 6R0407152E 6R0407152F**
	VW6034J SALINCAK ÖN SAĞ	Ağırlık : 3 kg / 6.614 lb Malzeme Türü : Sac Metal	6R0407152A, 6R0407152B 6R0407152C, 6R0407152F
	VW6035 SALINCAK ÖN SOL	Ağırlık : 3,495 kg / 7.705 lb Malzeme Türü : Sac Metal	6R0407151A**, 6R0407151A 6R0407151B**, 6R0407151C** 6R0407151C, 6R0407151E 6R0407151F**











* Bu sayfada ve katalogdaki tüm araçların adları, markaları, modelleri, sembolleri, logoları, orjinal numaraları (oe) ve diğer üçüncü parti numaraları sadece referans amaçlı kullanılmaktadır.

POLO
V 6R
2009 - 2017

Resim	Ürün Kodu ve Açıklaması	Detay	OEM
	VW6035J SALINCAK ÖN SOL	Ağırlık : 3,5 kg / 7.716 lb Malzeme Türü : Sac Metal	6R0407151A, 6R0407151B 6R0407151C, 6R0407151F
	AU11002 SALINCAK VE DENGE KOLU BURCU ÖN SOL VE SAĞ B22117	Şasi (Ön / Arka) : ÖN Yön : Sol Ve Sağ Ağırlık : 0,108 kg / 0.238 lb	1J0407181, 1J0407181A
	AU11005 SALINCAK VE DENGE KOLU BURCU ÖN ORTA SOL VE SAĞ B40115	Şasi (Ön / Arka) : ÖN Yön : Orta Sol Ve Sağ Ağırlık : 0,111 kg / 0.245 lb Not : VW6014 - VW60614J	191407182, 357407182 357407182F
	VW12015 VİRAJ DEMİR LASTİĞİ SOL VE SAĞ RUBBER	Şasi (Ön / Arka) : ÖN Yön : Sol Ve Sağ Ağırlık : 0.03 kg / 0.066 lb Malzeme Türü : Rubber Not : VİRAJ DEMİR LASTİĞİ	6Q0411303H, 6Q0411314E 6Q0411314N, 6Q0411314R
	VW12015K VİRAJ DEMİR LASTİĞİ SOL VE SAĞ RUBBER	Şasi (Ön / Arka) : ÖN Yön : Sol Ve Sağ Ağırlık : 0.06 kg / 0.132 lb Malzeme Türü : Rubber Not : VİRAJ LASTİĞİ (İKİLİ)	6Q0411303H*, 6Q0411303H 6Q0411314E*, 6Q0411314E 6Q0411314N*, 6Q0411314N 6Q0411314R*, 6Q0411314R
	VW12024 VİRAJ DEMİR LASTİĞİ SOL VE SAĞ RUBBER	Şasi (Ön / Arka) : ÖN Yön : Sol Ve Sağ Ağırlık : 0.03 kg / 0.066 lb Malzeme Türü : Rubber Not : VİRAJ LASTİĞİ	6Q0411303AA, 6Q0411303AD 6Q0411305H, 6Q0411314M 6Q0411314Q
	VW12024K VİRAJ DEMİR LASTİĞİ SOL VE SAĞ RUBBER	Şasi (Ön / Arka) : ÖN Yön : Sol Ve Sağ Ağırlık : 0.06 kg / 0.132 lb Malzeme Türü : Rubber Not : VİRAJ LASTİĞİ (İKİLİ)	6Q0411303AA*, 6Q0411303AA 6Q0411303AD*, 6Q0411303AD 6Q0411305H*, 6Q0411305H 6Q0411314M*, 6Q0411314M 6Q0411314Q*, 6Q0411314Q
	SK12002 AMORTİSÖR TAKOZU ARKA SOL VE SAĞ 1.2 / 1.4TSI / 1.6TDI / 1.2TDI	Şasi (Ön / Arka) : ARKA Yön : Sol Ve Sağ Ağırlık : 0,305 kg / 0.672 lb Not : 1.2 / 1.4TSI / 1.6TDI / 1.2TDI	1J0513353A, 1J0513353B 1J0513353C, 1J0513353G 6QE513353, 6R0513353 6R0513353B
	VW12061 AMORTİSÖR TAKOZU SOL VE SAĞ AMORTİSÖR TAKOZU	Yön : Sol Ve Sağ Ağırlık : 0.27 kg / 0.595 lb Not : AMORTİSÖR TAKOZU	1H0412365A, 1J0412249 1J0412331BS, 1J0412331C
	VW12061A AMORTİSÖR TAKOZU SOL VE SAĞ AMORTİSÖR RULMANI	Yön : Sol Ve Sağ Ağırlık : 0.08 kg / 0.176 lb Not : AMORTİSÖR RULMANI	1J0412249, 1J0412249C 357412249, 357412249A 4503300051, 7201688 7201848, 95VW3K031AA
	VW12061K AMORTİSÖR TAKOZU SOL VE SAĞ 2 PCS	Yön : Sol Ve Sağ Ağırlık : 0.7 kg / 1.543 lb Not : 2 PCS	1H0412365A, 1J0412249 1J0412331BS, 1J0412331C





* Bu sayfada ve katalogdaki tüm araçların adları, markaları, modelleri, sembolleri, logoları, orijinal numaraları (oe) ve diğer üçüncü parti numaraları sadece referans amaçlı kullanılmaktadır.

POLO
V 6R
2009 - 2017

Resim	Ürün Kodu ve Açıklaması	Detay	OEM
	VW12103 AMORTİSÖR TAKOZU SOL VE SAĞ AMORTİSÖR ÜST TAKOZU	Yön : Sol Ve Sağ Ağırlık : 0.23 kg / 0.507 lb Not : AMORTİSÖR ÜST TAKOZU	1J0412331B, 1J0412331C
	SE12001 MOTOR TAKOZU ÖN SOL VE SAĞ	Şasi (Ön / Arka) : ÖN Yön : Sol Ve Sağ Ağırlık : 1,360 kg / 2.998 lb	6C0199851J
	SE12002 MOTOR TAKOZU ÖN SOL VE SAĞ	Şasi (Ön / Arka) : ÖN Yön : Sol Ve Sağ Ağırlık : 1,100 kg / 2.425 lb	6C0199851
	SE12003 MOTOR TAKOZU ÖN SOL VE SAĞ	Şasi (Ön / Arka) : ÖN Yön : Sol Ve Sağ Ağırlık : 1,900 kg / 4.189 lb	6C0199167B
	SE12004 MOTOR TAKOZU ÖN SOL VE SAĞ	Şasi (Ön / Arka) : ÖN Yön : Sol Ve Sağ Ağırlık : 1,300 kg / 2.866 lb	6C0199262A
	VW12028 MOTOR TAKOZU SOL VE SAĞ MOTOR TAKOZU	Yön : Sol Ve Sağ Ağırlık : 1.1 kg / 2.425 lb Not : MOTOR TAKOZU	6Q0199851, 6Q0199851AK
	VW12069 MOTOR TAKOZU SOL VE SAĞ MOTOR TAKOZU	Yön : Sol Ve Sağ Ağırlık : 0.83 kg / 1.830 lb Not : MOTOR TAKOZU	6Q0199851AB, 6Q0199851AK
	VW12093 MOTOR TAKOZU SOL VE SAĞ MOTOR TAKOZU	Yön : Sol Ve Sağ Ağırlık : 1.05 kg / 2.315 lb Not : MOTOR TAKOZU	6Q0199851AC, 6Q0199851AL 6Q0199851AR, 6Q0199851E 6Q0199851S
	VW12123 MOTOR TAKOZU SOL ŞANZUMAN TAKOZU	Yön : Sol Ağırlık : 1.642 kg / 3.620 lb Malzeme Türü : Şanzuman TakoZu	6Q0199555AE, 6Q0199555AT 6R0199555, 6RF199555A 6RF199555C
	VW12036 SÜSPANSİYON TAKOZU SOL VE SAĞ ARKA SÜSPANSİYON TAKOZU	Yön : Sol Ve Sağ Ağırlık : 1.591 kg / 3.508 lb Not : ARKA SÜSPANSİYON TAKOZU	6Q0512131B
	VW12101 SÜSPANSİYON TAKOZU SOL VE SAĞ SÜSPANSİYON TAKOZU	Yön : Sol Ve Sağ Ağırlık : 0.07 kg / 0.154 lb Not : SÜSPANSİYON TAKOZU	6Q0512131C

* Bu sayfada ve katalogdaki tüm araçların adları, markaları, modelleri, sembolleri, logoları, orjinal numaraları (oe) ve diğer üçüncü parti numaraları sadece referans amaçlı kullanılmaktadır.

POLO
V 6R
2009 - 2017











Resim	Ürün Kodu ve Açıklaması	Detay	OEM
	SK12006 EGZOZ TAKOZU	Ağırlık : 0,185 kg / 0.408 lb	6Q0253144B, 6Q0253144D
	VW12086 RADYATÖR TAKOZU SOL VE SAĞ RADYATÖR ÜST LASTİĞİ	Yön : Sol Ve Sağ Ağırlık : 0.024 kg / 0.053 lb Not : RADYATÖR ÜST LASTİĞİ	1K0121367F
	AU14001 AKS KÖRÜĞÜ +KELEPÇE+YAĞ.	Ağırlık : 0.233 kg / 0.514 lb	6Q0498203A
	VW14003 AKS KÖRÜĞÜ +KELEPÇE+YAĞ. DIŞ	Ağırlık : 0.25 kg / 0.551 lb	1K0 498 203, 1K0498203

POLO
VI
2017 -

Resim	Ürün Kodu ve Açıklaması	Detay	OEM
	VW1014 ROTİL ÖN ALT SAĞ Ø15,6 RB2536	Ağırlık : 0,565 kg / 1.246 lb Konik Ölçüsü : Ø15,6 Bağlantı Delik Çapı : Ø10,5 Aşık Diş Çapı : M12X1,5	1K0407366B, 1K0407366C 1K0407366E, 5Q0407366A
	VW1015 ROTİL ÖN ALT SOL Ø15,6 RB2537	Ağırlık : 0,565 kg / 1.246 lb Konik Ölçüsü : Ø15,6 Bağlantı Delik Çapı : Ø10,5 Aşık Diş Çapı : M12X1,5	1K0407365B, 1K0407365C 1K0407365E, 5Q0407365A
	SE2008 ROTBAŞI SAĞ	Ağırlık : 0,426 kg / 0.939 lb Uzunluk : 95 mm / 3.74 inch Gövde Diş Çapı : M16X1,5 Aşık Diş Çapı : M12X1,5 Aşık Konik Çapı : Ø13,3	2Q0423812, 2QB423812
	SE2009 ROTBAŞI SOL	Ağırlık : 0,426 kg / 0.939 lb Uzunluk : 95 mm / 3.74 inch Gövde Diş Çapı : M16X1,5 Aşık Diş Çapı : M12X1,5 Aşık Konik Çapı : Ø13,3	2Q0423811, 2QB423811
	VW3025 ROTMİLİ SOL VE SAĞ 311	Ağırlık : 0,676 kg / 1.490 lb Uzunluk : 311 mm / 12.24 inch Gövde Diş Çapı : M14X1,5 Aşık Diş Çapı : M16X1,5	2Q0423810D
	SK4001 Z ROT ÖN METAL	Ağırlık : 0,357 kg / 0.787 lb Malzeme Türü : Metal Uzunluk : 270 mm / 10.63 inch Aşık Diş Çapı : M10X1,5	2Q0411315, 2Q0411315A 6Q0411315A, 6Q0411315E 6Q0411315F, 6Q0411315H 6Q0411315J, 6Q0411315M 6Q0411315P

* Bu sayfada ve katalogdaki tüm araçların adları, markaları, modelleri, sembolleri, logoları, orjinal numaraları (oe) ve diğer üçüncü parti numaraları sadece referans amaçlı kullanılmaktadır.

POLO
VI
2017 -

Resim	Ürün Kodu ve Açıklaması	Detay	OEM
	VW6063 SALINCAK ÖN ALT SAĞ	Ağırlık : 3,004 kg / 6.623 lb Malzeme Türü : Sac Metal	2Q0407152B
	VW6063J SALINCAK ÖN ALT SAĞ	Ağırlık : 2,439 kg / 5.377 lb Malzeme Türü : Sac Metal	2Q0407152B
	VW6064 SALINCAK ÖN ALT SOL	Ağırlık : 3,004 kg / 6.623 lb Malzeme Türü : Sac Metal	2Q0407151B
	VW6064J SALINCAK ÖN ALT SOL	Ağırlık : 2,439 kg / 5.377 lb Malzeme Türü : Sac Metal	2Q0407151B
	VW6065 SALINCAK ÖN ALT SAĞ	Ağırlık : 3,57 kg / 7.871 lb Malzeme Türü : Sac Metal	2Q0407152C
	VW6065J SALINCAK ÖN ALT SAĞ	Ağırlık : 2,964 kg / 6.535 lb Malzeme Türü : Sac Metal	2Q0407152C
	VW6066 SALINCAK ÖN ALT SOL	Ağırlık : 3,57 kg / 7.871 lb Malzeme Türü : Sac Metal	2Q0407151C
	VW6066J SALINCAK ÖN ALT SOL	Ağırlık : 2,964 kg / 6.535 lb Malzeme Türü : Sac Metal	2Q0407151C
	AU11005 SALINCAK VE DENGE KOLU BURCU ÖN ORTA SOL VE SAĞ B40115	Şasi (Ön / Arka) : ÖN Yön : Orta Sol Ve Sağ Ağırlık : 0,111 kg / 0.245 lb Not : VW6014 - VW60614J	191407182, 357407182 357407182F
	AU12027 AMORTİSÖR TAKOZU ARKA ÜST SAĞ	Şasi (Ön / Arka) : ARKA Yön : Üst Sağ Ağırlık : 0,415 kg / 0.915 lb	5Q0513353H
	SE12003 MOTOR TAKOZU ÖN SOL VE SAĞ	Şasi (Ön / Arka) : ÖN Yön : Sol Ve Sağ Ağırlık : 1,900 kg / 4.189 lb	6C0199167B

* Bu sayfada ve katalogdaki tüm araçların adları, markaları, modelleri, sembolleri, logoları, orjinal numaraları (oe) ve diğer üçüncü parti numaraları sadece referans amaçlı kullanılmaktadır.

POLO CLASSIC
6KV2
1995 - 2001

Resim	Ürün Kodu ve Açıklaması	Detay	OEM
	VW1011 ROTİL D= Ø17	Ağırlık : 0,39 kg / 0.860 lb Bağlantı Delik Çapı : Ø8,5	191407365, 191407365B
	VW1011K ROTİL ALT SAĞ-SOL Ø17 RD0514	Ağırlık : 0,435 kg / 0.959 lb Bağlantı Delik Çapı : Ø8,5	191.407.365F, 191407365 191407365B*, 191407365F
	VW1012 ROTİL ALT SOL VE SAĞ	Ağırlık : 0,353 kg / 0.778 lb Bağlantı Delik Çapı : Ø8,5	357407365, 357407365A
	VW1012K ROTİL ALT SAĞ-SOL 19 RD0515	Ağırlık : 0,445 kg / 0.981 lb Bağlantı Delik Çapı : Ø8,5	357407365, 357407365A* 357407365A, 357407365S 357407365-S1
	VW2006 ROTBAŞI SAĞ RD0312	Ağırlık : 0,3 kg / 0.661 lb Uzunluk : 76 mm / 2.99 inch Gövde Diş Çapı : M14X1,5 Aşık Diş Çapı : M12X1,5 Aşık Konik Çapı : Ø12,7	191419812, 22190091617 6N0419812, 6N0422812 XA2087
	VW2007 ROTBAŞI SOL RD0311	Ağırlık : 0,3 kg / 0.661 lb Uzunluk : 76 mm / 2.99 inch Gövde Diş Çapı : M14X1,5 Aşık Diş Çapı : M12X1,5 Aşık Konik Çapı : Ø12,7	191419811, 22190090617 6N0419811, 6N0422811 XA2084
	VW3004 ROTMİLİ ÖN SAĞ - SOL 338 RD0887	Ağırlık : 0,605 kg / 1.334 lb Uzunluk : 338 mm / 13.31 inch Gövde Diş Çapı : M14X1,5 Aşık Diş Çapı : M14X1,5	191407153, 191422721 191422803A, 191422804A 191422807, 191422807A 191422821, 191422821A 6K0422821
	VW4022 Z ROT ÖN SAĞ-SOL 18MM 75 RD0931	Ağırlık : 0,166 kg / 0.366 lb Malzeme Türü : Metal Uzunluk : 76 mm / 2.99 inch Aşık Diş Çapı : M8X1,25	6N0411315A, 6N0411315D
	VW4025 Z ROT ÖN SAĞ-SOL 15MM 75 RD0925	Ağırlık : 0,173 kg / 0.381 lb Uzunluk : 30 mm / 1.18 inch	6N0411315
	VW6004 SALINCAK ÖN SAĞ	Ağırlık : 3,21 kg / 7.077 lb Malzeme Türü : Sac Metal	191407151A
	VW60046005K SALINCAK ÖN	Ağırlık : 3.8 kg / 8.378 lb Malzeme Türü : Sac Metal	

* Bu sayfada ve katalogdaki tüm araçların adları, markaları, modelleri, sembolleri, logoları, orjinal numaraları (oe) ve diğer üçüncü parti numaraları sadece referans amaçlı kullanılmaktadır.

POLO CLASSIC
6KV2
1995 - 2001

Resim	Ürün Kodu ve Açıklaması	Detay	OEM
	VW6004J SALINCAK ÖN RD1103	Ağırlık : 2,605 kg / 5.743 lb Malzeme Türü : Sac Metal	191.407.151B, 191407151A 191407151B
	VW6005 SALINCAK ÖN SOL	Ağırlık : 3,21 kg / 7.077 lb Malzeme Türü : Sac Metal	192407151A
	VW6006 SALINCAK ÖN SAĞ RD1019	Ağırlık : 3,166 kg / 6.980 lb Malzeme Türü : Sac Metal	191407151B, 191407175 191411315B, 191411331 357407365A, 6N0411329 N0111849, N10127702
	VW60066007K SALINCAK ÖN	Ağırlık : 3.3 kg / 7.275 lb Malzeme Türü : Sac Metal	
	VW600674008K SALINCAK ÖN	Ağırlık : 3.466 kg / 7.641 lb Malzeme Türü : Sac Metal	
	VW6007 SALINCAK ÖN SOL RD1029	Ağırlık : 3,088 kg / 6.808 lb Malzeme Türü : Sac Metal	191407151A
	AU11005 SALINCAK VE DENGE KOLU BURCU ÖN ORTA SOL VE SAĞ B40115	Şasi (Ön / Arka) : ÖN Yön : Orta Sol Ve Sağ Ağırlık : 0,111 kg / 0.245 lb Not : VW6014 - VW60614J	191407182, 357407182 357407182F
	VW11001 SALINCAK VE DENGE KOLU BURCU SOL VE SAĞ B40114	Yön : Sol Ve Sağ Ağırlık : 0.141 kg / 0.311 lb	191407181D, 191407181E 357407181
	VW12037 VİRAJ DEMİR LASTİĞİ SOL VE SAĞ RUBBER	Şasi (Ön / Arka) : ÖN Yön : Sol Ve Sağ Ağırlık : 0.11 kg / 0.243 lb Malzeme Türü : Rubber Not : VİRAJ DEMİR LASTİĞİ ÖN	191411314
	VW12037K VİRAJ DEMİR LASTİĞİ SOL VE SAĞ RUBBER	Şasi (Ön / Arka) : ÖN Yön : Sol Ve Sağ Ağırlık : 0.22 kg / 0.485 lb Malzeme Türü : Rubber	191411314*
	VW12111 VİRAJ DEMİR LASTİĞİ SOL VE SAĞ RUBBER	Şasi (Ön / Arka) : ÖN Yön : Sol Ve Sağ Ağırlık : 0.015 kg / 0.033 lb Malzeme Türü : Rubber Not : VİRAJ LASTİĞİ	191411329, 6N0411329





* Bu sayfada ve katalogdaki tüm araçların adları, markaları, modelleri, sembolleri, logoları, orijinal numaraları (oe) ve diğer üçüncü parti numaraları sadece referans amaçlı kullanılmaktadır.

POLO CLASSIC
6KV2
1995 - 2001





Resim	Ürün Kodu ve Açıklaması	Detay	OEM
	VW12111K VİRAJ DEMİR LASTİĞİ SOL VE SAĞ RUBBER	Şasi (Ön / Arka) : ÖN Yön : Sol Ve Sağ Ağırlık : 0.03 kg / 0.066 lb Malzeme Türü : Rubber	191411329*, 6N0411329*
	VW12005 AMORTİSÖR TAKOZU SOL VE SAĞ AMORTİSÖR ÜST TAKOZU	Yön : Sol Ve Sağ Ağırlık : 0.1 kg / 0.220 lb Not : AMORTİSÖR ÜST TAKOZU	191512333
	VW12109 AMORTİSÖR TAKOZU SOL VE SAĞ AMORTİSÖR RULMANI	Yön : Sol Ve Sağ Ağırlık : 0.26 kg / 0.573 lb Not : AMORTİSÖR RULMANI	6N0412249C, 6N0412249E
	VW12109K AMORTİSÖR TAKOZU SOL VE SAĞ 2 PCS	Yön : Sol Ve Sağ Ağırlık : 0.52 kg / 1.146 lb Not : 2 PCS	6N0412249C, 6N0412249E
	VW12115 AMORTİSÖR TAKOZU SOL VE SAĞ AMORTİSÖR TAKOZU	Yön : Sol Ve Sağ Ağırlık : 0.85 kg / 1.874 lb Not : AMORTİSÖR TAKOZU	6N0412331D, 6N0412331E 6Q0412331B
	VW12801 AMORTİSÖR TAKOZU SOL VE SAĞ KIT = VW12115 AND VW12109	Yön : Sol Ve Sağ Ağırlık : 1.269 kg / 2.798 lb Not : KIT = VW12115 and VW12109	6N0412249C, 6N0412249E 6N0412331D, 6N0412331E 6Q0412331B
	VW12008 MOTOR TAKOZU SOL VE SAĞ MOTOR TAKOZU	Yön : Sol Ve Sağ Ağırlık : 0.574 kg / 1.265 lb Not : MOTOR TAKOZU	357199381C, 357199402B 3A0199402
	VW12074 MOTOR TAKOZU SOL VE SAĞ MOTOR TAKOZU	Yön : Sol Ve Sağ Ağırlık : 1.08 kg / 2.381 lb Not : MOTOR TAKOZU	1H0199609B, 1H0199609F 1H0199609G, 1H0199609J
	VW12092 MOTOR TAKOZU SAĞ MOTOR TAKOZU ARKA SAĞ	Yön : Sağ Ağırlık : 1.745 kg / 3.847 lb Not : MOTOR TAKOZU ARKA SAĞ	1H0199262B, 1H0199262G 1H0199262H
	VW12098 MOTOR TAKOZU SOL VE SAĞ MOTOR TAKOZU	Yön : Sol Ve Sağ Ağırlık : 1.565 kg / 3.450 lb Not : MOTOR TAKOZU	1H0199262E
	VW13008 DİREKSİYON KÖRÜĞÜ	Ağırlık : 0.225 kg / 0.496 lb	1H0422831B

* Bu sayfada ve katalogdaki tüm araçların adları, markaları, modelleri, sembolleri, logoları, orjinal numaraları (oe) ve diğer üçüncü parti numaraları sadece referans amaçlı kullanılmaktadır.

POLO CLASSIC
6KV2
1995 - 2001









Resim	Ürün Kodu ve Açıklaması	Detay	OEM
	VW13010 DİREKSİYON KÖRÜĞÜ ÖN	Ağırlık : 0,124 kg / 0.273 lb	191422831
	RN14006 AKS KÖRÜĞÜ +KELEPÇE+YAĞ. DIŞ	Ağırlık : 0.2 kg / 0.441 lb	1603180, 1603204 16410170470106*, 16500170470106* 1H0498203, 271648 271649, 321498203A
	VW14013 AKS KÖRÜĞÜ +KELEPÇE+YAĞ. YAĞ+KELEPÇE	Ağırlık : 0.156 kg / 0.344 lb	113501149, 171407283A
	VW14014 AKS KÖRÜĞÜ +KELEPÇE+YAĞ. YAĞ+KELEPÇE	Ağırlık : 0.28 kg / 0.617 lb	191498203C, 71498203

QUANTUM
1983 - 1988



Resim	Ürün Kodu ve Açıklaması	Detay	OEM
	AU1003 ROTİL ÖN SAĞ RB2515	Ağırlık : 0,58 kg / 1.279 lb Bağlantı Delik Çapı : Ø10,5	855407366A, 855407366B
	AU1004 ROTİL ÖN SOL RB2514	Ağırlık : 0,58 kg / 1.279 lb Bağlantı Delik Çapı : Ø10,5	855407365A, 855407365B
	AU2311 ROTBAŞI ÖN SAĞ - SOL RB2311	Ağırlık : 0,218 kg / 0.481 lb Uzunluk : 75 mm / 2.95 inch Gövde Diş Çapı : M14X1,5 Aşık Diş Çapı : M10X1 Aşık Konik Çapı : Ø11	811419812A, 811419812B 8A0419812
	AU6002J SALINCAK ÖN SAĞ RB3105	Ağırlık : 2,226 kg / 4.907 lb Malzeme Türü : Sac Metal	893407148C
	AU6003J SALINCAK ÖN SOL RB3106	Ağırlık : 2,147 kg / 4.733 lb Malzeme Türü : Sac Metal	893407147C, 893407147E

* Bu sayfada ve katalogdaki tüm araçların adları, markaları, modelleri, sembolleri, logoları, orjinal numaraları (oe) ve diğer üçüncü parti numaraları sadece referans amaçlı kullanılmaktadır.

RABBIT
MK1, A1
1974 - 1984











Resim	Ürün Kodu ve Açıklaması	Detay	OEM
	VW1005 ROTİL ALT SOL VE SAĞ RD0512	Ağırlık : 0,346 kg / 0.763 lb Bağlantı Delik Çapı : Ø7,5	171407365C, 171407365D
	VW1006 ROTİL SAĞ RD0513	Ağırlık : 0,35 kg / 0.772 lb Bağlantı Delik Çapı : Ø7,5	171407365F, 171407365G
	VW2003 ROTBAŞI SAĞ-SOL RD0339	Ağırlık : 0,3 kg / 0.661 lb Uzunluk : 79 mm / 3.11 inch Gövde Diş Çapı : M14X1,5 Aşık Diş Çapı : M12X1,5 Aşık Konik Çapı : Ø12,3	171419811, 171419811A 171419812, 251419811 32111116463, 477419811 477419815, 94434733300
	VW3002 ROTMİLİ RD0811	Ağırlık : 0,665 kg / 1.466 lb Uzunluk : 342 mm / 13.46 inch Gövde Diş Çapı : M22X1,5 Aşık Diş Çapı : M14X1,5	171419821, 171419821A
	VW20033002 ROT TAKIMI SOL VE SAĞ	Ağırlık : 0,963 kg / 2.123 lb Rotbaşı : VW2003 Rotmilî : VW3002	171 419 804, 171419804
	VW6001 SALINCAK ÖN ALT SAĞ	Ağırlık : 3,652 kg / 8.051 lb Malzeme Türü : Sac Metal	171407153D
	VW6001J SALINCAK ÖN ALT	Ağırlık : 2,236 kg / 4.930 lb Malzeme Türü : Sac Metal	171407153D
	VW6002 SALINCAK ÖN ALT SOL RD1047	Ağırlık : 2,668 kg / 5.882 lb Malzeme Türü : Sac Metal	171407153D

RABBIT
MK5, A5
2003 - 2009

Resim	Ürün Kodu ve Açıklaması	Detay	OEM
	VW1014 ROTİL ÖN ALT SAĞ Ø15,6 RB2536	Ağırlık : 0,565 kg / 1.246 lb Konik Ölçüsü : Ø15,6 Bağlantı Delik Çapı : Ø10,5 Aşık Diş Çapı : M12X1,5	1K0407366B, 1K0407366C 1K0407366E, 5Q0407366A
	VW1015 ROTİL ÖN ALT SOL Ø15,6 RB2537	Ağırlık : 0,565 kg / 1.246 lb Konik Ölçüsü : Ø15,6 Bağlantı Delik Çapı : Ø10,5 Aşık Diş Çapı : M12X1,5	1K0407365B, 1K0407365C 1K0407365E, 5Q0407365A

* Bu sayfada ve katalogdaki tüm araçların adları, markaları, modelleri, sembolleri, logoları, orjinal numaraları (oe) ve diğer üçüncü parti numaraları sadece referans amaçlı kullanılmaktadır.

RABBIT
MK5, A5
2003 - 2009

Resim	Ürün Kodu ve Açıklaması	Detay	OEM
	VW2008 ROTBAŞI ÖN SAĞ RD0342	Ağırlık : 0,412 kg / 0.908 lb Uzunluk : 95 mm / 3.74 inch Gövde Diş Çapı : M16X1,5 Aşık Diş Çapı : M12X1,5 Aşık Konik Çapı : Ø12,7	1K0423812A, 1K0423812C 1K0423812E, 1K0423812G 1K0423812J, 1K0423812K 1KD423812A
	VW2009 ROTBAŞI ÖN SOL RD0343	Ağırlık : 0,412 kg / 0.908 lb Uzunluk : 95 mm / 3.74 inch Gövde Diş Çapı : M16X1,5 Aşık Diş Çapı : M12X1,5 Aşık Konik Çapı : Ø13,5	1K0423811A, 1K0423811C 1K0423811E, 1K0423811G 1K0423811J, 1K0423811K 1KD423811A
	VW3009 ROTMİLİ SAĞ-SOL 310 RB2838	Ağırlık : 0,665 kg / 1.466 lb Uzunluk : 311 mm / 12.24 inch Gövde Diş Çapı : M16X1,5 Aşık Diş Çapı : M16X1,5	1K0423810A
	VW20083009 ROT TAKIMI ÖN AKS SAĞ RB288137	Ağırlık : 1,078 kg / 2.377 lb Rotbaşı : VW2008 Rotmilî : VW3009	
	VW20093009 ROT TAKIMI ÖN SOL RB288138	Ağırlık : 1,077 kg / 2.374 lb Rotbaşı : VW2009 Rotmilî : VW3009	
	VW4014 Z ROT ÖN SAĞ-SOL METAL 335 RB2935	Ağırlık : 0,46 kg / 1.014 lb Malzeme Türü : Metal Uzunluk : 335 mm / 13.19 inch Aşık Diş Çapı : M12X1,5	1K0411315B, 1K0411315D 1K0411315J, 1K0411315K 1K0411315R, 5Q0411315A 5Q0411315B
	VW4015 Z ROT SOL VE SAĞ METAL RB2937	Ağırlık : 0,373 kg / 0.822 lb Malzeme Türü : Metal Uzunluk : 95,5 mm / 3.76 inch Aşık Diş Çapı : M10X1,5	1K0505465C, 1K0505465D 1K0505465H, 1K0505465J 1K0505465K
	VW4015K Z ROT SOL VE SAĞ METAL	Ağırlık : 0,373 kg / 0.822 lb Malzeme Türü : Metal Uzunluk : 95,5 mm / 3.76 inch Aşık Diş Çapı : M10X1,5	1K0505465C, 1K0505465D 1K0505465H, 1K0505465J 1K0505465K
	AU6010 SALINCAK ÜST SOL VE SAĞ RA5155	Ağırlık : 1,298 kg / 2.862 lb Malzeme Türü : Sac Metal	1K0505323H, 1K0505323N
	SE9001 SALINCAK ALT SAĞ RA5150	Ağırlık : 1 kg / 2.205 lb Malzeme Türü : Sac Metal	1K0501530C
	SE9002 SALINCAK ALT SOL RA5151	Ağırlık : 1 kg / 2.205 lb Malzeme Türü : Sac Metal	1K0501529F











* Bu sayfada ve katalogdaki tüm araçların adları, markaları, modelleri, sembolleri, logoları, orjinal numaraları (oe) ve diğer üçüncü parti numaraları sadece referans amaçlı kullanılmaktadır.

RABBIT
MK5, A5
2003 - 2009

Resim	Ürün Kodu ve Açıklaması	Detay	OEM
	VW6016 SALINCAK ÖN SAĞ RD10227	Ağırlık : 4,543 kg / 10.016 lb Malzeme Türü : Sac Metal	1K0407152P, 1K0407152Q* 1K0407152Q
	VW6016J SALINCAK ÖN ALT SAĞ S737	Ağırlık : 4,015 kg / 8.852 lb Malzeme Türü : Sac Metal	1K0407151P, 1K0407151Q 1K0407152P, 1K0407152Q
	VW6017 SALINCAK ÖN SOL RD10226	Ağırlık : 4,543 kg / 10.016 lb Malzeme Türü : Sac Metal	1K0407151M*, 1K0407151P 1K0407151Q*, 1K0407151Q
	VW6017J SALINCAK ÖN ALT SOL S738	Ağırlık : 4,015 kg / 8.852 lb Malzeme Türü : Sac Metal	1K0407151P, 1K0407151Q 1K0407152P, 1K0407152Q
	VW6018 SALINCAK ÖN SAĞ RB30219	Ağırlık : 4,85 kg / 10.692 lb Malzeme Türü : Döküm Çelik	1K0407152AC*, 1K0407152M* 1K0407152P, 1K0407152Q 1K0407152R*
	VW6018J SALINCAK ÖN SAĞ RB30211	Ağırlık : 4,232 kg / 9.330 lb Malzeme Türü : Döküm Çelik	1K0407152AC, 1K0407152M 1K0407152R
	VW6019 SALINCAK ÖN SOL RB30218	Ağırlık : 4,85 kg / 10.692 lb Malzeme Türü : Döküm Çelik	1K0407151AC*, 1K0407151AC 1K0407151M*, 1K0407151M 1K0407151R*, 1K0407151R
	VW6019J SALINCAK ÖN SOL RB30212	Ağırlık : 4,232 kg / 9.330 lb Malzeme Türü : Döküm Çelik	1K0407151AC, 1K0407151M 1K0407151R
	VW11180 Z-ROT BURCU ARKA	Şasi (Ön / Arka) : ARKA Ağırlık : 0,069 kg / 0.152 lb Uzunluk : VW4015 mm / 0.00 inch Aşık Diş Çapı : VW4015K	1K0505465C*, 1K0505465D* 1K0505465H*, 1K0505465J* 1K0505465K*
	VW12137 VİRAJ DEMİR LASTİĞİ	Şasi (Ön / Arka) : ARKA Ağırlık : 0,070 kg / 0.154 lb Not : Ø17mm	1K0511327AQ
	VW12137K VİRAJ DEMİR LASTİĞİ	Şasi (Ön / Arka) : ARKA Ağırlık : 0,140 kg / 0.309 lb Not : KIT	1K0511327AQ

* Bu sayfada ve katalogdaki tüm araçların adları, markaları, modelleri, sembolleri, logoları, orijinal numaraları (oe) ve diğer üçüncü parti numaraları sadece referans amaçlı kullanılmaktadır.

ROUTAN
2009 - 2014









Resim	Ürün Kodu ve Açıklaması	Detay	OEM
	CY1005 ROTİL ÖN ALT	Ağırlık : 0,5 kg / 1.102 lb	04766911AL*, 04766911AL-P part of 04766911AL
	CY2005 ROTBAŞI M14X1,5 RHT	Ağırlık : 0,574 kg / 1.265 lb Uzunluk : 143 mm / 5.63 inch Gövde Diş Çapı : M14X1,5 Aşık Diş Çapı : M12X1,25 Aşık Konik Çapı : Ø12,6	68033171AA, 68033171AB 68156146AA, 7B0422811A ES800403
	CY3007 ROTMİLİ ÖN SAĞ - SOL 358	Ağırlık : 0,67 kg / 1.477 lb Uzunluk : 358 mm / 14.09 inch Gövde Diş Çapı : M14X1,5 Aşık Diş Çapı : M14X1,5	68157856AA, 7B0498811A
	CY4001 Z ROT ÖN L=310	Ağırlık : 0,435 kg / 0.959 lb Malzeme Türü : Metal Uzunluk : 310 mm / 12.20 inch Aşık Diş Çapı : M12X1,75	4743021AA, 4743454AA 4743454AB, 4743454AC 4743669AA, 4743669AB 4743669AC, 7B0411315
	CY6013 SALINCAK ÖN ALT SAĞ	Ağırlık : 5,4 kg / 11.905 lb Malzeme Türü : Sac Metal	04766910AF, 04766910AG 04766910AH, 04766910AI 04766910AL
	CY6014 SALINCAK ÖN ALT SOL	Ağırlık : 5,4 kg / 11.905 lb Malzeme Türü : Sac Metal	04766911AF, 04766911AG 04766911AH, 04766911AI 04766911AL
	FI11051 SALINCAK VE DENGE KOLU BURCU ÖN SOL VE SAĞ	Şasi (Ön / Arka) : ÖN Yön : Sol Ve Sağ Ağırlık : 0,18 kg / 0.397 lb	05168160AB, K05168160AB
	FI11052 SALINCAK VE DENGE KOLU BURCU ÖN SOL VE SAĞ	Şasi (Ön / Arka) : ÖN Yön : Sol Ve Sağ Ağırlık : 0,405 kg / 0.893 lb	68069366AB, 68149314AB
	CY12009 AMORTİSÖR TAKOZU ÖN	Şasi (Ön / Arka) : ÖN Ağırlık : 0,835 kg / 1.841 lb	04721547AB, 04721602AB 4721547AA, 4721547AB 4721547AC, 7B0412327 7B0412327A
	CY12005 MOTOR TAKOZU ÖN	Şasi (Ön / Arka) : ÖN Ağırlık : 1,175 kg / 2.590 lb	05110501AC, 05110502AC 05110503AC, 5110501AC 5110502AC, 5110503AC K05110501AC, K05110502AC K05110503AC
	CY12006 MOTOR TAKOZU ÖN SOL	Şasi (Ön / Arka) : ÖN Yön : Sol Ağırlık : 1,790 kg / 3.946 lb	04880383AA, 4880383AA K04880383AA

* Bu sayfada ve katalogdaki tüm araçların adları, markaları, modelleri, sembolleri, logoları, orjinal numaraları (oe) ve diğer üçüncü parti numaraları sadece referans amaçlı kullanılmaktadır.

SAFARI THE KING
1970 - 1981



Resim	Ürün Kodu ve Açıklaması	Detay	OEM
	BW2013 ROTBAŞI SAĞ RB3213	Ağırlık : 0,266 kg / 0.586 lb Uzunluk : 80 mm / 3.15 inch Gövde Diş Çapı : M14X1,5 Aşık Diş Çapı : M10X1 Aşık Konik Çapı : Ø12,7	31111127317, 31211135820 32211127917, 32211127918 32211130004, 32211135820
	BW2014 ROTBAŞI RB3214	Ağırlık : 0,268 kg / 0.591 lb Uzunluk : 80 mm / 3.15 inch Gövde Diş Çapı : M14X1,5 Aşık Diş Çapı : M10X1 Aşık Konik Çapı : Ø12,7	32211127318, 32211127918 32211130001, 32211135819

SANTANA
1981 - 1984



Resim	Ürün Kodu ve Açıklaması	Detay	OEM
	VW12158 BEŞİK (TRAVERS) BURCU ARKA SOL VE SAĞ	Şasi (Ön / Arka) : ARKA Yön : Sol Ve Sağ Ağırlık : 0.22 kg / 0.485 lb	321501541
	AU12007 VİRAJ DEMİR LASTİĞİ SOL VE SAĞ RUBBER	Şasi (Ön / Arka) : ÖN Yön : Sol Ve Sağ Ağırlık : 0,02 kg / 0.044 lb Malzeme Türü : Rubber	823411327B
	AU12007K VİRAJ DEMİR LASTİĞİ SOL VE SAĞ RUBBER	Şasi (Ön / Arka) : ÖN Yön : Sol Ve Sağ Ağırlık : 0.04 kg / 0.088 lb Malzeme Türü : Rubber	823411327B*, 823411327B
	AU12008 VİRAJ DEMİR LASTİĞİ SOL VE SAĞ RUBBER	Şasi (Ön / Arka) : ÖN Yön : Sol Ve Sağ Ağırlık : 0,03 kg / 0.066 lb Malzeme Türü : Rubber	823411313A*, 823411313A
	AU12008K VİRAJ DEMİR LASTİĞİ SOL VE SAĞ RUBBER	Şasi (Ön / Arka) : ÖN Yön : Sol Ve Sağ Ağırlık : 0.06 kg / 0.132 lb Malzeme Türü : Rubber	823411313A*
	VW12104 AMORTİSÖR TAKOZU SOL VE SAĞ AMORTİSOR TABLASI	Yön : Sol Ve Sağ Ağırlık : 0,257 kg / 0.567 lb Not : AMORTİSOR TABLASI	811412323C, 811412323D 8A0412323B, 8A0412323D
	VW12104K AMORTİSÖR TAKOZU SOL VE SAĞ 2 PCS	Yön : Sol Ve Sağ Ağırlık : 0.514 kg / 1.133 lb Not : 2 PCS	811412323C, 811412323D 8A0412323B, 8A0412323D
	AU12011 ŞANZIMAN TAKOZU SOL VE SAĞ ŞANZUMAN TAKOZU	Şasi (Ön / Arka) : ÖN Yön : Sol Ve Sağ Ağırlık : 0,26 kg / 0.573 lb Not : ŞANZUMAN TAKOZU	811399151B

* Bu sayfada ve katalogdaki tüm araçların adları, markaları, modelleri, sembolleri, logoları, orijinal numaraları (oe) ve diğer üçüncü parti numaraları sadece referans amaçlı kullanılmaktadır.





SANTANA
1981 - 1984

Resim	Ürün Kodu ve Açıklaması	Detay	OEM
	AU12034 ŞANZIMAN TAKOZU	Ağırlık : 0,556 kg / 1.226 lb	811199339A, 811199339B 823199339A
	VW14013 AKS KÖRÜĞÜ +KELEPÇE+YAĞ. YAĞ+KELEPÇE	Ağırlık : 0.156 kg / 0.344 lb	113501149, 171407283A
	VW14014 AKS KÖRÜĞÜ +KELEPÇE+YAĞ. YAĞ+KELEPÇE	Ağırlık : 0.28 kg / 0.617 lb	191498203C, 71498203

SAVEIRO
III
1996 - 2003











Resim	Ürün Kodu ve Açıklaması	Detay	OEM
	VW1039 ROTİL ÖN ALT SAĞ Ø17	Ağırlık : 0,550 kg / 1.213 lb Konik Ölçüsü : Ø17	2405457
	VW1040 ROTİL ÖN ALT SOL Ø17	Ağırlık : 0,550 kg / 1.213 lb Konik Ölçüsü : Ø17	2405458

SAVEIRO
V
2009 - 2016

Resim	Ürün Kodu ve Açıklaması	Detay	OEM
	SK1025 ROTİL SAĞ	Ağırlık : 0,59 kg / 1.301 lb Konik Ölçüsü : Ø15 Bağlantı Delik Çapı : Ø10,5 Aşık Diş Çapı : M12X1,5	5U0407366A, 6R0407366 6R0407366A, 6R0407366B
	SK1026 ROTİL ÖN ALT SOL Ø15	Ağırlık : 0,59 kg / 1.301 lb Konik Ölçüsü : Ø15 Bağlantı Delik Çapı : Ø10,5 Aşık Diş Çapı : M12X1,5	5U0407365A, 6R0407365 6R0407365A, 6R0407365B
	SK2003 ROTBAŞI SAĞ RC7314	Ağırlık : 0,377 kg / 0.831 lb Uzunluk : 93,5 mm / 3.68 inch Gövde Diş Çapı : M14X1,5 Aşık Diş Çapı : M12X1,5 Aşık Konik Çapı : Ø13,5	5Z0423812, 6Q0419812C 6Q0423812, 6Q0423812A 6Q0423812C, 6Q0423812D 6R0423812, 8Z0423811A
	SK2004 ROTBAŞI SOL RC7313	Ağırlık : 0,382 kg / 0.842 lb Uzunluk : 93 mm / 3.66 inch Gövde Diş Çapı : M14X1,5 Aşık Diş Çapı : M12X1,5 Aşık Konik Çapı : Ø13,5	5Z0423811, 6Q0419811C 6Q0423811, 6Q0423811A 6Q0423811C, 6Q0423811D 6R0423811, 8Z0423812A











* Bu sayfada ve katalogdaki tüm araçların adları, markaları, modelleri, sembolleri, logoları, orjinal numaraları (oe) ve diğer üçüncü parti numaraları sadece referans amaçlı kullanılmaktadır.

SAVEIRO
V
2009 - 2016

Resim	Ürün Kodu ve Açıklaması	Detay	OEM
	SK3004 ROTMİLİ SAĞ-SOL 300 RC7817	Ağırlık : 0,536 kg / 1.182 lb Uzunluk : 300 mm / 11.81 inch Gövde Diş Çapı : M16X1,5 Aşık Diş Çapı : M14X1,5	6Q0423803A, 6Q0423804A 6Q0-423-810-C, 6Q0423821A 6Q0423821C, 6Q0423821G
	SK20033004 ROT TAKIMI ÖN AKS SAĞ RC788117	Ağırlık : 0,915 kg / 2.017 lb Rotbaşı : SK2003 Rotmili : SK3004	6Q0422804G, 6Q0423804A
	SK20043004 ROT TAKIMI ÖN AKS SOL RC788116	Ağırlık : 0,903 kg / 1.991 lb Rotbaşı : SK2004 Rotmili : SK3004	6Q0422803G, 6Q0423803A
	SK6013J SALINCAK ÖN ALT SAĞ	Ağırlık : 2,88 kg / 6.349 lb Malzeme Türü : Sac Metal	6R0407152
	SK6014J SALINCAK ÖN ALT SOL	Ağırlık : 2,88 kg / 6.349 lb Malzeme Türü : Sac Metal	6R0407151, 6R0407151E
	AU11002 SALINCAK VE DENGE KOLU BURCU ÖN SOL VE SAĞ B22117	Şasi (Ön / Arka) : ÖN Yön : Sol Ve Sağ Ağırlık : 0,108 kg / 0.238 lb	1J0407181, 1J0407181A
	AU11005 SALINCAK VE DENGE KOLU BURCU ÖN ORTA SOL VE SAĞ B40115	Şasi (Ön / Arka) : ÖN Yön : Orta Sol Ve Sağ Ağırlık : 0,111 kg / 0.245 lb Not : VW6014 - VW60614J	191407182, 357407182 357407182F
	VW12024 VİRAJ DEMİR LASTİĞİ SOL VE SAĞ RUBBER	Şasi (Ön / Arka) : ÖN Yön : Sol Ve Sağ Ağırlık : 0.03 kg / 0.066 lb Malzeme Türü : Rubber Not : VİRAJ LASTİĞİ	6Q0411303AA, 6Q0411303AD 6Q0411305H, 6Q0411314M 6Q0411314Q
	VW12024K VİRAJ DEMİR LASTİĞİ SOL VE SAĞ RUBBER	Şasi (Ön / Arka) : ÖN Yön : Sol Ve Sağ Ağırlık : 0.06 kg / 0.132 lb Malzeme Türü : Rubber Not : VİRAJ LASTİĞİ (İKİLİ)	6Q0411303AA*, 6Q0411303AA 6Q0411303AD*, 6Q0411303AD 6Q0411305H*, 6Q0411305H 6Q0411314M*, 6Q0411314M 6Q0411314Q*, 6Q0411314Q
	SE12005 MOTOR TAKOZU ARKA	Şasi (Ön / Arka) : ARKA Ağırlık : 1,115 kg / 2.458 lb	6Q0199851AS, 6Q0199851T









* Bu sayfada ve katalogdaki tüm araçların adları, markaları, modelleri, sembolleri, logoları, orijinal numaraları (oe) ve diğer üçüncü parti numaraları sadece referans amaçlı kullanılmaktadır.

SCIROCCO
1974 - 1984



Resim	Ürün Kodu ve Açıklaması	Detay	OEM
	VW1005 ROTİL ALT SOL VE SAĞ RD0512	Ağırlık : 0,346 kg / 0.763 lb Bağlantı Delik Çapı : Ø7,5	171407365C, 171407365D
	VW1006 ROTİL SAĞ RD0513	Ağırlık : 0,35 kg / 0.772 lb Bağlantı Delik Çapı : Ø7,5	171407365F, 171407365G
	VW2003 ROTBAŞI SAĞ-SOL RD0339	Ağırlık : 0,3 kg / 0.661 lb Uzunluk : 79 mm / 3.11 inch Gövde Diş Çapı : M14X1,5 Aşık Diş Çapı : M12X1,5 Aşık Konik Çapı : Ø12,3	171419811, 171419811A 171419812, 251419811 32111116463, 477419811 477419815, 94434733300
	VW3002 ROTMİLİ RD0811	Ağırlık : 0,665 kg / 1.466 lb Uzunluk : 342 mm / 13.46 inch Gövde Diş Çapı : M22X1,5 Aşık Diş Çapı : M14X1,5	171419821, 171419821A
	VW3019 ROTMİLİ ÖN SAĞ - SOL	Ağırlık : 0.55 kg / 1.213 lb Gövde Diş Çapı : M14X1,5 RHT	175422821
	VW20033002 ROT TAKIMI SOL VE SAĞ	Ağırlık : 0,963 kg / 2.123 lb Rotbaşı : VW2003 Rotmilî : VW3002	171 419 804, 171419804
	VW20033019 ROT TAKIMI ÖN AKS RD088145	Ağırlık : 0.85 kg / 1.874 lb Rotbaşı : VW2003 Rotmilî : VW3019	155422803, 155422803A 175422803
	VW6001 SALINCAK ÖN ALT SAĞ	Ağırlık : 3,652 kg / 8.051 lb Malzeme Türü : Sac Metal	171407153D
	VW6001J SALINCAK ÖN ALT	Ağırlık : 2,236 kg / 4.930 lb Malzeme Türü : Sac Metal	171407153D
	VW6002 SALINCAK ÖN ALT SOL RD1047	Ağırlık : 2,668 kg / 5.882 lb Malzeme Türü : Sac Metal	171407153D
	VW11004 SALINCAK VE DENGE KOLU BURCU SOL VE SAĞ B40112	Yön : Sol Ve Sağ Ağırlık : 0,121 kg / 0.267 lb	171407181, 171407181A

* Bu sayfada ve katalogdaki tüm araçların adları, markaları, modelleri, sembolleri, logoları, orjinal numaraları (oe) ve diğer üçüncü parti numaraları sadece referans amaçlı kullanılmaktadır.

SCIROCCO
1974 - 1984

Resim	Ürün Kodu ve Açıklaması	Detay	OEM
	VW11005 SALINCAK VE DENGE KOLU BURCU ORTA SOL VE SAĞ B40113	Yön : Orta Sol Ve Sağ Ağırlık : 0,087 kg / 0.192 lb	171407182D, 171407182E
	VW12091 MOTOR TAKOZU SOL VE SAĞ MOTOR TAKOZU	Yön : Sol Ve Sağ Ağırlık : 0,289 kg / 0.637 lb Not : MOTOR TAKOZU	171199214G
	VW12003 SÜSPANSİYON TAKOZU SOL VE SAĞ AMARTİSÖR TAKOZU ARKA	Yön : Sol Ve Sağ Ağırlık : 0,076 kg / 0.168 lb Not : AMARTİSÖR TAKOZU ARKA	171512131B
	VW12089 SÜSPANSİYON TAKOZU SOL VE SAĞ SÜSPANSİYON TAKOZU	Yön : Sol Ve Sağ Ağırlık : 0.15 kg / 0.331 lb Not : SÜSPANSİYON TAKOZU	191412303A, 357412303E
	AU12012 EGSOZ TAKOZU ÖN SOL VE SAĞ EGSOZ LASTİĞİ	Şasi (Ön / Arka) : ÖN Yön : Sol Ve Sağ Ağırlık : 0.034 kg / 0.075 lb Not : EGSOZ LASTİĞİ	191253147B, 4A0253147A
	VW13008 DİREKSİYON KÖRÜĞÜ	Ağırlık : 0.225 kg / 0.496 lb	1H0422831B
	VW14013 AKŞ KÖRÜĞÜ +KELEPÇE+YAĞ. YAĞ+KELEPÇE	Ağırlık : 0.156 kg / 0.344 lb	113501149, 171407283A
	VW14014 AKŞ KÖRÜĞÜ +KELEPÇE+YAĞ. YAĞ+KELEPÇE	Ağırlık : 0.28 kg / 0.617 lb	191498203C, 71498203

SCIROCCO
III 137
2008 - 2017

Resim	Ürün Kodu ve Açıklaması	Detay	OEM
	VW1014 ROTİL ÖN ALT SAĞ Ø15,6 RB2536	Ağırlık : 0,565 kg / 1.246 lb Konik Ölçüsü : Ø15,6 Bağlantı Delik Çapı : Ø10,5 Aşık Diş Çapı : M12X1,5	1K0407366B, 1K0407366C 1K0407366E, 5Q0407366A
	VW1015 ROTİL ÖN ALT SOL Ø15,6 RB2537	Ağırlık : 0,565 kg / 1.246 lb Konik Ölçüsü : Ø15,6 Bağlantı Delik Çapı : Ø10,5 Aşık Diş Çapı : M12X1,5	1K0407365B, 1K0407365C 1K0407365E, 5Q0407365A

* Bu sayfada ve katalogdaki tüm araçların adları, markaları, modelleri, sembolleri, logoları, orijinal numaraları (oe) ve diğer üçüncü parti numaraları sadece referans amaçlı kullanılmaktadır.

SCIROCCO
III 137
2008 - 2017

Resim	Ürün Kodu ve Açıklaması	Detay	OEM
	VW2008 ROTBAŞI ÖN SAĞ RD0342	Ağırlık : 0,412 kg / 0.908 lb Uzunluk : 95 mm / 3.74 inch Gövde Diş Çapı : M16X1,5 Aşık Diş Çapı : M12X1,5 Aşık Konik Çapı : Ø12,7	1K0423812A, 1K0423812C 1K0423812E, 1K0423812G 1K0423812J, 1K0423812K 1KD423812A
	VW2009 ROTBAŞI ÖN SOL RD0343	Ağırlık : 0,412 kg / 0.908 lb Uzunluk : 95 mm / 3.74 inch Gövde Diş Çapı : M16X1,5 Aşık Diş Çapı : M12X1,5 Aşık Konik Çapı : Ø13,5	1K0423811A, 1K0423811C 1K0423811E, 1K0423811G 1K0423811J, 1K0423811K 1KD423811A
	VW3009 ROTMİLİ SAĞ-SOL 310 RB2838	Ağırlık : 0,665 kg / 1.466 lb Uzunluk : 311 mm / 12.24 inch Gövde Diş Çapı : M16X1,5 Aşık Diş Çapı : M16X1,5	1K0423810A
	VW20083009 ROT TAKIMI ÖN AKS SAĞ RB288137	Ağırlık : 1,078 kg / 2.377 lb Rotbaşı : VW2008 Rotmilî : VW3009	
	VW20093009 ROT TAKIMI ÖN SOL RB288138	Ağırlık : 1,077 kg / 2.374 lb Rotbaşı : VW2009 Rotmilî : VW3009	
	SK4005 Z ROT ÖM SAĞ-SOL L=335MM	Ağırlık : 0,322 kg / 0.710 lb Malzeme Türü : Metal Uzunluk : 335 mm / 13.19 inch Aşık Diş Çapı : M12X1,5	5Q0411315B
	VW4014 Z ROT ÖN SAĞ-SOL METAL 335 RB2935	Ağırlık : 0,46 kg / 1.014 lb Malzeme Türü : Metal Uzunluk : 335 mm / 13.19 inch Aşık Diş Çapı : M12X1,5	1K0411315B, 1K0411315D 1K0411315J, 1K0411315K 1K0411315R, 5Q0411315A 5Q0411315B
	VW4015 Z ROT SOL VE SAĞ METAL RB2937	Ağırlık : 0,373 kg / 0.822 lb Malzeme Türü : Metal Uzunluk : 95,5 mm / 3.76 inch Aşık Diş Çapı : M10X1,5	1K0505465C, 1K0505465D 1K0505465H, 1K0505465J 1K0505465K
	VW4015K Z ROT SOL VE SAĞ METAL	Ağırlık : 0,373 kg / 0.822 lb Malzeme Türü : Metal Uzunluk : 95,5 mm / 3.76 inch Aşık Diş Çapı : M10X1,5	1K0505465C, 1K0505465D 1K0505465H, 1K0505465J 1K0505465K
	AU6010 SALINCAK ÜST SOL VE SAĞ RA5155	Ağırlık : 1,298 kg / 2.862 lb Malzeme Türü : Sac Metal	1K0505323H, 1K0505323N
	SK9001 SALINCAK ARKA ALT	Ağırlık : 0,701 kg / 1.545 lb Malzeme Türü : Sac Metal	1K0501529J







* Bu sayfada ve katalogdaki tüm araçların adları, markaları, modelleri, sembolleri, logoları, orjinal numaraları (oe) ve diğer üçüncü parti numaraları sadece referans amaçlı kullanılmaktadır.

SCIROCCO
III 137
2008 - 2017

Resim	Ürün Kodu ve Açıklaması	Detay	OEM
	VW6018 SALINCAK ÖN SAĞ RB30219	Ağırlık : 4,85 kg / 10.692 lb Malzeme Türü : Döküm Çelik	1K0407152AC*, 1K0407152M* 1K0407152P, 1K0407152Q 1K0407152R*
	VW6018J SALINCAK ÖN SAĞ RB30211	Ağırlık : 4,232 kg / 9.330 lb Malzeme Türü : Döküm Çelik	1K0407152AC, 1K0407152M 1K0407152R
	VW6019 SALINCAK ÖN SOL RB30218	Ağırlık : 4,85 kg / 10.692 lb Malzeme Türü : Döküm Çelik	1K0407151AC*, 1K0407151AC 1K0407151M*, 1K0407151M 1K0407151R*, 1K0407151R
	VW6019J SALINCAK ÖN SOL RB30212	Ağırlık : 4,232 kg / 9.330 lb Malzeme Türü : Döküm Çelik	1K0407151AC, 1K0407151M 1K0407151R
	AU11014 SALINCAK VE DENGE KOLU BURCU ARKA SOL VE SAĞ	Şasi (Ön / Arka) : ARKA Yön : Sol Ve Sağ Ağırlık : 0.192 kg / 0.423 lb	1K0505543A
	AU11052 SALINCAK VE DENGE KOLU BURCU SOL VE SAĞ	Yön : Sol Ve Sağ Ağırlık : 0,178 kg / 0.392 lb	1K0505541B, 1K0505541C 1K0505541D
	AU11088 SALINCAK VE DENGE KOLU BURCU ARKA	Şasi (Ön / Arka) : ARKA Ağırlık : 0,165 kg / 0.364 lb	1K0505541C, 1K0505541D 3C0505541
	SK11009 SALINCAK VE DENGE KOLU BURCU ARKA SOL VE SAĞ	Şasi (Ön / Arka) : ARKA Yön : Sol Ve Sağ Ağırlık : 0,176 kg / 0.388 lb	1K0501529J*
	SK11010 SALINCAK VE DENGE KOLU BURCU ARKA SOL VE SAĞ	Şasi (Ön / Arka) : ARKA Yön : Sol Ve Sağ Ağırlık : 0,196 kg / 0.432 lb Not : BÜYÜK	1K0501529J*
	VW11037 SALINCAK VE DENGE KOLU BURCU SOL VE SAĞ	Yön : Sol Ve Sağ Ağırlık : 0.11 kg / 0.243 lb	1K0505279A
	VW11042 SALINCAK VE DENGE KOLU BURCU ORTA SOL VE SAĞ	Yön : Orta Sol Ve Sağ Ağırlık : 0,182 kg / 0.401 lb	1K0407182, 5Q0407182











* Bu sayfada ve katalogdaki tüm araçların adları, markaları, modelleri, sembolleri, logoları, orijinal numaraları (oe) ve diğer üçüncü parti numaraları sadece referans amaçlı kullanılmaktadır.

SCIROCCO
III 137
2008 - 2017

Resim	Ürün Kodu ve Açıklaması	Detay	OEM
	VW11043 SALINCAK VE DENGE KOLU BURCU SAĞ B22141	Yön : Sağ Diğer Taraf : VW11044 Ağırlık : 0,659 kg / 1.453 lb	1K0199232G, 1K0199232H 1K0199232J
	VW11043B SALINCAK VE DENGE KOLU BURCU SAĞ	Yön : Sağ Diğer Taraf : VW11044B Ağırlık : 0,659 kg / 1.453 lb Not : İÇ BURÇSUZ	1K0199232G, 1K0199232H 1K0199232J
	VW11044 SALINCAK VE DENGE KOLU BURCU SOL B22142	Yön : Sol Diğer Taraf : VW11043 Ağırlık : 0,678 kg / 1.495 lb	1K0199231G, 1K0199231H 1K0199231J
	VW11044B SALINCAK VE DENGE KOLU BURCU SOL	Yön : Sol Diğer Taraf : VW11043B Ağırlık : 0,678 kg / 1.495 lb Not : İÇ BURÇSUZ	1K0199231G, 1K0199231H 1K0199231J
	VW11051 SALINCAK VE DENGE KOLU BURCU SOL VE SAĞ	Yön : Sol Ve Sağ Ağırlık : 0.121 kg / 0.267 lb	6Q0407183, 6Q0407183A
	VW11180 Z-ROT BURCU ARKA	Şasi (Ön / Arka) : ARKA Ağırlık : 0.069 kg / 0.152 lb Uzunluk : VW4015 mm / 0.00 inch Aşık Dış Çapı : VW4015K	1K0505465C*, 1K0505465D* 1K0505465H*, 1K0505465J* 1K0505465K*
	VW12159 TAŞIYICI DESTEK BURÇLARI ARKA SOL VE SAĞ	Şasi (Ön / Arka) : ARKA Yön : Sol Ve Sağ Ağırlık : 0,130 kg / 0.287 lb	1K0505553, 1K0505553A
	VW12017 AMORTİSÖR TAKOZU SOL VE SAĞ AMORTİSÖR TAKOZU	Yön : Sol Ve Sağ Ağırlık : 0.847 kg / 1.867 lb Not : AMORTİSÖR TAKOZU	1K0412331B, 1K0412331C
	VW12109 AMORTİSÖR TAKOZU SOL VE SAĞ AMORTİSÖR RULMANI	Yön : Sol Ve Sağ Ağırlık : 0.26 kg / 0.573 lb Not : AMORTİSÖR RULMANI	6N0412249C, 6N0412249E
	VW12109K AMORTİSÖR TAKOZU SOL VE SAĞ 2 PCS	Yön : Sol Ve Sağ Ağırlık : 0.52 kg / 1.146 lb Not : 2 PCS	6N0412249C, 6N0412249E
	VW12027 MOTOR TAKOZU SOL VE SAĞ MOTOR KULAĞI	Yön : Sol Ve Sağ Ağırlık : 2.02 kg / 4.453 lb Not : MOTOR KULAĞI	1K0199262, 1K0199262CN

* Bu sayfada ve katalogdaki tüm araçların adları, markaları, modelleri, sembolleri, logoları, orjinal numaraları (oe) ve diğer üçüncü parti numaraları sadece referans amaçlı kullanılmaktadır.

SCIROCCO
III 137
2008 - 2017









Resim	Ürün Kodu ve Açıklaması	Detay	OEM
	VW12029 MOTOR TAKOZU SOL VE SAĞ MOTOR TAKOZU	Yön : Sol Ve Sağ Ağırlık : 0.585 kg / 1.290 lb Not : Motor takozu	1K0199855AD, 1K0199855BA 1K0199855K
	VW12077 MOTOR TAKOZU SOL VE SAĞ MOTOR TAKOZU	Yön : Sol Ve Sağ Ağırlık : 1.95 kg / 4.299 lb Not : MOTOR TAKOZU	1K0199262CG, 1K0199262CP
	VW12078 MOTOR TAKOZU SOL VE SAĞ ŞANZUMAN TAKOZU	Yön : Sol Ve Sağ Ağırlık : 1.78 kg / 3.924 lb Not : ŞANZUMAN TAKOZU	1K0199555AC
	VW12097 MOTOR TAKOZU SOL VE SAĞ MOTOR TAKOZU	Yön : Sol Ve Sağ Ağırlık : 0.251 kg / 0.553 lb Not : MOTOR TAKOZU	1K0199868, 1K0199868A 1K0199868C, 1K0199868P 1K0199868Q
	VW12110 MOTOR TAKOZU SOL VE SAĞ MOTOR TAKOZU	Yön : Sol Ve Sağ Ağırlık : 1.918 kg / 4.228 lb Not : MOTOR TAKOZU	1K0199262AB, 1K0199262AM 1K0199262M
	VW12051 SÜSPANSİYON TAKOZU SOL VE SAĞ LASTİK DAYANAK SÜSPANSİYON	Yön : Sol Ve Sağ Ağırlık : 0.045 kg / 0.099 lb Not : LASTİK DAYANAK SÜSPANSİYON	1K0412303B
	VW12086 RADYATÖR TAKOZU SOL VE SAĞ RADYATÖR ÜST LASTİĞİ	Yön : Sol Ve Sağ Ağırlık : 0.024 kg / 0.053 lb Not : RADYATÖR ÜST LASTİĞİ	1K0121367F
	VW13006 DİREKSİYON KÖRÜĞÜ	Ağırlık : 0.145 kg / 0.320 lb	1K0423831A, 5C0423831
	VW13006K DİREKSİYON KÖRÜĞÜ SOL VE SAĞ 2 PİECES	Ağırlık : 0.29 kg / 0.639 lb	1K0423831A, 5C0423831
	VW13010 DİREKSİYON KÖRÜĞÜ ÖN	Ağırlık : 0,124 kg / 0.273 lb	191422831
	VW14003 AKS KÖRÜĞÜ +KELEPÇE+YAĞ. DIŞ	Ağırlık : 0.25 kg / 0.551 lb	1K0 498 203, 1K0498203

* Bu sayfada ve katalogdaki tüm araçların adları, markaları, modelleri, sembolleri, logoları, orjinal numaraları (oe) ve diğer üçüncü parti numaraları sadece referans amaçlı kullanılmaktadır.

SCIROCCO
III 137
2008 - 2017

Resim	Ürün Kodu ve Açıklaması	Detay	OEM
	AU15001 AMORTİSÖR KÖRÜĞÜ ÖN	Şasi (Ön / Arka) : ÖN Ağırlık : 0,110 kg / 0.243 lb	6N0413175A
	VW15002 AMORTİSÖR KÖRÜĞÜ ARKA	Şasi (Ön / Arka) : ARKA	900064

SHARAN
7M6, 7M8, 7M9
1995 - 2010

Resim	Ürün Kodu ve Açıklaması	Detay	OEM
	VW1025 ROTİL SAĞ-SOL ÜST RB6527	Ağırlık : 0,515 kg / 1.135 lb Konik Ölçüsü : Ø18,4 Bağlantı Delik Çapı : Ø11 Aşık Diş Çapı : M14X1,5	, 1111156 7200946, 7M0407365A 7M3407365A, 95VW3395AA YM213395BA
	VW2018 ROTBAŞI SAĞ RB6337	Ağırlık : 0,815 kg / 1.797 lb Uzunluk : 220 mm / 8.66 inch Gövde Diş Çapı : M14X1,5 Aşık Diş Çapı : M12X1,5 Aşık Konik Çapı : Ø14,4	, 1058378 1092377, 1092378 1234258, 7M0422818 7M0422818A, 7M0422818B 7M3422818
	VW2019 ROTBAŞI SOL RB6336	Ağırlık : 1,056 kg / 2.328 lb Uzunluk : 220 mm / 8.66 inch Gövde Diş Çapı : M14X1,5 Aşık Diş Çapı : M12X1,5 Aşık Konik Çapı : Ø14,4	1058380, 1092380 1234259, 3M213281AA 7M0422817, 7M0422817A 7M0422817B, 7M3422817 95VW3281BB, 95VW3281BC
	VW3014 ROTMİLİ SAĞ-SOL RB6834	Ağırlık : 0,418 kg / 0.922 lb Uzunluk : 183 mm / 7.20 inch Gövde Diş Çapı : M14X1,5 Aşık Diş Çapı : M14X1,5	1001398, 1121509 7M0422821F, 7M3422803 7M3422804, 7M3422821 7M3422821F, 95VW3281AG 95VW3281AH
	VW20183014 ROT TAKIMI ÖN AKS SAĞ RB688135	Ağırlık : 1,25 kg / 2.756 lb Rotbaşı : VW2018 Rotmili : VW3014	1001395, 1001396 1020496, 1092376 1121508, 1233553 7200944, 7398676 7M0422804F, 7M0422804G
	VW20193014 ROT TAKIMI ÖN AKS SOL RB688136	Ağırlık : 1,24 kg / 2.734 lb Rotbaşı : VW2019 Rotmili : VW3014	1001397, 1001398 1020497, 109232 1092382, 1121509 1233552, 7M0422803F 7M0422803G, 7M3422803
	VW4021 Z ROT ÖN SAĞ-SOL RB6914	Ağırlık : 0,35 kg / 0.772 lb Malzeme Türü : Metal Uzunluk : 205 mm / 8.07 inch Aşık Diş Çapı : M12X1,5	1009591, 1141774 1232756, 1353188 1361653, 1M0411317D 1M215489AB, 7200959 7M0411317C, 7M0411317D
	VW6021 SALINCAK ÖN SAĞ RB7059	Ağırlık : 4,291 kg / 9.460 lb Malzeme Türü : Dövme Çelik	1012632, 7M0407152B 95VW3078AC

* Bu sayfada ve katalogdaki tüm araçların adları, markaları, modelleri, sembolleri, logoları, orijinal numaraları (oe) ve diğer üçüncü parti numaraları sadece referans amaçlı kullanılmaktadır.

SHARAN
7M6, 7M8, 7M9
1995 - 2010



Resim	Ürün Kodu ve Açıklaması	Detay	OEM
	VW6022 SALINCAK ÖN SOL RB7058	Ağırlık : 4,323 kg / 9.531 lb Malzeme Türü : Dövme Çelik	1007602, 7M0407151B 95VW3079AC
	VW11057 SALINCAK VE DENGE KOLU BURCU SOL VE SAĞ B26117	Yön : Sol Ve Sağ Ağırlık : 0,11 kg / 0.243 lb	701407183, 7201717 7M0501541
	VW11058 SALINCAK VE DENGE KOLU BURCU ÖN SOL VE SAĞ B26118	Şasi (Ön / Arka) : ÖN Yön : Sol Ve Sağ Ağırlık : 0,179 kg / 0.395 lb	1044571, 7396830 7M0407181, 7M0407181A 95VW3A252BA, 95VW5A638CA
	FO12070 BEŞİK (TRAVERS) BURCU ARKA SOL VE SAĞ	Şasi (Ön / Arka) : ARKA Yön : Sol Ve Sağ Ağırlık : 0,530 kg / 1.168 lb	7201723, 7M0505222B 95VW5K817DB
	VW12006 AMORTİSÖR TAKOZU SOL VE SAĞ AMORTİSÖR ÜST TAKOZU	Yön : Sol Ve Sağ Ağırlık : 0.445 kg / 0.981 lb Not : AMORTİSÖR ÜST TAKOZU	357412331A, 7201848 7M0412331, 95VW3K031AA
	RN14017 AKS KÖRÜĞÜ +KELEPÇE+YAĞ. DIŞ	Ağırlık : 0.28 kg / 0.617 lb	1075638, 1109786 272440, 272483 3301685, 701498203A 7701470155, 7M0407285A 7M0498203, 8994154
	VW14011 AKS KÖRÜĞÜ +KELEPÇE+YAĞ. İÇ	Ağırlık : 0.236 kg / 0.520 lb	1K0498201D
	AU15001 AMORTİSÖR KÖRÜĞÜ ÖN	Şasi (Ön / Arka) : ÖN Ağırlık : 0,110 kg / 0.243 lb	6N0413175A

SHARAN
7N1, 7N2
2010 - 2022

Resim	Ürün Kodu ve Açıklaması	Detay	OEM
	VW1019 ROTİL ÖN SAĞ Ø15,3 RB2538	Ağırlık : 0,555 kg / 1.224 lb Konik Ölçüsü : Ø15,3 Bağlantı Delik Çapı : Ø10,5 Aşık Diş Çapı : M12X1,5	3C0407366A
	VW1020 ROTİL ÖN SOL Ø15,3 RB2539	Ağırlık : 0,555 kg / 1.224 lb Konik Ölçüsü : Ø15,3 Bağlantı Delik Çapı : Ø10,5 Aşık Diş Çapı : M12X1,5	3C0407365A

* Bu sayfada ve katalogdaki tüm araçların adları, markaları, modelleri, sembolleri, logoları, orjinal numaraları (oe) ve diğer üçüncü parti numaraları sadece referans amaçlı kullanılmaktadır.

SHARAN**7N1, 7N2****2010 - 2022**

Resim	Ürün Kodu ve Açıklaması	Detay	OEM
	VW2008 ROTBAŞI ÖN SAĞ RD0342	Ağırlık : 0,412 kg / 0.908 lb Uzunluk : 95 mm / 3.74 inch Gövde Diş Çapı : M16X1,5 Aşık Diş Çapı : M12X1,5 Aşık Konik Çapı : Ø12,7	1K0423812A, 1K0423812C 1K0423812E, 1K0423812G 1K0423812J, 1K0423812K 1KD423812A
	VW2009 ROTBAŞI ÖN SOL RD0343	Ağırlık : 0,412 kg / 0.908 lb Uzunluk : 95 mm / 3.74 inch Gövde Diş Çapı : M16X1,5 Aşık Diş Çapı : M12X1,5 Aşık Konik Çapı : Ø13,5	1K0423811A, 1K0423811C 1K0423811E, 1K0423811G 1K0423811J, 1K0423811K 1KD423811A
	VW3009 ROTMİLİ SAĞ-SOL 310 RB2838	Ağırlık : 0,665 kg / 1.466 lb Uzunluk : 311 mm / 12.24 inch Gövde Diş Çapı : M16X1,5 Aşık Diş Çapı : M16X1,5	1K0423810A











VW8002 / Süspansiyon Kit Ön
SHARAN
7N1, 7N2
2010 - 2022

Kit Parçaları

Resim	Ürün Kodu / Adı	OEM	OEM	Ürün Kodu / Adı	Resim
	VW2008 Rotbaşı Ön Sağ Rd0342	1K0423812A, 1K0423812C 1K0423812E, 1K0423812G 1K0423812J, 1K0423812K 1KD423812A	1K0423811A, 1K0423811C 1K0423811E, 1K0423811G 1K0423811J, 1K0423811K 1KD423811A	VW2009 Rotbaşı Ön Sol Rd0343	
	VW3009 Rotmili Sağ-sol 310 Rb2838	1K0423810A	1K0411315B, 1K0411315D 1K0411315J, 1K0411315K 1K0411315R, 5Q0411315A 5Q0411315B	VW4014 Z Rot Ön Sağ-sol Metal 335 Rb2935	
	VW6032 Salıncak Ön Sağ Rd1051	3C0407151A, 3C0407151B 3C0407151E, 3C0407151G*	3C0407151A, 3C0407151B 3C0407151E, 3C0407151H*	VW6033 Salıncak Ön Sol Rd1052	



* Bu sayfada ve katalogdaki tüm araçların adları, markaları, modelleri, sembolleri, logoları, orjinal numaraları (oe) ve diğer üçüncü parti numaraları sadece referans amaçlı kullanılmaktadır.

SHARAN
7N1, 7N2
2010 - 2022

Resim	Ürün Kodu ve Açıklaması	Detay	OEM
	VW20083009 ROT TAKIMI ÖN AKS SAĞ RB288137	Ağırlık : 1,078 kg / 2.377 lb Rotbaşı : VW2008 Rotmili : VW3009	
	VW20093009 ROT TAKIMI ÖN SOL RB288138	Ağırlık : 1,077 kg / 2.374 lb Rotbaşı : VW2009 Rotmili : VW3009	
	SK4005 Z ROT ÖM SAĞ-SOL L=335MM	Ağırlık : 0,322 kg / 0.710 lb Malzeme Türü : Metal Uzunluk : 335 mm / 13.19 inch Aşık Diş Çapı : M12X1,5	5Q0411315B
	AU6010 SALINCAK ÜST SOL VE SAĞ RA5155	Ağırlık : 1,298 kg / 2.862 lb Malzeme Türü : Sac Metal	1K0505323H, 1K0505323N
	AU9037 SALINCAK ARKA ALT SAĞ SAC LEVHA	Ağırlık : 1,735 kg / 3.825 lb Malzeme Türü : Sac Metal	3C0505224E
	AU9038 SALINCAK VE DENGE KOLU ARKA ALT SOL SAC LEVHA	Ağırlık : 1,735 kg / 3.825 lb Malzeme Türü : Sac Metal	3C0505223E
	SK9001 SALINCAK ARKA ALT	Ağırlık : 0,701 kg / 1.545 lb Malzeme Türü : Sac Metal	1K0501529J
	VW6032 SALINCAK ÖN SAĞ RD1051	Ağırlık : 3,441 kg / 7.586 lb Malzeme Türü : Alüminyum	3C0407151A, 3C0407151B 3C0407151E, 3C0407151G*
	VW6032J SALINCAK ÖN RD1050	Ağırlık : 2,9 kg / 6.393 lb Malzeme Türü : Alüminyum	3C0407151A, 3C0407151B 3C0407151E, 3C0407151G 3C0407151H
	VW6033 SALINCAK ÖN SOL RD1052	Ağırlık : 3,441 kg / 7.586 lb Malzeme Türü : Alüminyum	3C0407151A, 3C0407151B 3C0407151E, 3C0407151H*
	VW6059 SALINCAK ÖN ALT SAĞ	Ağırlık : 3,490 kg / 7.694 lb Malzeme Türü : Alüminyum	3C0407152A, 3C0407152B 3C0407152E











* Bu sayfada ve katalogdaki tüm araçların adları, markaları, modelleri, sembolleri, logoları, orijinal numaraları (oe) ve diğer üçüncü parti numaraları sadece referans amaçlı kullanılmaktadır.

SHARAN
7N1, 7N2
2010 - 2022

Resim	Ürün Kodu ve Açıklaması	Detay	OEM
	VW6060 SALINCAK ALT SOL	Ağırlık : 3,490 kg / 7.694 lb Malzeme Türü : Alüminyum	3C0407151A, 3C0407151B 3C0407151E
	AU11052 SALINCAK VE DENGE KOLU BURCU SOL VE SAĞ	Yön : Sol Ve Sağ Ağırlık : 0,178 kg / 0.392 lb	1K0505541B, 1K0505541C 1K0505541D
	AU11088 SALINCAK VE DENGE KOLU BURCU ARKA	Şasi (Ön / Arka) : ARKA Ağırlık : 0,165 kg / 0.364 lb	1K0505541C, 1K0505541D 3C0505541
	SK11009 SALINCAK VE DENGE KOLU BURCU ARKA SOL VE SAĞ	Şasi (Ön / Arka) : ARKA Yön : Sol Ve Sağ Ağırlık : 0,176 kg / 0.388 lb	1K0501529J*
	SK11010 SALINCAK VE DENGE KOLU BURCU ARKA SOL VE SAĞ	Şasi (Ön / Arka) : ARKA Yön : Sol Ve Sağ Ağırlık : 0,196 kg / 0.432 lb Not : BÜYÜK	1K0501529J*
	VW11037 SALINCAK VE DENGE KOLU BURCU SOL VE SAĞ	Yön : Sol Ve Sağ Ağırlık : 0.11 kg / 0.243 lb	1K0505279A
	VW11042 SALINCAK VE DENGE KOLU BURCU ORTA SOL VE SAĞ	Yön : Orta Sol Ve Sağ Ağırlık : 0,182 kg / 0.401 lb	1K0407182, 5Q0407182
	VW11046 SALINCAK VE DENGE KOLU BURCU SAĞ B40133	Yön : Sağ Ağırlık : 0,6 kg / 1.323 lb	3C0199231A, 3C0199231B 3C0199231D
	VW11046B SALINCAK VE DENGE KOLU BURCU SAĞ	Yön : Sağ Ağırlık : 0.445 kg / 0.981 lb Not : BURÇ GÖVDESİ	3C0199231A, 3C0199231B 3C0199231D
	VW11051 SALINCAK VE DENGE KOLU BURCU SOL VE SAĞ	Yön : Sol Ve Sağ Ağırlık : 0.121 kg / 0.267 lb	6Q0407183, 6Q0407183A
	VW12159 TAŞIYICI DESTEK BURÇLARI ARKA SOL VE SAĞ	Şasi (Ön / Arka) : ARKA Yön : Sol Ve Sağ Ağırlık : 0,130 kg / 0.287 lb	1K0505553, 1K0505553A

* Bu sayfada ve katalogdaki tüm araçların adları, markaları, modelleri, sembolleri, logoları, orjinal numaraları (oe) ve diğer üçüncü parti numaraları sadece referans amaçlı kullanılmaktadır.

SHARAN
7N1, 7N2
2010 - 2022





Resim	Ürün Kodu ve Açıklaması	Detay	OEM
	AU12024 TORSİYON BURCU ARKA SOL VE SAĞ	Şasi (Ön / Arka) : ARKA Yön : Sol Ve Sağ Ağırlık : 0.557 kg / 1.228 lb	1K0505145F, 1K0505145H 1K0505145K
	VW12137 VİRAJ DEMİR LASTİĞİ	Şasi (Ön / Arka) : ARKA Ağırlık : 0,070 kg / 0.154 lb Not : Ø17mm	1K0511327AQ
	VW12137K VİRAJ DEMİR LASTİĞİ	Şasi (Ön / Arka) : ARKA Ağırlık : 0,140 kg / 0.309 lb Not : KIT	1K0511327AQ
	VW12006 AMORTİSÖR TAKOZU SOL VE SAĞ AMORTİSÖR ÜST TAKOZU	Yön : Sol Ve Sağ Ağırlık : 0.445 kg / 0.981 lb Not : AMORTİSÖR ÜST TAKOZU	357412331A, 7201848 7M0412331, 95VW3K031AA
	AU12021 MOTOR TAKOZU SOL VE SAĞ MOTOR TAKOZU	Yön : Sol Ve Sağ Ağırlık : 0.6 kg / 1.323 lb Malzeme Türü : Motor Takozu	5N0199855B, 5N0199855C 5N0199855E
	VW12097 MOTOR TAKOZU SOL VE SAĞ MOTOR TAKOZU	Yön : Sol Ve Sağ Ağırlık : 0.251 kg / 0.553 lb Not : MOTOR TAKOZU	1K0199868, 1K0199868A 1K0199868C, 1K0199868P 1K0199868Q
	VW12134 MOTOR TAKOZU ÖN SOL	Şasi (Ön / Arka) : ÖN Yön : Sol Ağırlık : 2,145 kg / 4.729 lb	5N0199262D, 5N0199262M 5N0199262N
	VW12051 SÜSPANSİYON TAKOZU SOL VE SAĞ LASTİK DAYANAK SUSPENSİYON	Yön : Sol Ve Sağ Ağırlık : 0.045 kg / 0.099 lb Not : LASTİK DAYANAK SUSPENSİYON	1K0412303B
	VW12086 RADYATÖR TAKOZU SOL VE SAĞ RADYATÖR ÜST LASTİĞİ	Yön : Sol Ve Sağ Ağırlık : 0.024 kg / 0.053 lb Not : RADYATÖR ÜST LASTİĞİ	1K0121367F
	VW13006 DİREKSİYON KÖRÜĞÜ	Ağırlık : 0.145 kg / 0.320 lb	1K0423831A, 5C0423831
	VW13006K DİREKSİYON KÖRÜĞÜ SOL VE SAĞ 2 PİECES	Ağırlık : 0.29 kg / 0.639 lb	1K0423831A, 5C0423831

* Bu sayfada ve katalogdaki tüm araçların adları, markaları, modelleri, sembolleri, logoları, orjinal numaraları (oe) ve diğer üçüncü parti numaraları sadece referans amaçlı kullanılmaktadır.

TAIGO
2021 -

Resim	Ürün Kodu ve Açıklaması	Detay	OEM
	SE2008 ROTBAŞI SAĞ	Ağırlık : 0,426 kg / 0.939 lb Uzunluk : 95 mm / 3.74 inch Gövde Diş Çapı : M16X1,5 Aşık Diş Çapı : M12X1,5 Aşık Konik Çapı : Ø13,3	2Q0423812, 2QB423812
	SE2009 ROTBAŞI SOL	Ağırlık : 0,426 kg / 0.939 lb Uzunluk : 95 mm / 3.74 inch Gövde Diş Çapı : M16X1,5 Aşık Diş Çapı : M12X1,5 Aşık Konik Çapı : Ø13,3	2Q0423811, 2QB423811

TARO
1989 - 1997









Resim	Ürün Kodu ve Açıklaması	Detay	OEM
	TO1016 ROTİL ÖN ÜST Ø16,75 RE3534	Ağırlık : 0,921 kg / 2.030 lb Konik Ölçüsü : Ø16,75 Bağlantı Delik Çapı : Ø8 Aşık Diş Çapı : M16X1,5	43330-39265, 43330-39315 43340-39245, 43350-29085 4335039045, 43350-39045 43350-39085, 43360-39075 4336039085, 43360-39085
	TO2033 ROTBAŞI INNER RE3231	Ağırlık : 0,541 kg / 1.193 lb Uzunluk : 186 mm / 7.32 inch Gövde Diş Çapı : M17X1,5 Aşık Diş Çapı : M14X1,5 Aşık Konik Çapı : Ø14,5	3817.74, 45046-29115 45046-39095, 45046-39115 45046-39125, 4540629115 45406-39085, J45 406 391 15
	TO6028J SALINCAK ÖN ALT SAĞ	Ağırlık : 3,126 kg / 6.892 lb Malzeme Türü : Sac Metal	45605-35121*, 48605-35100* 48605-35120*, 48605-35120
	TO6029J SALINCAK ÖN ALT SOL	Ağırlık : 3,204 kg / 7.064 lb Malzeme Türü : Sac Metal	48069-29095*, 48069-29095 48606-35120*, 48606-35120 48606-35121*, 48606-35121
	TO7001 DEVE BOYNU SOL VE SAĞ	Şasi (Ön / Arka) : ÖN Yön : Sol Ve Sağ Ağırlık : 1,355 kg / 2.987 lb	45490-39315, 45490-39316 45490-39360

TAYRON
II
2025 -

Resim	Ürün Kodu ve Açıklaması	Detay	OEM
	VW1031 ROTİL ÖN ALT SAĞ Ø15,2	Ağırlık : 0,59 kg / 1.301 lb Konik Ölçüsü : Ø15,2 Aşık Diş Çapı : M12X1,5	3C0407366B
	VW1032 ROTİL ÖN ALT SOL Ø15,2	Ağırlık : 0,59 kg / 1.301 lb Konik Ölçüsü : Ø15,2 Aşık Diş Çapı : M12X1,5	3C0407365B

* Bu sayfada ve katalogdaki tüm araçların adları, markaları, modelleri, sembolleri, logoları, orjinal numaraları (oe) ve diğer üçüncü parti numaraları sadece referans amaçlı kullanılmaktadır.

TAYRON
II
2025 -





Resim	Ürün Kodu ve Açıklaması	Detay	OEM
	VW2033 ROTBAŞI SAĞ	Ağırlık : 0,525 kg / 1.157 lb	5WA423812E
	VW2034 ROTBAŞI SOL	Ağırlık : 0,525 kg / 1.157 lb	5WA423811E
	VW4014 Z ROT ÖN SAĞ-SOL METAL 335 RB2935	Ağırlık : 0,46 kg / 1.014 lb Malzeme Türü : Metal Uzunluk : 335 mm / 13.19 inch Aşık Diş Çapı : M12X1,5	1K0411315B, 1K0411315D 1K0411315J, 1K0411315K 1K0411315R, 5Q0411315A 5Q0411315B
	VW4035 Z ROT ARKA PLASTİK	Ağırlık : 0,165 kg / 0.364 lb Malzeme Türü : Plastik Uzunluk : 111 mm / 4.37 inch	5WA505465A
	VW6055J SALINCAK ÖN ALT SAĞ	Malzeme Türü : Sac Metal	3Q0407152E, 3Q0407152F 3Q0407154B
	VW6056J SALINCAK ÖN ALT SOL	Malzeme Türü : Sac Metal	3Q0407151E, 3Q0407151F 3Q0407153B
	VW9004 SALINCAK ARKA	Ağırlık : 1,3 kg / 2.866 lb Malzeme Türü : Sac Metal	5Q0505323C, 5Q0505323D
	VW11037 SALINCAK VE DENGE KOLU BURCU SOL VE SAĞ	Yön : Sol Ve Sağ Ağırlık : 0.11 kg / 0.243 lb	1K0505279A
	VW11042 SALINCAK VE DENGE KOLU BURCU ORTA SOL VE SAĞ	Yön : Orta Sol Ve Sağ Ağırlık : 0,182 kg / 0.401 lb	1K0407182, 5Q0407182
	VW11056 SALINCAK VE DENGE KOLU BURCU ARKA SOL VE SAĞ	Şasi (Ön / Arka) : ARKA Yön : Sol Ve Sağ Ağırlık : 0.13 kg / 0.287 lb	1K0505203A, 1K0505323D 1K0505323G, 1K0505323H 1K0505323N, 5Q0505323C
	VW11063 SALINCAK VE DENGE KOLU BURCU SOL VE SAĞ	Yön : Sol Ve Sağ Ağırlık : 0.34 kg / 0.750 lb	5Q0407183D, 5Q0407183E

* Bu sayfada ve katalogdaki tüm araçların adları, markaları, modelleri, sembolleri, logoları, orjinal numaraları (oe) ve diğer üçüncü parti numaraları sadece referans amaçlı kullanılmaktadır.

T-CROSS
C11
2019 -

Resim	Ürün Kodu ve Açıklaması	Detay	OEM
	VW1014 ROTİL ÖN ALT SAĞ Ø15,6 RB2536	Ağırlık : 0,565 kg / 1.246 lb Konik Ölçüsü : Ø15,6 Bağlantı Delik Çapı : Ø10,5 Aşık Diş Çapı : M12X1,5	1K0407366B, 1K0407366C 1K0407366E, 5Q0407366A
	VW1015 ROTİL ÖN ALT SOL Ø15,6 RB2537	Ağırlık : 0,565 kg / 1.246 lb Konik Ölçüsü : Ø15,6 Bağlantı Delik Çapı : Ø10,5 Aşık Diş Çapı : M12X1,5	1K0407365B, 1K0407365C 1K0407365E, 5Q0407365A
	SE2008 ROTBAŞI SAĞ	Ağırlık : 0,426 kg / 0.939 lb Uzunluk : 95 mm / 3.74 inch Gövde Diş Çapı : M16X1,5 Aşık Diş Çapı : M12X1,5 Aşık Konik Çapı : Ø13,3	2Q0423812, 2QB423812
	SE2009 ROTBAŞI SOL	Ağırlık : 0,426 kg / 0.939 lb Uzunluk : 95 mm / 3.74 inch Gövde Diş Çapı : M16X1,5 Aşık Diş Çapı : M12X1,5 Aşık Konik Çapı : Ø13,3	2Q0423811, 2QB423811
	VW3025 ROTMİLİ SOL VE SAĞ 311	Ağırlık : 0,676 kg / 1.490 lb Uzunluk : 311 mm / 12.24 inch Gövde Diş Çapı : M14X1,5 Aşık Diş Çapı : M16X1,5	2Q0423810D
	VW6063 SALINCAK ÖN ALT SAĞ	Ağırlık : 3,004 kg / 6.623 lb Malzeme Türü : Sac Metal	2Q0407152B
	VW6063J SALINCAK ÖN ALT SAĞ	Ağırlık : 2,439 kg / 5.377 lb Malzeme Türü : Sac Metal	2Q0407152B
	VW6064 SALINCAK ÖN ALT SOL	Ağırlık : 3,004 kg / 6.623 lb Malzeme Türü : Sac Metal	2Q0407151B
	VW6064J SALINCAK ÖN ALT SOL	Ağırlık : 2,439 kg / 5.377 lb Malzeme Türü : Sac Metal	2Q0407151B
	AU12027 AMORTİSÖR TAKOZU ARKA ÜST SAĞ	Şasi (Ön / Arka) : ARKA Yön : Üst Sağ Ağırlık : 0,415 kg / 0.915 lb	5Q0513353H

TIGUAN
I 5N
2007 - 2016

Resim	Ürün Kodu ve Açıklaması	Detay	OEM
	VW1019 ROTİL ÖN SAĞ Ø15,3 RB2538	Ağırlık : 0,555 kg / 1.224 lb Konik Ölçüsü : Ø15,3 Bağlantı Delik Çapı : Ø10,5 Aşık Diş Çapı : M12X1,5	3C0407366A
	VW1020 ROTİL ÖN SOL Ø15,3 RB2539	Ağırlık : 0,555 kg / 1.224 lb Konik Ölçüsü : Ø15,3 Bağlantı Delik Çapı : Ø10,5 Aşık Diş Çapı : M12X1,5	3C0407365A
	VW2008 ROTBAŞI ÖN SAĞ RD0342	Ağırlık : 0,412 kg / 0.908 lb Uzunluk : 95 mm / 3.74 inch Gövde Diş Çapı : M16X1,5 Aşık Diş Çapı : M12X1,5 Aşık Konik Çapı : Ø12,7	1K0423812A, 1K0423812C 1K0423812E, 1K0423812G 1K0423812J, 1K0423812K 1KD423812A
	VW2009 ROTBAŞI ÖN SOL RD0343	Ağırlık : 0,412 kg / 0.908 lb Uzunluk : 95 mm / 3.74 inch Gövde Diş Çapı : M16X1,5 Aşık Diş Çapı : M12X1,5 Aşık Konik Çapı : Ø13,5	1K0423811A, 1K0423811C 1K0423811E, 1K0423811G 1K0423811J, 1K0423811K 1KD423811A
	VW3009 ROTMİLİ SAĞ-SOL 310 RB2838	Ağırlık : 0,665 kg / 1.466 lb Uzunluk : 311 mm / 12.24 inch Gövde Diş Çapı : M16X1,5 Aşık Diş Çapı : M16X1,5	1K0423810A

VW8002 / Süspansiyon Kit Ön

TIGUAN

I 5N

2007 - 2016













Kit Parçaları

Resim	Ürün Kodu / Adı	OEM	OEM	Ürün Kodu / Adı	Resim
	VW2008 Rotbaşı Ön Sağ Rd0342	1K0423812A, 1K0423812C 1K0423812E, 1K0423812G 1K0423812J, 1K0423812K 1KD423812A	1K0423811A, 1K0423811C 1K0423811E, 1K0423811G 1K0423811J, 1K0423811K 1KD423811A	VW2009 Rotbaşı Ön Sol Rd0343	
	VW3009 Rotmili Sağ-sol 310 Rb2838	1K0423810A	1K0411315B, 1K0411315D 1K0411315J, 1K0411315K 1K0411315R, 5Q0411315A 5Q0411315B	VW4014 Z Rot Ön Sağ-sol Metal 335 Rb2935	
	VW6032 Salıncak Ön Sağ Rd1051	3C0407151A, 3C0407151B 3C0407151E, 3C0407151G*	3C0407151A, 3C0407151B 3C0407151E, 3C0407151H*	VW6033 Salıncak Ön Sol Rd1052	

* Bu sayfada ve katalogdaki tüm araçların adları, markaları, modelleri, sembolleri, logoları, orjinal numaraları (oe) ve diğer üçüncü parti numaraları sadece referans amaçlı kullanılmaktadır.

TIGUAN
I 5N
2007 - 2016

Resim	Ürün Kodu ve Açıklaması	Detay	OEM
	VW20083009 ROT TAKIMI ÖN AKS SAĞ RB288137	Ağırlık : 1,078 kg / 2.377 lb Rotbaşı : VW2008 Rotmili : VW3009	
	VW20093009 ROT TAKIMI ÖN SOL RB288138	Ağırlık : 1,077 kg / 2.374 lb Rotbaşı : VW2009 Rotmili : VW3009	
	SK4005 Z ROT ÖM SAĞ-SOL L=335MM	Ağırlık : 0,322 kg / 0.710 lb Malzeme Türü : Metal Uzunluk : 335 mm / 13.19 inch Aşık Diş Çapı : M12X1,5	5Q0411315B
	AU6010 SALINCAK ÜST SOL VE SAĞ RA5155	Ağırlık : 1,298 kg / 2.862 lb Malzeme Türü : Sac Metal	1K0505323H, 1K0505323N
	AU9003 SALINCAK ARKA ALT SAĞ	Ağırlık : 1,733 kg / 3.821 lb Malzeme Türü : Sac Metal	3C0505224D
	AU9004 SALINCAK ARKA ALT SOL	Ağırlık : 1,733 kg / 3.821 lb Malzeme Türü : Sac Metal	3C0505223DÂ , 3C0505223D
	AU9037 SALINCAK ARKA ALT SAĞ SAC LEVHA	Ağırlık : 1,735 kg / 3.825 lb Malzeme Türü : Sac Metal	3C0505224E
	AU9038 SALINCAK VE DENGİ KOLU ARKA ALT SOL SAC LEVHA	Ağırlık : 1,735 kg / 3.825 lb Malzeme Türü : Sac Metal	3C0505223E
	SK9001 SALINCAK ARKA ALT	Ağırlık : 0,701 kg / 1.545 lb Malzeme Türü : Sac Metal	1K0501529J
	VW6018 SALINCAK ÖN SAĞ RB30219	Ağırlık : 4,85 kg / 10.692 lb Malzeme Türü : Döküm Çelik	1K0407152AC*, 1K0407152M* 1K0407152P, 1K0407152Q 1K0407152R*
	VW6019 SALINCAK ÖN SOL RB30218	Ağırlık : 4,85 kg / 10.692 lb Malzeme Türü : Döküm Çelik	1K0407151AC*, 1K0407151AC 1K0407151M*, 1K0407151M 1K0407151R*, 1K0407151R











* Bu sayfada ve katalogdaki tüm araçların adları, markaları, modelleri, sembolleri, logoları, orjinal numaraları (oe) ve diğer üçüncü parti numaraları sadece referans amaçlı kullanılmaktadır.

TIGUAN
I 5N
2007 - 2016

Resim	Ürün Kodu ve Açıklaması	Detay	OEM
	VW6032 SALINCAK ÖN SAĞ RD1051	Ağırlık : 3,441 kg / 7.586 lb Malzeme Türü : Alüminyum	3C0407151A, 3C0407151B 3C0407151E, 3C0407151G*
	VW6032J SALINCAK ÖN RD1050	Ağırlık : 2,9 kg / 6.393 lb Malzeme Türü : Alüminyum	3C0407151A, 3C0407151B 3C0407151E, 3C0407151G 3C0407151H
	VW6033 SALINCAK ÖN SOL RD1052	Ağırlık : 3,441 kg / 7.586 lb Malzeme Türü : Alüminyum	3C0407151A, 3C0407151B 3C0407151E, 3C0407151H*
	VW6059 SALINCAK ÖN ALT SAĞ	Ağırlık : 3,490 kg / 7.694 lb Malzeme Türü : Alüminyum	3C0407152A, 3C0407152B 3C0407152E
	VW6060 SALINCAK ALT SOL	Ağırlık : 3,490 kg / 7.694 lb Malzeme Türü : Alüminyum	3C0407151A, 3C0407151B 3C0407151E
	VW9001 SALINCAK ARKA	Ağırlık : 2,55 kg / 5.622 lb Malzeme Türü : Sac Metal	1K0505311AA, 1K0505311ABÂ 1K0505311H, 1K0505311S 1K0505311T
	AU11014 SALINCAK VE DENGELİ KOLU BURCU ARKA SOL VE SAĞ	Şasi (Ön / Arka) : ARKA Yön : Sol Ve Sağ Ağırlık : 0,192 kg / 0.423 lb	1K0505543A
	AU11035 SALINCAK VE DENGELİ KOLU BURCU ARKA SOL VE SAĞ	Şasi (Ön / Arka) : ARKA Yön : Sol Ve Sağ Ağırlık : 0,25 kg / 0.551 lb	1K0505171C
	AU11088 SALINCAK VE DENGELİ KOLU BURCU ARKA	Şasi (Ön / Arka) : ARKA Ağırlık : 0,165 kg / 0.364 lb	1K0505541C, 1K0505541D 3C0505541
	SK11009 SALINCAK VE DENGELİ KOLU BURCU ARKA SOL VE SAĞ	Şasi (Ön / Arka) : ARKA Yön : Sol Ve Sağ Ağırlık : 0,176 kg / 0.388 lb	1K0501529J*
	SK11010 SALINCAK VE DENGELİ KOLU BURCU ARKA SOL VE SAĞ	Şasi (Ön / Arka) : ARKA Yön : Sol Ve Sağ Ağırlık : 0,196 kg / 0.432 lb Not : BÜYÜK	1K0501529J*



* Bu sayfada ve katalogdaki tüm araçların adları, markaları, modelleri, sembolleri, logoları, orijinal numaraları (oe) ve diğer üçüncü parti numaraları sadece referans amaçlı kullanılmaktadır.

TIGUAN
I 5N
2007 - 2016

Resim	Ürün Kodu ve Açıklaması	Detay	OEM
	VW11037 SALINCAK VE DENGE KOLU BURCU SOL VE SAĞ	Yön : Sol Ve Sağ Ağırlık : 0.11 kg / 0.243 lb	1K0505279A
	VW11042 SALINCAK VE DENGE KOLU BURCU ORTA SOL VE SAĞ	Yön : Orta Sol Ve Sağ Ağırlık : 0,182 kg / 0.401 lb	1K0407182, 5Q0407182
	VW11046 SALINCAK VE DENGE KOLU BURCU SAĞ B40133	Yön : Sağ Ağırlık : 0,6 kg / 1.323 lb	3C0199231A, 3C0199231B 3C0199231D
	VW11046B SALINCAK VE DENGE KOLU BURCU SAĞ	Yön : Sağ Ağırlık : 0.445 kg / 0.981 lb Not : BURÇ GÖVDESİ	3C0199231A, 3C0199231B 3C0199231D
	VW11051 SALINCAK VE DENGE KOLU BURCU SOL VE SAĞ	Yön : Sol Ve Sağ Ağırlık : 0.121 kg / 0.267 lb	6Q0407183, 6Q0407183A
	VW12159 TAŞIYICI DESTEK BURÇLARI ARKA SOL VE SAĞ	Şasi (Ön / Arka) : ARKA Yön : Sol Ve Sağ Ağırlık : 0,130 kg / 0.287 lb	1K0505553, 1K0505553A
	AU12024 TORSİYON BURCU ARKA SOL VE SAĞ	Şasi (Ön / Arka) : ARKA Yön : Sol Ve Sağ Ağırlık : 0.557 kg / 1.228 lb	1K0505145F, 1K0505145H 1K0505145K
	SK12003 VİRAJ DEMİR LASTİĞİ SOL VE SAĞ RUBBER	Şasi (Ön / Arka) : ÖN Yön : Sol Ve Sağ Ağırlık : 0,075 kg / 0.165 lb Malzeme Türü : Rubber	1K0411303, 1K0411303AL* 1K0411303BK, 1K0411314 3C0411303AA*, 3C0411303T*
	SK12003K VİRAJ DEMİR LASTİĞİ SOL VE SAĞ RUBBER	Şasi (Ön / Arka) : ÖN Yön : Sol Ve Sağ Ağırlık : 0,150 kg / 0.331 lb Malzeme Türü : Rubber	1K0411303, 1K0411303AL* 1K0411303BK, 1K0411314 3C0411303AA*, 3C0411303T*
	VW12017 AMORTİSÖR TAKOZU SOL VE SAĞ AMORTİSÖR TAKOZU	Yön : Sol Ve Sağ Ağırlık : 0.847 kg / 1.867 lb Not : AMORTİSÖR TAKOZU	1K0412331B, 1K0412331C
	VW12109 AMORTİSÖR TAKOZU SOL VE SAĞ AMORTİSÖR RULMANI	Yön : Sol Ve Sağ Ağırlık : 0.26 kg / 0.573 lb Not : AMORTİSÖR RULMANI	6N0412249C, 6N0412249E

* Bu sayfada ve katalogdaki tüm araçların adları, markaları, modelleri, sembolleri, logoları, orjinal numaraları (oe) ve diğer üçüncü parti numaraları sadece referans amaçlı kullanılmaktadır.

TIGUAN
I 5N
2007 - 2016









Resim	Ürün Kodu ve Açıklaması	Detay	OEM
	VW12109K AMORTİSÖR TAKOZU SOL VE SAĞ 2 PCS	Yön : Sol Ve Sağ Ağırlık : 0.52 kg / 1.146 lb Not : 2 PCS	6N0412249C, 6N0412249E
	AU12021 MOTOR TAKOZU SOL VE SAĞ MOTOR TAKOZU	Yön : Sol Ve Sağ Ağırlık : 0.6 kg / 1.323 lb Malzeme Türü : Motor Takozu	5N0199855B, 5N0199855C 5N0199855E
	VW12097 MOTOR TAKOZU SOL VE SAĞ MOTOR TAKOZU	Yön : Sol Ve Sağ Ağırlık : 0.251 kg / 0.553 lb Not : MOTOR TAKOZU	1K0199868, 1K0199868A 1K0199868C, 1K0199868P 1K0199868Q
	VW12105 MOTOR TAKOZU SOL VE SAĞ MOTOR TAKOZU ARKA	Yön : Sol Ve Sağ Ağırlık : 0.564 kg / 1.243 lb Not : MOTOR TAKOZU ARKA	3C0199855, 3C0199855H 3C0199855M
	VW12134 MOTOR TAKOZU ÖN SOL	Şasi (Ön / Arka) : ÖN Yön : Sol Ağırlık : 2,145 kg / 4.729 lb	5N0199262D, 5N0199262M 5N0199262N
	VW12038 SÜSPANSİYON TAKOZU SOL VE SAĞ SUS. ARA YATAK TAKOZ ARKA	Yön : Sol Ve Sağ Ağırlık : 0.12 kg / 0.265 lb Not : SUS. ARA YATAK TAKOZ ARKA	3C0 511 359, 3C0511359
	VW12051 SÜSPANSİYON TAKOZU SOL VE SAĞ LASTİK DAYANAK SÜSPANSİYON	Yön : Sol Ve Sağ Ağırlık : 0.045 kg / 0.099 lb Not : LASTİK DAYANAK SÜSPANSİYON	1K0412303B
	VW12086 RADYATÖR TAKOZU SOL VE SAĞ RADYATÖR ÜST LASTİĞİ	Yön : Sol Ve Sağ Ağırlık : 0.024 kg / 0.053 lb Not : RADYATÖR ÜST LASTİĞİ	1K0121367F
	VW13006 DİREKSİYON KÖRÜĞÜ	Ağırlık : 0.145 kg / 0.320 lb	1K0423831A, 5C0423831
	VW13006K DİREKSİYON KÖRÜĞÜ SOL VE SAĞ 2 PİECES	Ağırlık : 0.29 kg / 0.639 lb	1K0423831A, 5C0423831
	VW14003 AKS KÖRÜĞÜ +KELEPÇE+YAĞ. DIŞ	Ağırlık : 0.25 kg / 0.551 lb	1K0 498 203, 1K0498203

* Bu sayfada ve katalogdaki tüm araçların adları, markaları, modelleri, sembolleri, logoları, orjinal numaraları (oe) ve diğer üçüncü parti numaraları sadece referans amaçlı kullanılmaktadır.

TIGUAN
I 5N
2007 - 2016











Resim	Ürün Kodu ve Açıklaması	Detay	OEM
	AU15001 AMORTİSÖR KÖRÜĞÜ ÖN	Şasi (Ön / Arka) : ÖN Ağırlık : 0,110 kg / 0.243 lb	6N0413175A

TIGUAN
II AD1
2016 - 2023

Resim	Ürün Kodu ve Açıklaması	Detay	OEM
	VW1019 ROTİL ÖN SAĞ Ø15,3 RB2538	Ağırlık : 0,555 kg / 1.224 lb Konik Ölçüsü : Ø15,3 Bağlantı Delik Çapı : Ø10,5 Aşık Diş Çapı : M12X1,5	3C0407366A
	VW1020 ROTİL ÖN SOL Ø15,3 RB2539	Ağırlık : 0,555 kg / 1.224 lb Konik Ölçüsü : Ø15,3 Bağlantı Delik Çapı : Ø10,5 Aşık Diş Çapı : M12X1,5	3C0407365A
	VW2033 ROTBAŞI SAĞ	Ağırlık : 0,525 kg / 1.157 lb	5WA423812E
	VW2034 ROTBAŞI SOL	Ağırlık : 0,525 kg / 1.157 lb	5WA423811E
	VW4014 Z ROT ÖN SAĞ-SOL METAL 335 RB2935	Ağırlık : 0,46 kg / 1.014 lb Malzeme Türü : Metal Uzunluk : 335 mm / 13.19 inch Aşık Diş Çapı : M12X1,5	1K0411315B, 1K0411315D 1K0411315J, 1K0411315K 1K0411315R, 5Q0411315A 5Q0411315B
	SK9002 SALINCAK ALT SOL VE SAĞ	Ağırlık : 2,914 kg / 6.424 lb Malzeme Türü : Sac Metal	3Q0505311C, 3Q0505311D 3Q0505311E
	VW6055 SALINCAK ÖN ALT SAĞ	Ağırlık : 3,768 kg / 8.307 lb Malzeme Türü : Sac Metal	3Q0407152E*, 3Q0407152E 3Q0407152F*, 3Q0407152F 3Q0407154B*, 3Q0407154B
	VW6055J SALINCAK ÖN ALT SAĞ	Malzeme Türü : Sac Metal	3Q0407152E, 3Q0407152F 3Q0407154B
	VW6056 SALINCAK ÖN ALT SOL	Ağırlık : 3,768 kg / 8.307 lb Malzeme Türü : Sac Metal	3Q0407151E*, 3Q0407151E 3Q0407151F*, 3Q0407151F 3Q0407153B*, 3Q0407153B





* Bu sayfada ve katalogdaki tüm araçların adları, markaları, modelleri, sembolleri, logoları, orjinal numaraları (oe) ve diğer üçüncü parti numaraları sadece referans amaçlı kullanılmaktadır.

TIGUAN
II AD1
2016 - 2023







Resim	Ürün Kodu ve Açıklaması	Detay	OEM
	VW6056J SALINCAK ÖN ALT SOL	Malzeme Türü : Sac Metal	3Q0407151E, 3Q0407151F 3Q0407153B
	VW9005 SALINCAK ARKA ALT ÖNDEN	Ağırlık : 0,566 kg / 1.248 lb Malzeme Türü : Sac Metal	5Q0501529C, 5Q0501529D 5Q0501529E, 5Q0501529F
	VW9008 SALINCAK SAĞ	Ağırlık : 1,110 kg / 2.447 lb Malzeme Türü : Sac Metal	5QF505224C
	VW9009 SALINCAK SOL	Ağırlık : 1,110 kg / 2.447 lb Malzeme Türü : Sac Metal	5QF505223C
	SK11006 SALINCAK VE DENGE KOLU BURCU ARKA ALT	Şasi (Ön / Arka) : ARKA Yön : Alt Ağırlık : 0,125 kg / 0.276 lb	3Q0505311C*, 3Q0505311D* 3Q0505311E*, 5Q0505171B*
	VW11042 SALINCAK VE DENGE KOLU BURCU ORTA SOL VE SAĞ	Yön : Orta Sol Ve Sağ Ağırlık : 0,182 kg / 0.401 lb	1K0407182, 5Q0407182
	VW11063 SALINCAK VE DENGE KOLU BURCU SOL VE SAĞ	Yön : Sol Ve Sağ Ağırlık : 0.34 kg / 0.750 lb	5Q0407183D, 5Q0407183E
	VW11075 SALINCAK VE DENGE KOLU BURCU ARKA SOL VE SAĞ	Şasi (Ön / Arka) : ARKA Yön : Sol Ve Sağ Ağırlık : 0,870 kg / 1.918 lb Not : FORWARD and INNER	Part of 5Q0501529C, Part of 5Q0501529D Part of 5Q0501529E, Part of 5Q0501529F
	VW11076 SALINCAK VE DENGE KOLU BURCU ARKA SOL VE SAĞ	Şasi (Ön / Arka) : ARKA Yön : Sol Ve Sağ Ağırlık : 0,870 kg / 1.918 lb Not : FORWARD and OUTER	Part of 5Q0501529C, Part of 5Q0501529D Part of 5Q0501529E, Part of 5Q0501529F
	AU12022 MOTOR TAKOZU SOL VE SAĞ MOTOR TAKOZU	Yön : Sol Ve Sağ Ağırlık : 1.58 kg / 3.483 lb Malzeme Türü : Motor Takoğu	5Q0199262, 5Q0199262BH 5Q0199262DE
	AU12023 MOTOR TAKOZU SOL VE SAĞ MOTOR TAKOZU 7 İLERİ	Yön : Sol Ve Sağ Ağırlık : 1.58 kg / 3.483 lb Malzeme Türü : Motor Takoğu Not : 7 İLERİ	5Q0199262BE, 5Q0199262BF

* Bu sayfada ve katalogdaki tüm araçların adları, markaları, modelleri, sembolleri, logoları, orjinal numaraları (oe) ve diğer üçüncü parti numaraları sadece referans amaçlı kullanılmaktadır.

TIGUAN
II AD1
2016 - 2023







Resim	Ürün Kodu ve Açıklaması	Detay	OEM
	AU12026 MOTOR TAKOZU ÖN SOL VE SAĞ	Şasi (Ön / Arka) : ÖN Yön : Sol Ve Sağ Ağırlık : 0,850 kg / 1.874 lb	5Q0199855AD, 5Q0199855J 5Q0199855P, 5Q0199855Q
	VW12086 RADYATÖR TAKOZU SOL VE SAĞ RADYATÖR ÜST LASTİĞİ	Yön : Sol Ve Sağ Ağırlık : 0.024 kg / 0.053 lb Not : RADYATÖR ÜST LASTİĞİ	1K0121367F
	VW13006 DİREKSİYON KÖRÜĞÜ	Ağırlık : 0.145 kg / 0.320 lb	1K0423831A, 5C0423831
	VW13006K DİREKSİYON KÖRÜĞÜ SOL VE SAĞ 2 PİECES	Ağırlık : 0.29 kg / 0.639 lb	1K0423831A, 5C0423831

TIGUAN
III
2023 -



Resim	Ürün Kodu ve Açıklaması	Detay	OEM
	VW1031 ROTİL ÖN ALT SAĞ Ø15,2	Ağırlık : 0,59 kg / 1.301 lb Konik Ölçüsü : Ø15,2 Aşık Diş Çapı : M12X1,5	3C0407366B
	VW1032 ROTİL ÖN ALT SOL Ø15,2	Ağırlık : 0,59 kg / 1.301 lb Konik Ölçüsü : Ø15,2 Aşık Diş Çapı : M12X1,5	3C0407365B
	VW2033 ROTBAŞI SAĞ	Ağırlık : 0,525 kg / 1.157 lb	5WA423812E
	VW2034 ROTBAŞI SOL	Ağırlık : 0,525 kg / 1.157 lb	5WA423811E
	VW4014 Z ROT ÖN SAĞ-SOL METAL 335 RB2935	Ağırlık : 0,46 kg / 1.014 lb Malzeme Türü : Metal Uzunluk : 335 mm / 13.19 inch Aşık Diş Çapı : M12X1,5	1K0411315B, 1K0411315D 1K0411315J, 1K0411315K 1K0411315R, 5Q0411315A 5Q0411315B
	VW4035 Z ROT ARKA PLASTİK	Ağırlık : 0,165 kg / 0.364 lb Malzeme Türü : Plastik Uzunluk : 111 mm / 4.37 inch	5WA505465A

* Bu sayfada ve katalogdaki tüm araçların adları, markaları, modelleri, sembolleri, logoları, orjinal numaraları (oe) ve diğer üçüncü parti numaraları sadece referans amaçlı kullanılmaktadır.

TIGUAN
III
2023 -











Resim	Ürün Kodu ve Açıklaması	Detay	OEM
	VW6055J SALINCAK ÖN ALT SAĞ	Malzeme Türü : Sac Metal	3Q0407152E, 3Q0407152F 3Q0407154B
	VW6056J SALINCAK ÖN ALT SOL	Malzeme Türü : Sac Metal	3Q0407151E, 3Q0407151F 3Q0407153B
	VW9004 SALINCAK ARKA	Ağırlık : 1,3 kg / 2.866 lb Malzeme Türü : Sac Metal	5Q0505323C, 5Q0505323D
	VW11037 SALINCAK VE DENGE KOLU BURCU SOL VE SAĞ	Yön : Sol Ve Sağ Ağırlık : 0.11 kg / 0.243 lb	1K0505279A
	VW11042 SALINCAK VE DENGE KOLU BURCU ORTA SOL VE SAĞ	Yön : Orta Sol Ve Sağ Ağırlık : 0,182 kg / 0.401 lb	1K0407182, 5Q0407182
	VW11056 SALINCAK VE DENGE KOLU BURCU ARKA SOL VE SAĞ	Şasi (Ön / Arka) : ARKA Yön : Sol Ve Sağ Ağırlık : 0.13 kg / 0.287 lb	1K0505203A, 1K0505323D 1K0505323G, 1K0505323H 1K0505323N, 5Q0505323C
	VW11063 SALINCAK VE DENGE KOLU BURCU SOL VE SAĞ	Yön : Sol Ve Sağ Ağırlık : 0.34 kg / 0.750 lb	5Q0407183D, 5Q0407183E

TOUAREG
7LA, 7L6, 7L7
2002 - 2010

Resim	Ürün Kodu ve Açıklaması	Detay	OEM
	VW2001 ROTBAŞI SAĞ RD0347	Ağırlık : 0,87 kg / 1.918 lb Uzunluk : 180 mm / 7.09 inch Gövde Diş Çapı : M14X2 Aşık Diş Çapı : M12X1,75 Aşık Konik Çapı : Ø13,2	7L0422818B, 7L0422818C 7L0422818D, 95534713220
	VW2002 ROTBAŞI SOL RD0346	Ağırlık : 0,87 kg / 1.918 lb Uzunluk : 93 mm / 3.66 inch Gövde Diş Çapı : M16X1,5 Aşık Diş Çapı : M14X1,5 Aşık Konik Çapı : Ø16,6	7L0422817B, 7L0422817C 7L0422817D, 95534713221
	VW3001 ROTMİLİ SAĞ-SOL 288 RD08226	Ağırlık : 0,692 kg / 1.526 lb Uzunluk : 288 mm / 11.34 inch Gövde Diş Çapı : M16X1,5 Aşık Diş Çapı : M16X1,5	1160310016, 7L0422803B 7L0422803C, 7L0422804B 7L0422804C, 7L0422821 7L0422821B, 7L0422821D

* Bu sayfada ve katalogdaki tüm araçların adları, markaları, modelleri, sembolleri, logoları, orjinal numaraları (oe) ve diğer üçüncü parti numaraları sadece referans amaçlı kullanılmaktadır.

TOUAREG
7LA, 7L6, 7L7
2002 - 2010

Resim	Ürün Kodu ve Açıklaması	Detay	OEM
	VW20013001 ROT TAKIMI ÖN AKS SAĞ	Ağırlık : 1,285 kg / 2.833 lb Rotbaşı : VW2001 Rotmilii : VW3001	7L0422804B, 7L0422804C 7L0422804D, 955347032021
	VW20023001 ROT TAKIMI ÖN AKS SOL	Ağırlık : 1,27 kg / 2.800 lb Rotbaşı : VW2002 Rotmilii : VW3001	7L0422803B, 7L0422803C 7L0422803D, 955347032020
	AU4042 Z ROT SAĞ METAL	Ağırlık : 0,533 kg / 1.175 lb Malzeme Türü : Metal Uzunluk : 200 mm / 7.87 inch Not : CHASSIS NO FROM 4L8030301	7L0505466C, 7L0505466D 95533307021
	AU4043 Z ROT SOL METAL	Ağırlık : 0,533 kg / 1.175 lb Malzeme Türü : Metal Uzunluk : 200 mm / 7.87 inch Not : CHASSIS NO FROM 4L8030301	7L0505465C, 7L0505465D 95533306921
	VW4002 Z ROT ARKA SAĞ 201 RD0943	Ağırlık : 0,535 kg / 1.179 lb Malzeme Türü : Metal Uzunluk : 201 mm / 7.91 inch Aşık Dış Çapı : M12X1,5	7L0505466A, 95533307010
	VW4003 Z ROT ARKA SOL 201 RD0944	Ağırlık : 0,534 kg / 1.177 lb Malzeme Türü : Metal Uzunluk : 201 mm / 7.91 inch Aşık Dış Çapı : M12X1,5	7L0505465A, 7L0505465B 95533306910, 95533306921 95533307011
	AU6015 SALINCAK ARKA ÜST SOL	Ağırlık : 1,09 kg / 2.403 lb Malzeme Türü : Alüminyum	7L0505397, 7L0505398
	AU6016 SALINCAK ARKA ÜST SAĞ	Ağırlık : 1,09 kg / 2.403 lb Malzeme Türü : Alüminyum	7L0505397, 7L0505398
	AU9005 SALINCAK ARKA	Ağırlık : 1,36 kg / 2.998 lb Malzeme Türü : Sac Metal	7L8501529, 7L8501529A 95533104530, 95533104531 95533104532
	VW5003 SALINCAK ÖN	Ağırlık : 0,230 kg / 0.507 lb Malzeme Türü : Alüminyum	7L0411317, 95534306900
	VW5004 SALINCAK ARKA ÜST	Ağırlık : 0,860 kg / 1.896 lb Malzeme Türü : Alüminyum	7L0505323A, 95533104710









* Bu sayfada ve katalogdaki tüm araçların adları, markaları, modelleri, sembolleri, logoları, orjinal numaraları (oe) ve diğer üçüncü parti numaraları sadece referans amaçlı kullanılmaktadır.

TOUAREG
7LA, 7L6, 7L7
2002 - 2010

Resim	Ürün Kodu ve Açıklaması	Detay	OEM
	VW6027 SALINCAK ÖN ÜST RB3017	Ağırlık : 1,1 kg / 2.425 lb Malzeme Türü : Alüminyum	7L0407021, 7L0407021A 7L0407021B, 95534102701 95534102702
	VW6028 SALINCAK ÖN ALT SAĞ RD1048	Ağırlık : 10,302 kg / 22.712 lb Malzeme Türü : Döküm Çelik	7L0407152C, 7L0407152D 7L0407152E, 7L0407152H 95534101830, 95534101831 95534101832, 95534101833
	VW6029 SALINCAK ÖN ALT SOL RD1049	Ağırlık : 10,302 kg / 22.712 lb Malzeme Türü : Döküm Çelik	7L0407151C, 7L0407151D 7L0407151E, 7L0407151H 95534101730, 95534101731 95534101733
	VW6067 SALINCAK ALT SAĞ	Ağırlık : 8,834 kg / 19.476 lb Malzeme Türü : Döküm Çelik	7L0407152F, 7L0407152J 7L0407152K, 95534101860 95534101861
	VW6068 SALINCAK ALT SOL	Ağırlık : 8,834 kg / 19.476 lb Malzeme Türü : Döküm Çelik	7L0407151F, 7L0407151J 7L0407151K, 95534101760 95534101761
	AU11020 SALINCAK VE DENGE KOLU BURCU ÖN ALT SOL VE SAĞ	Şasi (Ön / Arka) : ÖN Yön : Alt Sol Ve Sağ Ağırlık : 0,22 kg / 0.485 lb	7L0407183, 7L0407183A 95534158810
	AU11026 SALINCAK VE DENGE KOLU BURCU ÖN ORTA SOL VE SAĞ	Şasi (Ön / Arka) : ÖN Yön : Orta Sol Ve Sağ Ağırlık : 0,272 kg / 0.600 lb	7L0412333A
	AU11037 SALINCAK VE DENGE KOLU BURCU ARKA SOL VE SAĞ	Şasi (Ön / Arka) : ARKA Yön : Sol Ve Sağ Ağırlık : 0,222 kg / 0.489 lb Not : DENGE KOLU BURCU	7L8501529A-P
	AU11063 SALINCAK VE DENGE KOLU BURCU SOL VE SAĞ	Yön : Sol Ve Sağ Ağırlık : 0.18 kg / 0.397 lb	7L0505397*, 7L0505398* part of 7L0505397
	AU11064 SALINCAK VE DENGE KOLU BURCU SOL VE SAĞ	Yön : Sol Ve Sağ Ağırlık : 0.278 kg / 0.613 lb	7L0501537B, 7L0505397* 7L0505397, 7L0505397SK 7L0505398*, 7L0505398 7L0505398SK, 7L8501529A 7L8501529ASK, part of 7L0505397
	AU11067 SALINCAK VE DENGE KOLU BURCU ARKA SOL VE SAĞ	Şasi (Ön / Arka) : ARKA Yön : Sol Ve Sağ Not : DENGE KOLU BURCU	7L8501529A-P

* Bu sayfada ve katalogdaki tüm araçların adları, markaları, modelleri, sembolleri, logoları, orjinal numaraları (oe) ve diğer üçüncü parti numaraları sadece referans amaçlı kullanılmaktadır.

TOUAREG
7LA, 7L6, 7L7
2002 - 2010





Resim	Ürün Kodu ve Açıklaması	Detay	OEM
	VW11026 SALINCAK VE DENGE KOLU BURCU SOL VE SAĞ	Yön : Sol Ve Sağ Ağırlık : 0,25 kg / 0.551 lb	7L0407182C, 7L0407182E 95534124203
	VW11032 SALINCAK VE DENGE KOLU BURCU SOL VE SAĞ	Yön : Sol Ve Sağ Ağırlık : 0,34 kg / 0.750 lb	7L0407182D, 7L0407182F 7L0407182G
	VW11038 SALINCAK VE DENGE KOLU BURCU ÜST SOL VE SAĞ	Yön : Üst Sol Ve Sağ Ağırlık : 0,16 kg / 0.353 lb Not : ARKA DENGE KOL BURCU DÜZ	7L0505323A, 7L0505553
	VW11039 SALINCAK VE DENGE KOLU BURCU ARKA SOL VE SAĞ	Şasi (Ön / Arka) : ARKA Yön : Sol Ve Sağ Ağırlık : 0,12 kg / 0.265 lb Not : ARKA DENGE KOL BURCU 12MM	7L0505554
	VW11048 SALINCAK VE DENGE KOLU BURCU SOL VE SAĞ	Yön : Sol Ve Sağ Ağırlık : 0,262 kg / 0.578 lb	7L0411317 (p), 7L0411317-P
	VW11061 SALINCAK VE DENGE KOLU BURCU ÜST SOL VE SAĞ	Yön : Üst Sol Ve Sağ Ağırlık : 0,178 kg / 0.392 lb	7L0407021A, 7L0407021B 7L0407077
	VW12116 VİRAJ DEMİR LASTİĞİ SOL VE SAĞ RUBBER	Şasi (Ön / Arka) : ÖN Yön : Sol Ve Sağ Ağırlık : 0,05 kg / 0.110 lb Malzeme Türü : Rubber Not : VİRAJ LASTİĞİ (ÖN)	7L0411313G, 7L0411313H
	VW12116K VİRAJ DEMİR LASTİĞİ SOL VE SAĞ RUBBER	Şasi (Ön / Arka) : ÖN Yön : Sol Ve Sağ Ağırlık : 0,1 kg / 0.220 lb Malzeme Türü : Rubber	7L0411313G*, 7L0411313H*
	AU12030 MOTOR TAKOZU ÖN	Şasi (Ön / Arka) : ÖN Ağırlık : 1,510 kg / 3.329 lb	7L8199131, 7L8199131A 95537504900
	AU12047 ŞANZIMAN TAKOZU ARKA	Şasi (Ön / Arka) : ARKA Ağırlık : 0,473 kg / 1.043 lb	7L0399249B, 7L6399225F 7L6399225Q
	VW12121 ŞAFT TAKOZU ÖN ŞAFT ASKI TAKOZU	Şasi (Ön / Arka) : ÖN Ağırlık : 0,9 kg / 1.984 lb Malzeme Türü : Şaft Askı Takozu	7L0521403, 7L6521403 95542101000, 95542102021

* Bu sayfada ve katalogdaki tüm araçların adları, markaları, modelleri, sembolleri, logoları, orijinal numaraları (oe) ve diğer üçüncü parti numaraları sadece referans amaçlı kullanılmaktadır.

TOUAREG
7LA, 7L6, 7L7
2002 - 2010











Resim	Ürün Kodu ve Açıklaması	Detay	OEM
	VW12121Â ŞAFT TAKOZU SOL VE SAĞ VW12121	Yön : Sol Ve Sağ	7L0521403, 7L6521403 95542101000, 95542102021
	AU12036 SÜSPANSİYON TAKOZU ARKA	Şasi (Ön / Arka) : ARKA Ağırlık : 0,135 kg / 0.298 lb	7L0512131B, 95533310520
	RN14016 AKS KÖRÜĞÜ +KELEPÇE+YAĞ. DIŞ	Ağırlık : 0.26 kg / 0.573 lb	7701209568, 7H0498103E 7H0498202A

TOUAREG
7P5
2010 - 2018

Resim	Ürün Kodu ve Açıklaması	Detay	OEM
	VW2001 ROTBAŞI SAĞ RD0347	Ağırlık : 0,87 kg / 1.918 lb Uzunluk : 180 mm / 7.09 inch Gövde Diş Çapı : M14X2 Aşık Diş Çapı : M12X1,75 Aşık Konik Çapı : Ø13,2	7L0422818B, 7L0422818C 7L0422818D, 95534713220
	VW2002 ROTBAŞI SOL RD0346	Ağırlık : 0,87 kg / 1.918 lb Uzunluk : 93 mm / 3.66 inch Gövde Diş Çapı : M16X1,5 Aşık Diş Çapı : M14X1,5 Aşık Konik Çapı : Ø16,6	7L0422817B, 7L0422817C 7L0422817D, 95534713221
	VW3001 ROTMİLİ SAĞ-SOL 288 RD08226	Ağırlık : 0,692 kg / 1.526 lb Uzunluk : 288 mm / 11.34 inch Gövde Diş Çapı : M16X1,5 Aşık Diş Çapı : M16X1,5	1160310016, 7L0422803B 7L0422803C, 7L0422804B 7L0422804C, 7L0422821 7L0422821B, 7L0422821D
	VW20013001 ROT TAKIMI ÖN AKS SAĞ	Ağırlık : 1,285 kg / 2.833 lb Rotbaşı : VW2001 Rotmili : VW3001	7L0422804B, 7L0422804C 7L0422804D, 955347032021
	VW20023001 ROT TAKIMI ÖN AKS SOL	Ağırlık : 1,27 kg / 2.800 lb Rotbaşı : VW2002 Rotmili : VW3001	7L0422803B, 7L0422803C 7L0422803D, 955347032020
	AU4042 Z ROT SAĞ METAL	Ağırlık : 0,533 kg / 1.175 lb Malzeme Türü : Metal Uzunluk : 200 mm / 7.87 inch Not : CHASSIS NO FROM 4L8030301	7L0505466C, 7L0505466D 95533307021
	AU4043 Z ROT SOL METAL	Ağırlık : 0,533 kg / 1.175 lb Malzeme Türü : Metal Uzunluk : 200 mm / 7.87 inch Not : CHASSIS NO FROM 4L8030301	7L0505465C, 7L0505465D 95533306921

* Bu sayfada ve katalogdaki tüm araçların adları, markaları, modelleri, sembolleri, logoları, orjinal numaraları (oe) ve diğer üçüncü parti numaraları sadece referans amaçlı kullanılmaktadır.

TOUAREG
7P5
2010 - 2018

Resim	Ürün Kodu ve Açıklaması	Detay	OEM
	VW4002 Z ROT ARKA SAĞ 201 RD0943	Ağırlık : 0,535 kg / 1.179 lb Malzeme Türü : Metal Uzunluk : 201 mm / 7.91 inch Aşık Diş Çapı : M12X1,5	7L0505466A, 95533307010
	VW4003 Z ROT ARKA SOL 201 RD0944	Ağırlık : 0,534 kg / 1.177 lb Malzeme Türü : Metal Uzunluk : 201 mm / 7.91 inch Aşık Diş Çapı : M12X1,5	7L0505465A, 7L0505465B 95533306910, 95533306921 95533307011
	AU6015 SALINCAK ARKA ÜST SOL	Ağırlık : 1,09 kg / 2.403 lb Malzeme Türü : Alüminyum	7L0505397, 7L0505398
	AU6016 SALINCAK ARKA ÜST SAĞ	Ağırlık : 1,09 kg / 2.403 lb Malzeme Türü : Alüminyum	7L0505397, 7L0505398
	AU6021 SALINCAK ÖN SAĞ ALT	Ağırlık : 5,348 kg / 11.790 lb Malzeme Türü : Alüminyum	7P0407152B, 7P0407152C 7P0407152D, 7P0407152E 95834105403
	AU6022 SALINCAK ÖN SOL ALT	Ağırlık : 5,348 kg / 11.790 lb Malzeme Türü : Alüminyum	7P0407151B, 7P0407151C 7P0407151D, 7P0407151E 95834105303
	AU9005 SALINCAK ARKA	Ağırlık : 1,36 kg / 2.998 lb Malzeme Türü : Sac Metal	7L8501529, 7L8501529A 95533104530, 95533104531 95533104532
	VW5003 SALINCAK ÖN	Ağırlık : 0,230 kg / 0.507 lb Malzeme Türü : Alüminyum	7L0411317, 95534306900
	VW5004 SALINCAK ARKA ÜST	Ağırlık : 0,860 kg / 1.896 lb Malzeme Türü : Alüminyum	7L0505323A, 95533104710
	VW6077 SALINCAK VE DENGE KOLU ÖN ÜST ALÜMİNYUM	Ağırlık : 1,155 kg / 2.546 lb Malzeme Türü : Alüminyum	7P0407021, 95834105100
	VW9010 SALINCAK ALT SAĞ	Ağırlık : 1,170 kg / 2.579 lb Malzeme Türü : Sac Metal	7P0501530, 95833104500

* Bu sayfada ve katalogdaki tüm araçların adları, markaları, modelleri, sembolleri, logoları, orjinal numaraları (oe) ve diğer üçüncü parti numaraları sadece referans amaçlı kullanılmaktadır.

TOUAREG
7P5
2010 - 2018







Resim	Ürün Kodu ve Açıklaması	Detay	OEM
	VW9011 SALINCAK ALT SOL	Ağırlık : 1,170 kg / 2.579 lb Malzeme Türü : Sac Metal	7P0501529, 95833104600
	AU11020 SALINCAK VE DENGE KOLU BURCU ÖN ALT SOL VE SAĞ	Şasi (Ön / Arka) : ÖN Yön : Alt Sol Ve Sağ Ağırlık : 0,22 kg / 0.485 lb	7L0407183, 7L0407183A 95534158810
	AU11026 SALINCAK VE DENGE KOLU BURCU ÖN ORTA SOL VE SAĞ	Şasi (Ön / Arka) : ÖN Yön : Orta Sol Ve Sağ Ağırlık : 0,272 kg / 0.600 lb	7L0412333A
	AU11037 SALINCAK VE DENGE KOLU BURCU ARKA SOL VE SAĞ	Şasi (Ön / Arka) : ARKA Yön : Sol Ve Sağ Ağırlık : 0,222 kg / 0.489 lb Not : DENGE KOLU BURCU	7L8501529A-P
	AU11063 SALINCAK VE DENGE KOLU BURCU SOL VE SAĞ	Yön : Sol Ve Sağ Ağırlık : 0.18 kg / 0.397 lb	7L0505397*, 7L0505398* part of 7L0505397
	AU11064 SALINCAK VE DENGE KOLU BURCU SOL VE SAĞ	Yön : Sol Ve Sağ Ağırlık : 0.278 kg / 0.613 lb	7L0501537B, 7L0505397* 7L0505397, 7L0505397SK 7L0505398*, 7L0505398 7L0505398SK, 7L8501529A 7L8501529ASK, part of 7L0505397
	AU11067 SALINCAK VE DENGE KOLU BURCU ARKA SOL VE SAĞ	Şasi (Ön / Arka) : ARKA Yön : Sol Ve Sağ Not : DENGE KOLU BURCU	7L8501529A-P
	VW11032 SALINCAK VE DENGE KOLU BURCU SOL VE SAĞ	Yön : Sol Ve Sağ Ağırlık : 0.34 kg / 0.750 lb	7L0407182D, 7L0407182F 7L0407182G
	VW11038 SALINCAK VE DENGE KOLU BURCU ÜST SOL VE SAĞ	Yön : Üst Sol Ve Sağ Ağırlık : 0.16 kg / 0.353 lb Not : ARKA DENGE KOL BURCU DÜZ	7L0505323A, 7L0505553
	VW11039 SALINCAK VE DENGE KOLU BURCU ARKA SOL VE SAĞ	Şasi (Ön / Arka) : ARKA Yön : Sol Ve Sağ Ağırlık : 0.12 kg / 0.265 lb Not : ARKA DENGE KOL BURCU 12MM	7L0505554
	VW11048 SALINCAK VE DENGE KOLU BURCU SOL VE SAĞ	Yön : Sol Ve Sağ Ağırlık : 0,262 kg / 0.578 lb	7L0411317 (p), 7L0411317-P

* Bu sayfada ve katalogdaki tüm araçların adları, markaları, modelleri, sembolleri, logoları, orijinal numaraları (oe) ve diğer üçüncü parti numaraları sadece referans amaçlı kullanılmaktadır.

TOUAREG
7P5
2010 - 2018







Resim	Ürün Kodu ve Açıklaması	Detay	OEM
	VW11161 SALINCAK VE DENGE KOLU BURCU ÖN ÜST	Şasi (Ön / Arka) : ÖN Yön : Üst Ağırlık : 0,855 kg / 1.885 lb	7P0407021*, 95834105100*
	VW12116 VİRAJ DEMİR LASTİĐİ SOL VE SAĐ RUBBER	Şasi (Ön / Arka) : ÖN Yön : Sol Ve SaĐ Ağırlık : 0.05 kg / 0.110 lb Malzeme Türü : Rubber Not : VİRAJ LASTİĐİ (ÖN)	7L0411313G, 7L0411313H
	VW12116K VİRAJ DEMİR LASTİĐİ SOL VE SAĐ RUBBER	Şasi (Ön / Arka) : ÖN Yön : Sol Ve SaĐ Ağırlık : 0.1 kg / 0.220 lb Malzeme Türü : Rubber	7L0411313G*, 7L0411313H*

TOUAREG
CR7
2018 -





Resim	Ürün Kodu ve Açıklaması	Detay	OEM
	AU5075 SALINCAK ÜST ARKA TARAF SAĐ	Ağırlık : 0.55 kg / 1.213 lb Malzeme Türü : Alüminyum	4M0407510B, 4M0407510C 80A407510A
	AU5076 SALINCAK ÜST ARKA TARAF SOL	Ağırlık : 0.55 kg / 1.213 lb Malzeme Türü : Alüminyum	4M0407509B, 4M0407509C 80A407509A
	AU5077 SALINCAK ÜST ÖN TARAF SAĐ	Ağırlık : 0.56 kg / 1.235 lb Malzeme Türü : Alüminyum	4M0407506B, 4M0407506C 80A407506A
	AU5078 SALINCAK ÜST ÖN TARAF SOL	Ağırlık : 0.56 kg / 1.235 lb Malzeme Türü : Alüminyum	4M0407505B, 4M0407505C 80A407505A
	AU5081 SALINCAK ÜST ARKA TARAF SAĐ	Ağırlık : 3,143 kg / 6.929 lb Malzeme Türü : Alüminyum	4M0407694C, 4M0407694D 4M0407694E, 95840769400
	AU5082 SALINCAK ÜST ARKA TARAF SOL	Ağırlık : 3,143 kg / 6.929 lb Malzeme Türü : Alüminyum	4M0407693C, 4M0407693D 4M0407693E, 95840769300
	AU9029 SALINCAK ARKA ALT ARKADAN	Ağırlık : 0,811 kg / 1.788 lb Malzeme Türü : Alüminyum	4M0505323G

* Bu sayfada ve katalogdaki tüm araçların adları, markaları, modelleri, sembolleri, logoları, orjinal numaraları (oe) ve diĐer üçüncü parti numaraları sadece referans amaçlı kullanılmaktadır.

TOUAREG
CR7
2018 -











Resim	Ürün Kodu ve Açıklaması	Detay	OEM
	AU9031 SALINCAK VE DENGE KOLU ARKA ÜST SAĞ ALÜMİNYUM	Ağırlık : 1,545 kg / 3.406 lb Malzeme Türü : Alüminyum	4K0505398A, 4M0505398L
	AU9032 SALINCAK VE DENGE KOLU ARKA ÜST SOL ALÜMİNYUM	Ağırlık : 1,545 kg / 3.406 lb Malzeme Türü : Alüminyum	4K0505397A, 4M0505397L
	AU11071 SALINCAK VE DENGE KOLU BURCU ARKA ALT	Şasi (Ön / Arka) : ARKA Yön : Alt Ağırlık : 0,250 kg / 0.551 lb	4M0501529L*, 4M0501529N* 4M0501530N*
	AU11072 SALINCAK VE DENGE KOLU BURCU ARKA ALT	Şasi (Ön / Arka) : ARKA Yön : Alt Ağırlık : 0,250 kg / 0.551 lb	4M0501529L*, 4M0501529N* 4M0501530N*
	AU11073 SALINCAK VE DENGE KOLU BURCU ÖN ÜST	Şasi (Ön / Arka) : ÖN Yön : Üst Ağırlık : 0,620 kg / 1.367 lb	4M0407693C, 4M0407693D 4M0407693E, 4M0407694C 4M0407694D, 4M0407694E 95840769300, 95840769400
	AU11078 SALINCAK VE DENGE KOLU BURCU ARKA ARKA ÜST ARKADAN	Şasi (Ön / Arka) : ARKA Yön : Arka Üst Arkadan Ağırlık : 0,115 kg / 0.254 lb	8W0505397C*, 8W0505397F* 8W0505398C*, 8W0505398F*

TOURAN
1T1, 1T2
2003 - 2010

Resim	Ürün Kodu ve Açıklaması	Detay	OEM
	VW1014 ROTİL ÖN ALT SAĞ Ø15,6 RB2536	Ağırlık : 0,565 kg / 1.246 lb Konik Ölçüsü : Ø15,6 Bağlantı Delik Çapı : Ø10,5 Aşık Diş Çapı : M12X1,5	1K0407366B, 1K0407366C 1K0407366E, 5Q0407366A
	VW1015 ROTİL ÖN ALT SOL Ø15,6 RB2537	Ağırlık : 0,565 kg / 1.246 lb Konik Ölçüsü : Ø15,6 Bağlantı Delik Çapı : Ø10,5 Aşık Diş Çapı : M12X1,5	1K0407365B, 1K0407365C 1K0407365E, 5Q0407365A
	VW2008 ROTBAŞI ÖN SAĞ RD0342	Ağırlık : 0,412 kg / 0.908 lb Uzunluk : 95 mm / 3.74 inch Gövde Diş Çapı : M16X1,5 Aşık Diş Çapı : M12X1,5 Aşık Konik Çapı : Ø12,7	1K0423812A, 1K0423812C 1K0423812E, 1K0423812G 1K0423812J, 1K0423812K 1KD423812A
	VW2009 ROTBAŞI ÖN SOL RD0343	Ağırlık : 0,412 kg / 0.908 lb Uzunluk : 95 mm / 3.74 inch Gövde Diş Çapı : M16X1,5 Aşık Diş Çapı : M12X1,5 Aşık Konik Çapı : Ø13,5	1K0423811A, 1K0423811C 1K0423811E, 1K0423811G 1K0423811J, 1K0423811K 1KD423811A

* Bu sayfada ve katalogdaki tüm araçların adları, markaları, modelleri, sembolleri, logoları, orjinal numaraları (oe) ve diğer üçüncü parti numaraları sadece referans amaçlı kullanılmaktadır.

TOURAN
1T1, 1T2
2003 - 2010

Resim	Ürün Kodu ve Açıklaması	Detay	OEM
	VW3009 ROTMİLİ SAĞ-SOL 310 RB2838	Ağırlık : 0,665 kg / 1.466 lb Uzunluk : 311 mm / 12.24 inch Gövde Diş Çapı : M16X1,5 Aşık Diş Çapı : M16X1,5	1K0423810A
	VW20083009 ROT TAKIMI ÖN AKS SAĞ RB288137	Ağırlık : 1,078 kg / 2.377 lb Rotbaşı : VW2008 Rotmili : VW3009	
	VW20093009 ROT TAKIMI ÖN SOL RB288138	Ağırlık : 1,077 kg / 2.374 lb Rotbaşı : VW2009 Rotmili : VW3009	
	SK4005 Z ROT ÖM SAĞ-SOL L=335MM	Ağırlık : 0,322 kg / 0.710 lb Malzeme Türü : Metal Uzunluk : 335 mm / 13.19 inch Aşık Diş Çapı : M12X1,5	5Q0411315B
	VW4014 Z ROT ÖN SAĞ-SOL METAL 335 RB2935	Ağırlık : 0,46 kg / 1.014 lb Malzeme Türü : Metal Uzunluk : 335 mm / 13.19 inch Aşık Diş Çapı : M12X1,5	1K0411315B, 1K0411315D 1K0411315J, 1K0411315K 1K0411315R, 5Q0411315A 5Q0411315B
	VW4015 Z ROT SOL VE SAĞ METAL RB2937	Ağırlık : 0,373 kg / 0.822 lb Malzeme Türü : Metal Uzunluk : 95,5 mm / 3.76 inch Aşık Diş Çapı : M10X1,5	1K0505465C, 1K0505465D 1K0505465H, 1K0505465J 1K0505465K
	VW4015K Z ROT SOL VE SAĞ METAL	Ağırlık : 0,373 kg / 0.822 lb Malzeme Türü : Metal Uzunluk : 95,5 mm / 3.76 inch Aşık Diş Çapı : M10X1,5	1K0505465C, 1K0505465D 1K0505465H, 1K0505465J 1K0505465K
	VW4016 Z ROT ARKA METAL 243 RD0945	Ağırlık : 0,384 kg / 0.847 lb Malzeme Türü : Metal Uzunluk : 241 mm / 9.49 inch Aşık Diş Çapı : M12X1,5	2K0505465B, 2K0505465C 2K0505465E
	AU6010 SALINCAK ÜST SOL VE SAĞ RA5155	Ağırlık : 1,298 kg / 2.862 lb Malzeme Türü : Sac Metal	1K0505323H, 1K0505323N
	SE9001 SALINCAK ALT SAĞ RA5150	Ağırlık : 1 kg / 2.205 lb Malzeme Türü : Sac Metal	1K0501530C
	SE9002 SALINCAK ALT SOL RA5151	Ağırlık : 1 kg / 2.205 lb Malzeme Türü : Sac Metal	1K0501529F

* Bu sayfada ve katalogdaki tüm araçların adları, markaları, modelleri, sembolleri, logoları, orjinal numaraları (oe) ve diğer üçüncü parti numaraları sadece referans amaçlı kullanılmaktadır.

TOURAN
1T1, 1T2
2003 - 2010

Resim	Ürün Kodu ve Açıklaması	Detay	OEM
	SK9001 SALINCAK ARKA ALT	Ağırlık : 0,701 kg / 1.545 lb Malzeme Türü : Sac Metal	1K0501529J
	VW6016 SALINCAK ÖN SAĞ RD10227	Ağırlık : 4,543 kg / 10.016 lb Malzeme Türü : Sac Metal	1K0407152P, 1K0407152Q* 1K0407152Q
	VW6016J SALINCAK ÖN ALT SAĞ S737	Ağırlık : 4,015 kg / 8.852 lb Malzeme Türü : Sac Metal	1K0407151P, 1K0407151Q 1K0407152P, 1K0407152Q
	VW6017 SALINCAK ÖN SOL RD10226	Ağırlık : 4,543 kg / 10.016 lb Malzeme Türü : Sac Metal	1K0407151M*, 1K0407151P 1K0407151Q*, 1K0407151Q
	VW6017J SALINCAK ÖN ALT SOL S738	Ağırlık : 4,015 kg / 8.852 lb Malzeme Türü : Sac Metal	1K0407151P, 1K0407151Q 1K0407152P, 1K0407152Q
	VW6018J SALINCAK ÖN SAĞ RB30211	Ağırlık : 4,232 kg / 9.330 lb Malzeme Türü : Döküm Çelik	1K0407152AC, 1K0407152M 1K0407152R
	VW6019J SALINCAK ÖN SOL RB30212	Ağırlık : 4,232 kg / 9.330 lb Malzeme Türü : Döküm Çelik	1K0407151AC, 1K0407151M 1K0407151R
	VW9001 SALINCAK ARKA	Ağırlık : 2,55 kg / 5.622 lb Malzeme Türü : Sac Metal	1K0505311AA, 1K0505311ABÂ 1K0505311H, 1K0505311S 1K0505311T
	AU11014 SALINCAK VE DENGE KOLU BURCU ARKA SOL VE SAĞ	Şasi (Ön / Arka) : ARKA Yön : Sol Ve Sağ Ağırlık : 0.192 kg / 0.423 lb	1K0505543A
	AU11035 SALINCAK VE DENGE KOLU BURCU ARKA SOL VE SAĞ	Şasi (Ön / Arka) : ARKA Yön : Sol Ve Sağ Ağırlık : 0,25 kg / 0.551 lb	1K0505171C
	AU11052 SALINCAK VE DENGE KOLU BURCU SOL VE SAĞ	Yön : Sol Ve Sağ Ağırlık : 0,178 kg / 0.392 lb	1K0505541B, 1K0505541C 1K0505541D











* Bu sayfada ve katalogdaki tüm araçların adları, markaları, modelleri, sembolleri, logoları, orjinal numaraları (oe) ve diğer üçüncü parti numaraları sadece referans amaçlı kullanılmaktadır.

TOURAN
1T1, 1T2
2003 - 2010

Resim	Ürün Kodu ve Açıklaması	Detay	OEM
	AU11088 SALINCAK VE DENGİ KOLU BURCU ARKA	Şasi (Ön / Arka) : ARKA Ağırlık : 0,165 kg / 0.364 lb	1K0505541C, 1K0505541D 3C0505541
	SK11009 SALINCAK VE DENGİ KOLU BURCU ARKA SOL VE SAĞ	Şasi (Ön / Arka) : ARKA Yön : Sol Ve Sağ Ağırlık : 0,176 kg / 0.388 lb	1K0501529J*
	SK11010 SALINCAK VE DENGİ KOLU BURCU ARKA SOL VE SAĞ	Şasi (Ön / Arka) : ARKA Yön : Sol Ve Sağ Ağırlık : 0,196 kg / 0.432 lb Not : BÜYÜK	1K0501529J*
	VW11037 SALINCAK VE DENGİ KOLU BURCU SOL VE SAĞ	Yön : Sol Ve Sağ Ağırlık : 0.11 kg / 0.243 lb	1K0505279A
	VW11042 SALINCAK VE DENGİ KOLU BURCU ORTA SOL VE SAĞ	Yön : Orta Sol Ve Sağ Ağırlık : 0,182 kg / 0.401 lb	1K0407182, 5Q0407182
	VW11043 SALINCAK VE DENGİ KOLU BURCU SAĞ B22141	Yön : Sağ Diğer Taraf : VW11044 Ağırlık : 0,659 kg / 1.453 lb	1K0199232G, 1K0199232H 1K0199232J
	VW11043B SALINCAK VE DENGİ KOLU BURCU SAĞ	Yön : Sağ Diğer Taraf : VW11044B Ağırlık : 0,659 kg / 1.453 lb Not : İÇ BURÇSUZ	1K0199232G, 1K0199232H 1K0199232J
	VW11044 SALINCAK VE DENGİ KOLU BURCU SOL B22142	Yön : Sol Diğer Taraf : VW11043 Ağırlık : 0,678 kg / 1.495 lb	1K0199231G, 1K0199231H 1K0199231J
	VW11044B SALINCAK VE DENGİ KOLU BURCU SOL	Yön : Sol Diğer Taraf : VW11043B Ağırlık : 0,678 kg / 1.495 lb Not : İÇ BURÇSUZ	1K0199231G, 1K0199231H 1K0199231J
	VW11047 SALINCAK VE DENGİ KOLU BURCU İÇ SOL VE SAĞ B37117	Yön : İÇ Sol Ve Sağ Ağırlık : 0,121 kg / 0.267 lb	1K0199231J, 1K0199231J-P 1K0407183E
	VW11051 SALINCAK VE DENGİ KOLU BURCU SOL VE SAĞ	Yön : Sol Ve Sağ Ağırlık : 0.121 kg / 0.267 lb	6Q0407183, 6Q0407183A











* Bu sayfada ve katalogdaki tüm araçların adları, markaları, modelleri, sembolleri, logoları, orijinal numaraları (oe) ve diğer üçüncü parti numaraları sadece referans amaçlı kullanılmaktadır.

TOURAN
1T1, 1T2
2003 - 2010

Resim	Ürün Kodu ve Açıklaması	Detay	OEM
	VW11055 SALINCAK VE DENGE KOLU BURCU İÇ SOL VE SAĞ	Yön : İç Sol Ve Sağ Ağırlık : 0.121 kg / 0.267 lb	1K0407183E, 8J0407183
	VW11056 SALINCAK VE DENGE KOLU BURCU ARKA SOL VE SAĞ	Şasi (Ön / Arka) : ARKA Yön : Sol Ve Sağ Ağırlık : 0.13 kg / 0.287 lb	1K0505203A, 1K0505323D 1K0505323G, 1K0505323H 1K0505323N, 5Q0505323C
	VW11180 Z-ROT BURCU ARKA	Şasi (Ön / Arka) : ARKA Ağırlık : 0.069 kg / 0.152 lb Uzunluk : VW4015 mm / 0.00 inch Aşık Diş Çapı : VW4015K	1K0505465C*, 1K0505465D* 1K0505465H*, 1K0505465J* 1K0505465K*
	VW12131 Z-ROT BURCU ARKA	Şasi (Ön / Arka) : ARKA Ağırlık : 0.084 kg / 0.185 lb	2K0505465B*, 2K0505465C* 2K0505465E*, 2K5505465A*
	VW12131K Z-ROT BURCU ARKA	Şasi (Ön / Arka) : ARKA Ağırlık : 0.168 kg / 0.370 lb	2K0505465B*, 2K0505465C* 2K0505465E*, 2K5505465A*
	VW12159 TAŞIYICI DESTEK BURÇLARI ARKA SOL VE SAĞ	Şasi (Ön / Arka) : ARKA Yön : Sol Ve Sağ Ağırlık : 0,130 kg / 0.287 lb	1K0505553, 1K0505553A
	SK12003 VİRAJ DEMİR LASTİĞİ SOL VE SAĞ RUBBER	Şasi (Ön / Arka) : ÖN Yön : Sol Ve Sağ Ağırlık : 0,075 kg / 0.165 lb Malzeme Türü : Rubber	1K0411303, 1K0411303AL* 1K0411303BK, 1K0411314 3C0411303AA*, 3C0411303T*
	SK12003K VİRAJ DEMİR LASTİĞİ SOL VE SAĞ RUBBER	Şasi (Ön / Arka) : ÖN Yön : Sol Ve Sağ Ağırlık : 0,150 kg / 0.331 lb Malzeme Türü : Rubber	1K0411303, 1K0411303AL* 1K0411303BK, 1K0411314 3C0411303AA*, 3C0411303T*
	VW12017 AMORTİSÖR TAKOZU SOL VE SAĞ AMORTİSÖR TAKOZU	Yön : Sol Ve Sağ Ağırlık : 0.847 kg / 1.867 lb Not : AMORTİSÖR TAKOZU	1K0412331B, 1K0412331C
	VW12109 AMORTİSÖR TAKOZU SOL VE SAĞ AMORTİSÖR RULMANI	Yön : Sol Ve Sağ Ağırlık : 0.26 kg / 0.573 lb Not : AMORTİSÖR RULMANI	6N0412249C, 6N0412249E
	VW12109K AMORTİSÖR TAKOZU SOL VE SAĞ 2 PCS	Yön : Sol Ve Sağ Ağırlık : 0.52 kg / 1.146 lb Not : 2 PCS	6N0412249C, 6N0412249E

* Bu sayfada ve katalogdaki tüm araçların adları, markaları, modelleri, sembolleri, logoları, orijinal numaraları (oe) ve diğer üçüncü parti numaraları sadece referans amaçlı kullanılmaktadır.

TOURAN
1T1, 1T2
2003 - 2010

Resim	Ürün Kodu ve Açıklaması	Detay	OEM
	VW12025 MOTOR TAKOZU ALT SOL VE SAĞ MOTOR TAKOZU ALT	Yön : Alt Sol Ve Sağ Ağırlık : 0.25 kg / 0.551 lb Not : MOTOR TAKOZU ALT	1K0199867A, 1K0199867B 1K0199867Q
	VW12027 MOTOR TAKOZU SOL VE SAĞ MOTOR KULAĞI	Yön : Sol Ve Sağ Ağırlık : 2.02 kg / 4.453 lb Not : MOTOR KULAĞI	1K0199262, 1K0199262CN
	VW12029 MOTOR TAKOZU SOL VE SAĞ MOTOR TAKOZU	Yön : Sol Ve Sağ Ağırlık : 0.585 kg / 1.290 lb Not : Motor takozu	1K0199855AD, 1K0199855BA 1K0199855K
	VW12032 MOTOR TAKOZU SOL VE SAĞ MOTOR TAKOZU	Yön : Sol Ve Sağ Ağırlık : 0.64 kg / 1.411 lb Not : Motor takozu	1K0199855BB, 1K0199855L
	VW12033 MOTOR TAKOZU SOL VE SAĞ MOTOR TAKOZU	Yön : Sol Ve Sağ Ağırlık : 1.84 kg / 4.057 lb Not : Motor takozu	1K0199555AQ, 1K0199555AR 1K0199555Q, 1K0199555R 3C0199555AA, 3C0199555R
	VW12034 MOTOR TAKOZU SOL VE SAĞ MOTOR TAKOZU	Yön : Sol Ve Sağ Ağırlık : 1.9 kg / 4.189 lb Not : Motor takozu	1K0199555BA, 1K0199555BB 1K0199555L, 1K0199555M 1L0199555L
	VW12073 MOTOR TAKOZU SOL VE SAĞ MOTOR TAKOZU	Yön : Sol Ve Sağ Ağırlık : 1.643 kg / 3.622 lb Not : MOTOR TAKOZU	1K0199262AC, 1K0199262AL 1K0199262L
	VW12076 MOTOR TAKOZU SOL VE SAĞ MOTOR TAKOZU	Yön : Sol Ve Sağ Ağırlık : 1.97 kg / 4.343 lb Not : MOTOR TAKOZU	1K0199262AF, 1K0199262AT 1K0199262BB
	VW12077 MOTOR TAKOZU SOL VE SAĞ MOTOR TAKOZU	Yön : Sol Ve Sağ Ağırlık : 1.95 kg / 4.299 lb Not : MOTOR TAKOZU	1K0199262CG, 1K0199262CP
	VW12078 MOTOR TAKOZU SOL VE SAĞ ŞANZUMAN TAKOZU	Yön : Sol Ve Sağ Ağırlık : 1.78 kg / 3.924 lb Not : ŞANZUMAN TAKOZU	1K0199555AC
	VW12082 MOTOR TAKOZU SOL VE SAĞ MOTOR TAKOZU	Yön : Sol Ve Sağ Ağırlık : 2.05 kg / 4.519 lb Not : MOTOR TAKOZU	1K0199262AK, 1K0199262K

* Bu sayfada ve katalogdaki tüm araçların adları, markaları, modelleri, sembolleri, logoları, orjinal numaraları (oe) ve diğer üçüncü parti numaraları sadece referans amaçlı kullanılmaktadır.

TOURAN
1T1, 1T2
2003 - 2010







Resim	Ürün Kodu ve Açıklaması	Detay	OEM
	VW12094 MOTOR TAKOZU SOL VE SAĞ MOTOR TAKOZU	Yön : Sol Ve Sağ Ağırlık : 1.872 kg / 4.127 lb Not : MOTOR TAKOZU	1K0199555N
	VW12097 MOTOR TAKOZU SOL VE SAĞ MOTOR TAKOZU	Yön : Sol Ve Sağ Ağırlık : 0.251 kg / 0.553 lb Not : MOTOR TAKOZU	1K0199868, 1K0199868A 1K0199868C, 1K0199868P 1K0199868Q
	VW12110 MOTOR TAKOZU SOL VE SAĞ MOTOR TAKOZU	Yön : Sol Ve Sağ Ağırlık : 1.918 kg / 4.228 lb Not : MOTOR TAKOZU	1K0199262AB, 1K0199262AM 1K0199262M
	VW12124 MOTOR TAKOZU SOL VE SAĞ	Yön : Sol Ve Sağ Ağırlık : 1.927 kg / 4.248 lb	1K0199262A, 1K0199262AA 1K0199262AS
	VW12106 ŞANZİMAN TAKOZU SOL ŞANZİMAN TAKOZU SOL	Yön : Sol Ağırlık : 1.95 kg / 4.299 lb Not : ŞANZİMAN TAKOZU SOL	1K0199555AT, 1K0199555T
	VW12038 SÜSPANSİYON TAKOZU SOL VE SAĞ SUS. ARA YATAK TAKOZ ARKA	Yön : Sol Ve Sağ Ağırlık : 0.12 kg / 0.265 lb Not : SUS. ARA YATAK TAKOZ ARKA	3C0 511 359, 3C0511359
	VW12051 SÜSPANSİYON TAKOZU SOL VE SAĞ LASTİK DAYANAK SUSPENSİYON	Yön : Sol Ve Sağ Ağırlık : 0.045 kg / 0.099 lb Not : LASTİK DAYANAK SUSPENSİYON	1K0412303B
	VW12086 RADYATÖR TAKOZU SOL VE SAĞ RADYATÖR ÜST LASTİĞİ	Yön : Sol Ve Sağ Ağırlık : 0.024 kg / 0.053 lb Not : RADYATÖR ÜST LASTİĞİ	1K0121367F
	VW13006 DİREKSİYON KÖRÜĞÜ	Ağırlık : 0.145 kg / 0.320 lb	1K0423831A, 5C0423831
	VW13006K DİREKSİYON KÖRÜĞÜ SOL VE SAĞ 2 PİECES	Ağırlık : 0.29 kg / 0.639 lb	1K0423831A, 5C0423831
	VW14003 AKS KÖRÜĞÜ +KELEPÇE+YAĞ. DIŞ	Ağırlık : 0.25 kg / 0.551 lb	1K0 498 203, 1K0498203

* Bu sayfada ve katalogdaki tüm araçların adları, markaları, modelleri, sembolleri, logoları, orjinal numaraları (oe) ve diğer üçüncü parti numaraları sadece referans amaçlı kullanılmaktadır.

TOURAN
1T1, 1T2
2003 - 2010



Resim	Ürün Kodu ve Açıklaması	Detay	OEM
	VW14011 AKS KÖRÜĞÜ +KELEPÇE+YAĞ. İÇ	Ağırlık : 0.236 kg / 0.520 lb	1K0498201D
	AU15001 AMORTİSÖR KÖRÜĞÜ ÖN	Şasi (Ön / Arka) : ÖN Ağırlık : 0,110 kg / 0.243 lb	6N0413175A

TOURAN
1T3
2010 - 2015

Resim	Ürün Kodu ve Açıklaması	Detay	OEM
	VW1014 ROTİL ÖN ALT SAĞ Ø15,6 RB2536	Ağırlık : 0,565 kg / 1.246 lb Konik Ölçüsü : Ø15,6 Bağlantı Delik Çapı : Ø10,5 Aşık Diş Çapı : M12X1,5	1K0407366B, 1K0407366C 1K0407366E, 5Q0407366A
	VW1015 ROTİL ÖN ALT SOL Ø15,6 RB2537	Ağırlık : 0,565 kg / 1.246 lb Konik Ölçüsü : Ø15,6 Bağlantı Delik Çapı : Ø10,5 Aşık Diş Çapı : M12X1,5	1K0407365B, 1K0407365C 1K0407365E, 5Q0407365A
	VW2008 ROTBAŞI ÖN SAĞ RD0342	Ağırlık : 0,412 kg / 0.908 lb Uzunluk : 95 mm / 3.74 inch Gövde Diş Çapı : M16X1,5 Aşık Diş Çapı : M12X1,5 Aşık Konik Çapı : Ø12,7	1K0423812A, 1K0423812C 1K0423812E, 1K0423812G 1K0423812J, 1K0423812K 1KD423812A
	VW2009 ROTBAŞI ÖN SOL RD0343	Ağırlık : 0,412 kg / 0.908 lb Uzunluk : 95 mm / 3.74 inch Gövde Diş Çapı : M16X1,5 Aşık Diş Çapı : M12X1,5 Aşık Konik Çapı : Ø13,5	1K0423811A, 1K0423811C 1K0423811E, 1K0423811G 1K0423811J, 1K0423811K 1KD423811A
	VW3009 ROTMİLİ SAĞ-SOL 310 RB2838	Ağırlık : 0,665 kg / 1.466 lb Uzunluk : 311 mm / 12.24 inch Gövde Diş Çapı : M16X1,5 Aşık Diş Çapı : M16X1,5	1K0423810A
	VW20083009 ROT TAKIMI ÖN AKS SAĞ RB288137	Ağırlık : 1,078 kg / 2.377 lb Rotbaşı : VW2008 Rotmili : VW3009	
	VW20093009 ROT TAKIMI ÖN SOL RB288138	Ağırlık : 1,077 kg / 2.374 lb Rotbaşı : VW2009 Rotmili : VW3009	
	SK4005 Z ROT ÖM SAĞ-SOL L=335MM	Ağırlık : 0,322 kg / 0.710 lb Malzeme Türü : Metal Uzunluk : 335 mm / 13.19 inch Aşık Diş Çapı : M12X1,5	5Q0411315B











* Bu sayfada ve katalogdaki tüm araçların adları, markaları, modelleri, sembolleri, logoları, orjinal numaraları (oe) ve diğer üçüncü parti numaraları sadece referans amaçlı kullanılmaktadır.

TOURAN
1T3
2010 - 2015

Resim	Ürün Kodu ve Açıklaması	Detay	OEM
	VW4014 Z ROT ÖN SAĞ-SOL METAL 335 RB2935	Ağırlık : 0,46 kg / 1.014 lb Malzeme Türü : Metal Uzunluk : 335 mm / 13.19 inch Aşık Diş Çapı : M12X1,5	1K0411315B, 1K0411315D 1K0411315J, 1K0411315K 1K0411315R, 5Q0411315A 5Q0411315B
	AU9006 SALINCAK ÖN TARAF SAĞ	Ağırlık : 1,79 kg / 3.946 lb Malzeme Türü : Sac Metal	1T0505224F
	AU9007 SALINCAK ÖN TARAF SOL	Ağırlık : 1,79 kg / 3.946 lb Malzeme Türü : Sac Metal	1T0505223F
	VW6018 SALINCAK ÖN SAĞ RB30219	Ağırlık : 4,85 kg / 10.692 lb Malzeme Türü : Döküm Çelik	1K0407152AC*, 1K0407152M* 1K0407152P, 1K0407152Q 1K0407152R*
	VW6018J SALINCAK ÖN SAĞ RB30211	Ağırlık : 4,232 kg / 9.330 lb Malzeme Türü : Döküm Çelik	1K0407152AC, 1K0407152M 1K0407152R
	VW6019 SALINCAK ÖN SOL RB30218	Ağırlık : 4,85 kg / 10.692 lb Malzeme Türü : Döküm Çelik	1K0407151AC*, 1K0407151AC 1K0407151M*, 1K0407151M 1K0407151R*, 1K0407151R
	VW6019J SALINCAK ÖN SOL RB30212	Ağırlık : 4,232 kg / 9.330 lb Malzeme Türü : Döküm Çelik	1K0407151AC, 1K0407151M 1K0407151R
	VW9001 SALINCAK ARKA	Ağırlık : 2,55 kg / 5.622 lb Malzeme Türü : Sac Metal	1K0505311AA, 1K0505311ABÂ 1K0505311H, 1K0505311S 1K0505311T
	VW9004 SALINCAK ARKA	Ağırlık : 1,3 kg / 2.866 lb Malzeme Türü : Sac Metal	5Q0505323C, 5Q0505323D
	AU11035 SALINCAK VE DENGE KOLU BURCU ARKA SOL VE SAĞ	Şasi (Ön / Arka) : ARKA Yön : Sol Ve Sağ Ağırlık : 0,25 kg / 0.551 lb	1K0505171C
	AU11088 SALINCAK VE DENGE KOLU BURCU ARKA	Şasi (Ön / Arka) : ARKA Ağırlık : 0,165 kg / 0.364 lb	1K0505541C, 1K0505541D 3C0505541







* Bu sayfada ve katalogdaki tüm araçların adları, markaları, modelleri, sembolleri, logoları, orjinal numaraları (oe) ve diğer üçüncü parti numaraları sadece referans amaçlı kullanılmaktadır.

TOURAN
1T3
2010 - 2015



Resim	Ürün Kodu ve Açıklaması	Detay	OEM
	VW11037 SALINCAK VE DENGE KOLU BURCU SOL VE SAĞ	Yön : Sol Ve Sağ Ağırlık : 0.11 kg / 0.243 lb	1K0505279A
	VW11042 SALINCAK VE DENGE KOLU BURCU ORTA SOL VE SAĞ	Yön : Orta Sol Ve Sağ Ağırlık : 0,182 kg / 0.401 lb	1K0407182, 5Q0407182
	VW11051 SALINCAK VE DENGE KOLU BURCU SOL VE SAĞ	Yön : Sol Ve Sağ Ağırlık : 0.121 kg / 0.267 lb	6Q0407183, 6Q0407183A
	VW11056 SALINCAK VE DENGE KOLU BURCU ARKA SOL VE SAĞ	Şasi (Ön / Arka) : ARKA Yön : Sol Ve Sağ Ağırlık : 0.13 kg / 0.287 lb	1K0505203A, 1K0505323D 1K0505323G, 1K0505323H 1K0505323N, 5Q0505323C
	VW12159 TAŞIYICI DESTEK BURÇLARI ARKA SOL VE SAĞ	Şasi (Ön / Arka) : ARKA Yön : Sol Ve Sağ Ağırlık : 0,130 kg / 0.287 lb	1K0505553, 1K0505553A
	SK12003 VİRAJ DEMİR LASTİĞİ SOL VE SAĞ RUBBER	Şasi (Ön / Arka) : ÖN Yön : Sol Ve Sağ Ağırlık : 0,075 kg / 0.165 lb Malzeme Türü : Rubber	1K0411303, 1K0411303AL* 1K0411303BK, 1K0411314 3C0411303AA*, 3C0411303T*
	SK12003K VİRAJ DEMİR LASTİĞİ SOL VE SAĞ RUBBER	Şasi (Ön / Arka) : ÖN Yön : Sol Ve Sağ Ağırlık : 0,150 kg / 0.331 lb Malzeme Türü : Rubber	1K0411303, 1K0411303AL* 1K0411303BK, 1K0411314 3C0411303AA*, 3C0411303T*
	VW12017 AMORTİSÖR TAKOZU SOL VE SAĞ AMORTİSÖR TAKOZU	Yön : Sol Ve Sağ Ağırlık : 0.847 kg / 1.867 lb Not : AMORTİSÖR TAKOZU	1K0412331B, 1K0412331C
	VW12109 AMORTİSÖR TAKOZU SOL VE SAĞ AMORTİSÖR RULMANI	Yön : Sol Ve Sağ Ağırlık : 0.26 kg / 0.573 lb Not : AMORTİSÖR RULMANI	6N0412249C, 6N0412249E
	VW12109K AMORTİSÖR TAKOZU SOL VE SAĞ 2 PCS	Yön : Sol Ve Sağ Ağırlık : 0.52 kg / 1.146 lb Not : 2 PCS	6N0412249C, 6N0412249E
	VW12027 MOTOR TAKOZU SOL VE SAĞ MOTOR KULAĞI	Yön : Sol Ve Sağ Ağırlık : 2.02 kg / 4.453 lb Not : MOTOR KULAĞI	1K0199262, 1K0199262CN

* Bu sayfada ve katalogdaki tüm araçların adları, markaları, modelleri, sembolleri, logoları, orjinal numaraları (oe) ve diğer üçüncü parti numaraları sadece referans amaçlı kullanılmaktadır.

TOURAN
1T3
2010 - 2015











Resim	Ürün Kodu ve Açıklaması	Detay	OEM
	VW12029 MOTOR TAKOZU SOL VE SAĞ MOTOR TAKOZU	Yön : Sol Ve Sağ Ağırlık : 0.585 kg / 1.290 lb Not : Motor takozu	1K0199855AD, 1K0199855BA 1K0199855K
	VW12051 SÜSPANSİYON TAKOZU SOL VE SAĞ LASTİK DAYANAK SUSPENSİYON	Yön : Sol Ve Sağ Ağırlık : 0.045 kg / 0.099 lb Not : LASTİK DAYANAK SUSPENSİYON	1K0412303B
	VW12086 RADYATÖR TAKOZU SOL VE SAĞ RADYATÖR ÜST LASTİĞİ	Yön : Sol Ve Sağ Ağırlık : 0.024 kg / 0.053 lb Not : RADYATÖR ÜST LASTİĞİ	1K0121367F
	VW13006 DİREKSİYON KÖRÜĞÜ	Ağırlık : 0.145 kg / 0.320 lb	1K0423831A, 5C0423831
	VW13006K DİREKSİYON KÖRÜĞÜ SOL VE SAĞ 2 PİECES	Ağırlık : 0.29 kg / 0.639 lb	1K0423831A, 5C0423831
	VW14003 AKS KÖRÜĞÜ +KELEPÇE+YAĞ. DIŞ	Ağırlık : 0.25 kg / 0.551 lb	1K0 498 203, 1K0498203
	AU15001 AMORTİSÖR KÖRÜĞÜ ÖN	Şasi (Ön / Arka) : ÖN Ağırlık : 0,110 kg / 0.243 lb	6N0413175A

TOURAN
5T1
2015 -

Resim	Ürün Kodu ve Açıklaması	Detay	OEM
	VW1019 ROTİL ÖN SAĞ Ø15,3 RB2538	Ağırlık : 0,555 kg / 1.224 lb Konik Ölçüsü : Ø15,3 Bağlantı Delik Çapı : Ø10,5 Aşık Diş Çapı : M12X1,5	3C0407366A
	VW1020 ROTİL ÖN SOL Ø15,3 RB2539	Ağırlık : 0,555 kg / 1.224 lb Konik Ölçüsü : Ø15,3 Bağlantı Delik Çapı : Ø10,5 Aşık Diş Çapı : M12X1,5	3C0407365A
	SK4005 Z ROT ÖM SAĞ-SOL L=335MM	Ağırlık : 0,322 kg / 0.710 lb Malzeme Türü : Metal Uzunluk : 335 mm / 13.19 inch Aşık Diş Çapı : M12X1,5	5Q0411315B

* Bu sayfada ve katalogdaki tüm araçların adları, markaları, modelleri, sembolleri, logoları, orjinal numaraları (oe) ve diğer üçüncü parti numaraları sadece referans amaçlı kullanılmaktadır.

TOURAN
5T1
2015 -







Resim	Ürün Kodu ve Açıklaması	Detay	OEM
	AU9012 SALINCAK ARKA ALT SAĞ	Ağırlık : 1,640 kg / 3.616 lb Malzeme Türü : Sac Metal	5Q0505224D
	AU9013 SALINCAK ARKA ALT SOL	Ağırlık : 1,640 kg / 3.616 lb Malzeme Türü : Sac Metal	5Q0505223D
	VW6055 SALINCAK ÖN ALT SAĞ	Ağırlık : 3,768 kg / 8.307 lb Malzeme Türü : Sac Metal	3Q0407152E*, 3Q0407152E 3Q0407152F*, 3Q0407152F 3Q0407154B*, 3Q0407154B
	VW6055J SALINCAK ÖN ALT SAĞ	Malzeme Türü : Sac Metal	3Q0407152E, 3Q0407152F 3Q0407154B
	VW6056 SALINCAK ÖN ALT SOL	Ağırlık : 3,768 kg / 8.307 lb Malzeme Türü : Sac Metal	3Q0407151E*, 3Q0407151E 3Q0407151F*, 3Q0407151F 3Q0407153B*, 3Q0407153B
	VW6056J SALINCAK ÖN ALT SOL	Malzeme Türü : Sac Metal	3Q0407151E, 3Q0407151F 3Q0407153B
	VW9005 SALINCAK ARKA ALT ÖNDEN	Ağırlık : 0,566 kg / 1.248 lb Malzeme Türü : Sac Metal	5Q0501529C, 5Q0501529D 5Q0501529E, 5Q0501529F
	AU11068 SALINCAK VE DENGE KOLU BURCU ARKA ALT SOL VE SAĞ METAL	Şasi (Ön / Arka) : ARKA Yön : Alt Sol Ve Sağ Ağırlık : 0,201 kg / 0.443 lb Malzeme Türü : Metal	PART OF 5Q0505223D, PART OF 5Q0505224D
	VW11042 SALINCAK VE DENGE KOLU BURCU ORTA SOL VE SAĞ	Yön : Orta Sol Ve Sağ Ağırlık : 0,182 kg / 0.401 lb	1K0407182, 5Q0407182
	VW11063 SALINCAK VE DENGE KOLU BURCU SOL VE SAĞ	Yön : Sol Ve Sağ Ağırlık : 0.34 kg / 0.750 lb	5Q0407183D, 5Q0407183E
	VW11075 SALINCAK VE DENGE KOLU BURCU ARKA SOL VE SAĞ	Şasi (Ön / Arka) : ARKA Yön : Sol Ve Sağ Ağırlık : 0,870 kg / 1.918 lb Not : FORWARD and INNER	Part of 5Q0501529C, Part of 5Q0501529D Part of 5Q0501529E, Part of 5Q0501529F

* Bu sayfada ve katalogdaki tüm araçların adları, markaları, modelleri, sembolleri, logoları, orjinal numaraları (oe) ve diğer üçüncü parti numaraları sadece referans amaçlı kullanılmaktadır.

TOURAN
5T1
2015 -

Resim	Ürün Kodu ve Açıklaması	Detay	OEM
	VW11076 SALINCAK VE DENGELER BURCU ARKA SOL VE SAĞ	Şasi (Ön / Arka) : ARKA Yön : Sol Ve Sağ Ağırlık : 0,870 kg / 1.918 lb Not : FORWARD and OUTER	Part of 5Q0501529C, Part of 5Q0501529D Part of 5Q0501529E, Part of 5Q0501529F
	AU11080 BEŞİK (TRAVERS) BURCU ÖN ALT	Şasi (Ön / Arka) : ÖN Yön : Alt Ağırlık : 0,135 kg / 0.298 lb	5Q0505553
	AU12022 MOTOR TAKOZU SOL VE SAĞ	Yön : Sol Ve Sağ Ağırlık : 1.58 kg / 3.483 lb Malzeme Türü : Motor Takozu	5Q0199262, 5Q0199262BH 5Q0199262DE
	AU12023 MOTOR TAKOZU SOL VE SAĞ	Yön : Sol Ve Sağ Ağırlık : 1.58 kg / 3.483 lb Malzeme Türü : Motor Takozu Not : 7 İLERİ	5Q0199262BE, 5Q0199262BF
	AU12026 MOTOR TAKOZU ÖN SOL VE SAĞ	Şasi (Ön / Arka) : ÖN Yön : Sol Ve Sağ Ağırlık : 0,850 kg / 1.874 lb	5Q0199855AD, 5Q0199855J 5Q0199855P, 5Q0199855Q
	SK12005 MOTOR TAKOZU ÖN SAĞ	Şasi (Ön / Arka) : ÖN Yön : Sağ Ağırlık : 1,575 kg / 3.472 lb	5Q0199262CK
	VW12051 SÜSPANSİYON TAKOZU SOL VE SAĞ	Yön : Sol Ve Sağ Ağırlık : 0.045 kg / 0.099 lb Not : LASTİK DAYANAK SUSPENSİYON	1K0412303B
	VW12086 RADYATÖR TAKOZU SOL VE SAĞ	Yön : Sol Ve Sağ Ağırlık : 0.024 kg / 0.053 lb Not : RADYATÖR ÜST LASTİĞİ	1K0121367F
	VW13006 DİREKSİYON KÖRÜĞÜ	Ağırlık : 0.145 kg / 0.320 lb	1K0423831A, 5C0423831
	VW13006K DİREKSİYON KÖRÜĞÜ SOL VE SAĞ 2 PİECES	Ağırlık : 0.29 kg / 0.639 lb	1K0423831A, 5C0423831

TRANSPORTER
II-III T3
1979 - 1992

Resim	Ürün Kodu ve Açıklaması	Detay	OEM
	VW1016 ROTİL ÜST SOL VE SAĞ Ø20 RD0415	Ağırlık : 0,68 kg / 1.499 lb Konik Ölçüsü : Ø20 Aşık Diş Çapı : M18X1,5 Rotil Gövde Çapı : Ø48,4	211405371A, 211405371B
	VW1017 ROTİL ÜST SAĞ-SOL RD0516	Ağırlık : 0,545 kg / 1.202 lb Konik Ölçüsü : Ø18,2 Bağlantı Delik Çapı : M10X1,5 Aşık Diş Çapı : M16X1,5	251407361
	VW1018 ROTİL ALT SAĞ-SOL RD0416	Ağırlık : 0,675 kg / 1.488 lb Konik Ölçüsü : Ø20 Aşık Diş Çapı : M18X1,5 Rotil Gövde Çapı : Ø48,4	251407187, 251407187A 251407187B
	VW2003 ROTBAŞI SAĞ-SOL RD0339	Ağırlık : 0,3 kg / 0.661 lb Uzunluk : 79 mm / 3.11 inch Gövde Diş Çapı : M14X1,5 Aşık Diş Çapı : M12X1,5 Aşık Konik Çapı : Ø12,3	171419811, 171419811A 171419812, 251419811 32111116463, 477419811 477419815, 94434733300
	VW3010 ROTMİLİ SAĞ-SOL 382 RD0813	Ağırlık : 0,685 kg / 1.510 lb Uzunluk : 384 mm / 15.12 inch Gövde Diş Çapı : M14X1,5 Aşık Diş Çapı : M14X1,5	251419803, 251419821
	VW20033010 ROT TAKIMI ÖN AKS RD088114	Ağırlık : 0,987 kg / 2.176 lb Rotbaşı : VW2003 Rotmilî : VW3010	171419804, 251419803 251419803a
	VW11006 SALINCAK VE DENGE KOLU BURCU ORTA SOL VE SAĞ	Yön : Orta Sol Ve Sağ Ağırlık : 0,18 kg / 0.397 lb	251407183, 251407183B R251407183B
	VW11007 SALINCAK VE DENGE KOLU BURCU ÖN ÜST SOL VE SAĞ	Şasi (Ön / Arka) : ÖN Yön : Üst Sol Ve Sağ Ağırlık : 0,229 kg / 0.505 lb	251407077, 251407077B
	VW11009 SALINCAK VE DENGE KOLU BURCU ORTA SOL VE SAĞ	Yön : Orta Sol Ve Sağ Ağırlık : 0,131 kg / 0.289 lb	701407087
	VW11074 SALINCAK VE DENGE KOLU BURCU ARKA SOL VE SAĞ	Şasi (Ön / Arka) : ARKA Yön : Sol Ve Sağ Ağırlık : 0.19 kg / 0.419 lb	251501131A
	VW12118 TAŞIYICI DESTEK BURÇLARI ÖN ALT SOL VE SAĞ	Şasi (Ön / Arka) : ÖN Yön : Alt Sol Ve Sağ Ağırlık : 0.1 kg / 0.220 lb	251407179

* Bu sayfada ve katalogdaki tüm araçların adları, markaları, modelleri, sembolleri, logoları, orjinal numaraları (oe) ve diğer üçüncü parti numaraları sadece referans amaçlı kullanılmaktadır.

TRANSPORTER
II-III T3
1979 - 1992











Resim	Ürün Kodu ve Açıklaması	Detay	OEM
	VW12136 EGZOZ TAKOZU	Ağırlık : 0,185 kg / 0.408 lb	068251393A, 068251393B 33251393, 68251393A 68251393B
	VW13005 DİREKSİYON KÖRÜĞÜ	Ağırlık : 0.11 kg / 0.243 lb	251419831A

TRANSPORTER
IV T4
1990 - 2003

Resim	Ürün Kodu ve Açıklaması	Detay	OEM
	VW1021 ROTİL ÜST SAĞ-SOL RD0418	Ağırlık : 0,545 kg / 1.202 lb Konik Ölçüsü : Ø17,9 Aşık Diş Çapı : M16X1,5 Rotil Gövde Çapı : Ø45,5	701407187, 701407187A 701407187B
	VW1022 ROTİL ALT SAĞ-SOL RD0517	Ağırlık : 0,676 kg / 1.490 lb Konik Ölçüsü : Ø20,3 Aşık Diş Çapı : M16X1,5	701407361, 701407361B
	VW1023 ROTİL ALT SAĞ-SOL RD0521	Ağırlık : 0,615 kg / 1.356 lb Konik Ölçüsü : Ø20,4 Aşık Diş Çapı : M16X1,5	700407361, 701407361C 7D0407361, 7D0407361C
	VW2010 ROTBAŞI SAĞ RD0313	Ağırlık : 0,39 kg / 0.860 lb Uzunluk : 87 mm / 3.43 inch Gövde Diş Çapı : M16X1,5 Aşık Diş Çapı : M12X1,5 Aşık Konik Çapı : Ø12,8	701419812
	VW2011 ROTBAŞI SOL RD0314	Ağırlık : 0,391 kg / 0.862 lb Uzunluk : 92 mm / 3.62 inch Gövde Diş Çapı : M16X1,5 Aşık Diş Çapı : M12X1,5 Aşık Konik Çapı : Ø14,8	701419811A
	VW2012 ROTBAŞI SAĞ RD0315	Ağırlık : 0,454 kg / 1.001 lb Uzunluk : 92 mm / 3.62 inch Gövde Diş Çapı : M16X1,5 Aşık Diş Çapı : M12X1,5 Aşık Konik Çapı : Ø14,8	701419812A
	VW2013 ROTBAŞI SOL RD0316	Ağırlık : 0,408 kg / 0.899 lb Uzunluk : 92 mm / 3.62 inch Gövde Diş Çapı : M16X1,5 Aşık Diş Çapı : M12X1,5 Aşık Konik Çapı : Ø14,8	701419811B
	VW2014 ROTBAŞI SAĞ	Ağırlık : 0,464 kg / 1.023 lb Uzunluk : 85,5 mm / 3.37 inch Gövde Diş Çapı : M16X1,5 Aşık Diş Çapı : M12X1,5 Aşık Konik Çapı : Ø14,8	701419812B, 701419812C 701419812D











* Bu sayfada ve katalogdaki tüm araçların adları, markaları, modelleri, sembolleri, logoları, orijinal numaraları (oe) ve diğer üçüncü parti numaraları sadece referans amaçlı kullanılmaktadır.

TRANSPORTER
IV T4
1990 - 2003

Resim	Ürün Kodu ve Açıklaması	Detay	OEM
	VW2015 ROTBAŞI SOL	Ağırlık : 0,415 kg / 0.915 lb Uzunluk : 85,5 mm / 3.37 inch Gövde Diş Çapı : M16X1,5 Aşık Diş Çapı : M12X1,5 Aşık Konik Çapı : Ø14,8	701419811C, 701419811E
	VW3011 ROTMİLİ SAĞ-SOL LASTİKSİZ 295 RD0836	Ağırlık : 0,65 kg / 1.433 lb Uzunluk : 294 mm / 11.57 inch Gövde Diş Çapı : M14X1,5 Aşık Diş Çapı : M16X1,5	701419803, 701419810 701419821A, 702419821A
	VW3012 ROTMİLİ SAĞ-SOL 295 RD0835	Ağırlık : 0,647 kg / 1.426 lb Uzunluk : 294 mm / 11.57 inch Gövde Diş Çapı : M14X1,5 Aşık Diş Çapı : M16X1,5	701419803C, 701419803CY 701419804F, 701419810A 701419810B, 701419821 701419821C, 702419803D 702419821A, 702419821B
	VW20103011 ROT TAKIMI ÖN AKS SAĞ RD088173	Ağırlık : 1,047 kg / 2.308 lb Rotbaşı : VW2010 Rotmilî : VW3011	7022419804A, 702419804A
	VW20103012 ROT TAKIMI ÖN AKS SAĞ RD088134	Ağırlık : 1,044 kg / 2.302 lb Rotbaşı : VW2010 Rotmilî : VW3012	701419804A, 701419804C
	VW20113011 ROT TAKIMI ÖN AKS SOL RD088133	Ağırlık : 1,047 kg / 2.308 lb Rotbaşı : VW2011 Rotmilî : VW3011	701419803A, 701419803C 702419803A
	VW20113012 ROT TAKIMI ÖN AKS SOL RD088174	Ağırlık : 1,038 kg / 2.288 lb Rotbaşı : VW2011 Rotmilî : VW3012	701419803A, 702419803A
	VW20123011 ROT TAKIMI ÖN AKS SAĞ RD088138	Ağırlık : 1.157 kg / 2.551 lb Rotbaşı : VW2012 Rotmilî : VW3011	701419804D
	VW20123012 ROT TAKIMI ÖN AKS SAĞ RD088176	Ağırlık : 1,054 kg / 2.324 lb Rotbaşı : VW2012 Rotmilî : VW3012	701419804B, 702419804C
	VW20133011 ROT TAKIMI ÖN AKS SOL RD088137	Ağırlık : 1.157 kg / 2.551 lb Rotbaşı : VW2013 Rotmilî : VW3011	701419803D
	VW20133012 ROT TAKIMI ÖN AKS SOL RD088175	Ağırlık : 1,053 kg / 2.321 lb Rotbaşı : VW2013 Rotmilî : VW3012	701419803B, 702419803C

* Bu sayfada ve katalogdaki tüm araçların adları, markaları, modelleri, sembolleri, logoları, orijinal numaraları (oe) ve diğer üçüncü parti numaraları sadece referans amaçlı kullanılmaktadır.

TRANSPORTER
IV T4
1990 - 2003

Resim	Ürün Kodu ve Açıklaması	Detay	OEM
	VW20143011 ROT TAKIMI ÖN AKS SAĞ RD088171	Ağırlık : 1,157 kg / 2.551 lb Rotbaşı : VW2014 Rotmili : VW3011	701419804E
	VW20143012 ROT TAKIMI ÖN AKS SAĞ RD088178	Ağırlık : 1,157 kg / 2.551 lb Rotbaşı : VW2014 Rotmili : VW3012	701419804C, 702419804C
	VW20153011 ROT TAKIMI ÖN AKS SOL RD088172	Ağırlık : 1,064 kg / 2.346 lb Rotbaşı : VW2015 Rotmili : VW3011	701419803E, 701419804E
	VW20153012 ROT TAKIMI ÖN AKS SOL RD088177	Ağırlık : 1,063 kg / 2.344 lb Rotbaşı : VW2015 Rotmili : VW3012	701419803C, 702419803C
	VW4017 Z ROT SOL VE SAĞ METAL RD0920	Ağırlık : 0,31 kg / 0.683 lb Malzeme Türü : Metal Uzunluk : 109 mm / 4.29 inch	701411049, 7D0411049
	VW4018 Z ROT ÖN SAĞ-SOL METAL 108 RD0928	Ağırlık : 0,416 kg / 0.917 lb Malzeme Türü : Metal Uzunluk : 108 mm / 4.25 inch Aşık Diş Çapı : M12X1,5	701411049B
	VW6010 SALINCAK ÖN ALT SAĞ	Ağırlık : 7.609 kg / 16.775 lb Malzeme Türü : Döküm Çelik	7D0407152A
	VW6011 SALINCAK ÖN ALT SOL	Ağırlık : 7.609 kg / 16.775 lb Malzeme Türü : Döküm Çelik	7D0407151A
	VW6030 SALINCAK ÖN ALT SOL	Ağırlık : 6,674 kg / 14.714 lb Malzeme Türü : Döküm Çelik	701407151A, 701407151C 701407152A
	VW6031 SALINCAK ÖN ALT SAĞ	Ağırlık : 6,674 kg / 14.714 lb Malzeme Türü : Döküm Çelik	701407151A, 701407152A 701407152C
	VW11019 SALINCAK VE DENGE KOLU BURCU SOL VE SAĞ B405829	Yön : Sol Ve Sağ Ağırlık : 0,135 kg / 0.298 lb	701407140, 701407140C 7D0407140











* Bu sayfada ve katalogdaki tüm araçların adları, markaları, modelleri, sembolleri, logoları, orjinal numaraları (oe) ve diğer üçüncü parti numaraları sadece referans amaçlı kullanılmaktadır.

TRANSPORTER
IV T4
1990 - 2003

Resim	Ürün Kodu ve Açıklaması	Detay	OEM
	VW11019Y SALINCAK VE DENGE KOLU BURCU SOL VE SAĞ	Yön : Sol Ve Sağ Ağırlık : 0.135 kg / 0.298 lb Not : YARIKLI	701407140, 701407140B 701407140C, 7D0407140 7D0407140A
	VW11025 SALINCAK VE DENGE KOLU BURCU ORTA SOL VE SAĞ B405834	Yön : Orta Sol Ve Sağ Ağırlık : 0,192 kg / 0.423 lb	701407183C, 7D0407183
	VW11031 SALINCAK VE DENGE KOLU BURCU ORTA SOL VE SAĞ	Yön : Orta Sol Ve Sağ Ağırlık : 0,141 kg / 0.311 lb	701407077, 701407077A
	VW11040 SALINCAK VE DENGE KOLU BURCU SOL VE SAĞ	Yön : Sol Ve Sağ Ağırlık : 0,191 kg / 0.421 lb	701501131
	VW11074 SALINCAK VE DENGE KOLU BURCU ARKA SOL VE SAĞ	Şasi (Ön / Arka) : ARKA Yön : Sol Ve Sağ Ağırlık : 0.19 kg / 0.419 lb	251501131A
	AU11023 Z-ROT BURCU ARKA	Şasi (Ön / Arka) : ARKA Ağırlık : 0.26 kg / 0.573 lb Uzunluk : AU4021 mm / 0.00 inch Aşık Diş Çapı : VW4017	1J0505466B*
	VW12113 Z-ROT BURCU ÖN SOL VE SAĞ RUBBER	Şasi (Ön / Arka) : ÖN Yön : Sol Ve Sağ Ağırlık : 0.023 kg / 0.051 lb Malzeme Türü : Rubber	7D0411045
	VW12113K Z-ROT BURCU ÖN SOL VE SAĞ RUBBER	Şasi (Ön / Arka) : ÖN Yön : Sol Ve Sağ Ağırlık : 0.046 kg / 0.101 lb Malzeme Türü : Rubber	7D0411045*
	VW12132 Z-ROT BURCU ÖN	Şasi (Ön / Arka) : ÖN	701411049B*
	VW12132K Z-ROT BURCU ÖN	Şasi (Ön / Arka) : ÖN	701411049B*
	VW12133 ROTMİLİ BURCU VE LASTİĞİ ÖN	Şasi (Ön / Arka) : ÖN	701419804C*, 701419804D* 701419804E*, 701419804F* 701419810A*, 701419810B* 702419803A*, 702419803B* 702419803C*, 702419803D*





* Bu sayfada ve katalogdaki tüm araçların adları, markaları, modelleri, sembolleri, logoları, orijinal numaraları (oe) ve diğer üçüncü parti numaraları sadece referans amaçlı kullanılmaktadır.

TRANSPORTER
IV T4
1990 - 2003

Resim	Ürün Kodu ve Açıklaması	Detay	OEM
	VW12133K ROTMİLİ BURCU VE LASTİĞİ ÖN	Şasi (Ön / Arka) : ÖN	701419804C*, 701419804D* 701419804E*, 701419804F* 701419810A*, 701419810B* 702419803A*, 702419803B* 702419803C*, 702419803D*
	VW12059 VİRAJ DEMİR LASTİĞİ SOL VE SAĞ RUBBER	Şasi (Ön / Arka) : ÖN Yön : Sol Ve Sağ Ağırlık : 0,025 kg / 0.055 lb Malzeme Türü : Rubber	701411041
	VW12059K VİRAJ DEMİR LASTİĞİ SOL VE SAĞ RUBBER	Şasi (Ön / Arka) : ÖN Yön : Sol Ve Sağ Ağırlık : 0.05 kg / 0.110 lb Malzeme Türü : Rubber	701407077*, 701407077A*
	VW12035 MOTOR TAKOZU SOL VE SAĞ MOTOR TAKOZU YAĞLI	Yön : Sol Ve Sağ Ağırlık : 1.704 kg / 3.757 lb Not : MOTOR TAKOZU YAĞLI	701199132C, 7D0199132C 7D0199132D, 7D0199132E
	VW12114 MOTOR TAKOZU SOL VE SAĞ ŞANZUMAN BURCU	Yön : Sol Ve Sağ Ağırlık : 0.47 kg / 1.036 lb Not : ŞANZUMAN BURCU	701399207B part of, 701399207B*
	VW12122Â MOTOR TAKOZU VW12122		701199201C, 701199201G
	VW12119 ŞANZIMAN TAKOZU SOL VE SAĞ	Şasi (Ön / Arka) : ÖN Yön : Sol Ve Sağ Ağırlık : 0,220 kg / 0.485 lb	701399661
	VW12135 EGZOZ TAKOZU	Ağırlık : 0,155 kg / 0.342 lb	1H0253144, 1H0253144A 1H0253144C, 1H0253409C 6N0253144
	VW13003 DİREKSİYON KÖRÜĞÜ	Ağırlık : 0.115 kg / 0.254 lb	7D0419831
	VW14005 AKS KÖRÜĞÜ +KELEPÇE+YAĞ. İÇ	Ağırlık : 0.21 kg / 0.463 lb	701498201
	VW14010 AKS KÖRÜĞÜ +KELEPÇE+YAĞ. DIŞ		

* Bu sayfada ve katalogdaki tüm araçların adları, markaları, modelleri, sembolleri, logoları, orjinal numaraları (oe) ve diğer üçüncü parti numaraları sadece referans amaçlı kullanılmaktadır.

TRANSPORTER
V T5
2003 - 2011

Resim	Ürün Kodu ve Açıklaması	Detay	OEM
	VW1024 ROTİL ALT SAĞ-SOL RD0534	Ağırlık : 0,611 kg / 1.347 lb Konik Ölçüsü : Ø18,3 Aşık Diş Çapı : M14X1,5	7E0407361, 7H0407361 7H0407361A
	VW1030 ROTİL ALT	Ağırlık : 0,552 kg / 1.217 lb Konik Ölçüsü : Ø18,3 Bağlantı Delik Çapı : Ø13 Aşık Diş Çapı : M14X1,5	7H8407361, 7H8407361A
	VW1030K ROTİL ÖN ALT Ø18,3	Ağırlık : 0,600 kg / 1.323 lb Konik Ölçüsü : Ø18,3 Bağlantı Delik Çapı : Ø13 Aşık Diş Çapı : M14X1,5	7H8407361, 7H8407361A
	VW2016 ROTBAŞI SAĞ RD0345	Ağırlık : 1,071 kg / 2.361 lb Uzunluk : 235 mm / 9.25 inch Gövde Diş Çapı : M16X1,5 Aşık Diş Çapı : M14X1,5 Aşık Konik Çapı : Ø16,6	1H0422818E, 7H0422818B 7H0422818C
	VW2017 ROTBAŞI SOL RD0344	Ağırlık : 1,062 kg / 2.341 lb Uzunluk : 235 mm / 9.25 inch Gövde Diş Çapı : M16X1,5 Aşık Diş Çapı : M14X1,5 Aşık Konik Çapı : Ø16,6	7H0422817, 7H0422817A 7H0422817B, 7H0422817C
	VW3013 ROTMİLİ SAĞ- SOL M16X1,5 RHT , L= 190 MM	Ağırlık : 0,57 kg / 1.257 lb Uzunluk : 177 mm / 6.97 inch Gövde Diş Çapı : M16X1,5 Aşık Diş Çapı : M16X1,5	7H0419 821D, 7H0419803C* 7H0419803D, 7H0419804C* 7H0422 817C
	VW20163013 ROT TAKIMI ÖN AKS SAĞ RD088221	Ağırlık : 1,543 kg / 3.402 lb Rotbaşı : VW2016 Rotmilî : VW3013	7H0419804 D, 7H0419804C 7H0419804D, 7H0419804F
	VW20173013 ROT TAKIMI ÖN AKS SOL RD088222	Ağırlık : 1,668 kg / 3.677 lb Rotbaşı : VW2017 Rotmilî : VW3013	7H0419803 D, 7H0419803D 7H0419804C
	VW4019 Z ROT SAĞ-SOL METAL RD0934	Ağırlık : 0,39 kg / 0.860 lb Malzeme Türü : Metal Uzunluk : 261 mm / 10.28 inch Aşık Diş Çapı : M12X1,5	1H0411317, 7H0411317 7H5411317, 7H5411317A 7H5411317B
	VW6037 SALINCAĞ ALT SAĞ RD1037	Ağırlık : 8,6 kg / 18.960 lb Malzeme Türü : Döküm Çelik	7H0407152E
	VW6038 SALINCAĞ ALT SOL RD1038	Ağırlık : 8,6 kg / 18.960 lb Malzeme Türü : Döküm Çelik	7H0407151E



* Bu sayfada ve katalogdaki tüm araçların adları, markaları, modelleri, sembolleri, logoları, orijinal numaraları (oe) ve diğer üçüncü parti numaraları sadece referans amaçlı kullanılmaktadır.

TRANSPORTER
V T5
2003 - 2011

Resim	Ürün Kodu ve Açıklaması	Detay	OEM
	VW6069 SALINCAK ALT SAĞ	Ağırlık : 8,915 kg / 19.654 lb Malzeme Türü : Döküm Çelik	7H8407152B
	VW6070 SALINCAK ALT SOL	Ağırlık : 8,915 kg / 19.654 lb Malzeme Türü : Döküm Çelik	7H8407151B
	VW11062 SALINCAK VE DENGE KOLU BURCU SOL VE SAĞ	Yön : Sol Ve Sağ Ağırlık : 0,294 kg / 0.648 lb	7H0407182A
	VW11064 SALINCAK VE DENGE KOLU BURCU ORTA SOL VE SAĞ B40130	Yön : Orta Sol Ve Sağ Ağırlık : 0.31 kg / 0.683 lb	2H0407183A, 7H0407183
	VW11072 SALINCAK VE DENGE KOLU BURCU ALT SOL VE SAĞ	Yön : Alt Sol Ve Sağ Ağırlık : 0.3 kg / 0.661 lb	7E8407151A*, 7E8407151A-P 7E8407151B*, 7E8407151B-P 7E8407152A*, 7E8407152A-P 7E8407152B*, 7E8407152B-P
	VW11073 SALINCAK VE DENGE KOLU BURCU ÖN ALT SOL VE SAĞ	Şasi (Ön / Arka) : ÖN Yön : Alt Sol Ve Sağ Ağırlık : 0.305 kg / 0.672 lb	7E8407151A*, 7E8407151A-P 7E8407151B*, 7E8407151B-P 7E8407152A*, 7E8407152A-P 7E8407152B*, 7E8407152B-P
	VW12160 BEŞİK (TRAVERS) BURCU ARKA SOL VE SAĞ	Şasi (Ön / Arka) : ARKA Yön : Sol Ve Sağ Ağırlık : 0,35 kg / 0.772 lb	7H0501131, 7H0501131A
	VW12042 VİRAJ DEMİR LASTİĞİ SOL VE SAĞ RUBBER	Şasi (Ön / Arka) : ÖN Yön : Sol Ve Sağ Ağırlık : 0.05 kg / 0.110 lb Malzeme Türü : Rubber Not : VİRAJ LASTİĞİ	7H5411313A, 7H5411313B
	VW12042K VİRAJ DEMİR LASTİĞİ SOL VE SAĞ RUBBER	Şasi (Ön / Arka) : ÖN Yön : Sol Ve Sağ Ağırlık : 0.1 kg / 0.220 lb Malzeme Türü : Rubber	7H5411313A*
	VW12063 VİRAJ DEMİR LASTİĞİ SOL VE SAĞ RUBBER	Şasi (Ön / Arka) : ÖN Yön : Sol Ve Sağ Ağırlık : 0.054 kg / 0.119 lb Malzeme Türü : Rubber Not : VİRAJ LASTİĞİ	7H0411313
	VW12063K VİRAJ DEMİR LASTİĞİ SOL VE SAĞ RUBBER	Şasi (Ön / Arka) : ÖN Yön : Sol Ve Sağ Ağırlık : 0.108 kg / 0.238 lb Malzeme Türü : Rubber	7H0411313*





* Bu sayfada ve katalogdaki tüm araçların adları, markaları, modelleri, sembolleri, logoları, orjinal numaraları (oe) ve diğer üçüncü parti numaraları sadece referans amaçlı kullanılmaktadır.

TRANSPORTER
V T5
2003 - 2011





Resim	Ürün Kodu ve Açıklaması	Detay	OEM
	VW12090 VİRAJ DEMİR LASTİĞİ SOL VE SAĞ RUBBER	Şasi (Ön / Arka) : ÖN Yön : Sol Ve Sağ Ağırlık : 0.04 kg / 0.088 lb Malzeme Türü : Rubber Not : VİRAJ LASTİĞİ ARKA Ø27	7H5511414A
	VW12090K VİRAJ DEMİR LASTİĞİ SOL VE SAĞ RUBBER	Şasi (Ön / Arka) : ÖN Yön : Sol Ve Sağ Ağırlık : 0.08 kg / 0.176 lb Malzeme Türü : Rubber	7H5511414A*
	VW12112 VİRAJ DEMİR LASTİĞİ SOL VE SAĞ RUBBER	Şasi (Ön / Arka) : ÖN Yön : Sol Ve Sağ Ağırlık : 0.05 kg / 0.110 lb Malzeme Türü : Rubber Not : VİRAJ LASTİĞİ	7H0511413A
	VW12112K VİRAJ DEMİR LASTİĞİ SOL VE SAĞ RUBBER	Şasi (Ön / Arka) : ÖN Yön : Sol Ve Sağ Ağırlık : 0.1 kg / 0.220 lb Malzeme Türü : Rubber	7H0511413A*
	VW12018 AMORTİSÖR TAKOZU SOL VE SAĞ AMORTİSÖR TAKOZU	Yön : Sol Ve Sağ Ağırlık : 0.556 kg / 1.226 lb Not : AMORTİSÖR TAKOZU	7E0412331
	VW12018K AMORTİSÖR TAKOZU SOL VE SAĞ AMORTİSÖR TAKOZU ÖN RULMANLI	Yön : Sol Ve Sağ Ağırlık : 0.815 kg / 1.797 lb Not : AMORTİSÖR TAKOZU ÖN RULMANLI	7E0412331, 7E0412331S1 7H0412249A
	VW12018R AMORTİSÖR TAKOZU SOL VE SAĞ AMORTİSÖR TAKOZU RULMANI	Yön : Sol Ve Sağ Ağırlık : 0.259 kg / 0.571 lb Not : AMORTİSÖR TAKOZU RULMANI	7E0412249, 7H0412249 7H0412249A
	VW12019 MOTOR TAKOZU SOL VE SAĞ MOTOR TAKOZU	Yön : Sol Ve Sağ Ağırlık : 0.685 kg / 1.510 lb Not : Motor takozu	7H0199848B, 7H0199848D 7H0199848G
	VW12023 ŞANZİMAN TAKOZU SOL VE SAĞ ŞANZİMAN TAKOZU ARKA	Yön : Sol Ve Sağ Ağırlık : 1.25 kg / 2.756 lb Not : ŞANZİMAN TAKOZU ARKA	7H0199849, 7H0199849AT
	SK12006 EGZOZ TAKOZU	Ağırlık : 0,185 kg / 0.408 lb	6Q0253144B, 6Q0253144D
	VW13004 RIW DİREKSİYON KÖRÜĞÜ	Ağırlık : 0.16 kg / 0.353 lb	7H0422831

* Bu sayfada ve katalogdaki tüm araçların adları, markaları, modelleri, sembolleri, logoları, orjinal numaraları (oe) ve diğer üçüncü parti numaraları sadece referans amaçlı kullanılmaktadır.

TRANSPORTER
V T5
2003 - 2011

Resim	Ürün Kodu ve Açıklaması	Detay	OEM
	RN14016 AKS KÖRÜĞÜ +KELEPÇE+YAĞ. DIŞ	Ağırlık : 0.26 kg / 0.573 lb	7701209568, 7H0498103E 7H0498202A
	VW14004 AKS KÖRÜĞÜ +KELEPÇE+YAĞ. DIŞ	Ağırlık : 0.43 kg / 0.948 lb	701407203 A, 701407203A
	VW14006 AKS KÖRÜĞÜ +KELEPÇE+YAĞ. DIŞ		19054140316
	VW14007 AKS KÖRÜĞÜ +KELEPÇE+YAĞ. İÇ		
	VW15001 AMORTİSÖR KÖRÜĞÜ ÖN	Şasi (Ön / Arka) : ÖN Ağırlık : 0,095 kg / 0.209 lb	7H0412137

TRANSPORTER
VI T5, FACELIFT
2011 - 2016

Resim	Ürün Kodu ve Açıklaması	Detay	OEM
	VW1024 ROTİL ALT SAĞ-SOL RD0534	Ağırlık : 0,611 kg / 1.347 lb Konik Ölçüsü : Ø18,3 Aşık Diş Çapı : M14X1,5	7E0407361, 7H0407361 7H0407361A
	VW2016 ROTBAŞI SAĞ RD0345	Ağırlık : 1,071 kg / 2.361 lb Uzunluk : 235 mm / 9.25 inch Gövde Diş Çapı : M16X1,5 Aşık Diş Çapı : M14X1,5 Aşık Konik Çapı : Ø16,6	1H0422818E, 7H0422818B 7H0422818C
	VW2017 ROTBAŞI SOL RD0344	Ağırlık : 1,062 kg / 2.341 lb Uzunluk : 235 mm / 9.25 inch Gövde Diş Çapı : M16X1,5 Aşık Diş Çapı : M14X1,5 Aşık Konik Çapı : Ø16,6	7H0422817, 7H0422817A 7H0422817B, 7H0422817C
	VW3013 ROTMİLİ SAĞ- SOL M16X1,5 RHT , L= 190 MM	Ağırlık : 0,57 kg / 1.257 lb Uzunluk : 177 mm / 6.97 inch Gövde Diş Çapı : M16X1,5 Aşık Diş Çapı : M16X1,5	7H0419 821D, 7H0419803C* 7H0419803D, 7H0419804C* 7H0422 817C
	VW20163013 ROT TAKIMI ÖN AKS SAĞ RD088221	Ağırlık : 1,543 kg / 3.402 lb Rotbaşı : VW2016 Rotmili : VW3013	7H0419804 D, 7H0419804C 7H0419804D, 7H0419804F







* Bu sayfada ve katalogdaki tüm araçların adları, markaları, modelleri, sembolleri, logoları, orjinal numaraları (oe) ve diğer üçüncü parti numaraları sadece referans amaçlı kullanılmaktadır.

TRANSPORTER
VI T5, FACELIFT
2011 - 2016



Resim	Ürün Kodu ve Açıklaması	Detay	OEM
	VW20173013 ROT TAKIMI ÖN AKS SOL RD088222	Ağırlık : 1,668 kg / 3.677 lb Rotbaşı : VW2017 Rotmilî : VW3013	7H0419803 D, 7H0419803D 7H0419804C
	VW4019 Z ROT SAĞ-SOL METAL RD0934	Ağırlık : 0,39 kg / 0.860 lb Malzeme Türü : Metal Uzunluk : 261 mm / 10.28 inch Aşık Diş Çapı : M12X1,5	1H0411317, 7H0411317 7H5411317, 7H5411317A 7H5411317B
	VW6057 SALINCAK ALT SAĞ	Ağırlık : 8,1 kg / 17.857 lb Malzeme Türü : Döküm Çelik	7E8407152A, 7E8407152B
	VW6058 SALINCAK ALT SOL	Ağırlık : 8,1 kg / 17.857 lb Malzeme Türü : Döküm Çelik	7E8407151A, 7E8407151B
	VW6061 SALINCAK ALT SAĞ	Ağırlık : 8,026 kg / 17.694 lb Malzeme Türü : Döküm Çelik	7E0407152B
	VW6062 SALINCAK ALT SOL	Ağırlık : 8,026 kg / 17.694 lb Malzeme Türü : Döküm Çelik	7E0407151C
	VW11072 SALINCAK VE DENGİ KOLU BURCU ALT SOL VE SAĞ	Yön : Alt Sol Ve Sağ Ağırlık : 0.3 kg / 0.661 lb	7E8407151A*, 7E8407151A-P 7E8407151B*, 7E8407151B-P 7E8407152A*, 7E8407152A-P 7E8407152B*, 7E8407152B-P
	VW11073 SALINCAK VE DENGİ KOLU BURCU ÖN ALT SOL VE SAĞ	Şasi (Ön / Arka) : ÖN Yön : Alt Sol Ve Sağ Ağırlık : 0.305 kg / 0.672 lb	7E8407151A*, 7E8407151A-P 7E8407151B*, 7E8407151B-P 7E8407152A*, 7E8407152A-P 7E8407152B*, 7E8407152B-P
	VW12160 BEŞİK (TRAVERS) BURCU ARKA SOL VE SAĞ	Şasi (Ön / Arka) : ARKA Yön : Sol Ve Sağ Ağırlık : 0,35 kg / 0.772 lb	7H0501131, 7H0501131A
	VW12063 VİRAJ DEMİR LASTİĞİ SOL VE SAĞ RUBBER	Şasi (Ön / Arka) : ÖN Yön : Sol Ve Sağ Ağırlık : 0.054 kg / 0.119 lb Malzeme Türü : Rubber Not : VİRAJ LASTİĞİ	7H0411313
	VW12063K VİRAJ DEMİR LASTİĞİ SOL VE SAĞ RUBBER	Şasi (Ön / Arka) : ÖN Yön : Sol Ve Sağ Ağırlık : 0.108 kg / 0.238 lb Malzeme Türü : Rubber	7H0411313*

* Bu sayfada ve katalogdaki tüm araçların adları, markaları, modelleri, sembolleri, logoları, orjinal numaraları (oe) ve diğer üçüncü parti numaraları sadece referans amaçlı kullanılmaktadır.

TRANSPORTER
VI T5, FACELIFT
2011 - 2016











Resim	Ürün Kodu ve Açıklaması	Detay	OEM
	VW12090 VİRAJ DEMİR LASTİĞİ SOL VE SAĞ RUBBER	Şasi (Ön / Arka) : ÖN Yön : Sol Ve Sağ Ağırlık : 0.04 kg / 0.088 lb Malzeme Türü : Rubber Not : VİRAJ LASTİĞİ ARKA Ø27	7H5511414A
	VW12090K VİRAJ DEMİR LASTİĞİ SOL VE SAĞ RUBBER	Şasi (Ön / Arka) : ÖN Yön : Sol Ve Sağ Ağırlık : 0.08 kg / 0.176 lb Malzeme Türü : Rubber	7H5511414A*
	VW12018 AMORTİSÖR TAKOZU SOL VE SAĞ AMORTİSÖR TAKOZU	Yön : Sol Ve Sağ Ağırlık : 0.556 kg / 1.226 lb Not : AMORTİSÖR TAKOZU	7E0412331
	VW12018K AMORTİSÖR TAKOZU SOL VE SAĞ AMORTİSÖR TAKOZU ÖN RULMANLI	Yön : Sol Ve Sağ Ağırlık : 0.815 kg / 1.797 lb Not : AMORTİSÖR TAKOZU ÖN RULMANLI	7E0412331, 7E0412331S1 7H0412249A
	VW12018R AMORTİSÖR TAKOZU SOL VE SAĞ AMORTİSÖR TAKOZU RULMANI	Yön : Sol Ve Sağ Ağırlık : 0.259 kg / 0.571 lb Not : AMORTİSÖR TAKOZU RULMANI	7E0412249, 7H0412249 7H0412249A
	SK12006 EGZOZ TAKOZU	Ağırlık : 0,185 kg / 0.408 lb	6Q0253144B, 6Q0253144D
	VW15001 AMORTİSÖR KÖRÜĞÜ ÖN	Şasi (Ön / Arka) : ÖN Ağırlık : 0,095 kg / 0.209 lb	7H0412137

TRANSPORTER
VII T6
2016 - 2021

Resim	Ürün Kodu ve Açıklaması	Detay	OEM
	VW1024 ROTİL ALT SAĞ-SOL RD0534	Ağırlık : 0,611 kg / 1.347 lb Konik Ölçüsü : Ø18,3 Aşık Diş Çapı : M14X1,5	7E0407361, 7H0407361 7H0407361A
	VW1030 ROTİL ALT	Ağırlık : 0,552 kg / 1.217 lb Konik Ölçüsü : Ø18,3 Bağlantı Delik Çapı : Ø13 Aşık Diş Çapı : M14X1,5	7H8407361, 7H8407361A
	VW1030K ROTİL ÖN ALT Ø18,3	Ağırlık : 0,600 kg / 1.323 lb Konik Ölçüsü : Ø18,3 Bağlantı Delik Çapı : Ø13 Aşık Diş Çapı : M14X1,5	7H8407361, 7H8407361A

* Bu sayfada ve katalogdaki tüm araçların adları, markaları, modelleri, sembolleri, logoları, orjinal numaraları (oe) ve diğer üçüncü parti numaraları sadece referans amaçlı kullanılmaktadır.

TRANSPORTER
VII T6
2016 - 2021

Resim	Ürün Kodu ve Açıklaması	Detay	OEM
	VW2016 ROTBAŞI SAĞ RD0345	Ağırlık : 1,071 kg / 2.361 lb Uzunluk : 235 mm / 9.25 inch Gövde Diş Çapı : M16X1,5 Aşık Diş Çapı : M14X1,5 Aşık Konik Çapı : Ø16,6	1H0422818E, 7H0422818B 7H0422818C
	VW2017 ROTBAŞI SOL RD0344	Ağırlık : 1,062 kg / 2.341 lb Uzunluk : 235 mm / 9.25 inch Gövde Diş Çapı : M16X1,5 Aşık Diş Çapı : M14X1,5 Aşık Konik Çapı : Ø16,6	7H0422817, 7H0422817A 7H0422817B, 7H0422817C
	VW3013 ROTMİLİ SAĞ- SOL M16X1,5 RHT , L= 190 MM	Ağırlık : 0,57 kg / 1.257 lb Uzunluk : 177 mm / 6.97 inch Gövde Diş Çapı : M16X1,5 Aşık Diş Çapı : M16X1,5	7H0419 821D, 7H0419803C* 7H0419803D, 7H0419804C* 7H0422 817C
	VW20163013 ROT TAKIMI ÖN AKS SAĞ RD088221	Ağırlık : 1,543 kg / 3.402 lb Rotbaşı : VW2016 Rotmilî : VW3013	7H0419804 D, 7H0419804C 7H0419804D, 7H0419804F
	VW20173013 ROT TAKIMI ÖN AKS SOL RD088222	Ağırlık : 1,668 kg / 3.677 lb Rotbaşı : VW2017 Rotmilî : VW3013	7H0419803 D, 7H0419803D 7H0419804C
	VW4019 Z ROT SAĞ-SOL METAL RD0934	Ağırlık : 0,39 kg / 0.860 lb Malzeme Türü : Metal Uzunluk : 261 mm / 10.28 inch Aşık Diş Çapı : M12X1,5	1H0411317, 7H0411317 7H5411317, 7H5411317A 7H5411317B
	VW6057 SALINCAK ALT SAĞ	Ağırlık : 8,1 kg / 17.857 lb Malzeme Türü : Döküm Çelik	7E8407152A, 7E8407152B
	VW6058 SALINCAK ALT SOL	Ağırlık : 8,1 kg / 17.857 lb Malzeme Türü : Döküm Çelik	7E8407151A, 7E8407151B
	VW11072 SALINCAK VE DENGE KOLU BURCU ALT SOL VE SAĞ	Yön : Alt Sol Ve Sağ Ağırlık : 0.3 kg / 0.661 lb	7E8407151A*, 7E8407151A-P 7E8407151B*, 7E8407151B-P 7E8407152A*, 7E8407152A-P 7E8407152B*, 7E8407152B-P
	VW11073 SALINCAK VE DENGE KOLU BURCU ÖN ALT SOL VE SAĞ	Şasi (Ön / Arka) : ÖN Yön : Alt Sol Ve Sağ Ağırlık : 0.305 kg / 0.672 lb	7E8407151A*, 7E8407151A-P 7E8407151B*, 7E8407151B-P 7E8407152A*, 7E8407152A-P 7E8407152B*, 7E8407152B-P
	VW12160 BEŞİK (TRAVERS) BURCU ARKA SOL VE SAĞ	Şasi (Ön / Arka) : ARKA Yön : Sol Ve Sağ Ağırlık : 0,35 kg / 0.772 lb	7H0501131, 7H0501131A

* Bu sayfada ve katalogdaki tüm araçların adları, markaları, modelleri, sembolleri, logoları, orjinal numaraları (oe) ve diğer üçüncü parti numaraları sadece referans amaçlı kullanılmaktadır.

TRANSPORTER
VII T6
2016 - 2021







Resim	Ürün Kodu ve Açıklaması	Detay	OEM
	VW15001 AMORTİSÖR KÖRÜĞÜ ÖN	Şasi (Ön / Arka) : ÖN Ağırlık : 0,095 kg / 0.209 lb	7H0412137

T-ROC
A11
2018 -

Resim	Ürün Kodu ve Açıklaması	Detay	OEM
	VW1014 ROTİL ÖN ALT SAĞ Ø15,6 RB2536	Ağırlık : 0,565 kg / 1.246 lb Konik Ölçüsü : Ø15,6 Bağlantı Delik Çapı : Ø10,5 Aşık Diş Çapı : M12X1,5	1K0407366B, 1K0407366C 1K0407366E, 5Q0407366A
	VW1015 ROTİL ÖN ALT SOL Ø15,6 RB2537	Ağırlık : 0,565 kg / 1.246 lb Konik Ölçüsü : Ø15,6 Bağlantı Delik Çapı : Ø10,5 Aşık Diş Çapı : M12X1,5	1K0407365B, 1K0407365C 1K0407365E, 5Q0407365A
	VW1031 ROTİL ÖN ALT SAĞ Ø15,2	Ağırlık : 0,59 kg / 1.301 lb Konik Ölçüsü : Ø15,2 Aşık Diş Çapı : M12X1,5	3C0407366B
	VW1032 ROTİL ÖN ALT SOL Ø15,2	Ağırlık : 0,59 kg / 1.301 lb Konik Ölçüsü : Ø15,2 Aşık Diş Çapı : M12X1,5	3C0407365B
	VW2008 ROTBAŞI ÖN SAĞ RD0342	Ağırlık : 0,412 kg / 0.908 lb Uzunluk : 95 mm / 3.74 inch Gövde Diş Çapı : M16X1,5 Aşık Diş Çapı : M12X1,5 Aşık Konik Çapı : Ø12,7	1K0423812A, 1K0423812C 1K0423812E, 1K0423812G 1K0423812J, 1K0423812K 1KD423812A
	VW2009 ROTBAŞI ÖN SOL RD0343	Ağırlık : 0,412 kg / 0.908 lb Uzunluk : 95 mm / 3.74 inch Gövde Diş Çapı : M16X1,5 Aşık Diş Çapı : M12X1,5 Aşık Konik Çapı : Ø13,5	1K0423811A, 1K0423811C 1K0423811E, 1K0423811G 1K0423811J, 1K0423811K 1KD423811A
	VW3009 ROTMİLİ SAĞ-SOL 310 RB2838	Ağırlık : 0,665 kg / 1.466 lb Uzunluk : 311 mm / 12.24 inch Gövde Diş Çapı : M16X1,5 Aşık Diş Çapı : M16X1,5	1K0423810A
	VW20083009 ROT TAKIMI ÖN AKS SAĞ RB288137	Ağırlık : 1,078 kg / 2.377 lb Rotbaşı : VW2008 Rotmili : VW3009	
	VW20093009 ROT TAKIMI ÖN SOL RB288138	Ağırlık : 1,077 kg / 2.374 lb Rotbaşı : VW2009 Rotmili : VW3009	







* Bu sayfada ve katalogdaki tüm araçların adları, markaları, modelleri, sembolleri, logoları, orijinal numaraları (oe) ve diğer üçüncü parti numaraları sadece referans amaçlı kullanılmaktadır.

T-ROC
A11
2018 -



Resim	Ürün Kodu ve Açıklaması	Detay	OEM
	VW4014 Z ROT ÖN SAĞ-SOL METAL 335 RB2935	Ağırlık : 0,46 kg / 1.014 lb Malzeme Türü : Metal Uzunluk : 335 mm / 13.19 inch Aşık Diş Çapı : M12X1,5	1K0411315B, 1K0411315D 1K0411315J, 1K0411315K 1K0411315R, 5Q0411315A 5Q0411315B
	VW4031 Z ROT ARKA PLASTİK	Ağırlık : 0,15 kg / 0.331 lb Malzeme Türü : Plastik Uzunluk : 70 mm / 2.76 inch Aşık Diş Çapı : M10X1,5	5Q0505465A, 5Q0505465C
	AU9009 SALINCAK ALT SOL VE SAĞ	Ağırlık : 2,910 kg / 6.415 lb Malzeme Türü : Sac Metal	5Q0505311C, 5Q0505311D
	AU9012 SALINCAK ARKA ALT SAĞ	Ağırlık : 1,640 kg / 3.616 lb Malzeme Türü : Sac Metal	5Q0505224D
	AU9013 SALINCAK ARKA ALT SOL	Ağırlık : 1,640 kg / 3.616 lb Malzeme Türü : Sac Metal	5Q0505223D
	VW6079 SALINCAK VE DENGE KOLU ÖN ALT SAĞ SAC LEVHA	Ağırlık : 3,624 kg / 7.990 lb Malzeme Türü : Sac Metal	5Q0407152T, 81A407152C 81A407152E, 81A407152F
	VW6079J SALINCAK VE DENGE KOLU ÖN ALT SAĞ SAC LEVHA	Ağırlık : 3,202 kg / 7.059 lb Malzeme Türü : Sac Metal	5Q0407154E, 5WA407151A 5WA407152A
	VW6080 SALINCAK VE DENGE KOLU ÖN ALT SOL SAC LEVHA	Ağırlık : 3,624 kg / 7.990 lb Malzeme Türü : Sac Metal	5Q0407151T, 81A407151C 81A407151E, 81A407151F
	VW6080J SALINCAK VE DENGE KOLU ÖN ALT SOL SAC LEVHA	Ağırlık : 3,202 kg / 7.059 lb Malzeme Türü : Sac Metal	5Q0407153E, 5WA407151A 5WA407152A
	VW9005 SALINCAK ARKA ALT ÖNDEN	Ağırlık : 0,566 kg / 1.248 lb Malzeme Türü : Sac Metal	5Q0501529C, 5Q0501529D 5Q0501529E, 5Q0501529F
	AU11068 SALINCAK VE DENGE KOLU BURCU ARKA ALT SOL VE SAĞ METAL	Şasi (Ön / Arka) : ARKA Yön : Alt Sol Ve Sağ Ağırlık : 0,201 kg / 0.443 lb Malzeme Türü : Metal	PART OF 5Q0505223D, PART OF 5Q0505224D

* Bu sayfada ve katalogdaki tüm araçların adları, markaları, modelleri, sembolleri, logoları, orjinal numaraları (oe) ve diğer üçüncü parti numaraları sadece referans amaçlı kullanılmaktadır.

T-ROC
A11
2018 -











Resim	Ürün Kodu ve Açıklaması	Detay	OEM
	AU11070 SALINCAK VE DENGE KOLU BURCU ARKA ALT	Şasi (Ön / Arka) : ARKA Yön : Alt Ağırlık : 0,100 kg / 0.220 lb	5Q0505171, 5Q0505311C 5Q0505311CSK, 5Q0505311D 5Q0505311DSK
	VW11042 SALINCAK VE DENGE KOLU BURCU ORTA SOL VE SAĞ	Yön : Orta Sol Ve Sağ Ağırlık : 0,182 kg / 0.401 lb	1K0407182, 5Q0407182
	VW11075 SALINCAK VE DENGE KOLU BURCU ARKA SOL VE SAĞ	Şasi (Ön / Arka) : ARKA Yön : Sol Ve Sağ Ağırlık : 0,870 kg / 1.918 lb Not : FORWARD and INNER	Part of 5Q0501529C, Part of 5Q0501529D Part of 5Q0501529E, Part of 5Q0501529F
	VW11076 SALINCAK VE DENGE KOLU BURCU ARKA SOL VE SAĞ	Şasi (Ön / Arka) : ARKA Yön : Sol Ve Sağ Ağırlık : 0,870 kg / 1.918 lb Not : FORWARD and OUTER	Part of 5Q0501529C, Part of 5Q0501529D Part of 5Q0501529E, Part of 5Q0501529F
	VW11183 SALINCAK VE DENGE KOLU BURCU ÖN ALT	Şasi (Ön / Arka) : ÖN Yön : Alt Ağırlık : 0,322 kg / 0.710 lb	5Q0407182F, 5Q0407183D 5Q0407183E, 5Q0407183J 5Q0407183L
	AU11080 BEŞİK (TRAVERS) BURCU ÖN ALT	Şasi (Ön / Arka) : ÖN Yön : Alt Ağırlık : 0,135 kg / 0.298 lb	5Q0505553
	SK12005 MOTOR TAKOZU ÖN SAĞ	Şasi (Ön / Arka) : ÖN Yön : Sağ Ağırlık : 1,575 kg / 3.472 lb	5Q0199262CK

UP
121, 122, BL1, BL2
2011 - 2016

Resim	Ürün Kodu ve Açıklaması	Detay	OEM
	SK1025 ROTİL SAĞ	Ağırlık : 0,59 kg / 1.301 lb Konik Ölçüsü : Ø15 Bağlantı Delik Çapı : Ø10,5 Aşık Diş Çapı : M12X1,5	5U0407366A, 6R0407366 6R0407366A, 6R0407366B
	SK1026 ROTİL ÖN ALT SOL Ø15	Ağırlık : 0,59 kg / 1.301 lb Konik Ölçüsü : Ø15 Bağlantı Delik Çapı : Ø10,5 Aşık Diş Çapı : M12X1,5	5U0407365A, 6R0407365 6R0407365A, 6R0407365B
	VW2024 ROTBAŞI SAĞ 94 MM	Ağırlık : 0,435 kg / 0.959 lb Uzunluk : 93,5 mm / 3.68 inch Gövde Diş Çapı : M14X1,5 Aşık Diş Çapı : M12X1,5 Aşık Konik Çapı : Ø13,4	1S0423812A

* Bu sayfada ve katalogdaki tüm araçların adları, markaları, modelleri, sembolleri, logoları, orjinal numaraları (oe) ve diğer üçüncü parti numaraları sadece referans amaçlı kullanılmaktadır.

UP
121, 122, BL1, BL2
2011 - 2016

Resim	Ürün Kodu ve Açıklaması	Detay	OEM
	VW2025 ROTBAŞI SOL 94 MM	Ağırlık : 0,435 kg / 0.959 lb Uzunluk : 93,5 mm / 3.68 inch Gövde Diş Çapı : M14X1,5 Aşık Diş Çapı : M12X1,5 Aşık Konik Çapı : Ø13,4	1S0423811A
	VW3020 ROTMİLİ SAĞ-SOL <<ÖZELLİK>> 306MM	Ağırlık : 0,576 kg / 1.270 lb Uzunluk : 306 mm / 12.05 inch Gövde Diş Çapı : M14X1,5 Aşık Diş Çapı : M14X1,5	1S0423810A
	VW20243020 ROT TAKIMI ÖN SAĞ	Ağırlık : 1,1 kg / 2.425 lb Rotbaşı : VW2024 Rotmili : VW3020	1S0423810A S1, 1S0423810A
	VW20253020 ROT TAKIMI ÖN SOL	Ağırlık : 1,1 kg / 2.425 lb Rotbaşı : VW2024 Rotmili : VW3020	1S0423810A S2, 1S0423810A
	AU4028 Z ROT ÖN	Ağırlık : 0,368 kg / 0.811 lb Malzeme Türü : Metal Uzunluk : 270 mm / 10.63 inch Aşık Diş Çapı : M10X1,5	6Q0411315L, 6Q0411315N 8Z0411315D
	SK4001 Z ROT ÖN METAL	Ağırlık : 0,357 kg / 0.787 lb Malzeme Türü : Metal Uzunluk : 270 mm / 10.63 inch Aşık Diş Çapı : M10X1,5	2Q0411315, 2Q0411315A 6Q0411315A, 6Q0411315E 6Q0411315F, 6Q0411315H 6Q0411315J, 6Q0411315M 6Q0411315P
	VW6047 SALINCAK ÖN SAĞ	Ağırlık : 2,65 kg / 5.842 lb Malzeme Türü : Sac Metal	1S0407152*
	VW6047J SALINCAK ÖN SAĞ	Ağırlık : 2,06 kg / 4.542 lb Malzeme Türü : Sac Metal	1S0407152
	VW6048 SALINCAK ÖN SOL	Ağırlık : 2,65 kg / 5.842 lb Malzeme Türü : Sac Metal	1S0407151*
	VW6048J SALINCAK ÖN SOL	Ağırlık : 2,06 kg / 4.542 lb Malzeme Türü : Sac Metal	1S0407151
	AU11002 SALINCAK VE DENGE KOLU BURCU ÖN SOL VE SAĞ B22117	Şasi (Ön / Arka) : ÖN Yön : Sol Ve Sağ Ağırlık : 0,108 kg / 0.238 lb	1J0407181, 1J0407181A

* Bu sayfada ve katalogdaki tüm araçların adları, markaları, modelleri, sembolleri, logoları, orjinal numaraları (oe) ve diğer üçüncü parti numaraları sadece referans amaçlı kullanılmaktadır.

UP 121, 122, BL1, BL2 2011 - 2016

Resim	Ürün Kodu ve Açıklaması	Detay	OEM
	AU11005 SALINCAK VE DENGE KOLU BURCU ÖN ORTA SOL VE SAĞ B40115	Şasi (Ön / Arka) : ÖN Yön : Orta Sol Ve Sağ Ağırlık : 0,111 kg / 0.245 lb Not : VW6014 - VW60614J	191407182, 357407182 357407182F
	SK12004 TORSİYON BURCU ARKA SOL VE SAĞ	Şasi (Ön / Arka) : ARKA Yön : Sol Ve Sağ Ağırlık : 0,335 kg / 0.739 lb	1S0501541B, 1S0501541F
	VW12103 AMORTİSÖR TAKOZU SOL VE SAĞ AMORTİSÖR ÜST TAKOZU	Yön : Sol Ve Sağ Ağırlık : 0.23 kg / 0.507 lb Not : AMORTİSÖR ÜST TAKOZU	1J0412331B, 1J0412331C
	SE12006 ŞANZİMAN TAKOZU SOL	Yön : Sol Ağırlık : 0,760 kg / 1.676 lb	1S0199555A
	VW12036 SÜSPANSİYON TAKOZU SOL VE SAĞ ARKA SÜSPANSİYON TAKOZU	Yön : Sol Ve Sağ Ağırlık : 1.591 kg / 3.508 lb Not : ARKA SÜSPANSİYON TAKOZU	6Q0512131B
	VW12086 RADYATÖR TAKOZU SOL VE SAĞ RADYATÖR ÜST LASTİĞİ	Yön : Sol Ve Sağ Ağırlık : 0.024 kg / 0.053 lb Not : RADYATÖR ÜST LASTİĞİ	1K0121367F

VENTO 1H2 1991 - 1998

Resim	Ürün Kodu ve Açıklaması	Detay	OEM
	VW1012 ROTİL ALT SOL VE SAĞ	Ağırlık : 0,353 kg / 0.778 lb Bağlantı Delik Çapı : Ø8,5	357407365, 357407365A
	VW1012K ROTİL ALT SAĞ-SOL 19 RD0515	Ağırlık : 0,445 kg / 0.981 lb Bağlantı Delik Çapı : Ø8,5	357407365, 357407365A* 357407365A, 357407365S 357407365-S1
	VW1013 ROTİL ÖN ALT Ø16,5 RD0519	Ağırlık : 0,415 kg / 0.915 lb Konik Ölçüsü : Ø16,5 Bağlantı Delik Çapı : Ø8,5 Aşık Diş Çapı : M12X1,5	1H0407365
	VW1013K ROTİL	Ağırlık : 0,495 kg / 1.091 lb Konik Ölçüsü : Ø16,5 Bağlantı Delik Çapı : Ø8,5 Aşık Diş Çapı : M12X1,5	1H0407365*, 1H0407365

* Bu sayfada ve katalogdaki tüm araçların adları, markaları, modelleri, sembolleri, logoları, orijinal numaraları (oe) ve diğer üçüncü parti numaraları sadece referans amaçlı kullanılmaktadır.

VENTO
1H2
1991 - 1998

Resim	Ürün Kodu ve Açıklaması	Detay	OEM
	VW3007 ROTMİLİ ÖN SAĞ - SOL 369 RD0823	Ağırlık : 0,703 kg / 1.550 lb Uzunluk : 369 mm / 14.53 inch Gövde Diş Çapı : M22X1,5 Aşık Diş Çapı : M14X1,5	1H0419821
	VW3008 ROTMİLİ SAĞ-SOL 371 RD0826	Ağırlık : 0,652 kg / 1.437 lb Uzunluk : 371 mm / 14.61 inch Gövde Diş Çapı : M14X1,5 Aşık Diş Çapı : M14X1,5	1H0422803, 1H0422804 1H0422821, 803419811
	VW20063007 ROT TAKIMI ÖN AKS SAĞ RD088121	Ağırlık : 1,003 kg / 2.211 lb Rotbaşı : VW2006 Rotmili : VW3007	1H0419804, 1H0419804A
	VW20063008 ROT TAKIMI ÖN AKS SAĞ RD088125	Ağırlık : 0,947 kg / 2.088 lb Rotbaşı : VW2006 Rotmili : VW3008	1H0422804, 1H0422804A
	VW20073007 ROT TAKIMI ÖN AKS SOL RD088122	Ağırlık : 1,006 kg / 2.218 lb Rotbaşı : VW2007 Rotmili : VW3007	1H0419803, 357419803A
	VW20073008 ROT TAKIMI SOL RD088124	Ağırlık : 0,956 kg / 2.108 lb Rotbaşı : VW2007 Rotmili : VW3008	1H0422803
	VW4008 Z ROT ÖN SAĞ - SOL METAL RD0923	Ağırlık : 0,166 kg / 0.366 lb Malzeme Türü : Metal Uzunluk : 77 mm / 3.03 inch Aşık Diş Çapı : M8X1,25	191411315A, 191411315B 191411315BK
	VW4009 Z ROT ÖN SAĞ-SOL METAL 51 RD0911	Ağırlık : 0,15 kg / 0.331 lb Malzeme Türü : Metal Uzunluk : 51 mm / 2.01 inch Aşık Diş Çapı : M10X1,5	535411315
	VW4023 Z ROT ÖN SAĞ - SOL	Ağırlık : 0,195 kg / 0.430 lb Uzunluk : 78 mm / 3.07 inch Aşık Diş Çapı : M12X1,5	191411315A, 191411327
	VW6012 SALINCAK ALT SAĞ S725	Ağırlık : 2,754 kg / 6.072 lb Malzeme Türü : Sac Metal	191407153, 1H0407151
	VW60126013K SALINCAK ÖN	Ağırlık : 3.15 kg / 6.945 lb Malzeme Türü : Sac Metal	

* Bu sayfada ve katalogdaki tüm araçların adları, markaları, modelleri, sembolleri, logoları, orjinal numaraları (oe) ve diğer üçüncü parti numaraları sadece referans amaçlı kullanılmaktadır.

VENTO
1H2
1991 - 1998

Resim	Ürün Kodu ve Açıklaması	Detay	OEM
	VW6012J SALINCAK ÖN SAĞ - SOL RD1104	Ağırlık : 2,32 kg / 5.115 lb Malzeme Türü : Sac Metal	1H0407151
	VW6013 SALINCAK ALT SOL S726	Ağırlık : 2,754 kg / 6.072 lb Malzeme Türü : Sac Metal	191407151A, 1H0407151 1H0407152
	VW6014 SALINCAK ÖN SAĞ RD1021	Ağırlık : 3,966 kg / 8.744 lb Malzeme Türü : Sac Metal	1H0407152*
	VW6014J SALINCAK ÖN SAĞ RD1106	Ağırlık : 3,35 kg / 7.385 lb Malzeme Türü : Sac Metal	1H0407152
	VW6015 SALINCAK ÖN SOL RD1022	Ağırlık : 3,674 kg / 8.100 lb Malzeme Türü : Sac Metal	1H0407151A *, 1H0407151A*
	VW6015J SALINCAK ÖN SOL RD1105	Ağırlık : 3,152 kg / 6.949 lb Malzeme Türü : Sac Metal	1H0.407.151A, 1H0407151 1H0407151A
	AU11005 SALINCAK VE DENGE KOLU BURCU ÖN ORTA SOL VE SAĞ B40115	Şasi (Ön / Arka) : ÖN Yön : Orta Sol Ve Sağ Ağırlık : 0,111 kg / 0.245 lb Not : VW6014 - VW60614J	191407182, 357407182 357407182F
	VW11001 SALINCAK VE DENGE KOLU BURCU SOL VE SAĞ B40114	Yön : Sol Ve Sağ Ağırlık : 0.141 kg / 0.311 lb	191407181D, 191407181E 357407181
	VW11036 SALINCAK VE DENGE KOLU BURCU SOL VE SAĞ	Yön : Sol Ve Sağ Ağırlık : 0.07 kg / 0.154 lb Not : BORUSU	191411315B, 4A0399413A
	VW11840 BURÇ	Yön : Sol Ve Sağ Ağırlık : 0,149 kg / 0.328 lb	357407181
	VW11069 Z-ROT BURCU ÖN	Şasi (Ön / Arka) : ÖN Ağırlık : 0,035 kg / 0.077 lb Z Rot 1 : VW4009	535411315

* Bu sayfada ve katalogdaki tüm araçların adları, markaları, modelleri, sembolleri, logoları, orjinal numaraları (oe) ve diğer üçüncü parti numaraları sadece referans amaçlı kullanılmaktadır.

VENTO
1H2
1991 - 1998

Resim	Ürün Kodu ve Açıklaması	Detay	OEM
	VW12012 BEŞİK (TRAVERS) BURCU ARKA SOL VE SAĞ	Şasi (Ön / Arka) : ARKA Yön : Sol Ve Sağ Ağırlık : 0,63 kg / 1.389 lb	1H0501541A
	VW12012K BEŞİK (TRAVERS) BURCU ARKA SOL VE SAĞ	Şasi (Ön / Arka) : ARKA Yön : Sol Ve Sağ Ağırlık : 1,260 kg / 2.778 lb	1H0501541A
	VW12013 BEŞİK (TRAVERS) BURCU ARKA SOL VE SAĞ	Şasi (Ön / Arka) : ARKA Yön : Sol Ve Sağ Ağırlık : 1,380 kg / 3.042 lb	1H0501541A
	VW12053 VİRAJ DEMİR LASTİĞİ SOL VE SAĞ RUBBER	Şasi (Ön / Arka) : ÖN Yön : Sol Ve Sağ Ağırlık : 0.06 kg / 0.132 lb Malzeme Türü : Rubber Not : VİRAJ LASTİĞİ	1H0411314
	VW12053K VİRAJ DEMİR LASTİĞİ SOL VE SAĞ RUBBER	Şasi (Ön / Arka) : ÖN Yön : Sol Ve Sağ Ağırlık : 0.12 kg / 0.265 lb Malzeme Türü : Rubber	1H0411314*
	VW12111 VİRAJ DEMİR LASTİĞİ SOL VE SAĞ RUBBER	Şasi (Ön / Arka) : ÖN Yön : Sol Ve Sağ Ağırlık : 0.015 kg / 0.033 lb Malzeme Türü : Rubber Not : VİRAJ LASTİĞİ	191411329, 6N0411329
	VW12111K VİRAJ DEMİR LASTİĞİ SOL VE SAĞ RUBBER	Şasi (Ön / Arka) : ÖN Yön : Sol Ve Sağ Ağırlık : 0.03 kg / 0.066 lb Malzeme Türü : Rubber	191411329*, 6N0411329*
	VW12001 AMORTİSÖR TAKOZU SOL VE SAĞ AMARTİSÖR TAKOZU	Yön : Sol Ve Sağ Ağırlık : 0.644 kg / 1.420 lb Not : AMARTİSÖR TAKOZU	176412329, 191412329 191412331
	VW12005 AMORTİSÖR TAKOZU SOL VE SAĞ AMORTİSÖR ÜST TAKOZU	Yön : Sol Ve Sağ Ağırlık : 0.1 kg / 0.220 lb Not : AMORTİSÖR ÜST TAKOZU	191512333
	VW12058 AMORTİSÖR TAKOZU SOL VE SAĞ	Yön : Sol Ve Sağ Ağırlık : 0.654 kg / 1.442 lb	357412329
	VW12065 AMORTİSÖR TAKOZU SOL VE SAĞ AMORTİSÖR KEPİ	Yön : Sol Ve Sağ Ağırlık : 0.377 kg / 0.831 lb Not : AMORTİSÖR KEPİ	191 512 113, 191512113

* Bu sayfada ve katalogdaki tüm araçların adları, markaları, modelleri, sembolleri, logoları, orjinal numaraları (oe) ve diğer üçüncü parti numaraları sadece referans amaçlı kullanılmaktadır.

VENTO
1H2
1991 - 1998

Resim	Ürün Kodu ve Açıklaması	Detay	OEM
	VW12065K AMORTİSÖR TAKOZU ÖN SOL VE SAĞ 2 PCS	Şasi (Ön / Arka) : ÖN Yön : Sol Ve Sağ Ağırlık : 0.758 kg / 1.671 lb Not : 2 PCS	191512113
	VW12008 MOTOR TAKOZU SOL VE SAĞ MOTOR TAKOZU	Yön : Sol Ve Sağ Ağırlık : 0.574 kg / 1.265 lb Not : MOTOR TAKOZU	357199381C, 357199402B 3A0199402
	VW12074 MOTOR TAKOZU SOL VE SAĞ MOTOR TAKOZU	Yön : Sol Ve Sağ Ağırlık : 1.08 kg / 2.381 lb Not : MOTOR TAKOZU	1H0199609B, 1H0199609F 1H0199609G, 1H0199609J
	VW12092 MOTOR TAKOZU SAĞ MOTOR TAKOZU ARKA SAĞ	Yön : Sağ Ağırlık : 1,745 kg / 3.847 lb Not : MOTOR TAKOZU ARKA SAĞ	1H0199262B, 1H0199262G 1H0199262H
	VW12098 MOTOR TAKOZU SOL VE SAĞ MOTOR TAKOZU	Yön : Sol Ve Sağ Ağırlık : 1,565 kg / 3.450 lb Not : MOTOR TAKOZU	1H0199262E
	VW12088 SÜSPANSİYON TAKOZU SOL VE SAĞ SÜSPANSİYON TAKOZU ARKA	Yön : Sol Ve Sağ Ağırlık : 0.11 kg / 0.243 lb Not : SÜSPANSİYON TAKOZU ARKA	191512131B
	VW12089 SÜSPANSİYON TAKOZU SOL VE SAĞ SÜSPANSİYON TAKOZU	Yön : Sol Ve Sağ Ağırlık : 0.15 kg / 0.331 lb Not : SÜSPANSİYON TAKOZU	191412303A, 357412303E
	VW12135 EGZOZ TAKOZU	Ağırlık : 0,155 kg / 0.342 lb	1H0253144, 1H0253144A 1H0253144C, 1H0253409C 6N0253144
	VW13008 DİREKSİYON KÖRÜĞÜ	Ağırlık : 0.225 kg / 0.496 lb	1H0422831B
	VW13010 DİREKSİYON KÖRÜĞÜ ÖN	Ağırlık : 0,124 kg / 0.273 lb	191422831
	OP14003 AKS KÖRÜĞÜ +KELEPÇE+YAĞ. AKS KÖRÜĞÜ DIŞ	Ağırlık : 0.2 kg / 0.441 lb	1603180

* Bu sayfada ve katalogdaki tüm araçların adları, markaları, modelleri, sembolleri, logoları, orjinal numaraları (oe) ve diğer üçüncü parti numaraları sadece referans amaçlı kullanılmaktadır.

VENTO 1H2 1991 - 1998

Resim	Ürün Kodu ve Açıklaması	Detay	OEM
	RN14006 AKS KÖRÜĞÜ +KELEPÇE+YAĞ. DIŞ	Ağırlık : 0.2 kg / 0.441 lb	1603180, 1603204 16410170470106*, 16500170470106* 1H0498203, 271648 271649, 321498203A 431498203C, 443498203D
	VW14013 AKS KÖRÜĞÜ +KELEPÇE+YAĞ. YAĞ+KELEPÇE	Ağırlık : 0.156 kg / 0.344 lb	113501149, 171407283A
	VW14014 AKS KÖRÜĞÜ +KELEPÇE+YAĞ. YAĞ+KELEPÇE	Ağırlık : 0.28 kg / 0.617 lb	191498203C, 71498203

VENTO MEXICO 2014 - 2017



Resim	Ürün Kodu ve Açıklaması	Detay	OEM
	SK1025 ROTİL SAĞ	Ağırlık : 0,59 kg / 1.301 lb Konik Ölçüsü : Ø15 Bağlantı Delik Çapı : Ø10,5 Aşık Diş Çapı : M12X1,5	5U0407366A, 6R0407366 6R0407366A, 6R0407366B
	SK1026 ROTİL ÖN ALT SOL Ø15	Ağırlık : 0,59 kg / 1.301 lb Konik Ölçüsü : Ø15 Bağlantı Delik Çapı : Ø10,5 Aşık Diş Çapı : M12X1,5	5U0407365A, 6R0407365 6R0407365A, 6R0407365B
	SK2003 ROTBAŞI SAĞ RC7314	Ağırlık : 0,377 kg / 0.831 lb Uzunluk : 93,5 mm / 3.68 inch Gövde Diş Çapı : M14X1,5 Aşık Diş Çapı : M12X1,5 Aşık Konik Çapı : Ø13,5	5Z0423812, 6Q0419812C 6Q0423812, 6Q0423812A 6Q0423812C, 6Q0423812D 6R0423812, 8Z0423811A
	SK2004 ROTBAŞI SOL RC7313	Ağırlık : 0,382 kg / 0.842 lb Uzunluk : 93 mm / 3.66 inch Gövde Diş Çapı : M14X1,5 Aşık Diş Çapı : M12X1,5 Aşık Konik Çapı : Ø13,5	5Z0423811, 6Q0419811C 6Q0423811, 6Q0423811A 6Q0423811C, 6Q0423811D 6R0423811, 8Z0423812A
	AU3001 ROTMİLİ SOL VE SAĞ 318 RD0908	Ağırlık : 0,622 kg / 1.371 lb Uzunluk : 318 mm / 12.52 inch Gövde Diş Çapı : M16X1,5 Aşık Diş Çapı : M14X1,5	1J0422803B, 1J0422804B 1J0422804E, 1J0422807 1J0422807B, 1J0422821B
	AU3012 ROTMİLİ SAĞ-SOL M14X1,5 L=312MM	Ağırlık : 0,6 kg / 1.323 lb Uzunluk : 312 mm / 12.28 inch Gövde Diş Çapı : M14X1,5 Aşık Diş Çapı : M14X1,5	6C0423810A, 6C0423810B 6C0423810C
	AU4028 Z ROT ÖN	Ağırlık : 0,368 kg / 0.811 lb Malzeme Türü : Metal Uzunluk : 270 mm / 10.63 inch Aşık Diş Çapı : M10X1,5	6Q0411315L, 6Q0411315N 8Z0411315D

* Bu sayfada ve katalogdaki tüm araçların adları, markaları, modelleri, sembolleri, logoları, orjinal numaraları (oe) ve diğer üçüncü parti numaraları sadece referans amaçlı kullanılmaktadır.

VENTO MEXICO 2014 - 2017

Resim	Ürün Kodu ve Açıklaması	Detay	OEM
	VW6034 SALINCAK ÖN SAĞ	Ağırlık : 3,495 kg / 7.705 lb Malzeme Türü : Sac Metal	6R0407152A**, 6R0407152A 6R0407152B**, 6R0407152C** 6R0407152C, 6R0407152E 6R0407152F**
	VW6034J SALINCAK ÖN SAĞ	Ağırlık : 3 kg / 6.614 lb Malzeme Türü : Sac Metal	6R0407152A, 6R0407152B 6R0407152C, 6R0407152F
	VW6035 SALINCAK ÖN SOL	Ağırlık : 3,495 kg / 7.705 lb Malzeme Türü : Sac Metal	6R0407151A**, 6R0407151A 6R0407151B**, 6R0407151C** 6R0407151C, 6R0407151E 6R0407151F**
	VW6035J SALINCAK ÖN SOL	Ağırlık : 3,5 kg / 7.716 lb Malzeme Türü : Sac Metal	6R0407151A, 6R0407151B 6R0407151C, 6R0407151F
	AU11002 SALINCAK VE DENGE KOLU BURCU ÖN SOL VE SAĞ B22117	Şasi (Ön / Arka) : ÖN Yön : Sol Ve Sağ Ağırlık : 0,108 kg / 0.238 lb	1J0407181, 1J0407181A
	AU11005 SALINCAK VE DENGE KOLU BURCU ÖN ORTA SOL VE SAĞ B40115	Şasi (Ön / Arka) : ÖN Yön : Orta Sol Ve Sağ Ağırlık : 0,111 kg / 0.245 lb Not : VW6014 - VW60614J	191407182, 357407182 357407182F

VENTO VENTO 1H2 1991 - 1998





Resim	Ürün Kodu ve Açıklaması	Detay	OEM
	VW2006 ROTBAŞI SAĞ RD0312	Ağırlık : 0,3 kg / 0.661 lb Uzunluk : 76 mm / 2.99 inch Gövde Diş Çapı : M14X1,5 Aşık Diş Çapı : M12X1,5 Aşık Konik Çapı : Ø12,7	191419812, 22190091617 6N0419812, 6N0422812 XA2087
	VW2007 ROTBAŞI SOL RD0311	Ağırlık : 0,3 kg / 0.661 lb Uzunluk : 76 mm / 2.99 inch Gövde Diş Çapı : M14X1,5 Aşık Diş Çapı : M12X1,5 Aşık Konik Çapı : Ø12,7	191419811, 22190090617 6N0419811, 6N0422811 XA2084

VOYAGE 2008 -

Resim	Ürün Kodu ve Açıklaması	Detay	OEM
	SK1025 ROTİL SAĞ	Ağırlık : 0,59 kg / 1.301 lb Konik Ölçüsü : Ø15 Bağlantı Delik Çapı : Ø10,5 Aşık Diş Çapı : M12X1,5	5U0407366A, 6R0407366 6R0407366A, 6R0407366B

* Bu sayfada ve katalogdaki tüm araçların adları, markaları, modelleri, sembolleri, logoları, orjinal numaraları (oe) ve diğer üçüncü parti numaraları sadece referans amaçlı kullanılmaktadır.

VOYAGE**2008 -**

Resim	Ürün Kodu ve Açıklaması	Detay	OEM
	SK1026 ROTİL ÖN ALT SOL Ø15	Ağırlık : 0,59 kg / 1.301 lb Konik Ölçüsü : Ø15 Bağlantı Delik Çapı : Ø10,5 Aşık Diş Çapı : M12X1,5	5U0407365A, 6R0407365 6R0407365A, 6R0407365B
	SK2003 ROTBAŞI SAĞ RC7314	Ağırlık : 0,377 kg / 0.831 lb Uzunluk : 93,5 mm / 3.68 inch Gövde Diş Çapı : M14X1,5 Aşık Diş Çapı : M12X1,5 Aşık Konik Çapı : Ø13,5	5Z0423812, 6Q0419812C 6Q0423812, 6Q0423812A 6Q0423812C, 6Q0423812D 6R0423812, 8Z0423811A
	SK2004 ROTBAŞI SOL RC7313	Ağırlık : 0,382 kg / 0.842 lb Uzunluk : 93 mm / 3.66 inch Gövde Diş Çapı : M14X1,5 Aşık Diş Çapı : M12X1,5 Aşık Konik Çapı : Ø13,5	5Z0423811, 6Q0419811C 6Q0423811, 6Q0423811A 6Q0423811C, 6Q0423811D 6R0423811, 8Z0423812A
	SE3001 ROTMİLİ	Ağırlık : 0,63 kg / 1.389 lb Uzunluk : 320 mm / 12.60 inch Gövde Diş Çapı : M14X1,5 Aşık Diş Çapı : M14X1,5	6Q0423803E*, 6Q0423804E* 6Q0423810E*, 6Q0423810P*

RIW[®]

NOTLAR

Ürün Kodu	Bilgi Notu
AU1002 ROTİL ÖN SAĞ - SOL RB2512	MANUAL STEERING
AU1013 ROTİL ÖN ALT SAĞ - SOL Ø15,5 RB2535	FOR QUATTRO A3-S3 ONLY: 2001 -
AU1014K ROTİL ÖN SAĞ Ø15 RB2530	WITH CONNECTING METAL
AU1015K ROTİL ÖN SOL Ø15 RB2529	WITH CONNECTING METAL
AU11007 SALINCAK VE DENGİ KOLU BURCU ÖN ALT SOL VE SAĞ	HYDROLIC
AU11091 ROTMİLİ BURCU VE LASTİĞİ	SEMI-FINISHED PRODUCT
AU12007K VİRAJ DEMİR LASTİĞİ SOL VE SAĞ RUBBER	ONLY: 80 1,3 - 2,23
AU12008 VİRAJ DEMİR LASTİĞİ SOL VE SAĞ RUBBER	ONLY: 1,6 - 2,8
AU12008K VİRAJ DEMİR LASTİĞİ SOL VE SAĞ RUBBER	ONLY: 1,6 - 2,8
AU12012 EGZOZ TAKOZU ÖN SOL VE SAĞ EGSOZ LASTİĞİ	FOR EXHAUST SYSTEM
AU12019K MOTOR TAKOZU SOL VE SAĞ MOTOR TAKOZU TAKIM	KIT = AU12019 and AU12020
AU12026 MOTOR TAKOZU ÖN SOL VE SAĞ	AUDI A3 : 1,6 TDI - 2,0 TDI / AUDI TT : 1,8 TFSI - 2,0 TFSI / SEAT LEON: PDT - PFL - PFN / VW GOLF VII AND TOURAN : 1,4 TSI - 1,6 TDI - 2,0 TSI - 2,0 TDI / VW TOURAN : 1,6 TDI - 2,0 TDI / SEAT ATECA : 1,0 TSI - 1,6 TDI - 2,0 TDI /
AU12035 ŞANZİMAN TAKOZU	HYDRAULIC
AU14001 AKS KÖRÜĞÜ +KELEPÇE+YAĞ.	SET = BELOW, CLAMPING CLIP and MOLYBDENUM GREASE
AU20093001 ROT TAKIMI SAĞ	CH. NO: 8L.W-050-423 -->
AU20103001 ROT TAKIMI SOL	CH. NO: 8L.W-050-423 -->
AU2214 ROTBAŞI ÖN SAĞ - SOL RB2214	CH. NO: .-> 8D-W-260192 -> 8D-W-152089

Ürün Kodu	Bilgi Notu
AU2214A ROTBAŞI SAĞ-SOL (KOMPLE DEMİR) RB2225	YEAR: 2001-->
AU2214A3002 ROT TAKIMI ÖN AKS RB288136	YEAR: 2001-->
AU2318 ROTBAŞI SOL KISA RB2318	CH. NO:-->8L-W-050-422
AU23183003 ROT TAKIMI SAĞ RB288113	CH. NO:--> 8L-W-050-422
AU2319 ROTBAŞI SAĞ KISA RB2319	CH. NO:--> 8L-W-050-422
AU23193003 ROT TAKIMI SOL RB288112	CH. NO:--> 8L-W-050-422
AU3001 ROTMİLİ SOL VE SAĞ 318 RD0908	CH. NO: 8L-W-050-423 ->
AU3003 ROTMİLİ SAĞ-SOL UZUN L 360 MM RB2811	CHASSIS: -> 8L-W-050-422
AU4008 Z ROT ÖN SAĞ ALİMİNYUM 90 RB2921	WITH BOLTS and NUTS
AU4009 Z ROT ÖN SOL ALİMİNYUM 90 RB2920	WITH BOLTS and NUTS
AU4010 Z ROT ÖN SAĞ-SOL ALİMİNYUM 90 RB2912	WITH BOLTS and NUTS
AU4042 Z ROT SAĞ METAL	CHASSIS NO FROM 4L8030301
AU4043 Z ROT SOL METAL	CHASSIS NO FROM 4L8030301
AU5007A SALINCAK ÖN ÜST SAĞ RB2629	CH. NO: 8D-W-006471 --> and 8D-X-200001 -->
AU5008A SALINCAK ÖN ÜST SOL RB2628	CH. NO: 8D-W-006471 --> and 8D-X-200001 -->
AU5009A SALINCAK ÖN ÜST SAĞ RB2635	CH. NO: 8D-W-006471 --> and 8D-X-200001 -->
AU5010A SALINCAK ÖN ÜST SOL RB2634	CH. NO: 8D-W-006471 --> and 8D-X-200001 -->

Ürün Kodu	Bilgi Notu
AU5085 SALINCAK ÖN ÜST ÖNDEN SAĞ	ONLY FOR SPORT SUSPENSION
AU5086 SALINCAK ÖN ÜST ÖNDEN SOL	ONLY FOR SPORT SUSPENSION
AU5087 SALINCAK ÖN ÜST ARKADAN SAĞ	ONLY FOR SPORT SUSPENSION
AU5088 SALINCAK ÖN ÜST ARKADAN SOL	ONLY FOR SPORT SUSPENSION
AU8001 SÜSPANSİYON KİT ÖN	AU2214 (X2) / AU5013 (X2) / OTHER (X1)
AU8002 SÜSPANSİYON KİT ÖN	AU2214 (X2) / AU5013B (X2) / OTHER (X1)
AU9031 SALINCAK VE DENGİ KOLU ARKA ÜST SAĞ ALÜMİNYUM	FOR AIR SUSPENSION
AU9032 SALINCAK VE DENGİ KOLU ARKA ÜST SOL ALÜMİNYUM	FOR AIR SUSPENSION
BW2013 ROTBAŞI SAĞ RB3213	OUTER
BW2014 ROTBAŞI RB3214	INNER
CY12005 MOTOR TAKOZU ÖN	YEARS ONLY : 2008-2010
CY12006 MOTOR TAKOZU ÖN SOL	YEARS ONLY : 2008-2010
CY3007 ROTMİLİ ÖN SAĞ - SOL 358	CHRYSLER TOWN & COUNTRY: 2011 - 2016 / DODGE GRAND CARAVAN: 2011 - 2016
FI14009 AKS KÖRÜĞÜ +KELEPÇE+YAĞ. DIŞ	SET = BELOW, CLAMPING CLIP and MOLYBDENUM GREASE / 1.9JTD
FI14014 AKS KÖRÜĞÜ +KELEPÇE+YAĞ. DIŞ	SET = BELOW, CLAMPING CLIP, MOLYBDENUM GREASE / 1.3
ME12008K VİRAJ DEMİR LASTİĞİ SOL VE SAĞ RUBBER	2 PCS
ME12035K Z-ROT BURCU ÖN KAÇUK	2 Pieces In 1 Box

Ürün Kodu	Bilgi Notu
ME12060K VİRAJ DEMİR LASTİĞİ RUBBER	2 Pieces
ME8005 SÜSPANSİYON KİT ÖN	ME2023 (X2) / ME3008 (X2) / OTHERS (X1)
ME8006 SÜSPANSİYON KİT ÖN	ME2035 (X2) / ME3011 (X2) / OTHERS (X1)
OP14003 AKS KÖRÜĞÜ +KELEPÇE+YAĞ. AKS KÖRÜĞÜ DIŞ	SET = BELOW, CLAMPING CLIP and MOLYBDENUM GREASE / OUTER
OP14017 AKS KÖRÜĞÜ +KELEPÇE+YAĞ. DIŞ	SET = BELOW, CLAMPING CLIP and MOLYBDENUM GREASE / OUTER
RN14006 AKS KÖRÜĞÜ +KELEPÇE+YAĞ. DIŞ	SET = BELOW, CLAMPING CLIP and MOLYBDENUM GREASE / OUTER
RN14016 AKS KÖRÜĞÜ +KELEPÇE+YAĞ. DIŞ	SET = BELOW, CLAMPING CLIP and MOLYBDENUM GREASE / OUTER
RN14017 AKS KÖRÜĞÜ +KELEPÇE+YAĞ. DIŞ	SET = BELOW, CLAMPING CLIP and MOLYBDENUM GREASE / OUTER
SE12001 MOTOR TAKOZU ÖN SOL VE SAĞ	AUDI A1 YEARS ONLY: 2014-2018 / SEAT IBIZA ONLY: IV 2015-2017 / 1,4 TDI / VOLKSWAGEN POLO YEARS ONLY: 2014 -
SE12002 MOTOR TAKOZU ÖN SOL VE SAĞ	SEAT IBIZA ONLY: IV 2015 -2017 / VOLKSWAGEN POLO YEARS ONLY: 2014 -
SE12003 MOTOR TAKOZU ÖN SOL VE SAĞ	1,0 - 1,2 TSI / SEAT IBIZA ONLY: IV 2015 - / VOLKSWAGEN POLO YEARS ONLY: 2014 -
SE12004 MOTOR TAKOZU ÖN SOL VE SAĞ	AUDI A1 YEARS ONLY: 2014-2018 / SEAT IBIZA ONLY: IV 2015-2017 / 1,4 TDI / VOLKSWAGEN POLO YEARS ONLY: 2014 -
SE12005 MOTOR TAKOZU ARKA	SEAT IBIZA YEARS ONLY : 2002-2005
SE2003 ROTBAŞI SAĞ	FOR VEHICLES WITH POWER STEERING
SE20033002 ROT TAKIMI ÖN AKS SAĞ	FOR VEHICLES WITH POWER STEERING
SE2004 ROTBAŞI SOL	FOR VEHICLES WITH POWER STEERING
SE20043002 ROT TAKIMI ÖN AKS SOL	FOR VEHICLES WITH POWER STEERING

Ürün Kodu	Bilgi Notu
SE3001 ROTMİLİ	ONLY: 2001-2003
SK12002 AMORTİSÖR TAKOZU ARKA SOL VE SAĞ 1.2 / 1.4TSI / 1.6TDI / 1.2TDI	1.2 / 1.4TSI / 1.6TDI / 1.2TDI
SK12003K VİRAJ DEMİR LASTİĞİ SOL VE SAĞ RUBBER	2 PIECES IN 1 BOX
SK12005 MOTOR TAKOZU ÖN SAĞ	FOR 1.0 TSI
SK20033003 ROT TAKIMI ÖN AKS SAĞ RC788115	*T STEERING
SK20033004 ROT TAKIMI ÖN AKS SAĞ RC788117	KOYO STEERING
SK20043003 ROT TAKIMI SOL RC788114	*T STEERING
SK20043004 ROT TAKIMI ÖN AKS SOL RC788116	KOYO STEERING
SK2006 ROTBAŞI SAĞ	FACELIFT
SK2007 ROTBAŞI SOL	FACELIFT
SK3003 ROTMİLİ SAĞ-SOL 297	*T STEERING
SK3004 ROTMİLİ SAĞ-SOL 300 RC7817	KOYO STEERING
SK3007 ROTMİLİ SAĞ-SOL	KOYO STEERING
SK8001 SÜSPANSİYON KİT	SK3003 (X2) / AU4001 (X2) / OTHERS (X1)
TO2033 ROTBAŞI INNER RE3231	INNER
TO6028J SALINCAK ÖN ALT SAĞ	YEAR: 1988-->
TO6029J SALINCAK ÖN ALT SOL	YEAR: 1988-->

Ürün Kodu	Bilgi Notu
TO7001 DEVE BOYNU SOL VE SAĞ	YEARS ONLY : HILUX : 1988-2005 / HIACE : 1999-2005 / PICK-UP : 1989-1995
VW1011K ROTİL ALT SAĞ-SOL Ø17 RD0514	WITH ENFORCEMENT METAL
VW1012K ROTİL ALT SAĞ-SOL 19 RD0515	WITH ENFORCEMENT METAL
VW1013K ROTİL	WITH ENFORCEMENT METAL
VW1014 ROTİL ÖN ALT SAĞ Ø15,6 RB2536	WITH ENFORCEMENT METAL
VW1021 ROTİL ÜST SAĞ-SOL RD0418	YEAR: 1996 -->
VW1022 ROTİL ALT SAĞ-SOL RD0517	YEAR: 1990-1996
VW1023 ROTİL ALT SAĞ-SOL RD0521	YEAR: 1996 -->
VW1028K ROTİL ALT SAĞ RD0523	WITH ENFORCEMENT METAL
VW1029K ROTİL ALT SOL RD0524	WITH ENFORCEMENT METAL
VW1051 ROTİL ALT SAĞ	FOR VEHICLES WITH ALUMINUM WHEEL BEARING
VW1051 ROTİL ALT SAĞ	FOR VEHICLES WITH ALUMINUM WHEEL BEARING
VW1052 ROTİL ALT SOL	FOR VEHICLES WITH ALUMINUM WHEEL BEARING
VW1052 ROTİL ALT SOL	FOR VEHICLES WITH ALUMINUM WHEEL BEARING
VW11019Y SALINCAK VE DENGE KOLU BURCU SOL VE SAĞ	SLOTTED
VW11043B SALINCAK VE DENGE KOLU BURCU SAĞ	WITHOUT BUSH
VW11044B SALINCAK VE DENGE KOLU BURCU SOL	WITHOUT BUSH

Ürün Kodu	Bilgi Notu
VW11052 SALINCAK VE DENGE KOLU BURCU ALT SOL VE SAĞ B22130	ONLY: A4 - A6 > 1,6-1,8 / PASSAT > 1,6 - 2,8 *
VW11055 SALINCAK VE DENGE KOLU BURCU İÇ SOL VE SAĞ	ONLY FOR MEXICO MARKET
VW11072 SALINCAK VE DENGE KOLU BURCU ALT SOL VE SAĞ	OUTER
VW11073 SALINCAK VE DENGE KOLU BURCU ÖN ALT SOL VE SAĞ	INNER
VW11075 SALINCAK VE DENGE KOLU BURCU ARKA SOL VE SAĞ	FORWARD and INNER
VW11076 SALINCAK VE DENGE KOLU BURCU ARKA SOL VE SAĞ	FORWARD and OUTER
VW11080 SALINCAK VE DENGE KOLU BURCU ÖN ALT	FOR STANDART TYPE CONTROL ARM
VW11081 SALINCAK VE DENGE KOLU BURCU ÖN ALT	FOR HEAVY DUTY TYPE CONTROL ARM
VW12011K BEŞİK (TRAVERS) BURCU ARKA SOL VE SAĞ VW12011	2 Pieces
VW12018K AMORTİSÖR TAKOZU SOL VE SAĞ AMORTİSÖR TAKOZU ÖN RULMANLI	WITH BEARING
VW12018R AMORTİSÖR TAKOZU SOL VE SAĞ AMORTİSÖR TAKOZU RULMANI	ONLY SUPPORT BEARING
VW12020K VİRAJ DEMİR LASTİĞİ SOL VE SAĞ RUBBER	2 PCS
VW12028 MOTOR TAKOZU SOL VE SAĞ MOTOR TAKOZU	1,4 TDI -1,6 TDI
VW12029 MOTOR TAKOZU SOL VE SAĞ MOTOR TAKOZU	1,4 TFSI -1,6 TFSI
VW12030 MOTOR TAKOZU SOL VE SAĞ MOTOR TAKOZU ARKA	1,6-1,8
VW12031 MOTOR TAKOZU SOL VE SAĞ MOTOR TAKOZU	A4: 2,4-2,8 / A6: 2,4 QUATTRO / SUPERB: 2,8 V6 / PASSAT: 2,8 V6
VW12032 MOTOR TAKOZU SOL VE SAĞ MOTOR TAKOZU	A3: 2,0 FSI / ALTEA: 2,0 FSI / TOLEDO: 2,0 FSI / OCTAVIA: 2,0 FSI / CADDY: 2,0 FSI / GOLF: 2,0 TDI / GTI: 2,0 TDI / JETTA: 2,0 TDI / PASSAT: 2,0 FSI / TOURAN: 2,0 FSI

Ürün Kodu	Bilgi Notu
VW12037K VİRAJ DEMİR LASTİĞİ SOL VE SAĞ RUBBER	2 PCS
VW12042K VİRAJ DEMİR LASTİĞİ SOL VE SAĞ RUBBER	2 PCS
VW12048K VİRAJ DEMİR LASTİĞİ SOL VE SAĞ RUBBER	2 PCS
VW12049K VİRAJ DEMİR LASTİĞİ SOL VE SAĞ RUBBER	2 PCS
VW12052K VİRAJ DEMİR LASTİĞİ SOL VE SAĞ RUBBER	2 PCS
VW12053K VİRAJ DEMİR LASTİĞİ SOL VE SAĞ RUBBER	2 PCS
VW12055 VİRAJ DEMİR LASTİĞİ SOL VE SAĞ RUBBER	1H0501541A
VW12059K VİRAJ DEMİR LASTİĞİ SOL VE SAĞ RUBBER	2 PCS
VW12061K AMORTİSÖR TAKOZU SOL VE SAĞ 2 PCS	2 PCS
VW12062K VİRAJ DEMİR LASTİĞİ SOL VE SAĞ RUBBER	2 PCS
VW12063K VİRAJ DEMİR LASTİĞİ SOL VE SAĞ RUBBER	2 PCS
VW12064K VİRAJ DEMİR LASTİĞİ SOL VE SAĞ RUBBER	2 PCS / D=Ø21mm
VW12064K VİRAJ DEMİR LASTİĞİ SOL VE SAĞ RUBBER	2 PCS / D=Ø21mm
VW12065K AMORTİSÖR TAKOZU ÖN SOL VE SAĞ 2 PCS	2 PCS
VW12068K TORSİYON BURCU ARKA SOL VE SAĞ	2 Pieces
VW12086 RADYATÖR TAKOZU SOL VE SAĞ RADYATÖR ÜST LASTİĞİ	FOR RADIATOR UPPER PART
VW12087K VİRAJ DEMİR LASTİĞİ SOL VE SAĞ RUBBER	2 PCS

Ürün Kodu	Bilgi Notu
VW12090K VİRAJ DEMİR LASTİĞİ SOL VE SAĞ RUBBER	2 PCS / D=Ø27mm
VW12091 MOTOR TAKOZU SOL VE SAĞ MOTOR TAKOZU	ONLY: 1.6LT
VW12104K AMORTİSÖR TAKOZU SOL VE SAĞ 2 PCS	2 PCS
VW12109K AMORTİSÖR TAKOZU SOL VE SAĞ 2 PCS	2 PCS
VW12111K VİRAJ DEMİR LASTİĞİ SOL VE SAĞ RUBBER	2 PCS
VW12112K VİRAJ DEMİR LASTİĞİ SOL VE SAĞ RUBBER	2 PCS
VW12113K Z-ROT BURCU ÖN SOL VE SAĞ RUBBER	2 PCS
VW12116K VİRAJ DEMİR LASTİĞİ SOL VE SAĞ RUBBER	2 PCS
VW12117K VİRAJ DEMİR LASTİĞİ SOL VE SAĞ RUBBER	2 PCS
VW12120 AMORTİSÖR TAKOZU ÖN SOL VE SAĞ AMORTİSÖR TAKOZU	DODGE SPRINTER 2500 and 3500 : 2007 - 2009
VW12120K AMORTİSÖR TAKOZU ÖN SOL VE SAĞ	DODGE SPRINTER 2500 and 3500 : 2007 - 2009 / 2 PCS
VW12130K Z-ROT BURCU ÖN	2 PIECES IN 1 BOX
VW12130K Z-ROT BURCU ÖN	2 PIECES IN 1 BOX
VW12131K Z-ROT BURCU ARKA	2 PIECES IN 1 BOX
VW12132K Z-ROT BURCU ÖN	2 PIECES IN 1 BOX
VW12133K ROTMİLİ BURCU VE LASTİĞİ ÖN	2 PIECES IN 1 BOX
VW12137 VİRAJ DEMİR LASTİĞİ	Ø17mm

Ürün Kodu	Bilgi Notu
VW12137K VİRAJ DEMİR LASTİĞİ	2 PIECES in 1 BOX / Ø17mm
VW12138K SÜSPANSİYON TAKOZU ARKA KİT	2 PIECES IN 1 BOX
VW12139 VİRAJ DEMİR LASTİĞİ	INTERNAL DIAMETER = Ø26.5mm
VW12139K VİRAJ DEMİR LASTİĞİ	2 PIECES IN 1 BOX / INTERNAL DIAMETER = Ø26.5mm
VW12140 VİRAJ DEMİR LASTİĞİ	INTERNAL DIAMETER = Ø20.5mm
VW12140K VİRAJ DEMİR LASTİĞİ	2 PIECES IN 1 BOX / INTERNAL DIAMETER = Ø20.5mm
VW12801 AMORTİSÖR TAKOZU SOL VE SAĞ KİT = VW12115 AND VW12109	KİT = VW12115 and VW12109
VW13002K DİREKSİYON KÖRÜĞÜ SOL VE SAĞ 2 PIECES	2 Pieces
VW13006K DİREKSİYON KÖRÜĞÜ SOL VE SAĞ 2 PIECES	2 Pieces
VW14001 AKS KÖRÜĞÜ +KELEPÇE+YAĞ. DIŞ	SET = BELOW, CLAMPING CLIP and MOLYBDENUM GREASE / OUTER
VW14003 AKS KÖRÜĞÜ +KELEPÇE+YAĞ. DIŞ	SET = BELOW, CLAMPING CLIP and MOLYBDENUM GREASE / OUTER
VW14004 AKS KÖRÜĞÜ +KELEPÇE+YAĞ. DIŞ	SET = BELOW, CLAMPING CLIP and MOLYBDENUM GREASE / OUTER
VW14005 AKS KÖRÜĞÜ +KELEPÇE+YAĞ. İÇ	SET = BELOW, CLAMPING CLIP and MOLYBDENUM GREASE / INNER
VW14006 AKS KÖRÜĞÜ +KELEPÇE+YAĞ. DIŞ	SET = BELOW, CLAMPING CLIP and MOLYBDENUM GREASE / OUTER
VW14007 AKS KÖRÜĞÜ +KELEPÇE+YAĞ. İÇ	SET = BELOW, CLAMPING CLIP and MOLYBDENUM GREASE / INNER
VW14008 AKS KÖRÜĞÜ +KELEPÇE+YAĞ. DIŞ	SET = BELOW, CLAMPING CLIP and MOLYBDENUM GREASE / OUTER
VW14009 AKS KÖRÜĞÜ +KELEPÇE+YAĞ. DIŞ	SET = BELOW, CLAMPING CLIP and MOLYBDENUM GREASE / OUTER

Ürün Kodu	Bilgi Notu
VW14010 AKS KÖRÜĞÜ +KELEPÇE+YAĞ. DIŞ	SET = BELOW, CLAMPING CLIP and MOLYBDENUM GREASE / OUTER
VW14011 AKS KÖRÜĞÜ +KELEPÇE+YAĞ. İÇ	SET = BELOW, CLAMPING CLIP and MOLYBDENUM GREASE / INNER
VW14012 AKS KÖRÜĞÜ +KELEPÇE+YAĞ. DIŞ	SET = BELOW, CLAMPING CLIP and MOLYBDENUM GREASE / OUTER
VW14013 AKS KÖRÜĞÜ +KELEPÇE+YAĞ. YAĞ+KELEPÇE	SET = BELOW, CLAMPING CLIP and MOLYBDENUM GREASE
VW14014 AKS KÖRÜĞÜ +KELEPÇE+YAĞ. YAĞ+KELEPÇE	SET = BELOW, CLAMPING CLIP and MOLYBDENUM GREASE
VW20033002 ROT TAKIMI SOL VE SAĞ	MANUAL STEERING
VW20033019 ROT TAKIMI ÖN AKS RD088145	POWER STEERING
VW20063003 ROT TAKIMI SAĞ RD088116	MANUAL STEERING
VW20063004 ROT TAKIMI ÖN AKS SAĞ	POWER STEERING
VW20063005 ROT TAKIMI ÖN AKS SAĞ RD088128	MANUAL STEERING
VW20063006 ROT TAKIMI ÖN AKS SAĞ RD088130	POWER STEERING
VW20063007 ROT TAKIMI ÖN AKS SAĞ RD088121	MANUAL STEERING
VW20063008 ROT TAKIMI ÖN AKS SAĞ RD088125	POWER STEERING
VW20063015 ROT TAKIMI ÖN AKS SAĞ RD088165	MANUAL STEERING
VW20063016 ROT TAKIMI ÖN AKS SAĞ RD088163	POWER STEERING
VW20073003 ROT TAKIMI SOL RD088115	MANUAL STEERING
VW20073004 ROT TAKIMI SOL RD088118	POWER STEERING

Ürün Kodu	Bilgi Notu
VW20073005 ROT TAKIMI ÖN AKS SOL RD088127	MANUAL STEERING
VW20073006 ROT TAKIMI ÖN AKS SOL RD088131	POWER STEERING
VW20073007 ROT TAKIMI ÖN AKS SOL RD088122	MANUAL STEERING
VW20073008 ROT TAKIMI SOL RD088124	POWER STEERING
VW20073015 ROT TAKIMI ÖN AKS SOL RD088166	MANUAL STEERING
VW20073016 ROT TAKIMI ÖN AKS SOL RD088145	POWER STEERING
VW2010 ROTBAŞI SAĞ RD0313	CH. NO: -->70-M-096448
VW20103011 ROT TAKIMI ÖN AKS SAĞ RD088173	CH. NO: -->70-M-096448
VW20103012 ROT TAKIMI ÖN AKS SAĞ RD088134	CH. NO: -->70-M-096448
VW2011 ROTBAŞI SOL RD0314	CH. NO: -->70-M-096448
VW20113011 ROT TAKIMI ÖN AKS SOL RD088133	CH. NO: -->70-M-096448
VW20113012 ROT TAKIMI ÖN AKS SOL RD088174	CH. NO: -->70-M-096448
VW2012 ROTBAŞI SAĞ RD0315	CH. NO: 70-M-096449-->
VW20123011 ROT TAKIMI ÖN AKS SAĞ RD088138	CH. NO: 70-M-096449-->
VW20123012 ROT TAKIMI ÖN AKS SAĞ RD088176	CH. NO: 70-M-096449-->
VW2013 ROTBAŞI SOL RD0316	CH. NO: 70-M-096449-->
VW20133011 ROT TAKIMI ÖN AKS SOL RD088137	CH. NO: 70-M-096449-->

Ürün Kodu	Bilgi Notu
VW20133012 ROT TAKIMI ÖN AKS SOL RD088175	CH. NO: 70-M-096449-->
VW2014 ROTBAŞI SAĞ	CH. NO: 70-T-200001-->
VW20143011 ROT TAKIMI ÖN AKS SAĞ RD088171	CH. NO: 70-T-200001-->
VW20143012 ROT TAKIMI ÖN AKS SAĞ RD088178	CH. NO: 70-T-200001-->
VW2015 ROTBAŞI SOL	CH. NO: 70-T-200001-->
VW20153011 ROT TAKIMI ÖN AKS SOL RD088172	CH. NO: 70-T-200001-->
VW20153012 ROT TAKIMI ÖN AKS SOL RD088177	CH. NO: 70-T-200001-->
VW2022 ROTBAŞI SAĞ RD0336	POWER STEERING
VW2023 ROTBAŞI SOL RD0335	POWER STEERING
VW2031 ROTBAŞI SAĞ	FOR VEHICLES WITH DYNAMIC STEERING
VW2032 ROTBAŞI SOL	FOR VEHICLES WITH DYNAMIC STEERING
VW3002 ROTMİLİ RD0811	MANUAL STEERING
VW3003 ROTMİLİ SAĞ-SOL RD0817	MANUAL STEERING
VW3004 ROTMİLİ ÖN SAĞ - SOL 338 RD0887	POWER STEERING
VW3005 ROTMİLİ SAĞ-SOL MANUEL 370 RD0829	MANUAL STEERING
VW3006 ROTMİLİ SAĞ-SOL HİDROLİK 360 RD0832	POWER STEERING
VW3007 ROTMİLİ ÖN SAĞ - SOL 369 RD0823	MANUAL STEERING

Ürün Kodu	Bilgi Notu
VW3008 ROTMİLİ SAĞ-SOL 371 RD0826	POWER STEERING
VW3011 ROTMİLİ SAĞ-SOL LASTİKSİZ 295 RD0836	-->1996
VW3012 ROTMİLİ SAĞ-SOL 295 RD0835	1996-->
VW3015 ROTMİLİ SAĞ-SOL HİDROLİK 309 RD0867	POWER STEERING
VW3016 ROTMİLİ SAĞ-SOL MANUEL 321 RD0864	MANUAL STEERING
VW3019 ROTMİLİ ÖN SAĞ - SOL	POWER STEERING
VW3019 ROTMİLİ ÖN SAĞ - SOL	POWER STEERING
VW4005 Z ROT ÖN SAĞ - SOL 19 MM RD0926	COMPLETE
VW4006 Z ROT ÖN SAĞ - SOL 19,8 MM RD0927	COMPLETE
VW4007 Z ROT ÖN SAĞ - SOL METAL 23MM RD0940	COMPLETE
VW4009 Z ROT ÖN SAĞ-SOL METAL 51 RD0911	ONLY: GTI
VW4012 Z ROT ÖN SAĞ METAL RD0937	CH. NO: -->OPT858
VW4013 Z ROT ÖN SOL METAL 340 RD0938	CH. NO: -->OPT858
VW4015K Z ROT SOL VE SAĞ METAL	WITH NUT and SCREW
VW4035 Z ROT ARKA PLASTİK	TRIM LEVEL : MULTILINK REAR AXLE
VW4038 Z ROT ARKA METAL	FOR 3.5T / FWD
VW4038K Z ROT ARKA METAL	FOR 3.5T / FWD / WITH ACCESSORIES

Ürün Kodu	Bilgi Notu
VW5001 SALINCAK ÖN	YEAR: -->1975
VW5002 SALINCAK ÖN	YEAR: 1976-->
VW5004 SALINCAK ARKA ÜST	FORWARD
VW60046005K SALINCAK ÖN	UNASSEMBLED BALL JOINT
VW60066007K SALINCAK ÖN	UNASSEMBLED BALL JOINT
VW600674008K SALINCAK ÖN	UNASSEMBLED BALL JOINT and LINK STABILIZER
VW6010 SALINCAK ÖN ALT SAĞ	YEAR: 1996 -->
VW6011 SALINCAK ÖN ALT SOL	YEAR: 1996 -->
VW60126013K SALINCAK ÖN	UNASSEMBLED BALL JOINT
VW6016 SALINCAK ÖN SAĞ RD10227	ONLY: GASOLINE
VW6016J SALINCAK ÖN ALT SAĞ S737	ONLY: GASOLINE
VW6017 SALINCAK ÖN SOL RD10226	ONLY: GASOLINE
VW6017J SALINCAK ÖN ALT SOL S738	ONLY: GASOLINE
VW6018 SALINCAK ÖN SAĞ RB30219	ONLY: DIESEL
VW6018J SALINCAK ÖN SAĞ RB30211	ONLY: DIESEL
VW6019 SALINCAK ÖN SOL RB30218	ONLY: DIESEL
VW6019J SALINCAK ÖN SOL RB30212	ONLY: DIESEL

Ürün Kodu	Bilgi Notu
VW6030 SALINCAK ÖN ALT SOL	YEAR: -->1996
VW6031 SALINCAK ÖN ALT SAĞ	YEAR: -->1996
VW6057 SALINCAK ALT SAĞ	UP TO 3,2T (MAX) / ONLY : T5 (2011 - 2016) and T6 (2016 -)
VW6058 SALINCAK ALT SOL	UP TO 3,2T (MAX) / ONLY : T5 (2011 - 2016) and T6 (2016 -)
VW6061 SALINCAK ALT SAĞ	MAX 2,6T & 3.0T
VW6062 SALINCAK ALT SOL	MAX 2,6T & 3.0T
VW6063 SALINCAK ÖN ALT SAĞ	1.0 TSI
VW6063 SALINCAK ÖN ALT SAĞ	1.0 TSI
VW6063J SALINCAK ÖN ALT SAĞ	1.0 TSI
VW6063J SALINCAK ÖN ALT SAĞ	1.0 TSI
VW6064 SALINCAK ÖN ALT SOL	1.0 TSI
VW6064 SALINCAK ÖN ALT SOL	1.0 TSI
VW6064J SALINCAK ÖN ALT SOL	1.0 TSI
VW6064J SALINCAK ÖN ALT SOL	1.0 TSI
VW6067 SALINCAK ALT SAĞ	RUSSIA MARKET / PORSCHE CAYENNE YEARS ONLY: 2008-2010 / VOLKSWAGEN TOUAREG YEARS ONLY: 2008-2010
VW6068 SALINCAK ALT SOL	RUSSIA MARKET / PORSCHE CAYENNE YEARS ONLY: 2008-2010 / VOLKSWAGEN TOUAREG YEARS ONLY: 2008-2010
VW6069 SALINCAK ALT SAĞ	FOR MAX 3,2 VEHICLE

Ürün Kodu	Bilgi Notu
VW6070 SALINCAK ALT SOL	FOR MAX 3,2 VEHICLE
VW6071 SALINCAK ALT SAĞ	STANDART TYPE
VW6072 SALINCAK ALT SOL	STANDART TYPE
VW6073 SALINCAK ALT SAĞ	HEAVY DUTY TYPE
VW6074 SALINCAK ALT SOL	HEAVY DUTY TYPE
VW6089 SALINCAK VE DENGE KOLU ÖN ALT SAĞ SAC LEVHA	FOR VEHICLES WITH ALUMINUM WHEEL BEARING
VW6090 SALINCAK VE DENGE KOLU ÖN ALT SOL SAC LEVHA	FOR VEHICLES WITH ALUMINUM WHEEL BEARING
VW8001 SÜSPANSİYON KİT ÖN	AU3001 (X2) / VW4011 (X2) / OTHERS (X1)
VW8002 SÜSPANSİYON KİT ÖN	VW3009 (X2) / VW4014 (X2) / OTHERS (X1)
VW8003 SÜSPANSİYON KİT ÖN	KIT = AU1014 (X1) / AU1015 (X1) / VW4011 (X2) / AU11002 (X2) / AU11005 (X2)
VW9005 SALINCAK ARKA ALT ÖNDEN	FORWARD
VW9015 SALINCAK VE DENGE KOLU ARKA METAL	FOR VEHICLES WITH ALUMINUM WHEEL BEARING